

 MITSUBISHI MATERIALS

# DREHWERKZEUGE



**DIA**  **EDGE**

**NEW**

# MITSUBISHI MATERIALS

## STELLT SEINEN NEUEN GESAMTKATALOG VOR: C009 - 2022/2023

### GEZIELT, KOMPAKT, HANDLICH:

Der neue Gesamtkatalog präsentiert nun das umfangreiche Produktsortiment von Mitsubishi Materials in einzelnen Anwendungsbereichen, um Nutzer einen schnelleren, individuellen Informationszugriff zu gewährleisten.

Eine Katalogsammlung im praktischen Kleinformat, die aus den folgenden fünf Bänden besteht:

- DREHWERKZEUGE
- BOHRWERKZEUGE
- VOLLHARTMETALL-FRÄSWERKZEUGE
- WENDEPLATTEN-FRÄSWERKZEUGE
- MPLUS



**NEUES DESIGN**

**EINFACHE HANDHABUNG**

**MEHR FLEXIBILITÄT**

**EINZELNE  
ANWENDUNGSBEREICHE**

Der mitgelieferte Schubler erleichtert die Aufbewahrung der Bücher und bietet Platz für alle weiteren Kataloge, die im Zeitraum 2022-2023 veröffentlicht werden, wie beispielsweise die Produktneuheiten. Fügen Sie die ergänzenden Kataloge in den vorgesehenen Platz im Schubler hinein, um die Sammlung zu erweitern oder ersetzen Sie ggf. die Kataloge durch die neuen Ausgaben.

### HINWEISE:

- Mit Erscheinen dieses Katalogs verlieren alle bisherigen Gesamt- und Neuheiten-Kataloge ihre Gültigkeit.
- Die Produktneuheiten erscheinen zweimal im Jahr, jeweils im April und Oktober.
- Der neue Gesamtkatalog kann nur als komplette Katalogsammlung (fünf Bände) bestellt werden.  
**Bestellnummer: C009D**



### DIGITALE VERSION

Für die digitale Version des Kataloges scannen Sie bitte den QR Code oder besuchen Sie uns unter [www.mhg-mediastore.net](http://www.mhg-mediastore.net)



# DREH- WERKZEUGE



## **QUALITÄT – HÖCHSTE STANDARDS BEI ALLEN PRODUKTEN UND DIENSTLEISTUNGEN**

Die Drehwerkzeuge von Mitsubishi Materials verkörpern diese Philosophie und überzeugen den Weltmarkt seit über 30 Jahren!

Mit ihrer Langlebigkeit, Leistung und Genauigkeit sind die Präzisionswerkzeuge von Mitsubishi Materials eine Bereicherung für die metallverarbeitende Industrie.

Ob Stechwerkzeug, ISO-Schneidplatte oder vibrationsarme Bohrstange – bei jedem einzelnen Drehwerkzeug aus unserem umfangreichen Sortiment steht Leistung an erster Stelle.

# DIA EDGE

## GEMEINSAM MIT UNSEREN KUNDEN

## AUF DEM WEG IN EINE SPANNENDE ZUKUNFT

Wir freuen uns, „DIAEDGE“, unsere neue Produktmarke für Hartmetallwerkzeuge, vorstellen zu dürfen. „DIAEDGE“ vereint all unsere innovativen Technologien, die seit Jahren unsere Kunden begeistern.

Unser Ziel ist es, Kunden weiterhin einen Mehrwert anzubieten, aber auch mit ihnen aktiv zusammenzuarbeiten, sich auszutauschen und von neuen Herausforderungen gegenseitig inspirieren zu lassen.



**MITSUBISHI MATERIALS**

# INHALT

## DREHWERKZEUGE



WSP DREHEN	<b>A001</b>
PCBN- & PKD-WSP FÜR DAS DREHEN	<b>B001</b>
DREHHALTER	<b>C001</b>
SMALL TOOLS	<b>D001</b>
BOHRSTANGEN	<b>E001</b>
EINSTECHEN UND ABSTECHEN	<b>F001</b>
GEWINDEDREHEN	<b>G001</b>
HSK-T WERKZEUGAUFNAHMEN	<b>H001</b>
ERSATZTEILE	<b>N001</b>
TECHNISCHE INFORMATIONEN	<b>P001</b>
INHALTSVERZEICHNIS	<b>1</b>
ALLGEMEINE INFORMATIONEN	

# ALLGEMEINE ERKLÄRUNG: DREHEN ÜBERSICHT DER WENDESCHNEIDPLATTEN

## ● Wie sind die Seiten dieses Kapitels aufgebaut

1. Aufgelistet nach der Form der Drehwendeplatte.  
(Beachten Sie das Inhaltsverzeichnis auf der nächsten Seite.)
2. Wendeschneidplatten sind aufgelistet nach :
  - Negative WSP (mit Loch→ohne Loch)
  - Positive WSP (mit Loch→ohne Loch)
3. Die Spanbrecher sind in folgender Reihenfolge aufgelistet :  
Schlichtzerspanung→Leichtzerspanung→Mittlere Zerspanung  
→Schruppzerspanung→Schwerzerspanung

## ● ÜBERSICHT DER SPANBRECHER FÜR DIV. MATERIALGRUPPEN

Zeigt den empfohlenen Spanbrecher und dessen Anwendungsbereich für die verschiedenen Werkstoffgruppen und Schnittdaten. Die Schaubilder zeigen farblich die verschiedenen Anwendungsbereiche (Schichten→Leicht→Mittlere Zersp.→Schruppen→Schwerzersp.) und beinhalten die empfohlenen Spanbrecher für jede Anwendung.

Schlichtzerspanung: — Leichtzerspanung: — Mittlere Zerspanung: —  
Schruppzerspanung: — Schwerzerspanung: —

### EMPFOLHENER SORTEN-ANWENDUNGSBEREICH FÜR DIE JEWEILIGEN WERKSTÜCKE

Geeignete Schnittbedingungen für unterschiedlichste Werkstücke werden in einer allg. Übersicht der Sorten dargelegt.

● : Stabile Bearbeitung ● : Allgemeine Bearbeitung ✦ : Instabile Bearbeitung

#### FORM & WINKEL

#### KLASSIFIZIERUNG OB NEGATIVE/POSITIVE AUSFÜHRUNG PRODUKTBEZEICHNUNGEN BEZUG AUF WSP-AUSFÜHRUNG

#### PRODUKT KAPITEL

#### WSP 80° CN AUSFÜHRUNG WSP MIT LOCH

CNMG 12 04 02- FP

#### ÜBERSICHT DER SPANBRECHER FÜR DIV. MATERIALGRUPPEN

Werkstoff	P	M	K	N	S
Form	Altp. Baustahl	C-Stahl	Leg. Stahl	Leg. Stahl	Leg. Stahl
FP	CNMG120402-FP	CNMG120404-FP	CNMG120408-FP	CNMG120412-FP	
FH	CNMG120402-FH	CNMG120404-FH	CNMG120408-FH	CNMG120412-FH	
FS	CNMG120404-FS	CNMG120408-FS			
FY	CNMG120404-FY	CNMG120408-FY			
FJ	CNMG120404-FJ	CNMG120408-FJ			
LP	CNMG120404-LP	CNMG120408-LP	CNMG120412-LP		
LM	CNMG120404-LM	CNMG120408-LM	CNMG120412-LM		

#### WSP-BEZEICHNUNG

#### LAGERSTATUS

#### WSP-SORTEN

Werkstoff	P	M	K	N	S
Form	Altp. Baustahl	C-Stahl	Leg. Stahl	Leg. Stahl	Leg. Stahl
LK	CNMG120404-LK	CNMG120408-LK	CNMG120412-LK		
LS	CNMG090304-LS	CNMG090308-LS	CNMG120402-LS		
SH	CNMG120408-SH	CNMG09T304-SH	CNMG09T308-SH		
SA	CNMG120404-SA	CNMG120408-SA	CNMG120412-SA		
SW	CNMG120404-SW	CNMG120408-SW	CNMG120412-SW		
SY	CNMG120404-SY	CNMG120408-SY			
MJ	CNMG120404-MJ	CNMG120408-MJ	CNMG120412-MJ	CNMG120416-MJ	

A098 ● : Lagerstandard. \* : Lagerstandard in Japan.  
○ : Nichtstandard, Herstellung nur auf Anfrage.

SPANBRECHER > A098  
SORTEN > A099  
IDENTIFIKATION > A097

**LEGENDE FÜR LAGERSYMBOLLE**  
Wird auf jeder Doppelseite auf der linken Seite gezeigt.

**ANWENDUNGSBEREICH**  
Wird aufgelistet in : Schichten→Leicht→  
Mittlere Zersp.→Schruppen→Schwerzersp.

**ABBILDUNG DER WSP**

**KLASSIFIZIERUNG DES SPANBRECHERS**  
Gibt Aufschluß über den Anwendungsbereich des Spanbrechers.

**QUERVERWEIS AUF ANDERE SEITEN**  
· SPANBRECHER  
· SORTEN  
· TECHNISCHE DATEN  
Wird als Querverweis auf der rechten Seite einer jeden Doppelseite angezeigt.

**ZUGEHÖRIGER HALTER/SEITE**  
Die Seite zeigt den Querverweis auf die jeweils zugehörigen Halter.

**ECKENRADIUS (RE)**

● Für die Bestellung: Bitte Folgendes angeben:

1. Artikelbezeichnung und 2. Sorte der Wendeschneidplatte.

DREHEN

# WSP SORTEN

## ÜBERSICHT DER WENDESCHNEIDPLATTEN

IDENTIFIKATION .....	A002
LOCHGEOMETRIE .....	A004
PRÄZISIONSSPANBRECHER .....	A006
TOOL NAVI .....	A009
SPANBRECHER EMPFEHLUNG .....	A010
PRÄZISIONSSPANBRECHER .....	A026
BREITSCHLICHT-WSP .....	A028
SORTENÜBERSICHT DREHEN .....	A030
DREHEN ANWENDUNGSBEREICH .....	A031
BESCHICHTETES HARTMETALL (CVD) .....	A034
BESCHICHTETES HARTMETALL (PVD) .....	A036
CERMET .....	A038
BESCHICHTETES CERMET .....	A039
HARTMETALL .....	A040
KLASSIFIZIERUNG .....	A042
SCHNITTDATENEMPFEHLUNGEN .....	A074

### WENDESCHNEIDPLATTEN DREHEN

#### NEGATIVE WSP MIT LOCH

CN<sup>0</sup>AUSFÜHRUNG...RHOMBUS 80°... A098  
DN<sup>0</sup>AUSFÜHRUNG...RHOMBUS 55°... A105  
RN<sup>0</sup>AUSFÜHRUNG...RUND... A112  
SN<sup>0</sup>AUSFÜHRUNG...VIERKANT 90°... A113  
TN<sup>0</sup>AUSFÜHRUNG...DREIKANT 60°... A119  
VN<sup>0</sup>AUSFÜHRUNG...RHOMBUS 35°... A126  
WN<sup>0</sup>AUSFÜHRUNG...SECHSKANT 80°... A130

#### NEGATIVE WSP OHNE LOCH

KN<sup>0</sup>AUSFÜHRUNG...PARALLELOGRAMM 55°... A135  
CN<sup>0</sup>AUSFÜHRUNG...RHOMBUS 80°... A136  
SN<sup>0</sup>AUSFÜHRUNG...VIERKANT 90°... A137  
TN<sup>0</sup>AUSFÜHRUNG...DREIKANT 60°... A138

#### POSITIVE WENDESCHNEIDPLATTEN MIT LOCH

CC<sup>0</sup>AUSFÜHRUNG...RHOMBUS 80°... A139  
CP<sup>0</sup>AUSFÜHRUNG...RHOMBUS 80°... A146  
DC<sup>0</sup>AUSFÜHRUNG...RHOMBUS 55°... A147  
DE<sup>0</sup>AUSFÜHRUNG...RHOMBUS 55°... A153  
RC<sup>0</sup>AUSFÜHRUNG...RUND... A154

SC<sup>0</sup>AUSFÜHRUNG...VIERKANT 90°... A155  
SP<sup>0</sup>AUSFÜHRUNG...VIERKANT 90°... A157  
TC<sup>0</sup>AUSFÜHRUNG...DREIKANT 60°... A158  
TE<sup>0</sup>AUSFÜHRUNG...DREIKANT 60°... A161  
TP<sup>0</sup>AUSFÜHRUNG...DREIKANT 60°... A162  
VB<sup>0</sup>AUSFÜHRUNG...RHOMBUS 35°... A164  
VC<sup>0</sup>AUSFÜHRUNG...RHOMBUS 35°... A167  
VD<sup>0</sup>AUSFÜHRUNG...RHOMBUS 35°... A170  
VP<sup>0</sup>AUSFÜHRUNG...RHOMBUS 35°... A171  
WB<sup>0</sup>AUSFÜHRUNG...SECHSKANT 80°... A172  
WC<sup>0</sup>AUSFÜHRUNG...SECHSKANT 80°... A173  
WP<sup>0</sup>AUSFÜHRUNG...SECHSKANT 80°... A174  
XC<sup>0</sup>AUSFÜHRUNG...RHOMBUS 25°... A175

#### POSITIVE WENDESCHNEIDPLATTEN OHNE LOCH

RTG AUSFÜHRUNG..... A176  
SP<sup>0</sup>AUSFÜHRUNG...VIERKANT 90°... A177  
TC<sup>0</sup>AUSFÜHRUNG...DREIKANT 60°... A179  
TP<sup>0</sup>AUSFÜHRUNG...DREIKANT 60°... A180

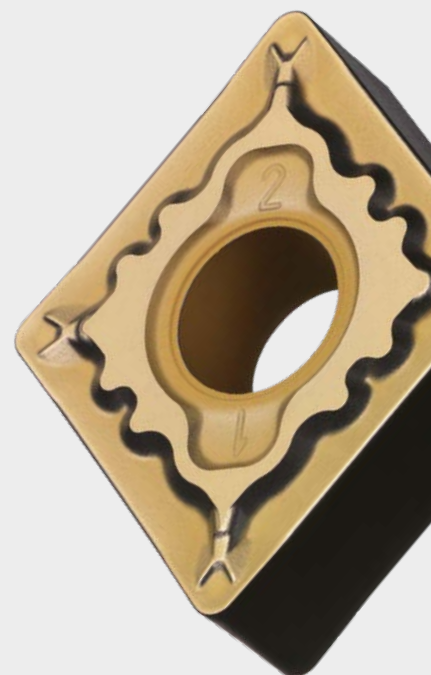



# IDENTIFIKATION

WSP DREHEN

Symbol	WSP Form	
H	Sechskant	
O	Achtkant	
P	Fünfkant	
S	Vierkant	
T	Dreikant	
C	Rhombus 80°	
D	Rhombus 55°	
E	Rhombus 75°	
F	Rhombus 50°	
M	Rhombus 86°	
V	Rhombus 35°	
W	Sechskant	
L	Rechteck	
A	Parallelogramm 85°	
B	Parallelogramm 82°	
K	Parallelogramm 55°	
R	Rund	
X	Spezielles Design	

① Symbol für die Form

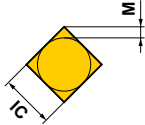
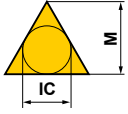
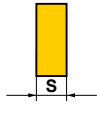
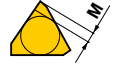
Dreikant WSP mit Seitenschnitte (Nebenschnitte)

③ Symbol für Toleranzgruppen				Detailtoleranzen für M-Klasse-WSP						
Symbol	Toleranz ohne Radius M (mm)	Toleranz des Innkreises IC (mm)	Dickentoleranz S (mm)	● Toleranz ohne Radius M (mm)						
				Innenkreis	Dreikant	Vierkant	Rhombus 80°	Rhombus 55°	Rhombus 35°	Rund
A	±0.005	±0.025	±0.025	6.35	±0.08	±0.08	±0.08	±0.11	±0.16	—
F	±0.005	±0.013	±0.025	9.525	±0.08	±0.08	±0.08	±0.11	±0.16	—
C	±0.013	±0.025	±0.025	12.70	±0.13	±0.13	±0.13	±0.15	—	—
H	±0.013	±0.013	±0.025	15.875	±0.15	±0.15	±0.15	±0.18	—	—
E	±0.025	±0.025	±0.025	19.05	±0.15	±0.15	±0.15	±0.18	—	—
G	±0.025	±0.025	±0.13	25.40	—	±0.18	—	—	—	—
J	±0.005	±0.05—±0.15	±0.025	31.75	—	±0.20	—	—	—	—
K*	±0.013	±0.05—±0.15	±0.025	● Toleranz des Innkreises (mm)						
L*	±0.025	±0.05—±0.15	±0.025	Innenkreis	Dreikant	Vierkant	Rhombus 80°	Rhombus 55°	Rhombus 35°	Rund
M*	±0.08—±0.18	±0.05—±0.15	±0.13	6.35	±0.05	±0.05	±0.05	±0.05	±0.05	—
N*	±0.08—±0.18	±0.05—±0.15	±0.025	9.525	±0.05	±0.05	±0.05	±0.05	±0.05	±0.05
U*	±0.13—±0.38	±0.08—±0.25	±0.13	12.70	±0.08	±0.08	±0.08	±0.08	—	±0.08
Die * Markierung bezeichnet gesinterte Wendeschneidplatten.				15.875	±0.10	±0.10	±0.10	±0.10	—	±0.10
				19.05	±0.10	±0.10	±0.10	±0.10	—	±0.10
				25.40	—	±0.13	—	—	—	±0.13
				31.75	—	±0.15	—	—	—	±0.15

③ Symbol für Toleranzgruppen

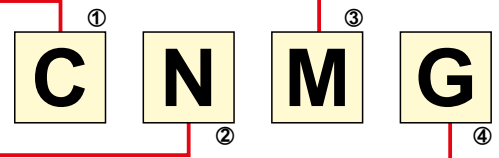

② Freiwinkelsymbol	
Symbol	Standard Freiwinkel
A	3°
B	5°
C	7°
D	15°
E	20°
F	25°
G	30°
N	0°
P	11°
O	Weitere Freiwinkel
Hauptfreiwinkel	

④ Befestigungs- und/oder Spanbrechersymbol									
Metrisch									
Symbol	Loch	Loch Konfiguration	Spanbrecher	Abbildung	Symbol	Loch	Loch Konfiguration	Spanbrecher	Abbildung
W	Mit Loch	Zylindrisches Loch + Senkung einseitig (40–60°)	Nein		A	Mit Loch	Zylindrisches Loch	Nein	
T	Mit Loch	Zylindrisches Loch + Senkung doppelseitig (40–60°)	Einseitig		M	Mit Loch	Zylindrisches Loch	Einseitig	
Q	Mit Loch		Nein		G	Mit Loch	Zylindrisches Loch	Doppelseitig	
U	Mit Loch	Zylindrisches Loch + Senkung einseitig (70–90°)	Doppelseitig		N	Ohne Loch	—	Nein	
B	Mit Loch		Nein		R	Ohne Loch	—	Einseitig	
H	Mit Loch	Zylindrisches Loch + Senkung doppelseitig (70–90°)	Einseitig		F	Ohne Loch	—	Doppelseitig	
C	Mit Loch		Nein		X	—	—	—	Spezielles Design
J	Mit Loch		Doppelseitig						



Symbol							Innenkreis- durchmesser (mm)
R	W	V	D	C	S	T	
	02		04	03	03	06	3.97
	L3	08	05	04	04	08	4.76
	03	09	06	05	05	09	5.56
06							6.00
	04	11	07	06	06	11	6.35
	05	13	09	08	07	13	7.94
08							8.00
09	06	16	11	09	09	16	9.525
10							10.00
12							12.00
	08	22	15	12	12	22	12.70
15	10		19	16	15	27	15.875
16							16.00
19	13		23	19	19	33	19.05
20							20.00
			27	22	22	38	22.225
25							25.00
25			31	25	25	44	25.40
31			38	32	31	54	31.75
32							32.00

**⑤ Referenz über die Wendeschneidplattengröße**

\*Die Dicke wird von der Auflagefläche der WSP bis zur Schneidkante gemessen.

Symbol	Dicke (mm)
S1	1.39
01	1.59
T0	1.79
02	2.38
T2	2.78
03	3.18
T3	3.97
04	4.76
06	6.35
07	7.94
09	9.52

**⑥ Referenz über Dicke**

⑤ 12
 ⑥ 04
 ⑦ 08
 ⑧ (E)
 ⑨ (N)-
 ⑩ MP

**⑦ Bestimmung des Eckenradius**

Symbol	Eckenradius (mm)
00	Ohne Radius
V3	0.03
V5	0.05
01	0.1
02	0.2
04	0.4
08	0.8
12	1.2
16	1.6
20	2.0
24	2.4
28	2.8
32	3.2

00 : Zoll  
MO : Metrisch

Runde WSP

**⑧ Schneidkantenausführung**

Abbildung	Schneidkante	Symbol
	Scharfkantig	F
	Verrundete Schneidkante	E
	Verfaste Schneidkanten	T
	Verfaste und verrundete Schneidkanten	S
-	(-) Eckenradius-Toleranz	M

Mitsubishi Materials gibt das Schneidkantensymbol nicht an.

**⑨ Bearbeitungsrichtung**

Abbildung	Richtung	Symbol
	Rechts	R
	Links	L
	Neutral	N

**⑩ Symbol für Spanbrecherform**

LP	MP	RP
LM	MM	RM
LK	MK	RK
LS	MS	RS
FP	LP	MP
MA	SW	MW
HZ	HX	HV

Die obige Tabelle dient zu Referenzzwecken.

# LOCHGEOMETRIE

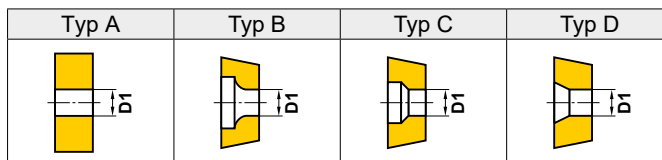

## NEGATIV

WSP Bezeichnung	Abmessungen (mm)		Lochtyp	
	D1			
CNGA CNGG CNGM CNMA CNMG CNMM CNMP	0903	3.81	A	
	09T3	3.81	A	
	0904	3.81	A	
	1204	5.16	A	
	1606	6.35	A	
	1906	7.93	A	
	2509	9.12	A	
	DNGA DNGG DNGM DNMA DNMG DNMM DNMX	1104	3.81	A
		1504	5.16	A
1506		5.16	A	
SNGA SNGG SNMA SNMG SNMM		0903	3.81	A
		1204	5.16	A
		1506	6.35	A
	1906	7.93	A	
	2507	9.12	A	
2509	9.12	A		
TNGA TNGG TNGM TNMA TNMG TNMM TNMX	1103	2.26	A	
	1603	3.81	A	
	1604	3.81	A	
	2204	5.16	A	
	2706	6.35	A	
	3309	7.93	A	
	VNGA VNGM VNGG VNMA VNMG VNMM	1604	3.81	A
		WNGA WNMA WNMG	0603	3.81
06T3			3.81	A
0604			3.81	A
0804			5.16	A
1006			6.35	A
RNMG	090300	3.81	A	
	120400	5.16	A	
	150600	6.35	A	
	190600	7.93	A	
	250900	9.12	A	
	310900	12.7	A	

## POSITIV

WSP Bezeichnung	Abmessungen (mm)		Lochtyp	
	D1			
CCET	0602	2.8	B	
	09T3	4.4	B	
CCGB CCMB CCGH CCMH	0602	2.8	B	
	CCGT	03S1	2.0	B
		04T0	2.4	B
		0602	2.8	B
09T3		4.4	B	
CCMT	1204	5.5	B	
	0602	2.8	B	
	0803	3.4	B	
	09T3	4.4	B	
CCGW CCMW	1204	5.5	B	
	03S1	2.0	B	
	04T0	2.4	B	
	0602	2.8	B	
	09T3	4.4	B	
CPGT	1204	5.5	B	
	0802	3.4	B	
CPGB CPMB CPMH	0903	4.4	B	
	CPMX	0802	3.5	D
		0903	4.5	D
0802		3.5	D	
DCET DCGT	0903	4.6	D	
	0702	2.8	B	
DCGW DCMW DCMT	11T3	4.4	B	
	0702	2.8	B	
	11T3	4.4	B	
DEGX	1504	5.5	B	
	1504	5.1	C	
	RCMX	1003M0	3.6	D
		1204M0	4.2	D
1606M0		5.2	D	
2006M0		6.5	D	
2507M0		7.2	D	
3209M0	9.5	D		

A

WSP DREHEN

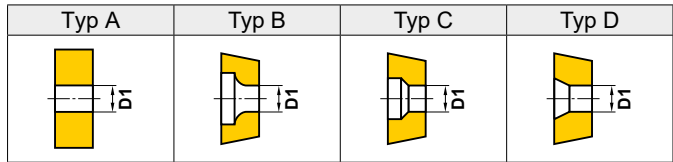

## POSITIV

WSP Bezeichnung		Abmessungen (mm)	
		D1	Lochtyp
RCGT RCMT	0602M0	2.8	B
	0803M0	3.4	B
	10T3M0	4.4	B
SCMT SCMW	09T3 $\odot\odot$	4.4	B
	1204 $\odot\odot$	5.5	B
SPMW	0903 $\odot\odot$	4.6	B
	1203 $\odot\odot$	5.7	B
SPMT	0903 $\odot\odot$	4.4	B
	1203 $\odot\odot$	5.5	B
SPGX	0903 $\odot\odot$	4.8	D
	1203 $\odot\odot$	5.9	D
TCGT TCMT TCGW TCMW	0601 $\odot\odot$	2.3	B
	0802 $\odot\odot$	2.3	B
	0902 $\odot\odot$	2.5	B
	1102 $\odot\odot$	2.8	B
	1303 $\odot\odot$	3.4	B
16T3 $\odot\odot$	4.4	B	
TEGX	1603 $\odot\odot$	4.4	D
TPGX	0802 $\odot\odot$	2.5	C
	0902 $\odot\odot$	3.0	C
	1103 $\odot\odot$	3.5	C
	1603 $\odot\odot$	4.8	D
TPMX	0802 $\odot\odot$	2.7	C
	0902 $\odot\odot$	3.2	C
	1103 $\odot\odot$	3.7	C
	1103 $\odot\odot$ L	3.5	C
	1603 $\odot\odot$	4.8	D
TPGB TPMB TPGH TPMH	0802 $\odot\odot$	2.4	D
	0902 $\odot\odot$	2.9	D
	1103 $\odot\odot$	3.4	D
	1603 $\odot\odot$	4.4	D
TPGT	1603 $\odot\odot$	4.4	B
TPGV	0902 $\odot\odot$	2.8	B
	1103 $\odot\odot$	3.4	B

WSP Bezeichnung		Abmessungen (mm)	
		D1	Lochtyp
VBET VBGT VBMT VBGW	1103 $\odot\odot$	2.9	B
	1604 $\odot\odot$	4.4	B
VCGT VCMT VCGW VCMW	0802 $\odot\odot$	2.4	B
	1103 $\odot\odot$	2.8	B
	1303 $\odot\odot$	3.4	B
	1604 $\odot\odot$	4.4	B
VDGX	1603 $\odot\odot$	4.5	D
VPET VPGT	0802 $\odot\odot$	2.42	B
	1103 $\odot\odot$	2.85	B
WGBT WBMT	0201 $\odot\odot$	2.3	B
	L302 $\odot\odot$	2.3	B
WCGT WCMT WCGW WCMW	0201 $\odot\odot$	2.3	B
	L302 $\odot\odot$	2.3	B
	0402 $\odot\odot$	2.8	B
	06T3 $\odot\odot$	4.4	B
WPGT WPMT	0402 $\odot\odot$	2.8	B
	0603 $\odot\odot$	4.4	B
XCMT	1503 $\odot\odot$	2.8	B

A

WSP DREHEN



# PRÄZISIONSSPANBRECHER

## WENDESCHNEIDPLATTEN - STANDARD

### ● NEGATIVE WENDESCHNEIDPLATTEN



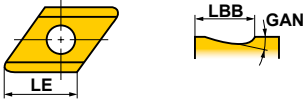
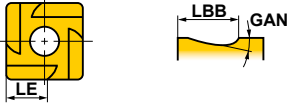
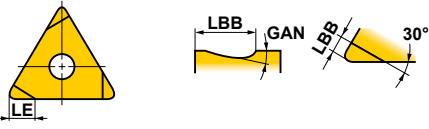
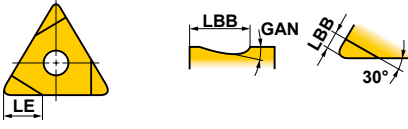
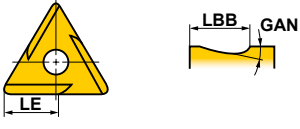
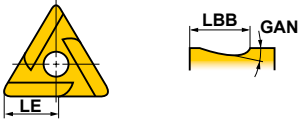





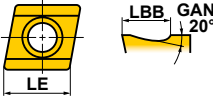

Maße : mm

A  
WSP DREHEN

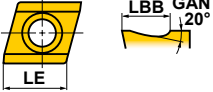
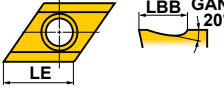
Abbildung	WSP Bezeichnung	LBB	LE	GAN
 <p>Abbildung zeigt rechte WSP.</p>	DNGG150404R/L	2.8	14.9	15°
	DNGG150408R/L	2.8	14.3	15°
	DNGG150604R/L	2.8	14.9	15°
	DNGG150608R/L	2.8	14.3	15°
 <p>Abbildung zeigt rechte WSP.</p>	SNGG090304R/L	1.8	1.6	15°
	SNGG090308R/L	1.8	1.6	15°
	SNGG120404R/L	2.3	3.7	15°
	SNGG120408R/L	2.3	3.7	15°
 <p>Abbildung zeigt rechte WSP.</p>	TNGG160402R/L-FS	1.3	2.7	15°
	TNGG160404R/L-FS	1.3	2.8	15°
	TNGG160408R/L-FS	1.3	3.1	15°
 <p>Abbildung zeigt rechte WSP.</p>	TNGG160402R/L-F	2.5	5.1	15°
	TNGG160404R/L-F	2.5	5.2	15°
	TNGG160408R/L-F	2.5	5.5	15°
 <p>Abbildung zeigt rechte WSP.</p>	TNGG160402R/L-K	1.5	7.1	15°
	TNGG160404R/L-K	1.5	5.4	15°
	TNGG160408R/L-K	1.5	5.1	15°
 <p>Abbildung zeigt rechte WSP.</p>	TNGG110302R/L	1.3	3.2	15°
	TNGG110304R/L	1.3	3.0	15°
	TNGG110308R/L	1.3	2.7	15°
	TNGG160304R/L	2.3	5.4	15°
	TNGG160402R/L	1.3	8.7	15°
	TNGG160404R/L	2.3	5.4	15°
	TNGG160408R/L	2.3	5.1	15°
	TNGG220404R/L	2.8	9.4	15°
TNGG220408R/L	2.8	9.1	15°	
 <p>Abbildung zeigt rechte WSP.</p>	VNGG160404R/L	1.8	15.6	15°
 <p>Abbildung zeigt rechte WSP.</p>	VNGG160402R/L-F	2.5	7.4	15°
	VNGG160404R/L-F	2.5	7.6	15°

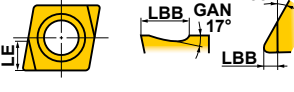
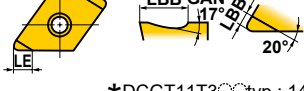
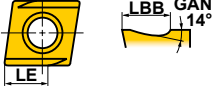
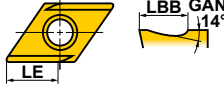
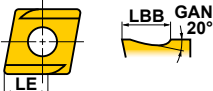
# ● POSITIVE WENDESCHNEIDPLATTEN

Maße : mm

Abbildung	WSP Bezeichnung	LBB	LE	Abbildung	WSP Bezeichnung	LBB	LE
 <p>Abbildung zeigt rechte WSP.</p>	CCET0602V3R/L-SR	2.2	6.4	 <p>Abbildung zeigt rechte WSP.</p>	DCGT11T301MR-SRF	1.0	3.1
	CCET060201R/L-SR	2.2	6.3		DCGT11T302MR-SRF	1.0	3.2
	CCET060202R/L-SR	2.2	6.2		DCGT11T304MR-SRF	1.0	3.4
	CCET060204R/L-SR	2.2	6.0				
	CCET09T3V3R/L-SR	3.2	9.6				
	CCET09T301R/L-SR	3.2	9.5				
	CCET09T302R/L-SR	3.2	9.4				
CCET09T304R/L-SR	3.2	9.2					
 <p>Abbildung zeigt rechte WSP.</p>	CCET060200R/L-SN	1.0	6.4	 <p>Abbildung zeigt rechte WSP.</p>	DCET0702V3R/L-SR	2.5	7.7
	CCET0602V3R/L-SN	1.0	6.4		DCET070201R/L-SR	2.5	7.6
	CCET060201R/L-SN	1.0	6.3		DCET070202R/L-SR	2.5	7.4
	CCET060202R/L-SN	1.0	6.2		DCET070204R/L-SR	2.5	7.1
	CCET060204R/L-SN	1.0	6.0		DCET11T3V3R/L-SR	3.7	11.6
	CCET09T300R/L-SN	1.5	9.6		DCET11T301R/L-SR	3.7	11.4
	CCET09T3V3R/L-SN	1.5	9.6		DCET11T302R/L-SR	3.7	11.3
	CCET09T301R/L-SN	1.5	9.5		DCET11T304R/L-SR	3.7	11.0
	CCET09T302R/L-SN	1.5	9.4				
	CCET09T304R/L-SN	1.5	9.2				
	CCET0602V3R/LW-SN	1.0	6.4				
CCET09T3V3R/LW-SN	1.5	9.6					
 <p>Abbildung zeigt rechte WSP.</p>	CCGH060202(M)R/L-F	1.2	3.6	 <p>Abbildung zeigt rechte WSP.</p>	DCET070200R/L-SN	1.0	7.7
	CCGH060204(M)R/L-F	1.4	4.4		DCET0702V3R/L-SN	1.0	7.7
					DCET070201R/L-SN	1.0	7.6
					DCET070202R/L-SN	1.0	7.4
					DCET070204R/L-SN	1.0	7.1
					DCET11T300R/L-SN	1.5	11.6
					DCET11T3V3R/L-SN	1.5	11.6
					DCET11T301R/L-SN	1.5	11.4
					DCET11T302R/L-SN	1.5	11.3
					DCET11T304R/L-SN	1.5	11.0
 <p>Abbildung zeigt rechte WSP.</p>	CCGT03S1V3L-F	0.8	1.4	 <p>Abbildung zeigt rechte WSP.</p>	DCET0702V3R/LW-SN	1.0	7.7
	CCGT03S101(M)R/L-F	0.8	1.4		DCET11T3V3R/LW-SN	1.5	11.6
 <p>Abbildung zeigt linke WSP.</p>	CCGT03S102(M)R/L-F	0.8	1.5	 <p>Abbildung zeigt rechte WSP.</p>	DCGT070202R/L-F	1.0	3.0
	CCGT03S104(M)R/L-F	0.8	1.6		DCGT070204R/L-F	1.0	3.2
	CCGT04T0V3L-F	1.0	1.7		DCGT11T302R/L-F	1.0	3.0
	CCGT04T001(M)R/L-F	1.0	1.8		DCGT11T304R/L-F	1.0	3.2
	CCGT04T002(M)R/L-F	1.0	1.8				
	CCGT04T004(M)R/L-F	1.0	2.0				
 <p>Abbildung zeigt rechte WSP.</p>	CCGT0602V3R/L-SS	1.0	3.0	 <p>Abbildung zeigt rechte WSP.</p>	DCGT070202R/L-SS	1.0	3.5
	CCGT060201(M)R/L-SS	1.0	3.0		DCGT070201R/L-SS	1.0	3.5
	CCGT060202(M)R/L-SS	1.0	3.0		DCGT070202(M)R/L-SS	1.0	3.5
	CCGT09T3V3R/L-SS	1.0	5.0		DCGT11T3V3R-SS	1.0	6.5
	CCGT09T301(M)R/L-SS	1.0	5.0		DCGT11T301(M)R/L-SS	1.0	6.5
	CCGT09T302(M)R/L-SS	1.0	5.0		DCGT11T302(M)R/L-SS	1.0	6.5
	CCGT09T304MR/L-SS	1.0	5.0		DCGT11T304MR/L-SS	1.0	6.5
 <p>Abbildung zeigt rechte WSP.</p>	CCGT0602V3R-SN	1.0	3.0	 <p>Abbildung zeigt rechte WSP.</p>	DCGT0702V3R-SN	1.0	3.5
	CCGT060201(M)R/L-SN	1.0	3.0		DCGT070201(M)R/L-SN	1.0	3.5
	CCGT060202(M)R/L-SN	1.0	3.0		DCGT070202(M)R/L-SN	1.0	3.5
	CCGT09T3V3R/L-SN	1.5	5.0		DCGT11T3V3R/L-SN	1.5	6.5
	CCGT09T301(M)R/L-SN	1.5	5.0		DCGT11T301(M)R/L-SN	1.5	6.5
	CCGT09T302(M)R/L-SN	1.5	5.0		DCGT11T302(M)R/L-SN	1.5	6.5
	CCGT09T304(M)R/L-SN	1.5	5.0		DCGT11T304(M)R/L-SN	1.5	6.5
 <p>Abbildung zeigt rechte WSP.</p>	CPGT080204R/L-F	1.8	5.5	 <p>Abbildung zeigt rechte WSP.</p>	DEGX150402R/L	2.8	15.2
	CPGT090302R/L-F	1.8	5.4		DEGX150404R/L	2.8	14.9
	CPGT090304R/L-F	1.8	5.5				

A  
WSP DREHEN

# PRÄZISIONSSPANBRECHER

## WENDESCHNEIDPLATTEN - STANDARD

### ● POSITIVE WENDESCHNEIDPLATTEN

Maße : mm

WSP DREHEN

A

Abbildung	WSP Bezeichnung	LBB	LE	Abbildung	WSP Bezeichnung	LBB	LE
 Abbildung zeigt rechte WSP.	DEGX150402R/L-F DEGX150404R/L-F	2.5 2.5	7.4 7.6	 Abbildung zeigt rechte WSP.	VBGT110302R/L-F VBGT110304R/L-F VBGT160402R/L-F VBGT160404R/L-F	1.0 1.0 1.5 1.5	3.0 3.2 4.5 4.7
 Abbildung zeigt rechte WSP.	SPGR090304R	1.8	1.6	 Abbildung zeigt rechte WSP.	VBET1103V3R/L-SR VBET110301R/L-SR VBET110302R/L-SR VBET110304R/L-SR	2.5 2.5 2.5 2.5	7.3 7.3 7.4 7.6
 Abbildung zeigt linke WSP.	TCGT0601V3L-F TCGT060101L-F TCGT060102R/L-F TCGT060104R/L-F	1.0 1.0 1.0 1.0	2.9 3.0 3.0 3.2	 Abbildung zeigt rechte WSP.	VBET110300R/L-SN VBET1103V3R/L-SN VBET110301R/L-SN VBET110302R/L-SN VBET110304R/L-SN	1.0 1.0 1.0 1.0 1.0	11.0 11.0 10.8 10.5 11.0
 Abbildung zeigt rechte WSP.	TEGX160302R/L TEGX160304R/L	2.0 2.0	6.0 6.0	 Abbildung zeigt rechte WSP.	VBET1103V3R/LW-SN	1.0	11.0
 Abbildung zeigt rechte WSP.	TPGH080202R/L-FS TPGH080204R/L-FS TPGH090202R/L-FS TPGH090204R/L-FS TPGH110302R/L-FS TPGH110304R/L-FS *TPGH160300typ : 14° TPGH160304R/L-FS TPGH160308R/L-FS	0.9 0.9 1.0 1.0 1.4 1.4 2.0 2.0	2.7 2.9 3.0 3.2 4.2 4.4 6.1 6.5	 Abbildung zeigt rechte WSP.	VCGT080202R/L-F VCGT080204R/L-F	0.8 0.8	2.5 2.6
 Abbildung zeigt rechte WSP.	TPGR110304R/L TPGR160304R/L TPGR160308R/L	1.3 2.3 2.3	3.0 5.4 5.1	 Abbildung zeigt rechte WSP.	VDBG160302R/L VDBG160304R/L	2.0 2.0	6.0 6.1
 Abbildung zeigt rechte WSP.	TPGX080202R/L TPGX080204R/L TPGX090202R/L TPGX090204R/L TPGX090208R/L TPGX110302L TPGX110304R/L TPGX110308R/L	1.3 1.3 1.6 1.6 1.4 1.8 1.8 1.8	3.9 4.1 4.8 5.0 4.7 5.4 5.5 5.9	 Abbildung zeigt rechte WSP.	VPET080201R/L-SRF VPET080202R/L-SRF VPET1103V3R/L-SRF VPET110301R/L-SRF VPET110302R/L-SRF	0.8 0.8 1.0 1.0 1.0	2.4 2.5 2.9 3.0 3.0
 Abbildung zeigt rechte WSP.				 Abbildung zeigt linke WSP.	WBG0201V3L-F WBG020101L-F WBG020102L-F WBG020104L-F WBGTL302V3L-F WBGTL30201L-F WBGTL30202R/L-F WBGTL30204R/L-F	1.0 1.0 1.0 1.0 1.0 1.0 1.0 1.0	2.0 2.0 2.1 2.2 2.0 2.0 2.1 2.2
				 Abbildung zeigt rechte WSP.	WCGT020102R/L WCGT020104R/L WCGTL30202L WCGTL30204L	1.0 1.0 1.0 1.0	2.1 2.2 2.1 2.2
				 Abbildung zeigt rechte WSP.	WPGT040204R/L-FS WPGT060304R/L-FS	1.0 1.0	3.2 3.2



# TOOL NAVI

## ÜBERSICHT

Das TOOL NAVI gibt Ihnen Informationen über die geeigneten Schnittparameter für jeden Werkstückstoff durch die Wahl der optimalen Wendeschneidplatte und Sorte zusammen mit dem Werkzeughalter.

## ETIKETTENANZEIGE

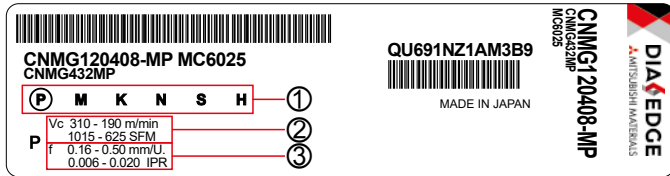

\*1 Einige WSP haben mehrere Werkstoffempfehlungen.

\*2 Wenn Sie andere als die obenstehenden Koeffizienten verwenden, setzen Sie sich bitte mit uns bzgl. der empfohlenen Schnittdaten in Verbindung.

## ② Schnittgeschwindigkeitsnormen (Leistung gegen Standzeit)

Material	Standzeit		Material	Härte
	Standzeit	Leistung		
<b>P</b>	90min	15min	C-Stahl, Leg. Stahl	180HB
<b>M</b>	90min	15min	Rostfreier Stahl	180HB
<b>K</b>	90min	15min	Guss	180HB
<b>S</b>	25min	5min	Titanlegierung	320HB
			NiCo-Basislegierung	400HB
<b>H</b>	80min	10min	Gehärteter Stahl	60HRC

\*3 N : Die Schnittgeschwindigkeit wird unter Berücksichtigung der Verschleißfestigkeit der Sorte ermittelt. Wählen Sie eine höhere Schnittgeschwindigkeit bei stabilen Anwendungen und reduzieren Sie die Schnittgeschwindigkeit bei instabilen Anwendungen.

\*4 Die Standzeiten werden entsprechend der untenstehenden Werte ermittelt:

PMKS ... VB=0.3mm  
H 181 ... VB=0.1mm

## STANDZEIT

Die Schnittgeschwindigkeit hat einen großen Einfluss auf die Standzeit. Mitsubishi's TOOL NAVI errechnet die Schnittgeschwindigkeit für Standzeiten zwischen 15 und 90 Minuten auf der Basis der Taylor-Gleichung (Korrelation von Werkzeug, Zerspanungsbedingungen und Standzeit). Wenn eine andere Sorte benötigt wird, entnehmen Sie die Werte für die Koeffizienten den folgenden Tabellen. Multiplizieren Sie die Koeffizient-Werte mit der Schnittgeschwindigkeit, um die neue Schnittgeschwindigkeit zu berechnen.

### ● P Sorten (Stahl) Koeffizient Werte

Sorte	Standzeit	15min	30min	45min	60min	90min
<b>UE6105</b>		1.00	0.79	0.69	0.63	0.55
<b>MC6015</b>		1.00	0.82	0.72	0.67	0.59
<b>MC6115</b>		1.00	0.83	0.75	0.69	0.62
<b>MC6025</b>		1.00	0.83	0.75	0.69	0.62
<b>MC6125</b>		1.00	0.83	0.75	0.69	0.62
<b>MC6035</b>		1.00	0.88	0.82	0.78	0.73
<b>MP3025</b>		1.00	0.85	0.77	0.72	0.65
<b>NX2525</b>		1.00	0.87	0.80	0.76	0.70

### ● M Sorten (rostfreier Stahl) Koeffizient Werte

Sorte	Standzeit	15min	30min	45min	60min	90min
<b>MC7015</b>		1.00	0.83	0.75	0.70	0.63
<b>MC7025</b>		1.00	0.90	0.84	0.80	0.75
<b>MP7035</b>		1.00	0.84	0.76	0.71	0.62
<b>US735</b>		1.00	0.78	0.68	0.61	0.53

## HÄRTE DES WERKSTÜCKS

Die Härte des Werkstücks hat großen Einfluss auf die Standzeit. Das TOOL NAVI zeigt die Schnittgeschwindigkeit bei unterschiedlicher Werkstückhärte an, um den geeigneten Koeffizient-Wert für das jeweilige Werkstück zu erhalten. Multiplizieren Sie die Koeffizienten Werte mit der Schnittgeschwindigkeit, um die neue Schnittgeschwindigkeit zu berechnen.

Material	(Härte des Werkstücks)											
	120HB	140HB	160HB	180HB	200HB	220HB	240HB	260HB	280HB	300HB	320HB	340HB
<b>P</b>	1.34	1.19	1.08	1.00	0.92	0.85	0.80	0.75	0.71	0.68	0.64	0.61
<b>M</b>	1.41	1.23	1.10	1.00	0.91	0.85	0.78	0.72	0.68	0.64	0.61	0.58
<b>K</b>	1.27	1.19	1.09	1.00	0.97	0.91	0.88	0.85	0.81	0.78	0.75	0.72

## ① Werkstoff

- P** : Stahl (Materialreferenz : C-Stahl, Leg. Stahl 180HB)
- M** : Rostfreier Stahl (Materialreferenz : Austenitisch rostfreier Stahl 180HB)
- K** : Guss (Materialreferenz : Grauguss, Duktiler Guss 180HB)
- N** : Aluminiumlegierung, Nichteisemetalle
- S** : Materialreferenz : Titanlegierung 320HB, NiCo-Basislegierung. 400HB
- H** : Gehärteter Stahl 60HRC

## ③ Vorschubgeschwindigkeit

Die angezeigte minimale und maximale Vorschubgeschwindigkeit basiert auf dem Spankontrollbereich und ist abhängig von der Geometrie des Spanbrechers.

### ● K Sorten (Guss) Koeffizient Werte

Sorte	Standzeit	15min	30min	45min	60min	90min
<b>MC5005</b>		1.00	0.83	0.75	0.70	0.63
<b>MC5015</b>		1.00	0.83	0.75	0.69	0.62

(Beispiel) Mittlere Zerspanung von Stahl  
1. Empfehlung : MC6025  
Wendeschneidplatten : CNMG120408-MP  
Schnittgeschwindigkeit : Vc=310m/min  
(Standzeit : 15 Min.)



Vom Kunden benötigte Standzeit : 30 Min.

$$310 \times 0.83 \approx 257 \text{ m/min}$$

A

WSP DREHEN

# OPTIMALE SORTEN UND SPANBRECHER FÜR EXTERNES DREHEN

● **Auswahl der optimalen Dreh-Wendeschneidplatte**

Die folgenden Diagramme zeigen für jeden Werkstoff die optimale Kombination von geeigneten Sorten und Spanbrechern für den jeweiligen Anwendungsbereich Drehen.

WSP DREHEN

■ **SCHNITTBEDINGUNGEN**

- **Stabile Bearbeitung**  
Kontinuierlicher Schnitt  
Konstante Schnitttiefe  
Vorbearbeitet  
Sichere und stabile Aufspannung und Schnittbedingungen
- **Allgemeine Bearbeitung**
- ⊕ **Instabile Bearbeitung**  
Schwerzerspannung, unterbr. Schnitt  
Wechselnde Schnitttiefen  
Instabile Spann- und Schnittverhältnisse

■ **ANWENDUNGSBEREICH**

- F** Schlichtzerspanung
- L** Leichtzerspanung
- M** Mittlere Zerspanung
- R** Schruppzerspanung
- H** Schwerzerspanung

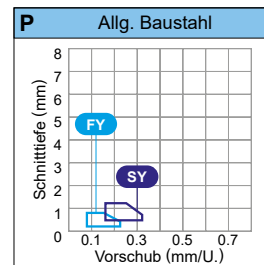
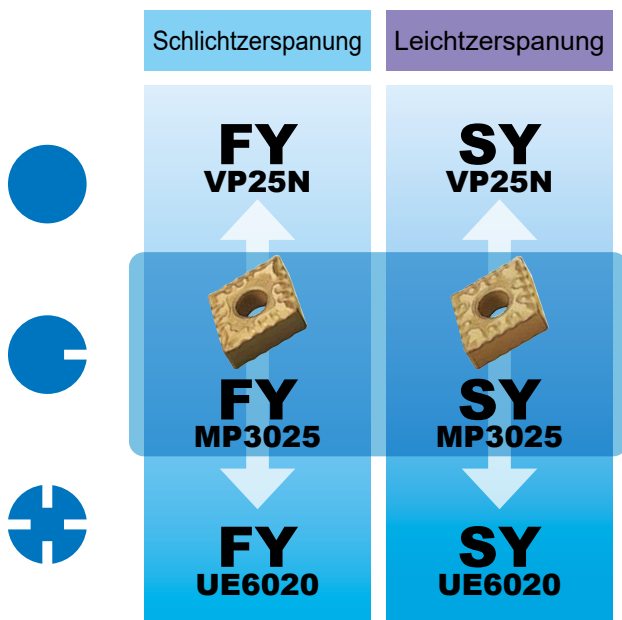

**P** Allg. Baustahl\* (Beispiel St37-2, Ck10)  
NEGATIVE WENDESCHNEIDPLATTEN

Vc : Schnittgeschw.  
f : Vorschub  
ap : Schnitttiefe

	Anwendungsbereich	Spanbrecher	Sorte	1. Empfehlung		
				Vc (m/min)	f (mm/U.)	ap (mm)
● Stabile Bearbeitung	<b>F</b>	<b>FY</b>	<b>VP25N</b>	285–450	0.09–0.23	0.20–0.80
	<b>L</b>	<b>SY</b>	<b>VP25N</b>	260–410	0.16–0.33	0.50–1.20
● Allgemeine Bearbeitung	<b>F</b>	<b>FY</b>	<b>MP3025</b>	275–425	0.09–0.23	0.20–0.80
	<b>L</b>	<b>SY</b>	<b>MP3025</b>	255–385	0.16–0.33	0.50–1.20
⊕ Instabile Bearbeitung	<b>F</b>	<b>FY</b>	<b>UE6020</b>	285–465	0.09–0.23	0.20–0.80
	<b>L</b>	<b>SY</b>	<b>UE6020</b>	260–425	0.16–0.33	0.50–1.20

\*Siehe Seite A074 für anderen Stahl.

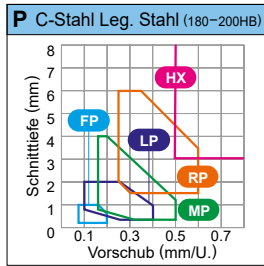

- Stabile Bearbeitung
- ◐ Allgemeine Bearbeitung
- ⊕ Instabile Bearbeitung

- F** Schlichtzerspanung
- L** Leichtzerspanung
- M** Mittlere Zerspanung
- R** Schruppzerspanung
- H** Schwerzerspanung

A  
WSP DREHEN



**P** C-Stahl • Leg. Stahl\* (Beispiel Ck45, 42CrMo4)  
NEGATIVE WENDESCHNEIDPLATTEN

Vc : Schnittgeschw.  
f : Vorschub  
ap : Schnitttiefe

	Anwendungsbereich	Spanbrecher	Sorte	1. Empfehlung		
				Vc (m/min)	f (mm/U.)	ap (mm)
● Stabile Bearbeitung	<b>F</b>	<b>FP</b>	<b>NX2525</b>	210–300	0.08–0.25	0.10–1.00
	<b>L</b>	<b>LP</b>	<b>MC6115</b>	250–480	0.10–0.40	0.30–2.00
	<b>M</b>	<b>MP</b>	<b>MC6115</b>	230–440	0.16–0.50	0.30–4.00
	<b>R</b>	<b>RP</b>	<b>MC6115</b>	215–415	0.25–0.60	1.50–6.00
	<b>H</b>	<b>HX</b>	<b>MC6025</b>	165–265	0.50–1.26	3.00–11.00
◐ Allgemeine Bearbeitung	<b>F</b>	<b>FP</b>	<b>MP3025</b>	215–330	0.08–0.25	0.10–1.00
	<b>L</b>	<b>LP</b>	<b>MC6115</b>	250–480	0.10–0.40	0.30–2.00
	<b>M</b>	<b>MP</b>	<b>MC6125</b>	250–390	0.16–0.50	0.30–4.00
	<b>R</b>	<b>RP</b>	<b>MC6125</b>	235–370	0.25–0.60	1.50–6.00
	<b>H</b>	<b>HX</b>	<b>MC6025</b>	165–265	0.50–1.26	3.00–11.00
⊕ Instabile Bearbeitung	<b>F</b>	<b>FP</b>	<b>MC6025</b>	230–375	0.08–0.25	0.10–1.00
	<b>L</b>	<b>LP</b>	<b>MC6125</b>	275–425	0.10–0.40	0.30–2.00
	<b>M</b>	<b>MP</b>	<b>MC6125</b>	250–390	0.16–0.50	0.30–4.00
	<b>R</b>	<b>RP</b>	<b>MC6125</b>	235–370	0.25–0.60	1.50–6.00
	<b>H</b>	<b>HX</b>	<b>MC6035</b>	140–200	0.50–1.26	3.00–11.00

\*Siehe Seite A074 für anderen Stahl.

# OPTIMALE SORTEN UND SPANBRECHER FÜR EXTERNES DREHEN

WSP DREHEN

A

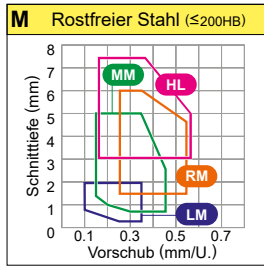

- Stabile Bearbeitung
- Allgemeine Bearbeitung
- Instabile Bearbeitung

- L** Leichtzerspanung
- M** Mittlere Zerspanung
- R** Schrappzerspanung
- H** Schwerzerspanung

	Leichtzerspanung	Mittlere Zerspanung	Schrappzerspanung	Schwerzerspanung
	<b>LM</b> MC7015	<b>MM</b> MC7015	<b>RM</b> MC7015	<b>HL</b> US735
	<b>LM</b> MC7025	<b>MM</b> MC7025	<b>RM</b> MC7025	<b>HL</b> US735
	<b>LM</b> MP7035	<b>MM</b> MP7035	<b>RM</b> MP7035	<b>HL</b> US735

## M Rostfreier Stahl\* (Beispiel X5CrNi189, X5CrNiMo1810)

NEGATIVE WENDESCHNEIDPLATTEN

Vc : Schnittgeschw.  
f : Vorschub  
ap : Schnitttiefe

	Anwendungsbereich	Spanbrecher	Sorte	1. Empfehlung		
				Vc (m/min)	f (mm/U.)	ap (mm)
	<b>L</b>	<b>LM</b>	<b>MC7015</b>	180–285	0.10–0.30	0.30–2.00
	<b>M</b>	<b>MM</b>	<b>MC7015</b>	165–260	0.15–0.45	0.70–5.00
	<b>R</b>	<b>RM</b>	<b>MC7015</b>	155–245	0.25–0.55	1.50–6.00
	<b>H</b>	<b>HL</b>	<b>US735</b>	75–140	0.40–1.00	1.50–8.00
	<b>L</b>	<b>LM</b>	<b>MC7025</b>	165–220	0.10–0.30	0.30–2.00
	<b>M</b>	<b>MM</b>	<b>MC7025</b>	150–200	0.15–0.45	0.70–5.00
	<b>R</b>	<b>RM</b>	<b>MC7025</b>	140–190	0.25–0.55	1.50–6.00
	<b>H</b>	<b>HL</b>	<b>US735</b>	75–140	0.40–1.00	1.50–8.00
	<b>L</b>	<b>LM</b>	<b>MP7035</b>	95–155	0.10–0.30	0.30–2.00
	<b>M</b>	<b>MM</b>	<b>MP7035</b>	90–145	0.15–0.45	0.70–5.00
	<b>R</b>	<b>RM</b>	<b>MP7035</b>	85–135	0.25–0.55	1.50–6.00
	<b>H</b>	<b>HL</b>	<b>US735</b>	75–140	0.40–1.00	1.50–8.00

\*Siehe Seite A078 für anderen rostfreien Stahl.

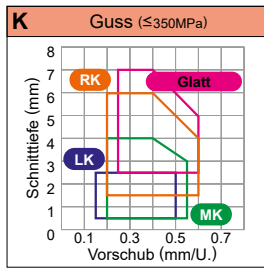

- Stabile Bearbeitung
- ◐ Allgemeine Bearbeitung
- ⊕ Instabile Bearbeitung

- L** Leichtzerspanung
- M** Mittlere Zerspanung
- R** Schruppzerspanung
- H** Schwerzerspanung

A  
WSP DREHEN



**K** Guss\* (Beispiel GG30)  
NEGATIVE WENDESCHNEIDPLATTEN

Vc : Schnittgeschw.  
f : Vorschub  
ap : Schnitttiefe

	Anwendungsbereich	Spanbrecher	Sorte	1. Empfehlung		
				Vc (m/min)	f (mm/U.)	ap (mm)
Stabile Bearbeitung	<b>L</b>	<b>LK</b>	<b>MC5005</b>	230–365	0.10–0.40	0.30–2.00
	<b>M</b>	<b>MK</b>	<b>MC5005</b>	210–335	0.20–0.55	1.00–4.00
	<b>R</b>	<b>RK</b>	<b>MC5005</b>	195–315	0.25–0.60	1.50–6.00
	<b>H</b>	<b>Glatt</b>	<b>MC5005</b>	195–315	0.20–0.60	2.50–6.00
Allgemeine Bearbeitung	<b>L</b>	<b>LK</b>	<b>MC5015</b>	205–335	0.10–0.40	0.30–2.00
	<b>M</b>	<b>MK</b>	<b>MC5015</b>	190–305	0.20–0.55	1.00–4.00
	<b>R</b>	<b>RK</b>	<b>MC5015</b>	180–285	0.25–0.60	1.50–6.00
	<b>H</b>	<b>Glatt</b>	<b>MC5015</b>	180–285	0.20–0.60	2.50–6.00
Instabile Bearbeitung	<b>L</b>	<b>LK</b>	<b>MC5015</b>	205–335	0.10–0.40	0.30–2.00
	<b>M</b>	<b>MK</b>	<b>MC5015</b>	190–305	0.20–0.55	1.00–4.00
	<b>R</b>	<b>RK</b>	<b>MC5015</b>	180–285	0.25–0.60	1.50–6.00
	<b>H</b>	<b>Glatt</b>	<b>MC5015</b>	180–285	0.20–0.60	2.50–6.00

\*Siehe Seite A083 für anderes Gusseisen.

# OPTIMALE SORTEN UND SPANBRECHER FÜR EXTERNES DREHEN

WSP DREHEN

A

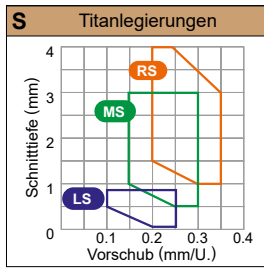

- Stabile Bearbeitung
- ◐ Allgemeine Bearbeitung
- ⊕ Instabile Bearbeitung

- F** Schlichtzerspanung
- L** Leichtzerspanung
- M** Mittlere Zerspanung
- R** Schruppzerspanung



**S** Titanlegierungen (Beispiel Ti-6Al-4V)  
NEGATIVE WENDESCHNEIDPLATTEN

V<sub>c</sub> : Schnittgeschw.  
f : Vorschub  
a<sub>p</sub> : Schnitttiefe

	Anwendungsbereich	Spanbrecher	Sorte	1. Empfehlung		
				V <sub>c</sub> (m/min)	f (mm/U.)	a <sub>p</sub> (mm)
● Stabile Bearbeitung	<b>F</b>	<b>LS</b>	<b>MT9015</b>	40–85	0.10–0.25	0.20–0.80
	<b>L</b>	<b>LS</b>	<b>MT9015</b>	40–85	0.10–0.25	0.20–0.80
	<b>M</b>	<b>MS</b>	<b>MT9015</b>	40–80	0.15–0.30	0.50–3.00
	<b>R</b>	<b>RS</b>	<b>MT9015</b>	35–75	0.20–0.35	1.00–4.00
◐ Allgemeine Bearbeitung	<b>F</b>	<b>LS</b>	<b>MT9015</b>	40–85	0.10–0.25	0.20–0.80
	<b>L</b>	<b>LS</b>	<b>MT9015</b>	40–85	0.10–0.25	0.20–0.80
	<b>M</b>	<b>MS</b>	<b>MT9015</b>	40–80	0.15–0.30	0.50–3.00
	<b>R</b>	<b>RS</b>	<b>MT9015</b>	35–75	0.20–0.35	1.00–4.00
⊕ Instabile Bearbeitung	<b>F</b>	<b>LS</b>	<b>MT9015</b>	40–85	0.10–0.25	0.20–0.80
	<b>L</b>	<b>LS</b>	<b>MT9015</b>	40–85	0.10–0.25	0.20–0.80
	<b>M</b>	<b>MS</b>	<b>MT9015</b>	40–80	0.15–0.30	0.50–3.00
	<b>R</b>	<b>RS</b>	<b>MT9015</b>	35–75	0.20–0.35	1.00–4.00



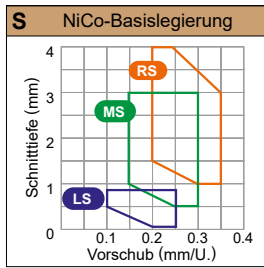

- Stabile Bearbeitung
- ◐ Allgemeine Bearbeitung
- ⊕ Instabile Bearbeitung

- F** Schlichtzerspanung
- L** Leichtzerspanung
- M** Mittlere Zerspanung
- R** Schruppzerspanung

A  
WSP DREHEN



**S** NiCo-Basislegierung (Beispiel Inconel®718)  
NEGATIVE WENDESCHNEIDPLATTEN

Vc : Schnittgeschw.  
f : Vorschub  
ap : Schnitttiefe

	Anwendungsbereich	Spanbrecher	Sorte	1. Empfehlung		
				Vc (m/min)	f (mm/U.)	ap (mm)
● Stabile Bearbeitung	<b>F</b>	<b>LS</b>	<b>MP9005</b>	30–110	0.10–0.25	0.20–0.80
	<b>L</b>	<b>LS</b>	<b>MP9005</b>	30–110	0.10–0.25	0.20–0.80
	<b>M</b>	<b>MS</b>	<b>MP9005</b>	30–100	0.15–0.30	0.50–3.00
	<b>R</b>	<b>RS</b>	<b>MP9015</b>	20–75	0.20–0.35	1.00–4.00
◐ Allgemeine Bearbeitung	<b>F</b>	<b>LS</b>	<b>MP9015</b>	25–85	0.10–0.25	0.20–0.80
	<b>L</b>	<b>LS</b>	<b>MP9015</b>	25–85	0.10–0.25	0.20–0.80
	<b>M</b>	<b>MS</b>	<b>MP9015</b>	25–80	0.15–0.30	0.50–3.00
	<b>R</b>	<b>RS</b>	<b>MP9015</b>	20–75	0.20–0.35	1.00–4.00
⊕ Instabile Bearbeitung	<b>F</b>	<b>LS</b>	<b>MP9025</b>	20–30	0.10–0.25	0.20–0.80
	<b>L</b>	<b>LS</b>	<b>MP9025</b>	20–30	0.10–0.25	0.20–0.80
	<b>M</b>	<b>MS</b>	<b>MP9025</b>	20–30	0.15–0.30	0.50–3.00
	<b>R</b>	<b>RS</b>	<b>MP9025</b>	15–25	0.20–0.35	1.00–4.00

# OPTIMALE SORTEN UND SPANBRECHER FÜR EXTERNES DREHEN

A

WSP DREHEN



- Stabile Bearbeitung
- Allgemeine Bearbeitung
- ⊕ Instabile Bearbeitung
- F** Schlichtzerspanung
- L** Leichtzerspanung
- M** Mittlere Zerspanung

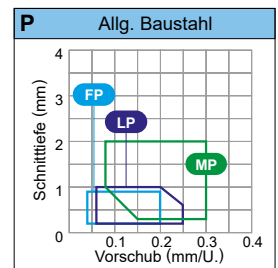

**P** Allg. Baustahl\* (Beispiel St37-2, Ck10)  
7° POSITIVE WENDESCHNEIDPLATTEN MIT LOCH

Vc : Schnittgeschw.  
f : Vorschub  
ap : Schnitttiefe

	Anwendungsbereich	Spanbrecher	Sorte	1. Empfehlung		
				Vc (m/min)	f (mm/U.)	ap (mm)
Stabile Bearbeitung	<b>F</b>	<b>FP</b>	<b>NX2525</b>	225–320	0.04–0.20	0.20–0.90
	<b>L</b>	<b>LP</b>	<b>NX2525</b>	225–320	0.06–0.25	0.20–1.00
	<b>M</b>	<b>MP</b>	<b>NX2525</b>	185–270	0.08–0.30	0.30–2.00
Allgemeine Bearbeitung	<b>F</b>	<b>FP</b>	<b>MC6015</b>	250–425	0.04–0.20	0.20–0.90
	<b>L</b>	<b>LP</b>	<b>MC6015</b>	250–425	0.06–0.25	0.20–1.00
	<b>M</b>	<b>MP</b>	<b>MC6015</b>	210–355	0.08–0.30	0.30–2.00
Instabile Bearbeitung	<b>F</b>	<b>FP</b>	<b>MC6025</b>	250–405	0.04–0.20	0.20–0.90
	<b>L</b>	<b>LP</b>	<b>MC6025</b>	250–405	0.06–0.25	0.20–1.00
	<b>M</b>	<b>MP</b>	<b>MC6025</b>	210–340	0.08–0.30	0.30–2.00

\*Siehe Seite A087 für anderen Stahl.



- Stabile Bearbeitung
- Allgemeine Bearbeitung
- ⊕ Instabile Bearbeitung
- F** Schlichtzerspanung
- L** Leichtzerspanung
- M** Mittlere Zerspanung

**A**  
WSP DREHEN

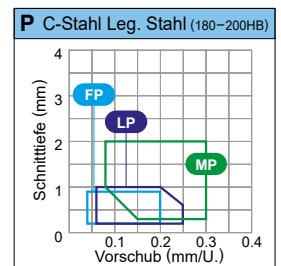

## **P** C-Stahl • Leg. Stahl\* (Beispiel Ck45, 42CrMo4) 7° POSITIVE WENDESCHNEIDPLATTEN MIT LOCH

**V<sub>c</sub>** : Schnittgeschw.  
**f** : Vorschub  
**ap** : Schnitttiefe

	Anwendungsbereich	Spanbrecher	Sorte	1. Empfehlung		
				V <sub>c</sub> (m/min)	f (mm/U.)	ap (mm)
Stabile Bearbeitung	<b>F</b>	<b>FP</b>	<b>NX2525</b>	165–240	0.04–0.20	0.20–0.90
	<b>L</b>	<b>LP</b>	<b>NX2525</b>	165–240	0.06–0.25	0.20–1.00
	<b>M</b>	<b>MP</b>	<b>NX2525</b>	140–200	0.08–0.30	0.30–2.00
Allgemeine Bearbeitung	<b>F</b>	<b>FP</b>	<b>MC6015</b>	185–315	0.04–0.20	0.20–0.90
	<b>L</b>	<b>LP</b>	<b>MC6015</b>	185–315	0.06–0.25	0.20–1.00
	<b>M</b>	<b>MP</b>	<b>MC6015</b>	155–260	0.08–0.30	0.30–2.00
Instabile Bearbeitung	<b>F</b>	<b>FP</b>	<b>MC6025</b>	185–300	0.04–0.20	0.20–0.90
	<b>L</b>	<b>LP</b>	<b>MC6025</b>	185–300	0.06–0.25	0.20–1.00
	<b>M</b>	<b>MP</b>	<b>MC6025</b>	155–250	0.08–0.30	0.30–2.00

\*Siehe Seite A087 für anderen Stahl.

# OPTIMALE SORTEN UND SPANBRECHER FÜR EXTERNES DREHEN

WSP DREHEN



- Stabile Bearbeitung
- Allgemeine Bearbeitung
- Instabile Bearbeitung
- F** Schlichtzerspanung
- L** Leichtzerspanung
- M** Mittlere Zerspanung

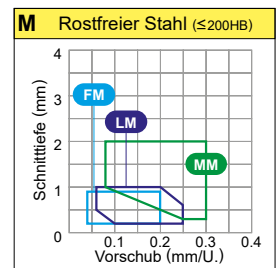

## M Rostfreier Stahl\* (Beispiel X5CrNi189, X5CrNiMo1810)

7° POSITIVE WENDESCHNEIDPLATTEN MIT LOCH

Vc : Schnittgeschw.  
f : Vorschub  
ap : Schnitttiefe

	Anwendungsbereich	1. Empfehlung				
		Spanbrecher	Sorte	Vc (m/min)	f (mm/U.)	ap (mm)
Stabile Bearbeitung	<b>F</b>	<b>FM</b>	<b>VP15TF</b>	75–125	0.04–0.20	0.20–0.90
	<b>L</b>	<b>LM</b>	<b>MC7025</b>	140–190	0.06–0.25	0.20–1.00
	<b>M</b>	<b>MM</b>	<b>MC7025</b>	120–160	0.08–0.30	0.30–2.00
Allgemeine Bearbeitung	<b>F</b>	<b>FM</b>	<b>VP15TF</b>	75–125	0.04–0.20	0.20–0.90
	<b>L</b>	<b>LM</b>	<b>MC7025</b>	140–190	0.06–0.25	0.20–1.00
	<b>M</b>	<b>MM</b>	<b>MC7025</b>	120–160	0.08–0.30	0.30–2.00
Instabile Bearbeitung	<b>F</b>	<b>FM</b>	<b>VP15TF</b>	75–125	0.04–0.20	0.20–0.90
	<b>L</b>	<b>LM</b>	<b>MP7035</b>	85–135	0.06–0.25	0.20–1.00
	<b>M</b>	<b>MM</b>	<b>MP7035</b>	70–115	0.08–0.30	0.30–2.00

\*Siehe Seite A089 für anderen rostfreien Stahl.



- Stabile Bearbeitung
- Allgemeine Bearbeitung
- ⊕ Instabile Bearbeitung
- F** Schlichtzerspanung
- L** Leichtzerspanung
- M** Mittlere Zerspanung

**A**  
WSP DREHEN

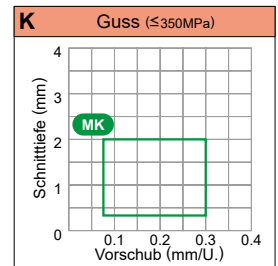

**K** Guss\* (Beispiel GG30)  
7° POSITIVE WENDESCHNEIDPLATTEN MIT LOCH

Vc : Schnittgeschw.  
f : Vorschub  
ap : Schnitttiefe

	Anwendungsbereich	1. Empfehlung				
		Spanbrecher	Sorte	Vc (m/min)	f (mm/U.)	ap (mm)
● Stabile Bearbeitung	<b>F</b>	<b>MK</b>	<b>MC5005</b>	165–265	0.08–0.30	0.30–2.00
	<b>L</b>	<b>MK</b>	<b>MC5005</b>	165–265	0.08–0.30	0.30–2.00
	<b>M</b>	<b>MK, Glatt</b>	<b>MC5005</b>	165–265	0.08–0.30	0.30–2.00
● Allgemeine Bearbeitung	<b>F</b>	<b>MK</b>	<b>MC5015</b>	150–240	0.08–0.30	0.30–2.00
	<b>L</b>	<b>MK</b>	<b>MC5015</b>	150–240	0.08–0.30	0.30–2.00
	<b>M</b>	<b>MK, Glatt</b>	<b>MC5015</b>	150–240	0.08–0.30	0.30–2.00
⊕ Instabile Bearbeitung	<b>F</b>	<b>MK</b>	<b>MC5015</b>	150–240	0.08–0.30	0.30–2.00
	<b>L</b>	<b>MK</b>	<b>MC5015</b>	150–240	0.08–0.30	0.30–2.00
	<b>M</b>	<b>MK, Glatt</b>	<b>MC5015</b>	150–240	0.08–0.30	0.30–2.00

\*Siehe Seite A092 für anderes Gusseisen.

# OPTIMALE SORTEN UND SPANBRECHER FÜR EXTERNES DREHEN

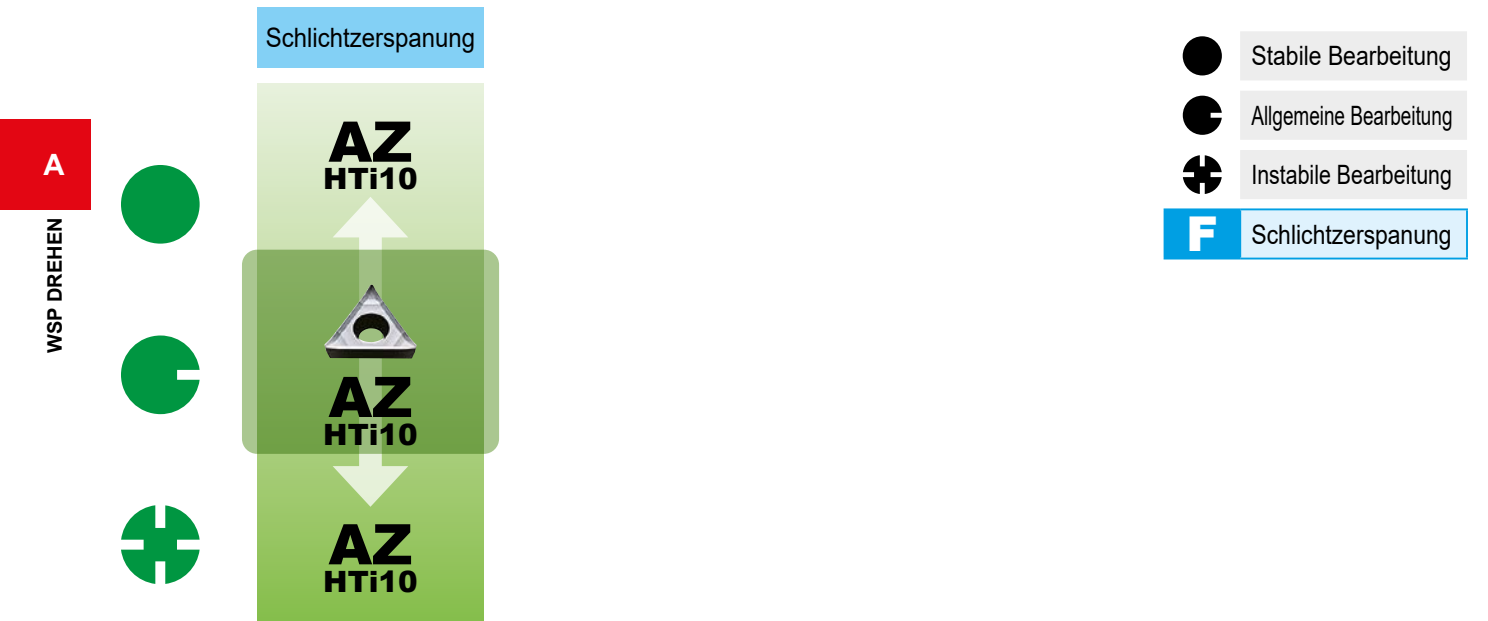

**N** Aluminiumlegierung\* (Beispiel A6061, A7075)  
7° POSITIVE WENDESCHNEIDPLATTEN MIT LOCH

Vc : Schnittgeschw.  
f : Vorschub  
ap : Schnitttiefe

	Anwendungsbereich	Spanbrecher	Sorte	1. Empfehlung		
				Vc (m/min)	f (mm/U.)	ap (mm)
● Stabile Bearbeitung	<b>F</b>	<b>AZ</b>	<b>HTi10</b>	300–700	0.10–0.40	0.20–3.00
● Allgemeine Bearbeitung	<b>F</b>	<b>AZ</b>	<b>HTi10</b>	300–700	0.10–0.40	0.20–3.00
⊕ Instabile Bearbeitung	<b>F</b>	<b>AZ</b>	<b>HTi10</b>	300–700	0.10–0.40	0.20–3.00

\*Siehe Seite A093 für andere Aluminiumlegierungen.





- Stabile Bearbeitung
- ◐ Allgemeine Bearbeitung
- ⊕ Instabile Bearbeitung
- F** Schlichtzerspanung
- L** Leichtzerspanung
- M** Mittlere Zerspanung

A  
WSP DREHEN

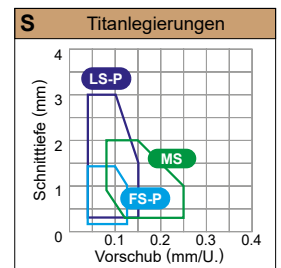

## S Titanlegierungen (Beispiel Ti-6Al-4V)

### 7° POSITIVE WENDESCHNEIDPLATTEN MIT LOCH

Vc : Schnittgeschw.  
f : Vorschub  
ap : Schnitttiefe

	Anwendungsbereich	Spanbrecher	Sorte	1. Empfehlung		
				Vc (m/min)	f (mm/U.)	ap (mm)
● Stabile Bearbeitung	<b>F</b>	<b>FS-P</b>	<b>MT9005</b>	40–80	0.04–0.12	0.20–1.40
	<b>L</b>	<b>LS-P</b>	<b>MT9005</b>	40–80	0.04–0.15	0.30–3.00
	<b>M</b>	<b>MS</b>	<b>MT9005</b>	35–65	0.08–0.25	0.30–2.00
◐ Allgemeine Bearbeitung	<b>F</b>	<b>FS-P</b>	<b>MT9005</b>	40–80	0.04–0.12	0.20–1.40
	<b>L</b>	<b>LS-P</b>	<b>MT9005</b>	40–80	0.04–0.15	0.30–3.00
	<b>M</b>	<b>MS</b>	<b>MT9005</b>	35–65	0.08–0.25	0.30–2.00
⊕ Instabile Bearbeitung	<b>F</b>	<b>FS-P</b>	<b>MT9005</b>	40–80	0.04–0.12	0.20–1.40
	<b>L</b>	<b>LS-P</b>	<b>MT9005</b>	40–80	0.04–0.15	0.30–3.00
	<b>M</b>	<b>MS</b>	<b>MT9005</b>	35–65	0.08–0.25	0.30–2.00

# OPTIMALE SORTEN UND SPANBRECHER FÜR EXTERNES DREHEN

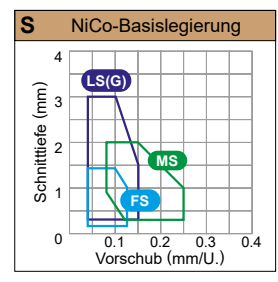
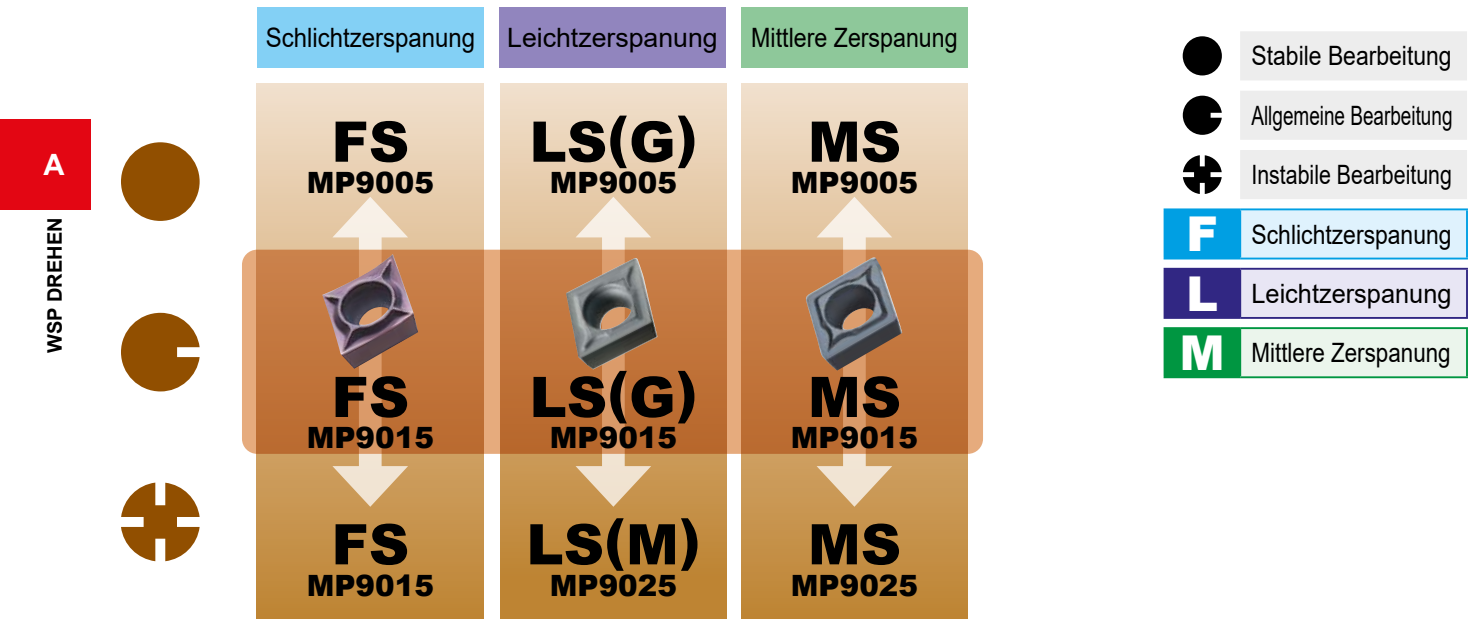

## S NiCo-Basislegierung\* (Beispiel Inconel718) 7° POSITIVE WENDESCHNEIDPLATTEN MIT LOCH

Vc : Schnittgeschw.  
f : Vorschub  
ap : Schnitttiefe

	Anwendungsbereich	1. Empfehlung				
		Spanbrecher	Sorte	Vc (m/min)	f (mm/U.)	ap (mm)
Stabile Bearbeitung	F	FS	MP9005	25–95	0.04–0.12	0.20–1.40
	L	LS(G)	MP9005	25–95	0.04–0.15	0.30–3.00
	M	MS	MP9005	20–80	0.08–0.25	0.30–2.00
Allgemeine Bearbeitung	F	FS	MP9015	20–75	0.04–0.12	0.20–1.40
	L	LS(G)	MP9015	20–75	0.04–0.15	0.30–3.00
	M	MS	MP9015	20–60	0.08–0.25	0.30–2.00
Instabile Bearbeitung	F	FS	MP9015	20–75	0.04–0.12	0.20–1.40
	L	LS(M)	MP9025	15–25	0.06–0.20	0.20–1.00
	M	MS	MP9025	15–20	0.08–0.25	0.30–2.00

\*Die G Toleranz empfiehlt sich für FS/LS Spanbrecher

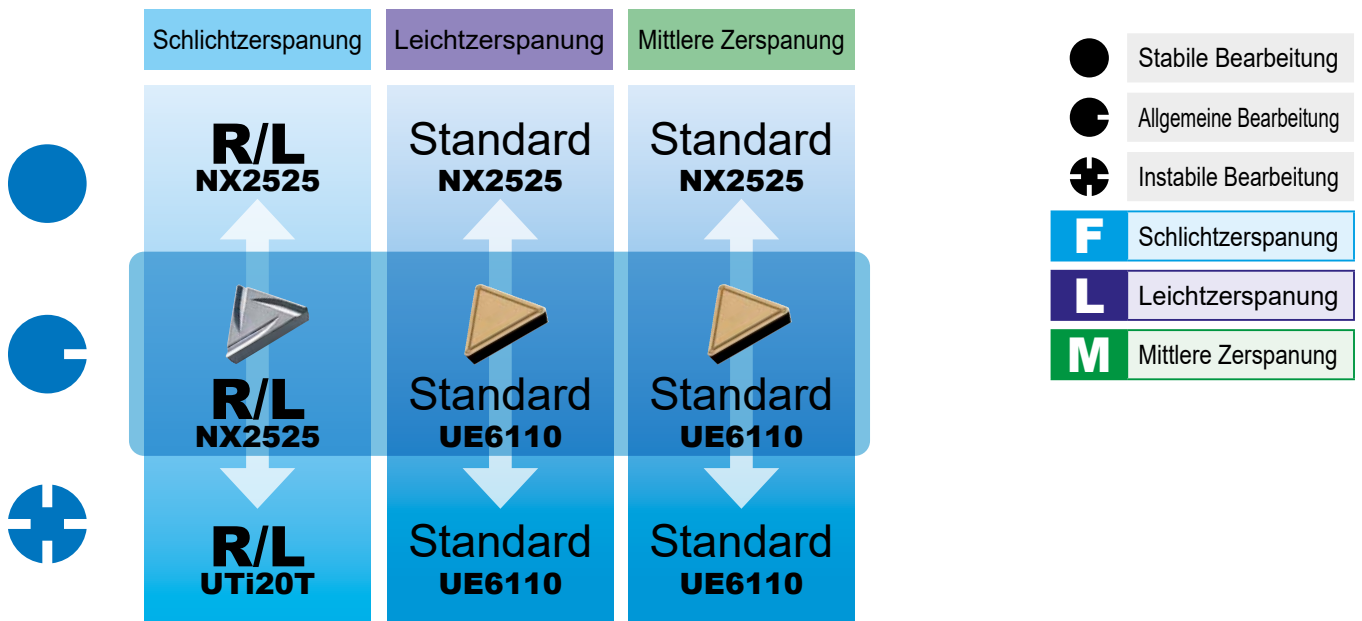

- Stabile Bearbeitung
- Allgemeine Bearbeitung
- Instabile Bearbeitung
- Schlichtzerspanung
- Leichtzerspanung
- Mittlere Zerspanung

**A**  
WSP DREHEN

**P** Allg. Baustahl (Beispiel St37-2, Ck10)  
11° POSITIVE WENDESCHNEIDPLATTEN OHNE LOCH

Vc : Schnittgeschw.  
f : Vorschub  
ap : Schnitttiefe

	Anwendungsbereich	1. Empfehlung				
		Spanbrecher	Sorte	Vc (m/min)	f (mm/U.)	ap (mm)
Stabile Bearbeitung	<b>F</b>	<b>R/L</b>	<b>NX2525</b>	225–320	0.05–0.12	0.20–0.60
	<b>L</b>	<b>Standard</b>	<b>NX2525</b>	185–270	0.08–0.30	0.30–2.00
	<b>M</b>	<b>Standard</b>	<b>NX2525</b>	185–270	0.08–0.30	0.30–2.00
Allgemeine Bearbeitung	<b>F</b>	<b>R/L</b>	<b>NX2525</b>	225–320	0.05–0.12	0.20–0.60
	<b>L</b>	<b>Standard</b>	<b>UE6110</b>	210–355	0.08–0.30	0.30–2.00
	<b>M</b>	<b>Standard</b>	<b>UE6110</b>	210–355	0.08–0.30	0.30–2.00
Instabile Bearbeitung	<b>F</b>	<b>R/L</b>	<b>UTi20T</b>	115–165	0.05–0.12	0.20–0.60
	<b>L</b>	<b>Standard</b>	<b>UE6110</b>	210–355	0.08–0.30	0.30–2.00
	<b>M</b>	<b>Standard</b>	<b>UE6110</b>	210–355	0.08–0.30	0.30–2.00

# OPTIMALE SORTEN UND SPANBRECHER FÜR EXTERNES DREHEN

WSP DREHEN



- Stabile Bearbeitung
- Allgemeine Bearbeitung
- Instabile Bearbeitung
- F** Schlichtzerspanung
- L** Leichtzerspanung
- M** Mittlere Zerspanung

**P** C-Stahl • Leg. Stahl (Beispiel Ck45, 42CrMo4)  
11° POSITIVE WENDESCHNEIDPLATTEN OHNE LOCH

Vc : Schnittgeschw.  
f : Vorschub  
ap : Schnitttiefe

	Anwendungsbereich	Spanbrecher	Sorte	1. Empfehlung		
				Vc (m/min)	f (mm/U.)	ap (mm)
Stabile Bearbeitung	<b>F</b>	<b>R/L</b>	<b>NX2525</b>	165–240	0.05–0.12	0.20–0.60
	<b>L</b>	<b>Standard</b>	<b>NX2525</b>	140–200	0.08–0.30	0.30–2.00
	<b>M</b>	<b>Standard</b>	<b>NX2525</b>	140–200	0.08–0.30	0.30–2.00
Allgemeine Bearbeitung	<b>F</b>	<b>R/L</b>	<b>NX2525</b>	165–240	0.05–0.12	0.20–0.60
	<b>L</b>	<b>Standard</b>	<b>UE6110</b>	155–260	0.08–0.30	0.30–2.00
	<b>M</b>	<b>Standard</b>	<b>UE6110</b>	155–260	0.08–0.30	0.30–2.00
Instabile Bearbeitung	<b>F</b>	<b>R/L</b>	<b>UTi20T</b>	85–120	0.05–0.12	0.20–0.60
	<b>L</b>	<b>Standard</b>	<b>UE6110</b>	155–260	0.08–0.30	0.30–2.00
	<b>M</b>	<b>Standard</b>	<b>UE6110</b>	155–260	0.08–0.30	0.30–2.00

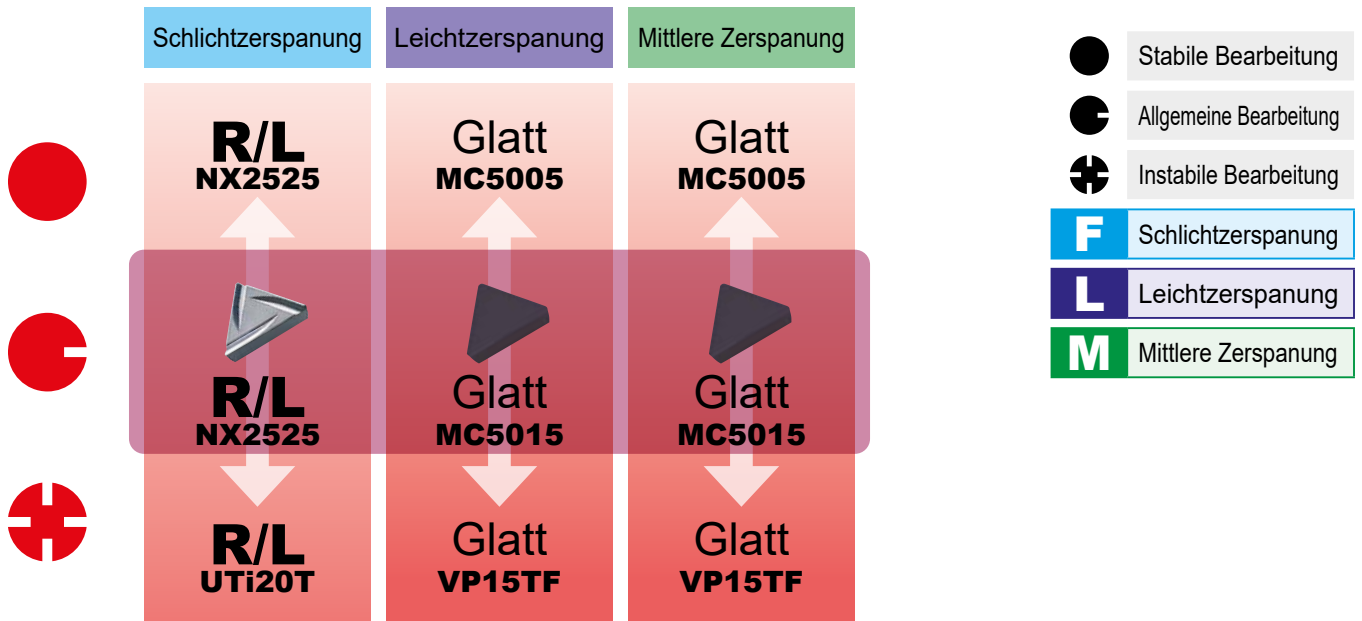

A  
WSP DREHEN

**K** Guss\* (Beispiel GG30)

11° POSITIVE WENDESCHNEIDPLATTEN OHNE LOCH

Vc : Schnittgeschw.  
f : Vorschub  
ap : Schnitttiefe

	Anwendungsbereich	Spanbrecher	Sorte	1. Empfehlung		
				Vc (m/min)	f (mm/U.)	ap (mm)
Stabile Bearbeitung	F	R/L	NX2525	145–200	0.05–0.12	0.20–0.60
	L	Glatt	MC5005	165–265	0.08–0.30	0.30–2.00
	M	Glatt	MC5005	165–265	0.08–0.30	0.30–2.00
Allgemeine Bearbeitung	F	R/L	NX2525	145–200	0.05–0.12	0.20–0.60
	L	Glatt	MC5015	150–240	0.08–0.30	0.30–2.00
	M	Glatt	MC5015	150–240	0.08–0.30	0.30–2.00
Instabile Bearbeitung	F	R/L	UTi20T	80–115	0.05–0.12	0.20–0.60
	L	Glatt	VP15TF	115–160	0.08–0.30	0.30–2.00
	M	Glatt	VP15TF	115–160	0.08–0.30	0.30–2.00

\*Siehe Seite A096 für anderes Gusseisen.

# PRÄZISIONSSPANBRECHER

EINGESCHLIFFENE UND PARALLELE SPANBRECHER (NEGATIVE WENDESCHNEIDPLATTEN)

## BEREICH DER SPANKONTROLLE

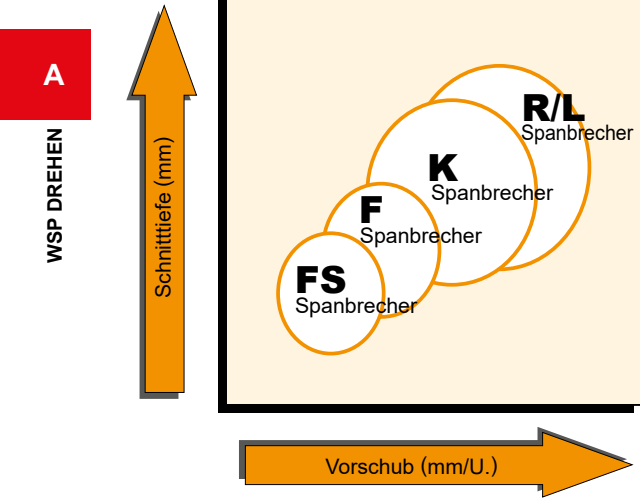

## EIGENSCHAFTEN DER SPANBRECHER

Spanbrecher	Eigenschaften	DNGG Ausführung	SNGG Ausführung	TNGG Ausführung	VNGG Ausführung
FS	<ul style="list-style-type: none"> <li>● Für Feinstschlichten.</li> <li>● Schmäler, scharfer Spanbrecher für gute Spankontrolle.</li> <li>● Scharfe Schneidkanten erzielen eine gute Oberfläche.</li> </ul>	—	—		—
F	<ul style="list-style-type: none"> <li>● Für das Schlichten.</li> <li>● Spanbrecher für die allg. Anwendung.</li> <li>● Scharfe Schneidkanten erzielen eine gute Oberfläche.</li> </ul>	—	—		—
K	<ul style="list-style-type: none"> <li>● Paralleler Spanbrecher für Feinbearbeitung.</li> <li>● Exzellente Spankontrolle bei niedrigen und mittleren Vorschüben.</li> </ul>	—	—		—
R/L	<ul style="list-style-type: none"> <li>● Paralleler Spanbrecher für die allg. Zerspanung.</li> <li>● Guter Spanbruch bei mittleren Vorschüben.</li> </ul>				

## EINGESCHLIFFENE / PARALLELE SPANBRECHER

■ Für das Drehen von kleinen Präzisionsbauteilen

■ Für allgemeines Drehen

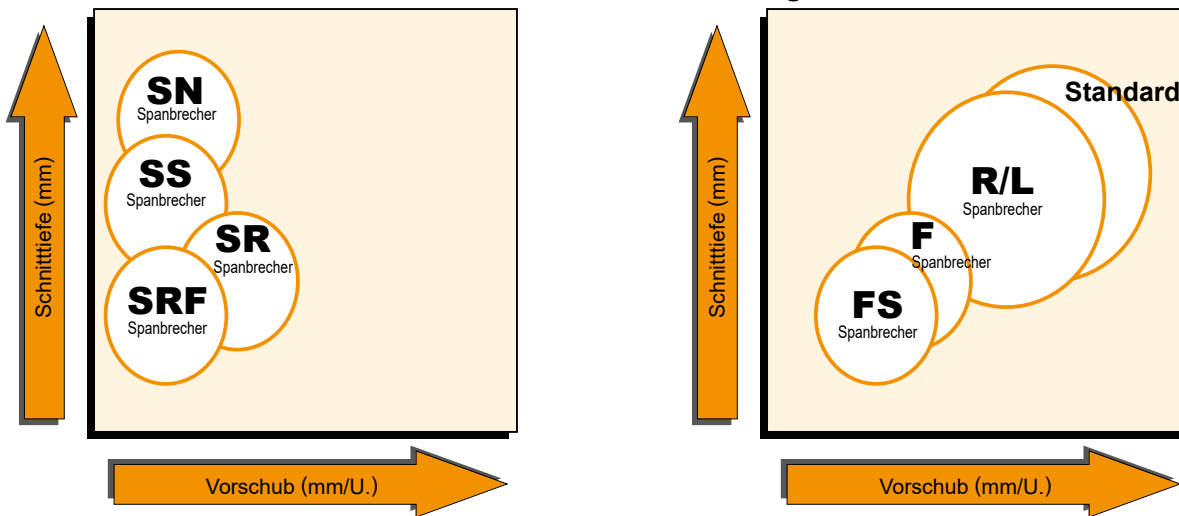

A

WSP DREHEN

## EIGENSCHAFTEN DER SPANBRECHER

Spanbrecher	Eigenschaften	CCET Ausführung	CCGT Ausführung	DCET Ausführung	DCGT Ausführung	VBET Ausführung
SRF	<ul style="list-style-type: none"> <li>Scharfer Spanbrecher für mittlere Bearbeitung ist geeignet für Drehautomaten.</li> <li>Diese Ausführung ist geeignet für gute Spankontrolle.</li> </ul>	—	—	—		
SR	<ul style="list-style-type: none"> <li>Scharfer Spanbrecher für mittlere Bearbeitung ist geeignet für Drehautomaten.</li> <li>Diese Ausführung ist geeignet für gute Spankontrolle.</li> </ul>		—		—	
SS	<ul style="list-style-type: none"> <li>Paralleler Spanbrecher für Leichtbearbeitung auf Drehautomaten.</li> <li>Exzellente Spankontrolle bei niedrigen Vorschüben.</li> </ul>	—		—		—
SN	<ul style="list-style-type: none"> <li>Paralleler Spanbrecher für Drehautomaten.</li> <li>Exzellente Spankontrolle bei niedrigen und mittleren Vorschüben.</li> </ul>					

Spanbrecher	Eigenschaften	CCGH/CCGT Ausführung	CPGT Ausführung	DCGT Ausführung	TPGH Ausführung	TCGT Ausführung	VBGT/VCGT Ausführung	WBGT Ausführung	WBGT Ausführung	WPGT Ausführung
FS	<ul style="list-style-type: none"> <li>Für das Präzisionsschlichten.</li> <li>Schmalere, scharfer Spanbrecher für gute Spankontrolle.</li> <li>Scharfe Schneidkanten erzielen eine gute Oberfläche.</li> </ul>	—	—	—		—	—	—	—	
F	<ul style="list-style-type: none"> <li>Für das Schlichten.</li> <li>Spanbrecher für die allg. Anwendung.</li> <li>Scharfe Schneidkanten erzielen eine gute Oberfläche.</li> </ul>				—				—	—
R/L	<ul style="list-style-type: none"> <li>Einsatz bei Schlichtzerspanung.</li> <li>Guter Spanbruch bei kleinen und mittleren Vorschüben.</li> </ul>	—	—	—	—	—	—	—		—
Standard	<ul style="list-style-type: none"> <li>Für leichte Zerspanung.</li> <li>Guter Spanbruch bei kleinen und mittleren Vorschüben.</li> </ul>	—		—	—	—	—	—	—	—

# WIPER WSP

## Was ist eine Wiper-Wendeschneidplatte?

- Die Wiper-Wendeschneidplatte besitzt eine Schleppe, die sich zwischen Radiusauslauf und seitlicher Schneidkante befindet.
- Im Gegensatz zu konventionellen Spanbrechern verschlechtern sich die Oberflächengüten nicht, auch wenn der Vorschub verdoppelt wird.
- Die Bearbeitung mit hohen Vorschüben steigert die Produktivität.

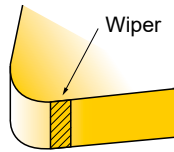

### ● Verbesserung der Oberflächengüte

Unter Beibehaltung aller Einsatzdaten, kann man die Oberflächengüte verbessern, indem man einzig und allein den Vorschub erhöht.

### ● Verbesserung der Effizienz

Hohe Vorschübe verkürzen nicht unbedingt die Bearbeitungszeit, es ist allerdings möglich, so die Schrupp- und Schlichtbearbeitung zu kombinieren.

### ● Erhöhung der Standzeit

Durch den Einsatz von hohen Vorschüben sinkt die erforderliche Bearbeitungszeit pro Teil, so dass mehr Teile mit der gleichen Wendeschneidplatte gefertigt werden können. Zusätzlich beugen die hohen Vorschübe Rattermarken vor, verzögern Verschleiß und verlängern die Standzeit der Wendeschneidplatte.

### ● Verbesserung der Spankontrolle

Beim Einsatz von hohen Vorschüben werden die Späne, die entstehen dicker und brechen leichter. Demzufolge wird die Spankontrolle verbessert.

WSP DREHEN

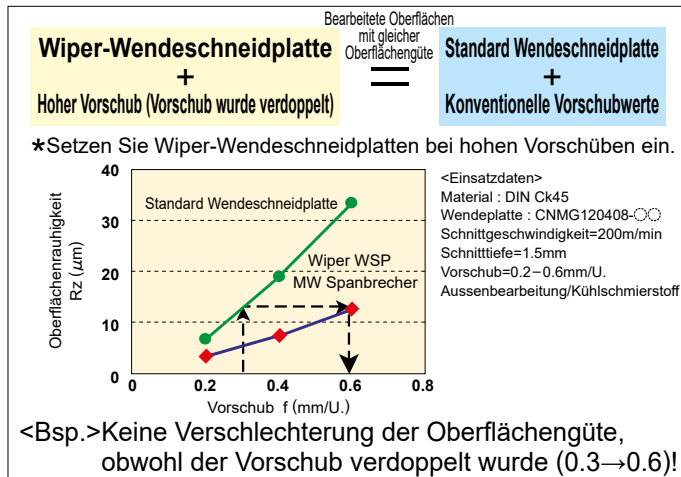

### ■ Wiper-Wendeschneidplatte + Bearbeitung mit hohen Vorschüben

- Reduzierung der Bearbeitungszeit (pro Werkstück)
- Standzeitverbesserung
- Verbesserung der Spankontrolle

### ■ Wiper-Wendeschneidplatte + Bearbeitung mit konventionellen Vorschubwerten

- Fasst Schlicht- und Schruppbearbeitung zusammen (Getrennte Schrupp- und Schlichtbearbeitung → Gesamtbearbeitung in einem Schritt)

- Kostenreduzierung
- Produktivitätssteigerung
- Vermeidet Fertigungsunterbrechungen

## Realisierung der Kostensenkung !!

## ■ Die Ermittlung der Oberflächengüte bei Einsatz einer Wiper-Wendeschneidplatte

### Der Eingriff der Wiper-Schneide bei der Aussen-, Innen- und Planbearbeitung.

\*Die Wiper-Wendeschneidplatten erzeugen die gleichen Oberflächengüten wie Standard-Wendeschneidplatten, wenn sie nur im Radius oder auf Trägerwerkzeugen mit größeren Anstellwinkeln als 5°, eingesetzt werden.

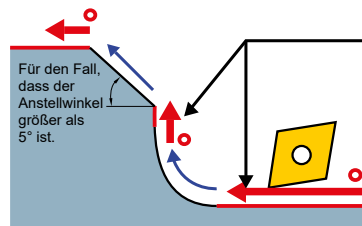

$$Rz(W) = Rz \times 0.5$$

$Rz(W)$  = Erreichbare Oberflächengüte bei Einsatz einer Wiper-Wendeschneidplatte.  
 $Rz$  : Erreichbare Oberflächengüte bei Standardeinsatzwerten. (Einsatz von Standard-Wendeschneidplatten)

— Effektiver Eingriff der Wiper-Schneide  
 — Wiper-Schneide greift nicht effektiv ein

## ■ Beim Einsatz von CNMG • WNMG • CCMT Wendeschneidplatten muss auf keine Besonderheiten geachtet werden

### ● Keine Einschränkungen der Halter

Der Standardhalter kann problemlos benutzt werden.  
 (\*Ein Doppelklemmhalter wird empfohlen.)

Keine Beschränkungen

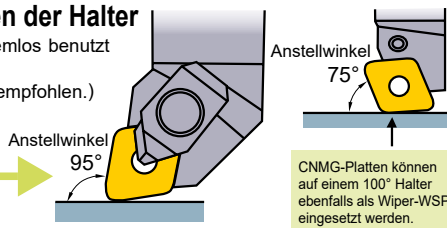

### ● Eine besondere Anpassung der Maschinenprogramme ist nicht notwendig

Die Standard-Maschinenprogramme können wie gehabt eingesetzt werden. (Die CNMG • WNMG • CCMT-Typen basieren auf ISO/ANSI Standardabmessungen.)

Eine Anpassung ist nicht notwendig

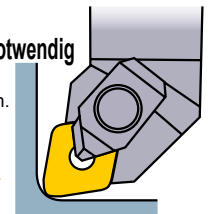

## ■ Bei dem Einsatz von DNMX • TNMX Wendeschneidplatten muss die spezielle Geometrie der Wendeplatten beachtet werden

### ● Einschränkungen der Halter

Um die Wiper-Wendeschneidplatte effizient einzusetzen, benutzen Sie bitte einen Halter mit Anstellwinkel 93°. Ein Halter mit einem Anstellwinkel von 91° kann gegebenenfalls die Effizienz der Wiperplatte verbessern (wie in dem Diagramm zu sehen), bei anderen Anstellwinkeln (60°, 90°, 107° usw.) kommt die Wiperschneide nicht zum tragen.

Die Bohrung der DNMX und TNMX Wendeplatte ist identisch mit der Bohrung der DNMG und TNMG Wendeplatten. Das "X" bezeichnet die spezielle Geometrie der Schneide.

93° (Spezifiziert)

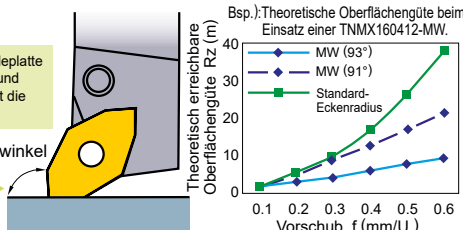

### ● Eine besondere Anpassung der Maschinenprogramme ist notwendig

Wenn ein Bearbeitungsfehler auftritt, passen Sie bitte die Maschinenprogramme an.

(Die DNMX • TNMX Wendeschneidplatten basieren nicht auf ISO/ANSI Abmessungen. Bitte schauen Sie auf die nächste Seite.)

Eine Anpassung ist notwendig

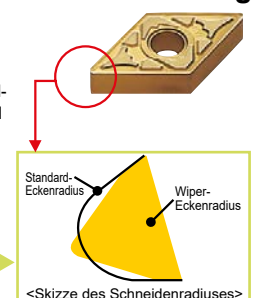



# ■ Programmieranpassung für DNMX und TNMX WSP

### Standard Prozess Anpassung der X- und Z-Achse

Anpassung der Koordinaten an Z- und X-Achse bei Einsatz einer Wiper WSP.

**Anpassung in Richtung X-Achse**

Eckenradius 0.4/0.8 : **0.04 mm**  
Eckenradius 1.2 : **0.05 mm**

### Anpassung in Richtung Z-Achse

Standard WSP

(Unabhängig vom Eckenradius) **0.01mm**

**A**  
WSP DREHEN

## A) Schneidenradiuskompensation

Führen Sie die Radiuskompensation durch. Dies ist die Voraussetzung, um eine korrekte und präzise Bearbeitung durchzuführen.

Hinweis: Die Schneidenradiuskompensation muss durchgeführt werden, wenn die Kontur nicht komplett bearbeitet wurde.

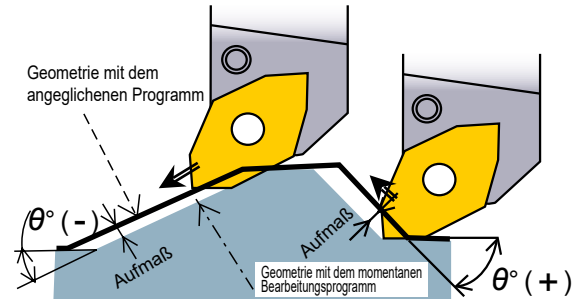

## Klassifikation

Eckenradius	Winkel															
	-25--15	-10	-5	0	5	10	15	20-35	40	45	50	55	60-65	70	75-85	90
1.2	0.04	0.03	0.01	0	0.02	0.03	0.04	0.05	0.04	0.04	0.02	0.01	-0.01	0	0.01	0
0.8	0.03	0.02	0.01	0	0.01	0.02	0.03	0.04	0.03	0.03	0.02	0	-0.01	0	0.01	0
0.4	0.02	0.01	0.01	0	0.01	0.01	0.02	0.02	0.02	0.01	0.01	0	-0.01	-0.01	0	0

Hinweis → +Werte : Anpassung des Austrittswinkels, -Werte : Anpassung des Eintauchwinkels (mm)

## B) Anpassung des Bearbeitungsradius R \*Dies ist die Voraussetzung, um den Basisprozess zu starten.

Passen Sie den Bearbeitungsdurchmesser der Verjüngung an, damit Aufmaß vermieden wird.

**Wert des angepassten Bearbeitungsradius R = Bearbeitungsradius R + Anzahl der Anpassungen**  
\*Keine Schneidenradiuskompensation notwendig.

Bsp. : Bearbeitung einer Kontur mit Eckenradius 2.0mm und einer WSP mit Eckenradius 1.2mm.

Der Eckenradius der WSP	Angeglichener Wert für den zu bearbeitenden Radius
Eckenradius 0.4 →	Zu bearbeitender Radius <b>+0.05(mm)</b>
Eckenradius 0.8 →	Zu bearbeitender Radius <b>+0.11(mm)</b>
Eckenradius 1.2 →	Zu bearbeitender Radius <b>+0.14(mm)</b>

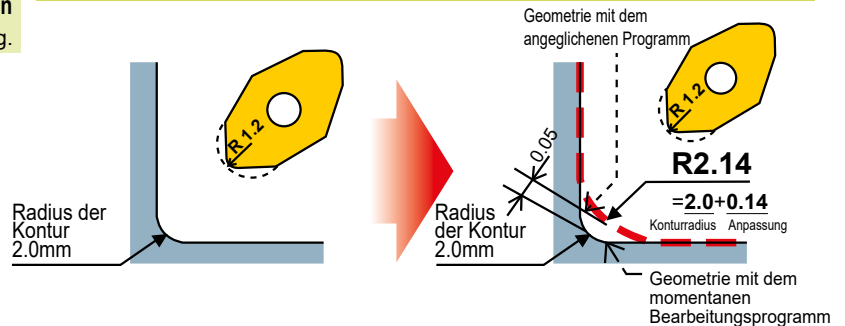

### Die Korrektur des Schneidenradius:

**Korrektur :** Es ist nicht notwendig die Bearbeitungsprogramme anzupassen, jedoch kann es zu Abweichungen von max. ±0.03mm in Folge der Radiuskorrektur kommen.

**Radiuskorrektur** Geben Sie den Korrekturwert für jeden Radius ein.

### Der Wert des korrigierten Radius = Annäherung

\*In diesem Falle keine Justierung erforderlich.

Bsp. : Bearbeitung einer Kontur mit Eckenradius 2.0mm und einer WSP mit Eckenradius 1.2mm.

Der Eckenradius der WSP	Der Wert des korrigierten Radius = Annäherung
Eckenradius 0.4 →	<b>R0.36(mm)</b>
Eckenradius 0.8 →	<b>R0.76(mm)</b>
Eckenradius 1.2 →	<b>R1.16(mm)</b>

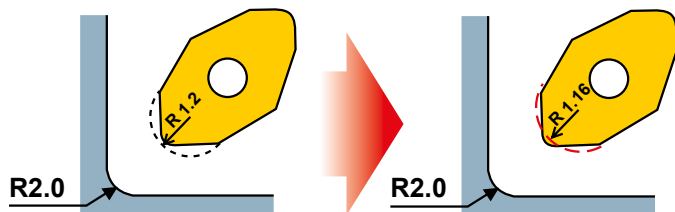

Hinweis : Die Korrekturwerte sind für DNMX und TNMX gleich. Unterschiede existieren lediglich im Bezug auf die unterschiedlichen Radien.

# SORTEN ZUM DREHEN

## WSP-SORTEN FÜR DREHEN

WSP DREHEN  
**A**

ISO	Besch. Hartmetall		Cermet	Besch. Cermet	Hartmetall	Beschichtetes PCBN	PCBN (Gesint. PCBN)	PKD (Gesint. Diamant)
	CVD	PVD						
Stahl <b>P</b>	10	MC6115 <sup>NEW</sup> UE6105 MC6015 MY5015						
	20	MC6125 <sup>NEW</sup> MC6025	VP10RT VP10MF MS6015	NX2525 NX3035	AP25N VP25N			
	30	MC6035 UH6400	VP15TF VP20MF VP20RT UP20M		MP3025 VP45N			
	40				UTi20T			
Rostfreier Stahl <b>M</b>	10	MC7015 US7020						
	20	MC7025	VP10RT VP10MF MS9025 <sup>NEW</sup>	NX2525	AP25N VP25N			
	30	MC7025 US735	VP15TF VP20MF VP20RT UP20M					
	40		MP7035					
Guss <b>K</b>	10	MC5005 MC5015 MY5015 MH515 <sup>NEW</sup>						
	20		VP10RT	NX2525	AP25N VP25N			
	30		VP15TF VP20RT					
	40					HTi05T HTi10	BC5110 <sup>NEW</sup>	MB710 MB730 MB4120 MBS140
Nicht-Eisen Metalle <b>Z</b>	10							
	20							
	30							MD220
	40							MD2030
Hitzebeständiger Stahl • Titan Leg. <b>S</b>	10	US905	MP9005 VP05RT					
	20		MP9015 VP10RT					
	30		MP9025 <sup>NEW</sup> VP20RT MS9025 <sup>NEW</sup>					
	40					MT9005 RT9005 MT9015 RT9010		MB730
Gehärteter Stahl <b>H</b>	10							
	20							
	30							
	40							BC8105 BC8110 BC8210 <sup>NEW</sup> BC8120 BC8220 <sup>NEW</sup> BC8130 MB8110 <sup>NEW</sup> MB8120 <sup>NEW</sup> MB8130 <sup>NEW</sup>

# ANWENDUNGSBEREICH DREHEN

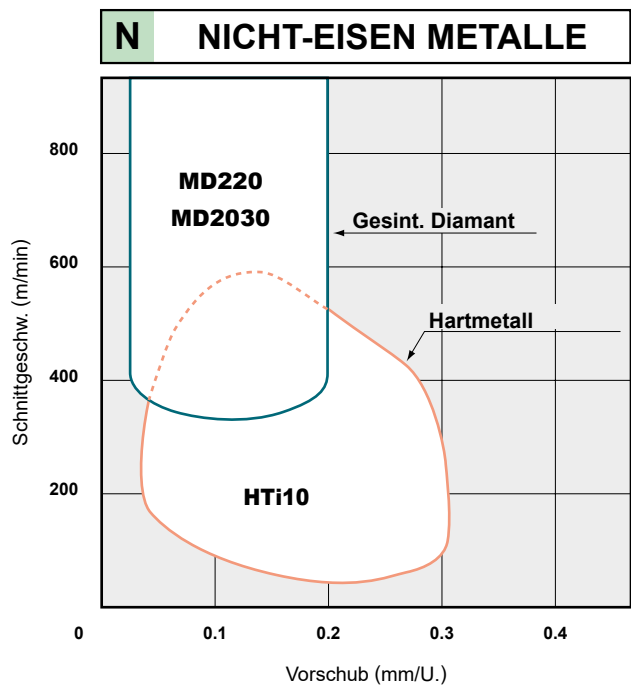
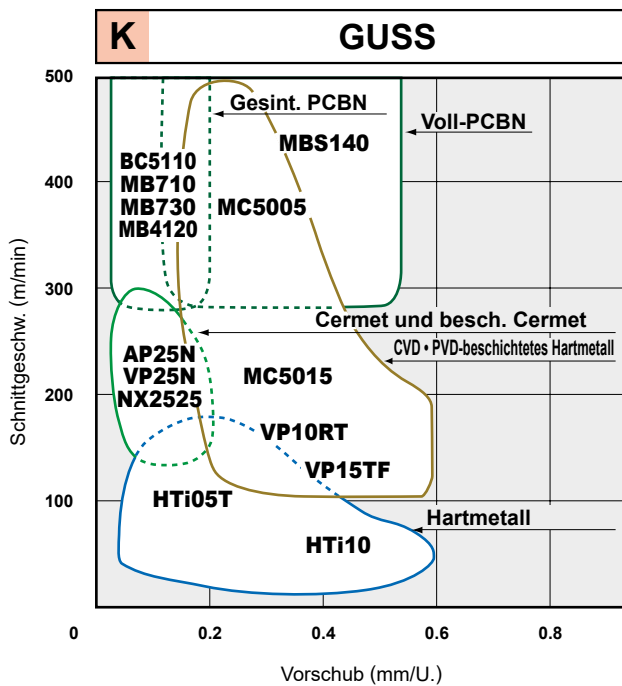
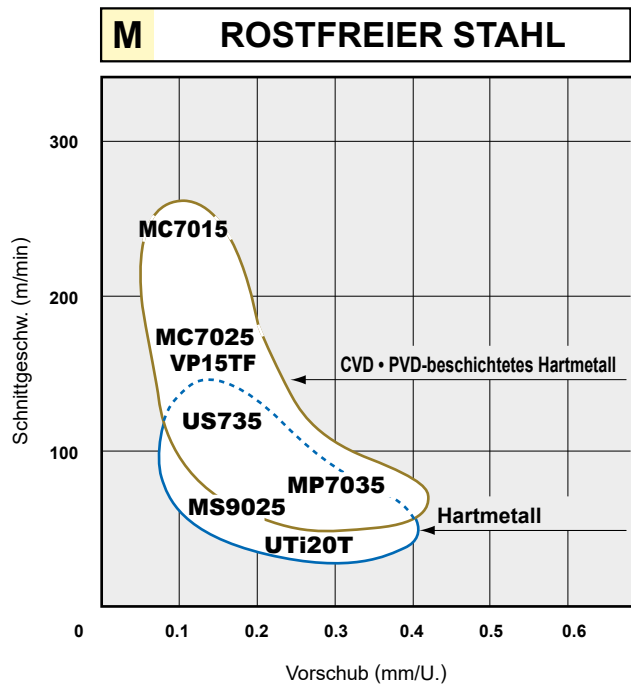
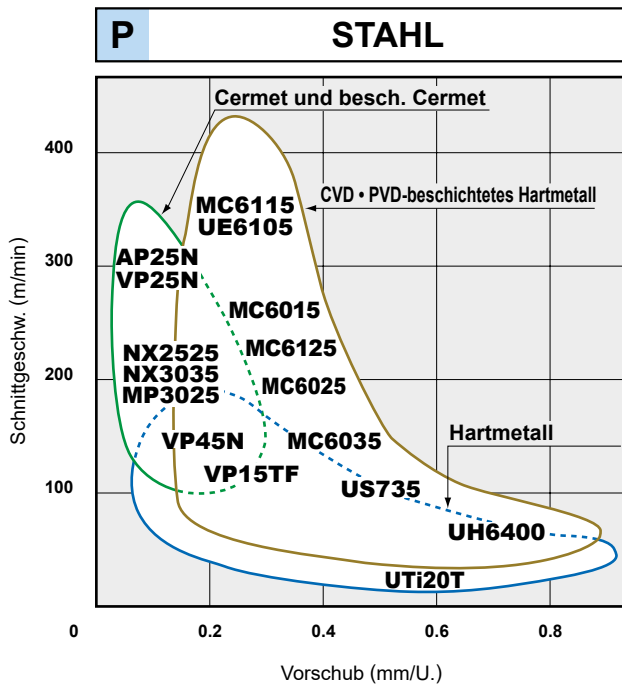

# ANWENDUNGSBEREICH DREHEN

● Empfehlung der einzusetzenden Sorten, basierend auf Schnittgeschwindigkeit und Werkstückstoff.

A

WSP DREHEN

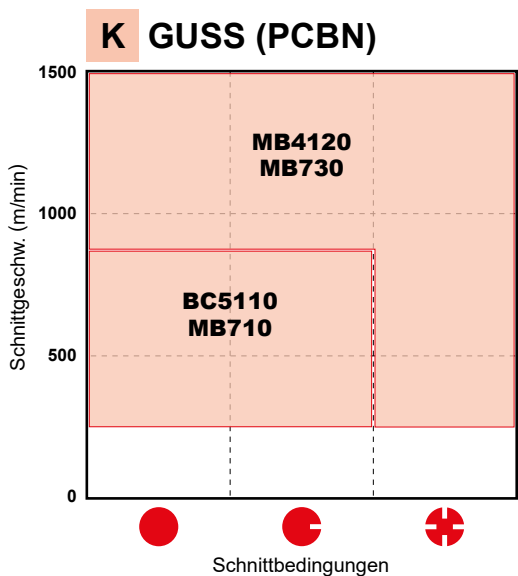
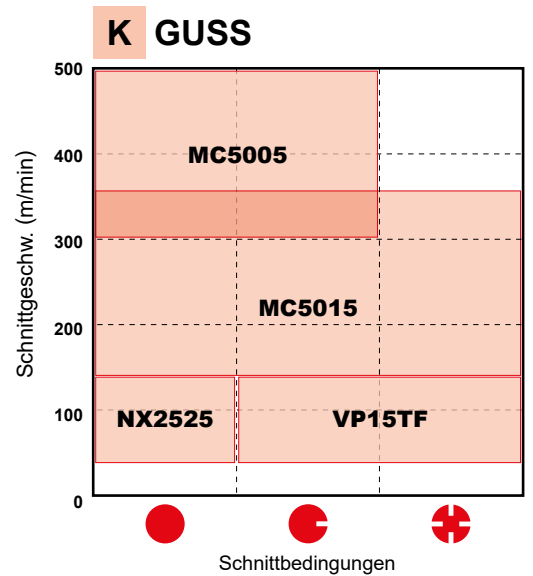
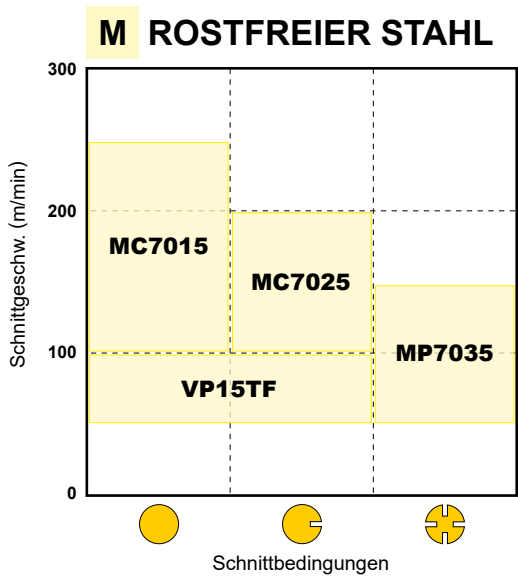
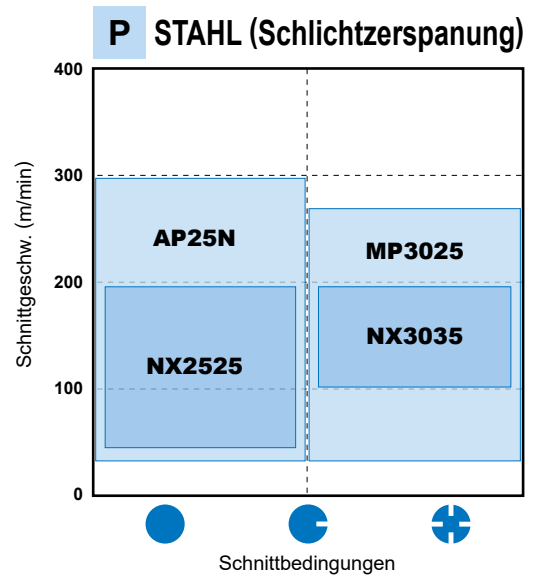
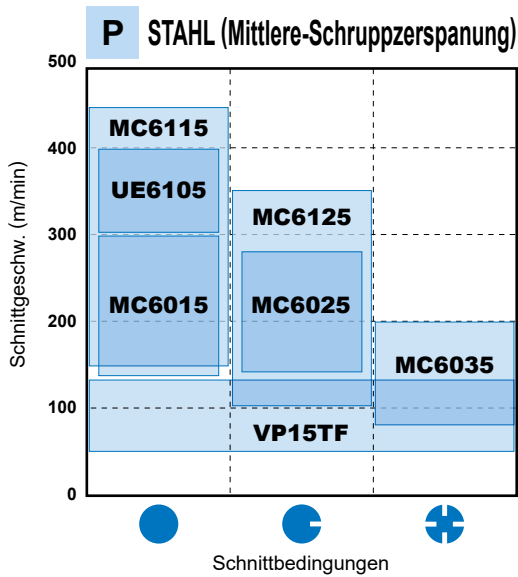

## ■ SCHNITTBEDINGUNGEN

- Stabile Bearbeitung
  - Kontinuierlicher Schnitt
  - Konstante Schnitttiefe
  - Vorbearbeitet
  - Sichere und stabile Aufspannung und Schnittbedingungen
- ◐ Allgemeine Bearbeitung
- ⊕ Instabile Bearbeitung
  - Schwerzerspannung, unterbr. Schnitt
  - Wechselnde Schnitttiefen
  - Instabile Spann- und Schnittverhältnisse

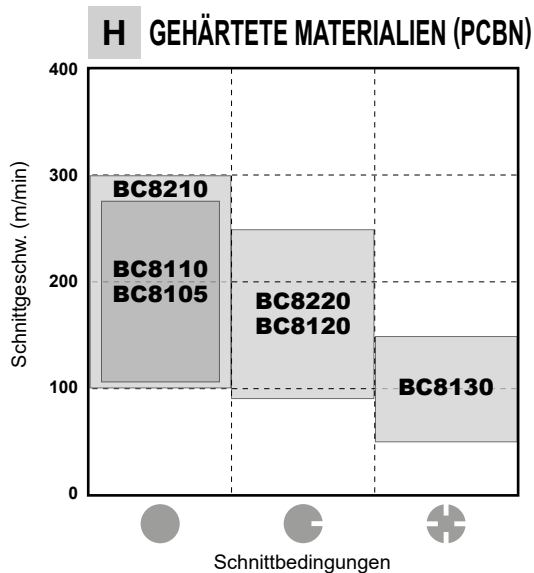
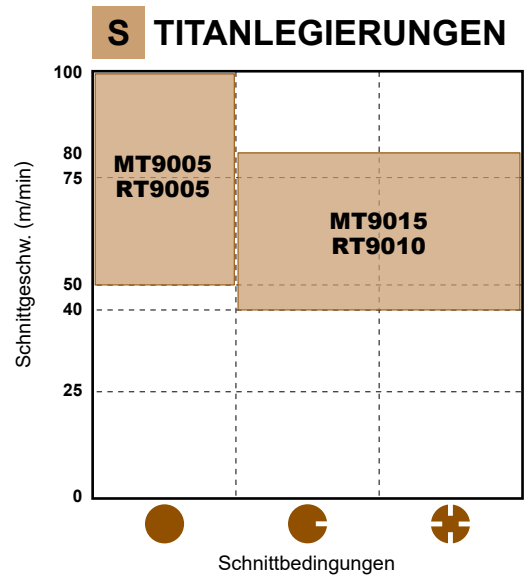
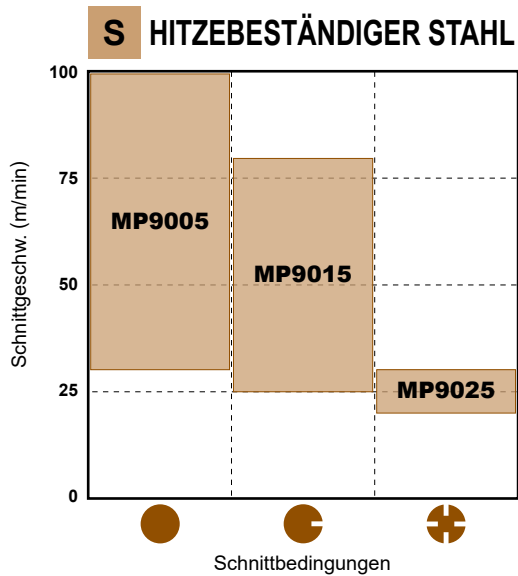
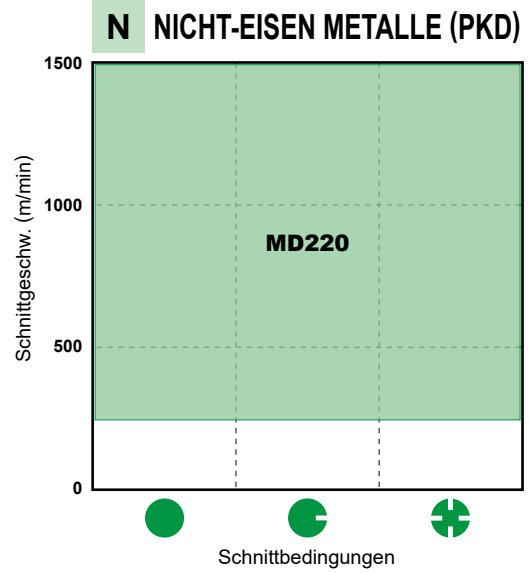
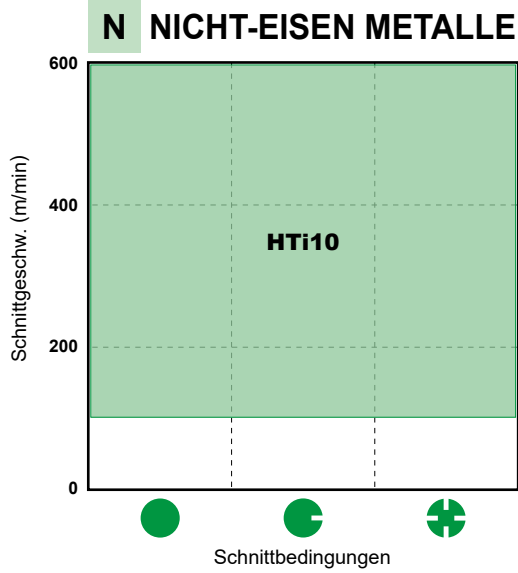

A

WSP DREHEN

# BESCH. HARTMETALL (CVD)

- Besonders zähe Lamellenstruktur erhöht die Verschleiß- und Bruchfestigkeit.
- Sehr breiter Anwendungsbereich reduziert die Anzahl der benötigten Sorten.

## STANDARD AUSWAHL

### DREHEN

WSP DREHEN

Material	Schnittmodus	Empfohlene Sorte	Empfohlene Schnittgeschwindigkeit (m/min)	ISO	Anwendungsbereich
Stahl	Kontinuierlicher Schnitt	UE6105	300 (200 – 400)	P	
		MC6115	300 (150 – 450)		
	Unterbrochener Schnitt	MC6125	200 (100 – 350)		
		MC6035	150 (80 – 200)		
Rostfreier Stahl	Kontinuierlicher Schnitt	MC7015	200 (160 – 250)	M	
		MC7025	150 (120 – 200)		
	Kontinuierlich und unterbr. Schnitt	US735	100 (80 – 120)		
Guss Duktiler Guss	Kontinuierlicher Schnitt	MC5005	300 (200 – 400)	K	
	Unterbrochener Schnitt	MC5015	250 (150 – 300)		
Hitzebeständiger Stahl	Kontinuierlich und unterbr. Schnitt	US905	80 (50 – 100)	S 5	

Deutliche Erhöhung der Stabilität und Verschleißfestigkeit durch eine verbesserte Haftung der Beschichtung und durch die neue innovative Kristallausrichtung.

## MC6115

Außenbeschichtung	●●●●●	Bessere Verschleißerkennung.
„Super“-Nano-Texture-Al <sub>2</sub> O <sub>3</sub> -Schicht	●●●●●	Hohe Verschleißfestigkeit, insbesondere bei hohen Temperaturen.
Super TOUGH-Grip	●●●●●	Starke Haftung zwischen den robusten Schichten.
Feinkörnige TiCN-Schicht	●●●●●	Beschichtung für hohe Verschleißfestigkeit.

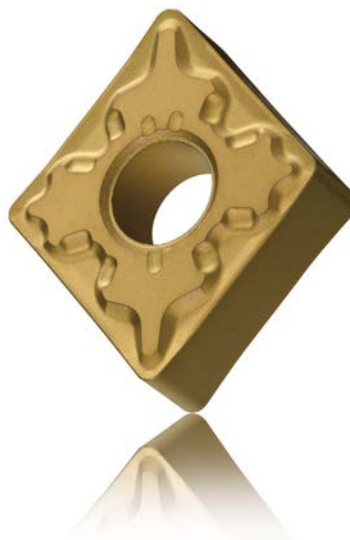

### Super Nano-Texture-Technologie

Die Nano-Texture-Technologie wurde verbessert und zu einem branchenführenden Standard für das Kristallwachstum von Al<sub>2</sub>O<sub>3</sub>-Beschichtungen weiterentwickelt. Diese Super-Nano-Texture-Technologie erhöht die Werkzeugstandzeit und die Verschleißbeständigkeit durch das feine, dichte Kristallwachstum.

### Super-Tough-Grip

Die Super-Tough-Grip-Schicht hat feinere Kristallkörner, die die Haftung zwischen den Schichten verbessern.

## ■ SORTENEIGENSCHAFTEN

Material	Sorte	Substrat	Beschichtung		
		Härte (HRA)	Zusammensetzung	Dicke	
P	Stahl	UE6105	90.8	TiCN-Al <sub>2</sub> O <sub>3</sub> -TiN - Verbund	Dick
		MC6115	90.8	TiCN-Al <sub>2</sub> O <sub>3</sub> -TiN - Verbund	Dick
		MC6015	90.2	TiCN-Al <sub>2</sub> O <sub>3</sub> -TiN - Verbund	Dick
		MC6125	90.0	TiCN-Al <sub>2</sub> O <sub>3</sub> -TiN - Verbund	Dick
		MC6025	90.2	TiCN-Al <sub>2</sub> O <sub>3</sub> -TiN - Verbund	Dick
		MC6035	89.5	TiCN-Al <sub>2</sub> O <sub>3</sub> -TiN - Verbund	Dick
		UH6400	89.5	TiCN-Al <sub>2</sub> O <sub>3</sub> -TiN - Verbund	Dick
M	Rostfreier Stahl	MC7015	90.7	TiCN-Al <sub>2</sub> O <sub>3</sub> -TiN	Dünn
		US7020	90.5	TiCN-Al <sub>2</sub> O <sub>3</sub> -TiN	Dünn
		MC7025	89.4	TiCN-Al <sub>2</sub> O <sub>3</sub> -TiN	Dünn
		US735	89.0	TiN Verbund	Dünn
K	Guss Duktiler Guss	MC5005	91.0	TiCN-Al <sub>2</sub> O <sub>3</sub>	Dick
		MC5015	91.0	TiCN-Al <sub>2</sub> O <sub>3</sub>	Dick
	Hitzebeständiger Stahlguss	MH515	91.0	TiCN-Al <sub>2</sub> O <sub>3</sub>	Dick
S	Hitzebeständiger Stahl	US905	92.2	TiCN-Al <sub>2</sub> O <sub>3</sub> -TiN	Dünn

Hinweis 1) Härte zeigt repräsentativen Wert des Substrats.

### MC6125

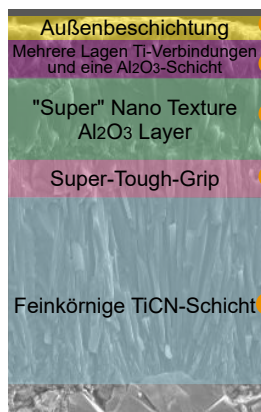

- Bessere Verschleißerkennung.
- Ausgezeichnete Verschleißbeständigkeit.
- Herausragende Verschleißfestigkeit, insbesondere bei hohen Temperaturen.
- Starke Haftung zwischen den robusten Schichten.
- Beschichtung für hohe Verschleißbeständigkeit.

**Außenbeschichtung**

Mehrere Lagen Ti-Verbindungen und eine Al<sub>2</sub>O<sub>3</sub>-Schicht

"Super" Nano Texture Al<sub>2</sub>O<sub>3</sub> Layer

Super-Tough-Grip

Feinkörnige TiCN-Schicht

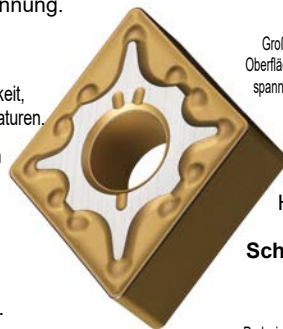

### Verstärkte Beständigkeit gegen Absplittern

Risse, die bei instabiler Bearbeitung entstehen, werden durch die geringere Eigenspannung in der Beschichtung verhindert. Die Eigenspannung in der Beschichtung der MC6100-Serie ist um 80 % geringer als bei herkömmlichen CVD-WSP.

#### Schlagbeanspruchung bei der Bearbeitung

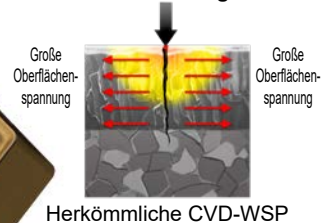

Während der Bearbeitung entstehen Risse in der Oberfläche von Beschichtungen. Sie setzen sich aufgrund der großen Oberflächenspannung in der Beschichtungsstruktur durch die Beschichtung in das Substrat fort. Das ist einer der Hauptgründe für plötzliche Ausbrüche an der WSP.

#### Schlagbeanspruchung bei der Bearbeitung

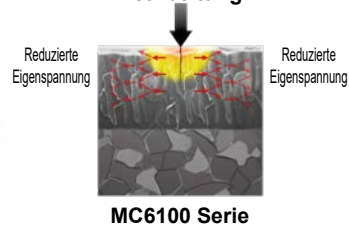

Die Beschichtung der MC6100-Serie weist ein wesentlich geringeres Spannungsniveau als herkömmliche CVD-Beschichtungen auf. Dadurch werden Schlagkräfte während der Bearbeitung verteilt und plötzliche Brüche verhindert.

Verringerung der Oberflächenspannung

# BESCH. HARTMETALL (PVD)

- Durch die PVD-Beschichtung wird unter denselben Schnittbedingungen eine längere Werkzeugzeit im Vergleich zu unbeschichtetem Hartmetall ermöglicht.
- Das Beschichten von Werkzeugen mit scharfen Schneidkanten ist ohne Beeinträchtigung des Substrates möglich.

## STANDARD AUSWAHL

### DREHEN

WSP DREHEN

Material	Empfohlene Sorte	Empfohlene Schnittgeschwindigkeit (m/min)	ISO	Anwendungsbereich
P Stahl	VP10RT	120 (100 – 150)	P 10 20 30 40	
	VP15TF	120 (100 – 150)		
	UP20M	120 (100 – 150)		
M Rostfreier Stahl	VP10RT	120 (100 – 150)	M 10 20 30 40	
	VP15TF	120 (100 – 150)		
	VP20MF	120 (100 – 150)		
	UP20M	120 (100 – 150)		
K Guss	VP10RT	120 (100 – 150)	K 10 20 30	
	VP15TF	120 (100 – 150)		
	VP20RT	120 (100 – 150)		
S Hitzebeständiger Stahl	MP9005	60 (30 – 100)	S 10 20 30	
	MP9015	50 (25 – 80)		
	MP9025	25 (20 – 30)		

## ISO Dreh-WSP für schwer zu bearbeitende Werkstoffe

NEW

### MP9005/MP9015/MP9025

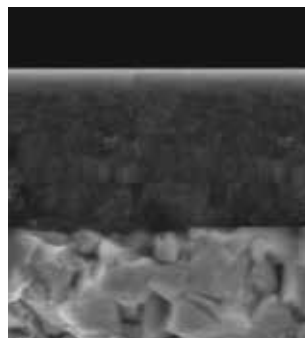

Hohe Al-(Al,Ti)N einlagige-Beschichtung

Spezielles Hartmetallsubstrat

ISO Sorte	Sorte	Eigenschaften	Anwendung
S01	MP9005	Sorte mit hoher Verschleißfestigkeit.	Hitzebeständige Legierung Schichten – Mittlere Zerspanung
S10	MP9015	Sorte mit ausgewogener Balance aus Verschleiß- und Bruchfestigkeit.	Hitzebeständige Legierung Mittlere – Schrumpferspannung
S30	NEW MP9025	Verhindert hohen Verschleiß für mehr Stabilität.	Hitzebeständige Legierung Unterbrochen • Leichte und Schrumpferspannung



## MERKMALE DER VP (MIRACLE) BESCHICHTUNG

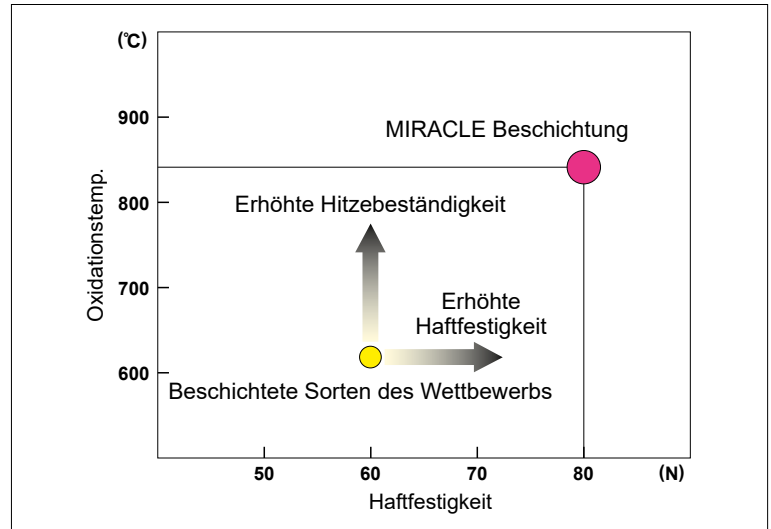

Verglichen mit herkömmlicher Beschichtungstechnologie ist die VP (MIRACLE) Beschichtung (Al,Ti,N) eine Schicht mit wesentlich höherer Hitzebeständigkeit und Haftkraft.

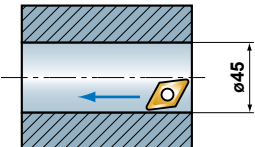
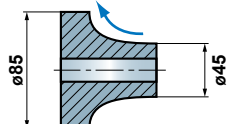
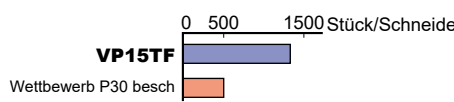
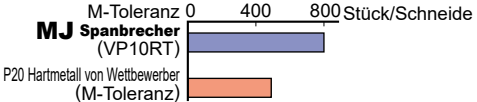

A  
WSP DREHEN

## ANWENDUNGSBEISPIELE

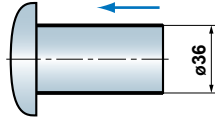
WSP (Sorte)		DCMT11T304-MV(VP15TF)	CNMG120408-MJ(VP10RT)
Material		Leg. Stahl 	Rostfreier Stahl (Ventilatorteile) 
Schnittbedingungen	Schnittgeschw. (m/min)	170	200
	Vorschub (mm/U)	0.14	0.25
	Schnitttiefe (mm)	0.25	0.5
	Kühlung	Nassbearbeitung	Nassbearbeitung
Ergebnis		 <p>VP15TF, keine Ausbrüche. Ermöglicht eine stabilere Bearbeitung mit höherer Standzeit.</p>	 <p>MJ-Spanbrecher erreicht eine um das 1.5-fache höhere Standzeit.</p>

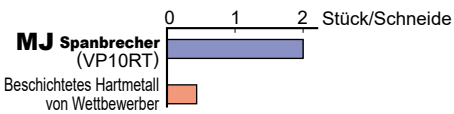
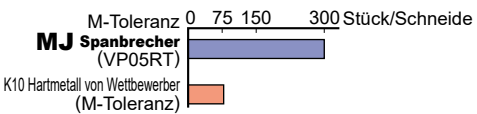
WSP (Sorte)		CNMG120408-MJ(VP10RT)	TNMG160408-MJ(VP05RT)
Material		Inconel 718 (Stift) 	Sintermetall Werkstücke (FH655) 
Schnittbedingungen	Schnittgeschw. (m/min)	31	120
	Vorschub (mm/U)	0.2	0.05
	Schnitttiefe (mm)	2.3	0.5
	Kühlung	Nassbearbeitung	Nassbearbeitung
Ergebnis		 <p>VP10RT erreicht eine um das Vierfache höhere Standzeit. MJ-Spanbrecher für hervorragende Spanabfuhr und stark erhöhte Standzeit.</p>	 <p>MJ-Spanbrecher erreicht eine um das Fünffache höhere Standzeit.</p>

# CERMET

- Das optimierte Legierungsgefüge und der spezielle "Binder" verbessern sowohl die Verschleiß- als auch die Bruchfestigkeit.
- Man hat einen sehr breiten Anwendungsbereich, und reduziert die Anzahl der benötigten Sorten.
- NX3035 für die Nassbearbeitung.
- NX2525 für die Trockenbearbeitung.

A

WSP DREHEN

## STANDARD AUSWAHL

### DREHEN

Material	Schnittmodus	Empfohlene Sorte	Empfohlene Schnittgeschwindigkeit (m/min)	ISO	Anwendungsbereich
P Stahl	Kontinuierlicher Schnitt	<b>NX2525</b>	220 (180 – 250)	P 10 20	
	Unterbrochener Schnitt	<b>NX3035</b>	200 (190 – 260)		
K Guss Duktiler Guss	Schlichten	<b>NX2525</b>	180 (150 – 210)	K 10 20	

## SORTENEIGENSCHAFTEN

Sorte	Härte (HRA)
<b>NX2525</b>	92.2
<b>NX3035</b>	91.5

Hinweis 1) Härte zeigt repräsentativen Wert des Substrats.

# BESCH. CERMET

- Beschichtetes Cermet (PVD-Beschichtung) verfügt über eine überlegene Verschleiß- und Bruchfestigkeit und bietet damit eine stabile Zerspanungsleistung.

## STANDARD AUSWAHL

### DREHEN

Material	Schnittmodus	Empfohlene Sorte	Empfohlene Schnittgeschwindigkeit (m/min)	ISO	Anwendungsbereich
P Stahl	Kontinuierlicher Schnitt	VP25N AP25N	240 (190 – 290)	P 10 20 30	
	Unterbrochener Schnitt	MP3025	230 (180 – 280)		
K Guss Duktiler Guss	Schlichten	VP25N AP25N	160 (110 – 230)	K 10 20	

A

WSP DREHEN

## Neue PVD-beschichtete Cermet Sorte

### MP3025

MP3025 bietet aufgrund des neu entwickelten Substrats eine deutlich verbesserte Schichthaftung. Ein stabiles Verschleißverhalten ermöglicht eine längere Bearbeitung und gewährleistet eine hervorragende Oberflächengüte.

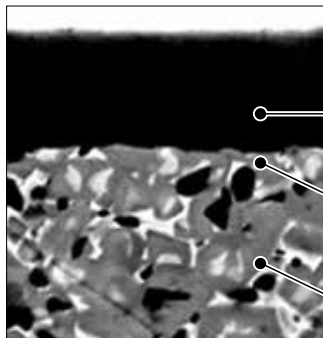

Ti-Verbund-PVD-Beschichtung bietet hervorragende Verschleiß- und Widerstand gegen Aufschweißungen.

Die Substratoberfläche bietet eine exzellente Schichthaftungseigenschaften.

Substrat mit überlegener Bruchfestigkeit und höherer Hitzebeständigkeit.

# HARTMETALL

● UTi-Sorten sind für Stahl und Gusseisen einsetzbar. Außerdem eignen sich HTi-Sorten für Eisen- und NE-Werkstoffe, sowie für Gusseisen.

## STANDARD AUSWAHL

### DREHEN

WSP DREHEN

Material	Empfohlene Sorte	Empfohlene Schnittgeschwindigkeit (m/min)	ISO	Anwendungsbereich
P Stahl	UTi20T	100 (60 – 130)	10	UTi20T
			20	
			30	
M Rostfreier Stahl	UTi20T	100 (60 – 130)	10	UTi20T
			20	
			30	
K Guss	HTi05T	120 (80 – 150)	10	HTi05T
	HTi10	100 (50 – 150)	20	HTi10
	UTi20T	100 (50 – 150)	30	UTi20T
N Nicht-Eisen Metalle	HTi10	300 (100 – 600)	10	HTi10
S Hitzebeständiger Stahl Titan Leg.	MT9005 RT9005	70 (50 – 100)	10	MT9005 RT9005
	MT9015 RT9015	60 (40 – 80)	20	MT9015 RT9015

## HAUPTBESTANDTEILE UND ANWENDUNGSBEREICH

ISO	Hauptbestandteile	Eigenschaften	Material
P	WC-TiC-TaC-Co	Widerstand gegen plast. Deformation	C-Stahl, leg. Stahl, rostfreier Stahl und Guss
K	WC-Co	Hohe Stabilität und Verschleißfestigkeit	Guss, Nichteisenmetalle und Nichtmetalle
S	WC-Co	Hoher Temperaturwiderstand sowie Verschleißfestigkeit.	Hitzebeständiger Stahl, Titanlegierung

## SORTENEIGENSCHAFTEN

ISO	Sorte	Härte (HRA)
P	UTi20T	90.5
K	HTi05T	92.5
	HTi10	92.0
S	MT9005/RT9005	92.2
	MT9015/MT9010	91.8

Hinweis 1) Härte zeigt repräsentativen Wert des Substrats.

# Notizen











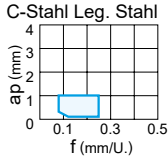

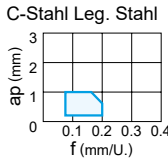
---

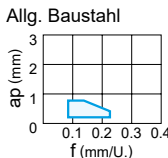

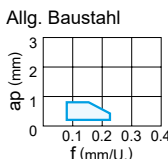

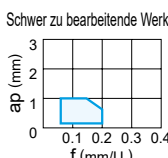
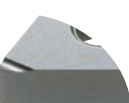
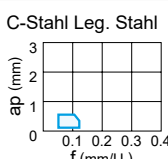
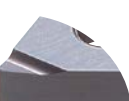
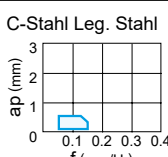

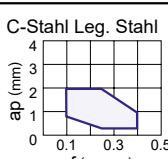

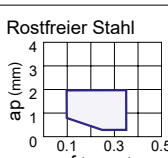







A series of horizontal dashed lines for writing notes, spanning the width of the page.

# KLASSIFIZIERUNG

## NEGATIVE WSP MIT LOCH

A  
WSP DREHEN

Anwendung	Toleranz	Spanbrecherbezeichnung und Abb.	Eigenschaften	Querschnitt Geometrie	
Schlichtzerspanung	M	<b>FP</b> 	<b>Erste Empfehlung für die Schlichtzerspanung von C-Stahl und legierten Stählen</b> Großer Spankontrollbereich sorgt bei unterschiedlichen Schnitttiefen und Vorschüben, für beste Oberflächengüten. Ein Spanwinkel von 20° in Verbindung mit der neuen Spanbrechergeometrie gewährleistet geringsten Schnittwiderstand und herausragende Schärfe der Schneide.	C-Stahl Leg. Stahl 	Ecke 20° Nebenschneidenprofil 20° CNMG120408-FP
		<b>FH</b> 	<b>Erste Empfehlung für die Schlichtzerspanung von C-Stahl und legierten Stählen</b> Doppelseitiger Spanbrecher. Stabile Spankontrolle auch bei geringen Schnitttiefen.	C-Stahl Leg. Stahl 	Ecke 12° Nebenschneidenprofil 12° CNMG120408-FH
		<b>FS</b> 	<b>Alternativer Spanbrecher für die Schlichtzerspanung von Baustahl</b> Stabile Spankontrolle auch bei geringen Schnitttiefen. Scharfe Schneidkante.	Allg. Baustahl 	Ecke 16° Nebenschneidenprofil 8° CNMG120408-FS
		<b>FY</b> 	<b>Erste Empfehlung für die Schlichtzerspanung von Baustahl</b> Effektive Kontrolle von klebenden Spänen. Geeignet zum Schlichten von Baustahl.	Allg. Baustahl 	Ecke 15° Nebenschneidenprofil 15° 0.2 mm CNMG120408-FY
		<b>FJ</b> 	<b>Alternativer Spanbrecher für die Schlichtzerspanung von schwer zerspanbaren Werkstoffen</b> Ideal für warmfeste sowie Titanlegierungen. Scharfe Schneidkante sorgt für eine gute Oberflächengüte. Geschwungene Schneidkante ermöglicht einen weichen Schnitt.	Schwer zu bearbeitende Werkstoffe 	Ecke 14° Nebenschneidenprofil 9° CNGG120404-FJ
		<b>R/L-FS</b> 	<b>Für das Feinstschlichten mit hoher Präzision</b> Kleine Spanleitstufe für leichte Spanabfuhr. Scharfe Schneidkante sorgt für eine gute Oberflächengüte.	C-Stahl Leg. Stahl 	Nebenschneidenprofil 14° TNGG160404R-FS
Leichtzerspanung	M	<b>R/L-F</b> 	<b>Für das Schlichten mit hoher Präzision</b> Spanleitstufe für leichte Spanabfuhr. Scharfe Schneidkante sorgt für eine gute Oberflächengüte.	C-Stahl Leg. Stahl 	Nebenschneidenprofil 14° TNGG160404R-F
		<b>LP</b> 	<b>Erste Empfehlung für die Leichtzerspanung von allgemeinen und legierten Stahlorten</b> Stabile Spankontrolle bei leichter Zerspanung. Geschwungene Schneidkante ermöglicht eine weiche Spanabfuhr.	C-Stahl Leg. Stahl 	Ecke 15° Nebenschneidenprofil 11° 0.1 mm 0.2 mm CNMG120408-LP
		<b>LM</b> 	<b>Erste Empfehlung für die Leichtzerspanung von rostfreiem Stahl</b> Hohe Spankontrolle bei kleinen Schnitttiefen. Deutliche Reduzierung der Gratbildung durch optimierte Schärfeigenschaften und Schneidkantenstärke für verschiedene Spanwinkel.	Rostfreier Stahl 	Ecke 15° Nebenschneidenprofil 20° 0.50 mm CNMG120408-LM

	Rhombus 80° 	Rhombus 55° 	Vierkant 90° 	Dreikant 60° 	Rhombus 35° 	Sechskant 80° 	Rund 	Spanbrecher Bezeichnung und Schnittbild
	<b>CNMG_FP</b>  ↻ A098	<b>DNMG_FP</b>  ↻ A105	<b>SNMG_FP</b>  ↻ A113	<b>TNMG_FP</b>  ↻ A119	<b>VNMG_FP</b>  ↻ A126	<b>WNMG_FP</b>  ↻ A130		<b>FP</b> 
	<b>CNMG_FH</b>  ↻ A098	<b>DNMG_FH</b>  ↻ A105	<b>SNMG_FH</b>  ↻ A113	<b>TNMG_FH</b>  ↻ A119	<b>VNMG_FH</b>  ↻ A126	<b>WNMG_FH</b>  ↻ A130		<b>FH</b> 
	<b>CNMG_FS</b>  ↻ A098	<b>DNMG_FS</b>  ↻ A105	<b>SNMG_FS</b>  ↻ A113	<b>TNMG_FS</b>  ↻ A119	<b>VNMG_FS</b>  ↻ A126	<b>WNMG_FS</b>  ↻ A130		<b>FS</b> 
	<b>CNMG_FY</b>  ↻ A098	<b>DNMG_FY</b>  ↻ A105		<b>TNMG_FY</b>  ↻ A119		<b>WNMG_FY</b>  ↻ A130		<b>FY</b> 
	<b>CNGG_FJ</b>  ↻ A098	<b>DNGG_FJ</b>  ↻ A105			<b>VNMG_FJ</b>  ↻ A126			<b>FJ</b> 
				<b>TNGG_R/L-FS</b>  ↻ A119				<b>R/L-FS</b> 
				<b>TNGG_R/L-F</b>  ↻ A119	<b>VNMG_R/L-F</b>  ↻ A126			<b>R/L-F</b> 
	<b>CNMG_LP</b>  ↻ A098	<b>DNMG_LP</b>  ↻ A106	<b>SNMG_LP</b>  ↻ A113	<b>TNMG_LP</b>  ↻ A120	<b>VNMG_LP</b>  ↻ A126	<b>WNMG_LP</b>  ↻ A130		<b>LP</b> 
	<b>CNMG_LM</b>  ↻ A098	<b>DNMG_LM</b>  ↻ A106	<b>SNMG_LM</b>  ↻ A113	<b>TNMG_LM</b>  ↻ A120	<b>VNMG_LM</b>  ↻ A126	<b>WNMG_LM</b>  ↻ A130		<b>LM</b> 











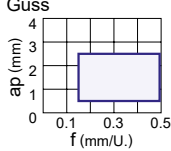

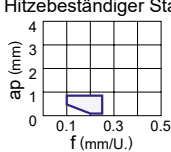

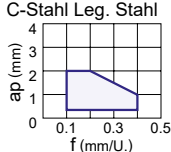

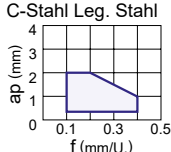
A

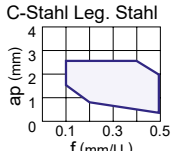
WSP DREHEN

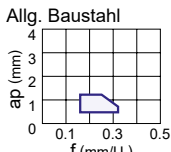
# KLASSIFIZIERUNG

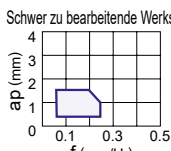
## NEGATIVE WSP MIT LOCH

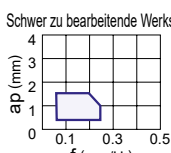
A  
WSP DREHEN

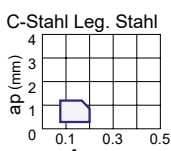
Anwendung	Toleranz	Spanbrecherbezeichnung und Abb.	Eigenschaften	Querschnitt Geometrie			
Leichtzerspanung	M	<b>LK</b> 	<b>Erste Empfehlung für die Leichtzerspannung von Gusseisen</b> Positive Primärfase ermöglicht eine scharfe Schneidkante und einen reduzierten Schnittwiderstand.	Guss 	Nebenschneidenprofil 15° 0.15 mm 6° CNMG120408-LK		
		<b>LS</b> 	<b>Erste Empfehlung für die Leichtzerspannung von schwer zerspanbaren Werkstoffen</b> <b>Alternativer Spanbrecher für die leichte Zerspannung von rostfreiem Stahl</b> Geometrie mit hoher Schärfe für eine verbesserte Spanabfuhr. Ideal für Bearbeitungen mit kleinen Schnitttiefen.	Hitzebeständiger Stahl 	20° 0.4 mm Ecke 20° Nebenschneidenprofil 0.6 mm CNMG120408-LS		
		<b>SH</b> 	<b>Alternativer Spanbrecher für die Leichtzerspannung von allgemeinen und legierten Stahlsorten</b> Für geringe Schnitttiefen und hohe Vorschübe. Geschwungene Schneidkante ermöglicht einen weichen Schnitt. Empfohlen für Werkstücke im Härtebereich 160–250HB.	C-Stahl Leg. Stahl 	15° Ecke 15° Nebenschneidenprofil 0.2 mm CNMG120408-SH		
		<b>SA</b> 	<b>Alternativer Spanbrecher für die Leichtzerspannung von allgemeinen und legierten Stahlsorten</b> Sehr hohe Spankontrolle bei geringen Schnitttiefen. Wellige Schneidkanten für das Kopier- und Plandrehen. Empfohlen für Werkstücke im Härtebereich 200–300HB.	C-Stahl Leg. Stahl 	25° Ecke 10° 25° Nebenschneidenprofil 0.34 mm 8° CNMG120408-SA		
		<b>SW</b> 	<b>Wiper-WSP für die leichte Zerspannung von C-Stahl, legierten Stählen, rostfreiem Stahl und Gusseisen</b> Anders als bei herkömmlichen Spanbrechern bleibt die Oberflächenqualität auch bei einer Verdoppelung des Vorschubs pro Umdrehung erhalten. Wiper-Geometrie gewährleistet höhere Produktivität und bessere Oberflächen.	C-Stahl Leg. Stahl 	18° Ecke 7° 18° Nebenschneidenprofil 0.15 mm 7° CNMG120408-SW		
		<b>SY</b> 	<b>Erste Empfehlung für die Leichtzerspannung von Baustahl</b> Effektive Kontrolle von klebenden Spänen. Geeignet zum leichten Zerspanen von Baustahl.	Allg. Baustahl 	10° Ecke 10° Nebenschneidenprofil 0.2 mm CNMG120408-SY		
		<b>MJ</b> 	<b>Alternativer Spanbrecher für die leichte Zerspannung von schwer zerspanbaren Werkstoffen</b> Ideal für warmfeste oder Titanlegierungen. Scharfe Schneidkante sorgt für eine gute Oberflächengüte. Geschwungene Schneidkante ermöglicht einen weichen Schnitt. Hervorragender Kerbverschleißwiderstand für leichte bis mittlere Zerspanung.	Schwer zu bearbeitende Werkstoffe 	13° Ecke 9° Nebenschneidenprofil CNMG120408-MJ		
		<b>MJ</b> 	<b>Alternativer Spanbrecher für die leichte Zerspannung von schwer zerspanbaren Werkstoffen</b> Doppelseitiger Spanbrecher, einseitiger Spanbrecher (D Halter, V Halter). Scharfe Schneidkante sorgt für eine gute Oberflächengüte. Ideal für warmfeste und Titanlegierungen. Geschwungene Schneidkante ermöglicht einen weichen Schnitt.	Schwer zu bearbeitende Werkstoffe 	13° Ecke 9° Nebenschneidenprofil CNGG120408-MJ		
		G		<b>R/L-K</b> 	<b>Für die Leichtzerspannung</b> Parallele Spanleitstufe. Hohe Spankontrolle bei kleinen bis mittleren Vorschüben.	C-Stahl Leg. Stahl 	Nebenschneidenprofil 14° 0.25 mm TNGG160404R-K



	Rhombus 80° 	Rhombus 55° 	Vierkant 90° 	Dreikant 60° 	Rhombus 35° 	Sechskant 80° 	Rund 	Spanbrecher Bezeichnung und Schnittbild
	<b>CNMG_LK</b>  ↻ A099	<b>DNMG_LK</b>  ↻ A106	<b>SNMG_LK</b>  ↻ A113	<b>TNMG_LK</b>  ↻ A120	<b>VNMG_LK</b>  ↻ A127	<b>WNMG_LK</b>  ↻ A131		<b>LK</b> 
	<b>CNMG_LS</b>  ↻ A099	<b>DNMG_LS</b>  ↻ A106		<b>TNMG_LS</b>  ↻ A120	<b>VNMG_LS</b>  ↻ A127	<b>WNMG_LS</b>  ↻ A131		<b>LS</b> 
	<b>CNMG_SH</b>  ↻ A099	<b>DNMG_SH</b>  ↻ A106	<b>SNMG_SH</b>  ↻ A113	<b>TNMG_SH</b>  ↻ A120	<b>VNMG_SH</b>  ↻ A127	<b>WNMG_SH</b>  ↻ A131		<b>SH</b> 
	<b>CNMG_SA</b>  ↻ A099	<b>DNMG_SA</b>  ↻ A107	<b>SNMG_SA</b>  ↻ A114	<b>TNMG_SA</b>  ↻ A120	<b>VNMG_SA</b>  ↻ A127	<b>WNMG_SA</b>  ↻ A131		<b>SA</b> 
	<b>CNMG_SW</b>  ↻ A099	<b>DNMX_SW</b>  ↻ A107		<b>TNMX_SW</b>  ↻ A120		<b>WNMG_SW</b>  ↻ A131		<b>SW</b> 
	<b>CNMG_SY</b>  ↻ A099	<b>DNMG_SY</b>  ↻ A107	<b>SNMG_SY</b>  ↻ A114	<b>TNMG_SY</b>  ↻ A121		<b>WNMG_SY</b>  ↻ A131		<b>SY</b> 
	<b>CNMG_MJ</b>  ↻ A099	<b>DNMG_MJ</b>  ↻ A107		<b>TNMG_MJ</b>  ↻ A121	<b>VNMG_MJ</b>  ↻ A127	<b>WNMG_MJ</b>  ↻ A131		<b>MJ(M)</b> 
	<b>CNGG_MJ</b>  ↻ A099	<b>DNGM_MJ</b>  ↻ A107			<b>VNGM_MJ</b>  ↻ A127			<b>MJ(G)</b> 
				<b>TNGG_R/L-K</b>  ↻ A121				<b>R/L-K</b> 











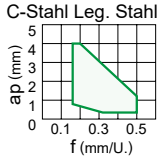

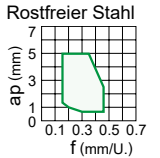

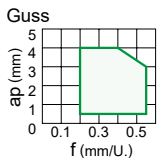

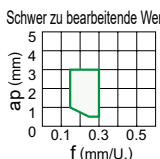
A  
WSP DREHEN

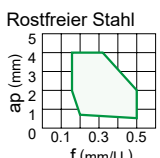

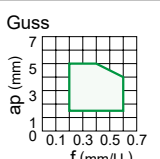

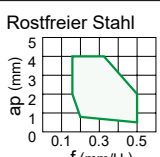

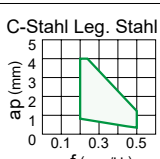
# KLASSIFIZIERUNG

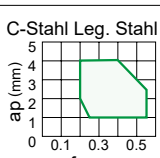
## NEGATIVE WSP MIT LOCH

A

WSP DREHEN

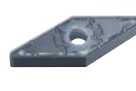
Anwendung	Toleranz	Spanbrecherbezeichnung und Abb.	Eigenschaften		Querschnitt Geometrie
Mittlere Zerspanung	M	<p><b>MP</b></p> 	<p><b>Erste Empfehlung für die mittlere Zerspanung von allgemeinen und legierten Stahlsorten</b></p> <p>Geeignet für mittleres bis leichtes Zerspanen. Geometrie ermöglicht Kopierdrehen und Hinterdrehen. Schneidengeometrie für ein optimales Gleichgewicht aus Schärfe und Bruchfestigkeit.</p>	<p>C-Stahl Leg. Stahl</p> 	<p>15° 0.15 mm Ecke</p> <p>11° 0.2 mm Nebenschneidenprofil</p> <p>CNMG120408-MP</p>
		<p><b>MM</b></p> 	<p><b>Erste Empfehlung für die mittlere Zerspanung von rostfreiem Stahl</b></p> <p>Hoher Widerstand gegen plastische Deformation. Hohe Standzeit in einem breiten Anwendungsbereich. Exzellente Balance aus Schärfe und Schneidkantenstabilität.</p>	<p>Rostfreier Stahl</p> 	<p>6° 0.3 mm Ecke</p> <p>10° 0.3 mm Nebenschneidenprofil</p> <p>CNMG120408-MM</p>
		<p><b>MK</b></p> 	<p><b>Erste Empfehlung für die mittlere Zerspanung von Gusseisen</b></p> <p>Exzellente Balance aus Schärfe und Schneidkantenstabilität. Für einen breiten Anwendungsbereich und multifunktionale Bearbeitung.</p>	<p>Guss</p> 	<p>Nebenschneidenprofil</p> <p>15° 0.25 mm</p> <p>3°</p> <p>CNMG120408-MK</p>
		<p><b>MS</b></p> 	<p><b>Erste Empfehlung für die mittlere Zerspanung von rostfreiem Stahl, legiertem Stahl und schwer zu bearbeitender Werkstoffe</b></p> <p>Der große, zweistufige Spanwinkel erzeugt auch bei langsamen Vorschub gleichförmige Späne, die sich nicht verhaken.</p>	<p>Schwer zu bearbeitende Werkstoffe</p> 	<p>25° 0.5 mm Ecke</p> <p>15° 0.5 mm Nebenschneidenprofil</p> <p>15°</p> <p>CNMG120408-MS</p>
		<p><b>MS</b></p> 	<p><b>Alternativer Spanbrecher für mittlere Zerspanung von rostfreiem Stahl, Baustahl und schwer zerspanbaren Werkstoffen</b></p> <p>Die scharfe Schneidkante ermöglicht hohe Leistung. Die glatte Spanbrecherform sorgt für eine hohe Schneidkantenfestigkeit. Anwendbar für alle Sorten außer MP9005, MP9015, MP9025, MT9015</p>	<p>Rostfreier Stahl</p> 	<p>25° 0.5 mm Ecke</p> <p>15° 0.5 mm Nebenschneidenprofil</p> <p>15°</p> <p>CNMG120408-MS</p>
		<p><b>GK</b></p> 	<p><b>Alternativer Spanbrecher für leichte bis mittlere Zerspanung von Gusseisen</b></p> <p>Multifunktionaler Spanbrecher mit stabiler Schneide.</p>	<p>Guss</p> 	<p>Nebenschneidenprofil</p> <p>15° 0.25 mm</p> <p>CNMG120408-GK</p>
		<p><b>GM</b></p> 	<p><b>Alternativer Spanbrecher für leichte bis mittlere Zerspanung von rostfreiem Stahl</b></p> <p>Alternativer Spanbrecher für LM- und MM-Spanbrecher. Ausgezeichneter Kernverschleißwiderstand für leichte bis mittlere Zerspanung.</p>	<p>Rostfreier Stahl</p> 	<p>25° 0.5 mm Ecke</p> <p>15° 0.5 mm Nebenschneidenprofil</p> <p>15°</p> <p>CNMG120408-GM</p>
		<p><b>MA</b></p> 	<p><b>Multi-Assist-Spanbrecher</b></p> <p>Ideal für allgemeine Zerspanungsanwendungen. Positive Primärfase sorgt für scharfe Schneidkante.</p>	<p>C-Stahl Leg. Stahl</p> 	<p>22° 0.2 mm Ecke</p> <p>6° 0.2 mm Nebenschneidenprofil</p> <p>22° 0.2 mm</p> <p>6°</p> <p>CNMG120408-MA</p>
		<p><b>MH</b></p> 	<p><b>Erste Empfehlung für das Schruppen von Baustahl</b> <b>Alternativer Spanbrecher für die mittlere Zerspanung von allgemeinen und legierten Stahlsorten</b></p> <p>Gute Spankontrolle mit geeigneter Spankammer.</p>	<p>C-Stahl Leg. Stahl</p> 	<p>16° 0.25 mm Ecke</p> <p>16° 0.35 mm Nebenschneidenprofil</p> <p>CNMG120408-MH</p>

	Rhombus 80° 	Rhombus 55° 	Vierkant 90° 	Dreikant 60° 	Rhombus 35° 	Sechskant 80° 	Rund 	Spanbrecher Bezeichnung und Schnittbild
	<b>CNMG_MP</b>  ↻ A100	<b>DNMG_MP</b>  ↻ A107	<b>SNMG_MP</b>  ↻ A114	<b>TNMG_MP</b>  ↻ A121	<b>VNMG_MP</b>  ↻ A127	<b>WNMG_MP</b>  ↻ A132		<b>MP</b> 
	<b>CNMG_MM</b>  ↻ A100	<b>DNMG_MM</b>  ↻ A107	<b>SNMG_MM</b>  ↻ A114	<b>TNMG_MM</b>  ↻ A121	<b>VNMG_MM</b>  ↻ A127	<b>WNMG_MM</b>  ↻ A132		<b>MM</b> 
	<b>CNMG_MK</b>  ↻ A100	<b>DNMG_MK</b>  ↻ A108	<b>SNMG_MK</b>  ↻ A114	<b>TNMG_MK</b>  ↻ A121	<b>VNMG_MK</b>  ↻ A127	<b>WNMG_MK</b>  ↻ A132		<b>MK</b> 
	<b>CNMG_MS</b>  ↻ A100	<b>DNMG_MS</b>  ↻ A108	<b>SNMG_MS</b>  ↻ A114	<b>TNMG_MS</b>  ↻ A121	<b>VNMG_MS</b>  ↻ A128	<b>WNMG_MS</b>  ↻ A132		<b>MS</b> 
	<b>CNMG_MS</b>  ↻ A101	<b>DNMG_MS</b>  ↻ A108	<b>SNMG_MS</b>  ↻ A115	<b>TNMG_MS</b>  ↻ A121	<b>VNMG_MS</b>  ↻ A128	<b>WNMG_MS</b>  ↻ A132		<b>MS</b> 
	<b>CNMG_GK</b>  ↻ A101	<b>DNMG_GK</b>  ↻ A108	<b>SNMG_GK</b>  ↻ A115	<b>TNMG_GK</b>  ↻ A121	<b>VNMG_GK</b>  ↻ A128	<b>WNMG_GK</b>  ↻ A133		<b>GK</b> 
	<b>CNMG_GM</b>  ↻ A101	<b>DNMG_GM</b>  ↻ A108	<b>SNMG_GM</b>  ↻ A115	<b>TNMG_GM</b>  ↻ A122	<b>VNMG_GM</b>  ↻ A128	<b>WNMG_GM</b>  ↻ A133		<b>GM</b> 
	<b>CNMG_MA</b>  ↻ A101	<b>DNMG_MA</b>  ↻ A109	<b>SNMG_MA</b>  ↻ A115	<b>TNMG_MA</b>  ↻ A122	<b>VNMG_MA</b>  ↻ A128	<b>WNMG_MA</b>  ↻ A133		<b>MA</b> 
	<b>CNMG_MH</b>  ↻ A101	<b>DNMG_MH</b>  ↻ A109	<b>SNMG_MH</b>  ↻ A115	<b>TNMG_MH</b>  ↻ A122	<b>VNMG_MH</b>  ↻ A128	<b>WNMG_MH</b>  ↻ A133		<b>MH</b> 











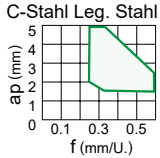

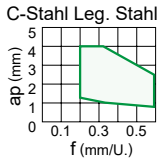

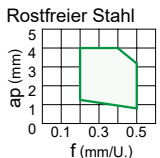

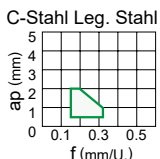
**A**  
WSP DREHEN

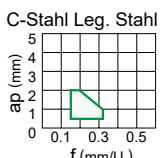

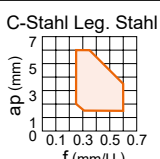

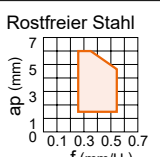

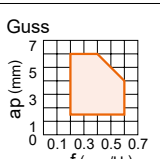

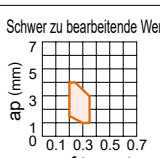
# KLASSIFIZIERUNG

## NEGATIVE WSP MIT LOCH

WSP DREHEN

A

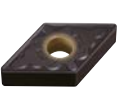
Anwendung	Toleranz	Spanbrecherbezeichnung und Abb.	Eigenschaften		Querschnitt Geometrie
Mittlere Zerspanung	M	<b>Standard</b> 	<b>Alternativer Spanbrecher für die mittlere Zerspannung von allgemeinen und legierten Stahlsorten</b> <b>Option für das mittlere Zerspanen von Gusseisen</b> Die flache Primärfase sorgt für eine hohe Schneidkantenstabilität. Die glatte Spanbrecherform sorgt für eine hohe Schneidkantenfestigkeit.	C-Stahl Leg. Stahl 	15° 0.25 mm Ecke 15° 0.25 mm Nebenschneidenprofil CNMG120408
		<b>MW</b> 	<b>Wiper-WSP für die mittlere Zerspannung von C-Stahl, legierten Stählen, rostfreiem Stahl und Gusseisen</b> Wiper Geometrie, ermöglicht doppelte Vorschübe bei gleicher Oberflächengüte. Große Spankammer ermöglicht einfache Spanabfuhr.	C-Stahl Leg. Stahl 	19° 0.25 mm Ecke 19° 0.3 mm Nebenschneidenprofil CNMG120408-MW
		<b>R/L-ES</b> 	<b>Alternative Spanbrecher für die mittlere Zerspannung von rostfreiem Stahl</b> Gute Balance zwischen Schneidkantenschärfe und Stabilität. Spanbrecher als Links- und Rechtsausführung lieferbar.	Rostfreier Stahl 	15° 0.16 mm Nebenschneidenprofil TNMG160404R-ES
		<b>R/L-2G</b> 	<b>Alternativer Spanbrecher für die mittlere Zerspannung von allgemeinen und legierten Stahlsorten</b> Parallelschanbrecher kontrollieren den Spanablauf. Geeignet für leichtes bis mittleres Zerspanen.	C-Stahl Leg. Stahl 	14° 0.2 mm Nebenschneidenprofil TNMG160404R-2G
		<b>R/L</b> 	<b>Für die mittlere Zerspanung</b> Parallele Spanleitstufe. Hohe Spankontrolle bei mittleren Vorschüben.	C-Stahl Leg. Stahl 	14° 0.25 mm Nebenschneidenprofil TNGG160408R
Schruppzerspanung	M	<b>RP</b> 	<b>Erste Empfehlung für die Schruppzerspanung von allgemeinen und legierten Stahlsorten</b> Für unterbrochene Schnitte und Entfernung von Zunder. Gute Balance zwischen Schneidkantenschärfe und Stabilität.	C-Stahl Leg. Stahl 	3° 0.33 mm Ecke 0.33 mm Nebenschneidenprofil CNMG120408-RP
		<b>RM</b> 	<b>Erste Empfehlung für die Schruppzerspanung von rostfreiem Stahl</b> Hohe Schneidkantenstabilität für eine prozesssichere Bearbeitung.	Rostfreier Stahl 	3° 0.32 mm Ecke 6° 0.32 mm Nebenschneidenprofil CNMG120408-RM
		<b>RK</b> 	<b>Erste Empfehlung für die Schruppzerspanung von Gusseisen</b> Breite Primärfase sorgt für eine stabile Schneidkante für unterbrochene Bearbeitungen und die Entfernung von Zunder.	Guss 	15° 0.35 mm Nebenschneidenprofil CNMG120408-RK
		<b>RS</b> 	<b>Erste Empfehlung für die Schruppzerspanung von schwer zu bearbeitender Werkstoffe</b> <b>Alternativer Spanbrecher für die Schruppzerspanung von rostfreien Stählen</b> Doppelseitiger Spanbrecher. Hohe Schneidkantenstabilität für eine prozesssichere Bearbeitung.	Schwer zu bearbeitende Werkstoffe 	20° 0.2 mm Ecke 10° 0.2 mm 20° 0.2 mm 10° Nebenschneidenprofil CNMG120408-RS

	Rhombus 80° 	Rhombus 55° 	Vierkant 90° 	Dreikant 60° 	Rhombus 35° 	Sechskant 80° 	Rund 	Spanbrecher Bezeichnung und Schnittbild
	<b>CNMG</b>  ↻ A102	<b>DNMG</b>  ↻ A109	<b>SNMG</b>  ↻ A115	<b>TNMG</b>  ↻ A122	<b>VNMG</b>  ↻ A128	<b>WNMG</b>  ↻ A133	<b>RNMG</b>  ↻ A112	<b>Standard</b> 
	<b>CNMG_MW</b>  ↻ A102	<b>DNMX_MW</b>  ↻ A109		<b>TNMX_MW</b>  ↻ A123		<b>WNMG_MW</b>  ↻ A133		<b>MW</b> 
				<b>TNMG_R/L-ES</b>  ↻ A123				<b>R/L-ES</b> 
				<b>TNMG_R/L-2G</b>  ↻ A123				<b>R/L-2G</b> 
		<b>DNGG_R/L</b>  ↻ A109	<b>SNGG_R/L</b>  ↻ A116	<b>TNGG_R/L</b>  ↻ A123	<b>VNGG_R/L</b>  ↻ A129			<b>R/L</b> 
	<b>CNMG_RP</b>  ↻ A102	<b>DNMG_RP</b>  ↻ A109	<b>SNMG_RP</b>  ↻ A116	<b>TNMG_RP</b>  ↻ A123		<b>WNMG_RP</b>  ↻ A133		<b>RP</b> 
	<b>CNMG_RM</b>  ↻ A102	<b>DNMG_RM</b>  ↻ A110	<b>SNMG_RM</b>  ↻ A116	<b>TNMG_RM</b>  ↻ A123		<b>WNMG_RM</b>  ↻ A133		<b>RM</b> 
	<b>CNMG_RK</b>  ↻ A103	<b>DNMG_RK</b>  ↻ A110	<b>SNMG_RK</b>  ↻ A116	<b>TNMG_RK</b>  ↻ A124		<b>WNMG_RK</b>  ↻ A134		<b>RK</b> 
	<b>CNMG_RS</b>  ↻ A103	<b>DNMG_RS</b>  ↻ A110	<b>SNMG_RS</b>  ↻ A116	<b>TNMG_RS</b>  ↻ A124		<b>WNMG_RS</b>  ↻ A134		<b>RS</b> 











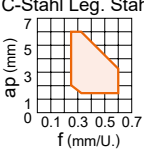

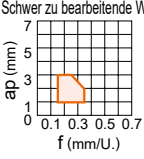

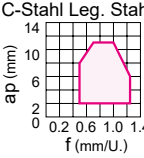

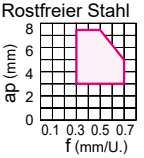
A  
WSP DREHEN

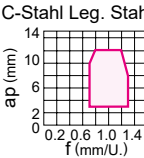

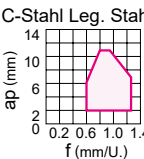

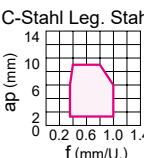

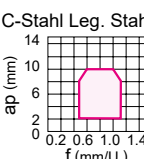

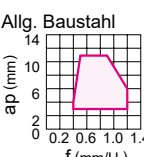









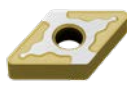





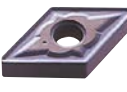





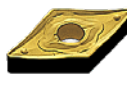







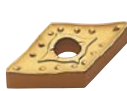

# KLASSIFIZIERUNG

## NEGATIVE WSP MIT LOCH

A  
WSP DREHEN

Anwendung	Toleranz	Spanbrecherbezeichnung und Abb.	Eigenschaften	Querschnitt Geometrie
Schruppzerspannung	M	<b>GH</b> 	<b>Alternativer Spanbrecher für die Schruppzerspannung von C-Stahl, legierten Stählen und Gusseisen</b> Für unterbrochene Schnitte und Entfernung von Zunder. Eine Kombination aus einer breiten Primärfase und einer großen Spankammer ermöglicht hohe Vorschübe.	C-Stahl Leg. Stahl  18° 0.32 mm Ecke 18° 0.32 mm Nebenschneidenprofil CNMG120408-GH
		<b>GJ</b> 	<b>Alternativer Spanbrecher für die Schruppzerspannung von schwer zerspanbaren Werkstoffen</b> Gute Balance zwischen Schneidkantenschärfe und Stabilität. Schneidkante mit hohem Verschleißwiderstand.	Schwer zu bearbeitende Werkstoffe  18° 0.15 mm Ecke 18° 0.15 mm Nebenschneidenprofil CNMG120408-GJ
Schwerzerspannung	M	<b>HX</b> 	<b>Erste Empfehlung für die Schwerzerspannung von allgemeinen und legierten Stahlsorten</b> Deckt den mittleren Schwerzerspanbereich ab. Hohe Schneidkantenstabilität dank einer speziellen Verfassung an der Primärfase. Große Spankammer ermöglicht einfache Spanabfuhr.	C-Stahl Leg. Stahl  23° 0.43 mm Ecke 21° 0.52 mm Nebenschneidenprofil CNMM190616-HX
		<b>HL</b> 	<b>Erste Empfehlung für die Schwerzerspannung von rostfreiem Stahl</b> <b>Alternativer Spanbrecher für die Schwerzerspannung von C-Stahl und legierten Stählen</b> Deckt das untere Ende der Schwerzerspannung ab. Die gebogene Schneidkante und die schmale Fase sorgen für eine optimale Spankontrolle bei gleichzeitiger Schneidkantenschärfe. Punkte auf dem Spitzenradius stellen die Spankontrolle bei geringen Schnitttiefen sicher.	Rostfreier Stahl  15° 0.34 mm
		<b>HR</b> 	<b>Alternativer Spanbrecher für die Schwerzerspannung von allgemeinen und legierten Stahlsorten</b> Deckt den Schwerzerspannungsbereich dank einer geraden Schneidkante mit hoher Stabilität ab. Für eine reibungslose Spankontrolle bei großen Schnitttiefen und hohen Vorschüben.	C-Stahl Leg. Stahl  20° 0.58 mm
		<b>HV</b> 	<b>Alternativer Spanbrecher für die Schwerzerspannung von allgemeinen und legierten Stahlsorten</b> Deckt den oberen Schwerzerspanbereich ab. Breite Primärfase und breite Verfassung sorgen für extrem hohe Schneidkantenstabilität. Breiter Spanbrecher verhindert Spänestau.	C-Stahl Leg. Stahl  20° 0.68 mm Ecke 20° 0.68 mm Nebenschneidenprofil SNMM190616-HV
		<b>HZ</b> 	<b>Alternativer Spanbrecher für die Schwerzerspannung von allgemeinen und legierten Stahlsorten</b> Deckt das untere Ende der Schwerzerspannung ab. Eine positive Primärfase und eine geschwungene Schneidkante reduzieren den Schnittwiderstand. Punkte an der WSP erhöhen die Spankontrolle.	C-Stahl Leg. Stahl  22° 0.42 mm Ecke 6° 0.42 mm Nebenschneidenprofil CNMM190616-HZ
		<b>HM</b> 	<b>Alternativer Spanbrecher für die Schwerzerspannung von C-Stahl, legierten Stählen und rostfreiem Stahl</b> Deckt das untere Ende bis zum mittleren Bereich der Schwerzerspannung ab. Die gebogene Schneidkante und die schmale Fase sorgen für eine optimale Spankontrolle bei gleichzeitiger Schneidkantenschärfe. Tropfenförmige Punkte entlang der Schneidkante stellen die Spankontrolle auch bei wechselnden Schnitttiefen sicher.	C-Stahl Leg. Stahl  16° 0.32 mm
		<b>HXD</b> 	<b>Alternative Spanbrecher für die Schwerzerspannung von Weich- und rostfreiem Stahl</b> Deckt den unteren bis mittleren Schwerzerspanbereich ab. Ausgewogenes Verhältnis von Schärfe und Schneidkantenstabilität durch die schmale Fase und den variablen Schneidrücken.	Allg. Baustahl  25° 0.35 Ecke 30° 0.55 Nebenschneidenprofil SNMM250724

	Rhombus 80° 	Rhombus 55° 	Vierkant 90° 	Dreikant 60° 	Rhombus 35° 	Sechskant 80° 	Rund 	Spanbrecher Bezeichnung und Schnittbild
	<b>CNMG_GH</b>  ↻ A103	<b>DNMG_GH</b>  ↻ A110	<b>SNMG_GH</b>  ↻ A117	<b>TNMG_GH</b>  ↻ A124		<b>WNMG_GH</b>  ↻ A134		<b>GH</b> 
	<b>CNMG_GJ</b>  ↻ A103	<b>DNMG_GJ</b>  ↻ A110				<b>WNMG_GJ</b>  ↻ A134		<b>GJ</b> 
	<b>CNMM_HX</b>  ↻ A103		<b>SNMM_HX</b>  ↻ A117					<b>HX</b> 
	<b>CNMM_HL</b>  ↻ A103	<b>DNMM_HL</b>  ↻ A110	<b>SNMM_HL</b>  ↻ A117	<b>TNMM_HL</b>  ↻ A124				<b>HL</b> 
	<b>CNMM_HR</b>  ↻ A104		<b>SNMM_HR</b>  ↻ A117					<b>HR</b> 
	<b>CNMM_HV</b>  ↻ A104		<b>SNMM_HV</b>  ↻ A117					<b>HV</b> 
	<b>CNMM_HZ</b>  ↻ A104	<b>DNMM_HZ</b>  ↻ A111	<b>SNMM_HZ</b>  ↻ A117	<b>TNMM_HZ</b>  ↻ A124				<b>HZ</b> 
	<b>CNMM_HM</b>  ↻ A104		<b>SNMM_HM</b>  ↻ A117					<b>HM</b> 
			<b>SNMM_HXD</b>  ↻ A118					<b>HXD</b> 

A

WSP DREHEN











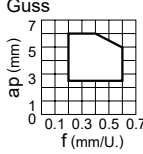

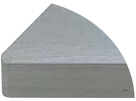
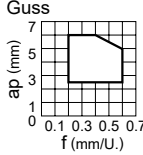









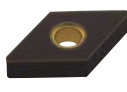

# KLASSIFIZIERUNG

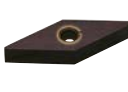
## NEGATIVE WSP MIT LOCH

A

WSP DREHEN

Anwendung	Toleranz	Spanbrecherbezeichnung und Abb.	Eigenschaften	Querschnitt Geometrie
Für Guss	M	<p><b>Glatt</b></p> 	<p><b>Erste Empfehlung für die Schwerzerspanung von Gusseisen</b></p> <p>Effiziente Geometrie mit Fokus auf Schneidkantenstabilität.</p>	<p>Guss</p>   <p>CNMA120408</p>
	G	<p><b>Glatt</b></p> 	<p><b>Für die Schwerzerspanung von Gusseisen</b></p> <p>Effiziente Geometrie mit Fokus auf Schneidkantenstabilität. Für die Bearbeitung von Werkstücken mit hohen Toleranzanforderungen.</p>	<p>Guss</p>   <p>DNGA150408</p>











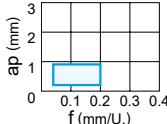

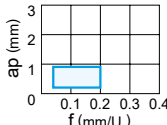

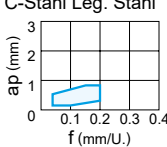

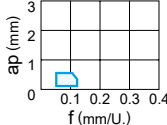
	Rhombus 80° 	Rhombus 55° 	Vierkant 90° 	Dreikant 60° 	Rhombus 35° 	Sechskant 80° 	Rund 	Spanbrecher Bezeichnung und Schnittbild
	<b>CNMA</b>  ↻ A104	<b>DNMA</b>  ↻ A111	<b>SNMA</b>  ↻ A118	<b>TNMA</b>  ↻ A125	<b>VNMA</b>  ↻ A129	<b>WNMA</b>  ↻ A134		<b>Glatt(M)</b> 
		<b>DNGA</b>  ↻ A111	<b>SNGA</b>  ↻ A118	<b>TNGA</b>  ↻ A125	<b>VNGA</b>  ↻ A129			<b>Glatt(G)</b> 

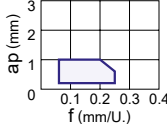

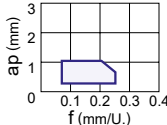

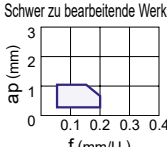

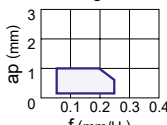

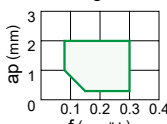

















**A**  
WSP DREHEN

# KLASSIFIZIERUNG

## 5° POSITIVE WENDESCHNEIDPLATTEN MIT LOCH

A  
WSP DREHEN

Anwendung	Toleranz	Spanbrecherbezeichnung und Abb.	Eigenschaften		Querschnitt Geometrie	
Schlichtzerspanung	M	<b>FP</b> 	<b>Erste Wahl für die Schlichtzerspanung von C-Stahl, legiertem Stahl und Baustahl</b> Die Spanbrecherausbuchtung an der Spitze kontrolliert Späne auch bei sehr geringen Schnitttiefen. Schlichtspanbrecher für hohe Oberflächenqualität.	C-Stahl Leg. Stahl 	Ecke 6° Nebenschneidenprofil 6° VBMT110304-FP	
		<b>FM</b> 	<b>Erste Wahl für die Schlichtzerspanung von rostfreiem Stahl</b> Die Spanbrecherausbuchtung an der Spitze kontrolliert Späne selbst bei geringsten Schnitttiefen. Schlichtspanbrecher für hohe Oberflächenqualität.	Rostfreier Stahl 	Ecke 6° Nebenschneidenprofil 6° VBMT110304-FM	
		<b>FV</b> 	<b>Erste Wahl für die Schlichtzerspanung von C-Stahl, legierten Stählen, Baustahl und rostfreiem Stahl</b> Hohe Spankontrolle bei niedrigen Schnitttiefen und Vorschüben. Scharfe Schneidkante ermöglicht einen weichen Schnitt.	C-Stahl Leg. Stahl 	Ecke 18° Nebenschneidenprofil 8° VBMT110304-FV	
	G	<b>R/L-F</b> 	<b>Schlichten</b> Spanleitstufe für leichte Spanabfuhr. Scharfe Schneidkante erzeugt eine gute Oberfläche.	C-Stahl Leg. Stahl 	Nebenschneidenprofil 13° VBGT110304R-F	
	Leichtzerspanung	M	<b>LP</b> 	<b>Erste Empfehlung für die Leichtzerspanung von C-Stahl und legierten Stahlsorten</b> Scharfe Schneidkante durch großen Spanwinkel. Verhindert Spanverschweißung an der WSP und Trübungen an der Werkstückoberfläche. Exzellente Spankontrolle für das Schlichten und Kopierdrehen.	C-Stahl Leg. Stahl 	Ecke 18° Nebenschneidenprofil 8° VBMT110304-LP
			<b>LM</b> 	<b>Erste Empfehlung für die Leichtzerspanung von rostfreiem Stahl</b> Scharfe Schneidkante durch großen Spanwinkel. Deutliche Reduzierung der Gratbildung durch optimierte Schärfeigenschaften und Schneidkantenstärke für verschiedene Spanwinkel. Exzellente Spankontrolle für das Schlichten und Kopierdrehen.	Rostfreier Stahl 	Ecke 18° Nebenschneidenprofil 8° VBMT110304-LM
<b>NEW LS</b> 			<b>Erste Wahl für die leichte Zerspanung von schwer zerspanbaren Werkstoffen</b> Verhindert Aufbauschneidenbildung der WSP und weiße Trübungen der Oberfläche.	Schwer zu bearbeitende Werkstoffe 	Ecke 18° Nebenschneidenprofil 8° VBMT110304-LS	
<b>SV</b> 			<b>Alternativer Spanbrecher für C-Stahl, legierte Stähle und rostfreien Stahl</b> Großer Spanwinkel sorgt für ein scharfes Zerspanen. Der runde Punkt gewährleistet eine gute Spankontrolle bei Schnitttiefen unter 1 mm.	C-Stahl Leg. Stahl 	Ecke 18° Nebenschneidenprofil 8° VBMT110304-SV	
Mittlere Zerspanung	M	<b>MP</b> 	<b>Erste Wahl für die mittlere Zerspanung von C-Stahl, legiertem Stahl und Baustahl</b> Exzellente Balance aus Schärfe und Schneidkantenstabilität. Für einen breiten Anwendungsbereich und multifunktionale Bearbeitung. Hohe Spankontrolle auch bei wechselnden Schnitttiefen.	C-Stahl Leg. Stahl 	Ecke 25° 0.1 mm Nebenschneidenprofil 25° 0.1 mm VBMT160404-MP	











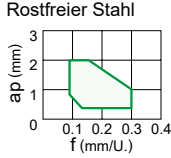
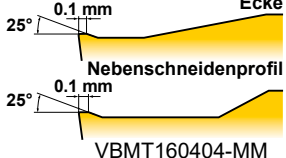

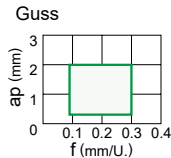
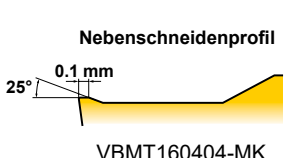

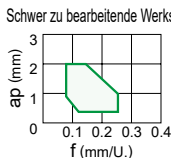
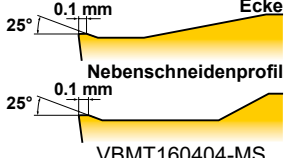

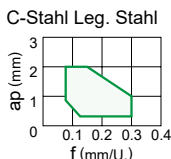
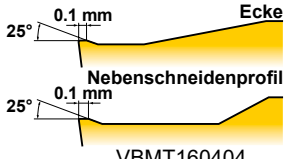
	Rhombus 80° 	Rhombus 55° 	Vierkant 90° 	Dreikant 60° 	Rhombus 35° 	Sechskant 80° 	Rund 	Spanbrecher Bezeichnung und Schnittbild
					<b>VBMT_FP</b>  A164			<b>FP</b> 
					<b>VBMT_FM</b>  A164			<b>FM</b> 
					<b>VBMT_FV</b>  A164			<b>FV</b> 
					<b>VBGT_R/L-F</b>  A164	<b>WBG_T_R/L-F</b>  A172		<b>R/L-F</b> 
					<b>VBMT_LP</b>  A164			<b>LP</b> 
					<b>VBMT_LM</b>  A164			<b>LM</b> 
					<b>VBMT_LS</b> <small>NEW</small>  A165			<small>NEW</small> <b>LS</b> 
					<b>VBMT_SV</b>  A165			<b>SV</b> 
					<b>VBMT_MP</b>  A165			<b>MP</b> 

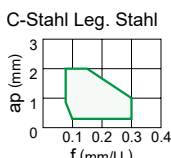
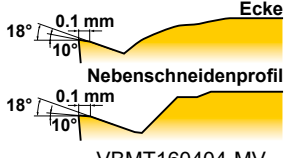

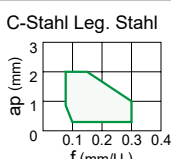
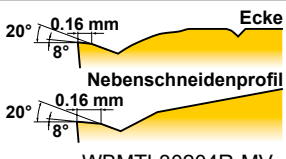

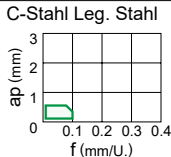
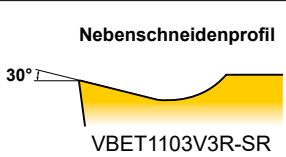

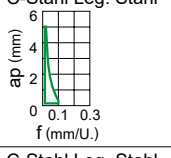
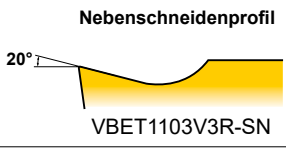
**A**  
WSP DREHEN

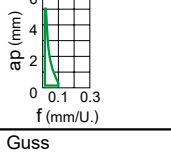
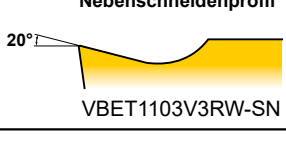
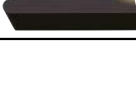
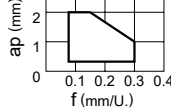
# KLASSIFIZIERUNG

## 5° POSITIVE WENDESCHNEIDPLATTEN MIT LOCH

A  
WSP DREHEN

Anwendung	Toleranz	Spanbrecherbezeichnung und Abb.	Eigenschaften		Querschnitt Geometrie	
Mittlere Zerspanung	M	<b>MM</b> 	<b>Erste Empfehlung für die mittlere Zerspanung von rostfreiem Stahl</b> Gute Ausgewogenheit zwischen Verschleißwiderstand und Bruchwiderstand durch kleine Primärfase. Hoher Widerstand gegen plastische Deformation. Hohe Standzeit in einem breiten Anwendungsbereich.	Rostfreier Stahl 	 25° 0.1 mm Ecke 25° 0.1 mm Nebenschneidenprofil VBMT160404-MM	
		<b>MK</b> 	<b>Erste Empfehlung für die mittlere Zerspanung von Gusseisen</b> Exzellente Balance aus Schärfe und Schneidkantenstabilität. Für einen breiten Anwendungsbereich und multifunktionale Bearbeitung.	Guss 	 25° 0.1 mm Nebenschneidenprofil VBMT160404-MK	
		<b>MS</b> 	<b>Erste Wahl für die mittlere Zerspanung von schwer zerspanbaren Werkstoffen</b> Ideal für hitzebeständige Titanlegierungen und Kobalt-Chromlegierungen. Hoher Widerstand gegen plastische Deformation. Hohe Standzeit in einem breiten Anwendungsbereich.	Schwer zu bearbeitende Werkstoffe 	 25° 0.1 mm Ecke 25° 0.1 mm Nebenschneidenprofil VBMT160404-MS	
		<b>Standard</b> 	<b>Alternativer Spanbrecher für die mittlere Zerspanung von C-Stahl, legierten Stählen und rostfreiem Stahl</b> Gute Balance zwischen Schneidkantenschärfe und Stabilität.	C-Stahl Leg. Stahl 	 25° 0.1 mm Ecke 25° 0.1 mm Nebenschneidenprofil VBMT160404	
		<b>MV</b> 	<b>Alternativer Spanbrecher für die mittlere Zerspanung von C-Stahl, legierten Stählen, Baustahl und rostfreiem Stahl</b> Eine positive Primärfase und eine geschwungene Schneidkante erzeugen einen weichen Schnitt. Die Geometrie bietet eine ausgezeichnete Spanabfuhr.	C-Stahl Leg. Stahl 	 18° 0.1 mm Ecke 10° 18° 0.1 mm 10° Nebenschneidenprofil VBMT160404-MV	
		<b>R/L-MV</b> 	<b>Alternativer Spanbrecher für die mittlere Zerspanung von C-Stahl, legierten Stählen, Baustahl und rostfreiem Stahl</b> Eine positive Primärfase und eine geschwungene Schneidkante erzeugen einen weichen Schnitt. Die Geometrie bietet eine ausgezeichnete Spanabfuhr.	C-Stahl Leg. Stahl 	 20° 0.16 mm Ecke 8° 20° 0.16 mm 8° Nebenschneidenprofil WBMTL30204R-MV	
		E	<b>R/L-SR</b> 	<b>Für die mittlere Zerspanung auf Langdrehautomaten</b> Spanbrecher mit großer Primärfase. Spezielles Design für geringen Schnittwiderstand und hohe Spankontrolle.	C-Stahl Leg. Stahl 	 30° Nebenschneidenprofil VBET1103V3R-SR
			<b>R/L-SN</b> 	<b>Für die mittlere Zerspanung auf Langdrehautomaten</b> Parallele Spanleitstufe. Hohe Spankontrolle bei kleinen bis mittleren Vorschüben.	C-Stahl Leg. Stahl 	 20° Nebenschneidenprofil VBET1103V3R-SN
			<b>R/LW-SN</b> 	<b>Für die mittlere Zerspanung auf Langdrehautomaten</b> Parallel Spanbrecher. Hohe Spankontrolle bei kleinen bis mittleren Vorschüben. Wiper Geometrie, ermöglicht doppelte Vorschübe bei gleicher Oberflächengüte.	C-Stahl Leg. Stahl 	 20° Nebenschneidenprofil VBET1103V3RW-SN
		Für Guss	M	<b>Glatt</b> 	<b>Erste Wahl für die Schwerzerspanung von Gusseisen</b> Doppelseitige, glatte Geometrie. Effiziente Geometrie, dank der hohen Schneidkantenstabilität.	Guss 

	Rhombus 80° 	Rhombus 55° 	Vierkant 90° 	Dreikant 60° 	Rhombus 35° 	Sechskant 80° 	Rund 	Spanbrecher Bezeichnung und Schnittbild
					<b>VBMT_MM</b>  A165			<b>MM</b> 
					<b>VBMT_MK</b>  A165			<b>MK</b> 
					<b>VBMT_MS</b>  A165			<b>MS</b> 
					<b>VBMT</b>  A165			<b>Standard</b> 
					<b>VBMT_MV</b>  A165			<b>MV</b> 
						<b>WBMT_R/L-MV</b>  A172		<b>R/L-MV</b> 
					<b>VBET_R/L-SR</b>  A166			<b>R/L-SR</b> 
					<b>VBET_R/L-SN</b>  A166			<b>R/L-SN</b> 
					<b>VBET_R/LW-SN</b>  A166			<b>R/LW-SN</b> 
					<b>VBMW</b>  A166			<b>Glatt</b> 









A

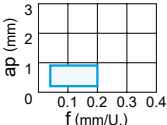
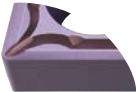
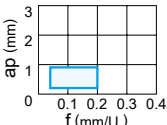
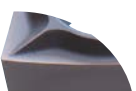
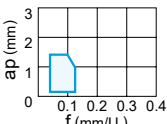

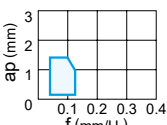
WSP DREHEN

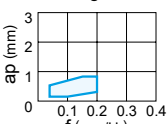
# KLASSIFIZIERUNG

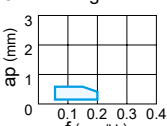
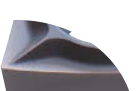
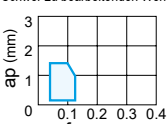
## 7° POSITIVE WENDESCHNEIDPLATTEN MIT LOCH

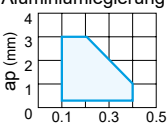
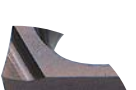
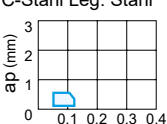
A  
WSP DREHEN

Anwendung	Toleranz	Spanbrecherbezeichnung und Abb.	Eigenschaften		Querschnitt Geometrie
Schlichtzerspanung	M	<b>FP</b> 	<b>Erste Wahl für die Schlichtzerspannung von C-Stahl, legiertem Stahl und Baustahl</b> Die Spanbrecherausbuchtung an der Spitze kontrolliert Späne auch bei sehr geringen Schnitttiefen. Schlichtspanbrecher für hohe Oberflächenqualität.	C-Stahl Leg. Stahl 	Ecke 6° Nebenschneidenprofil CCMT09T304-FP
		<b>FM</b> 	<b>Erste Wahl für die Schlichtzerspannung von rostfreiem Stahl</b> Die Spanbrecherausbuchtung an der Spitze kontrolliert Späne auch bei sehr geringen Schnitttiefen. Schlichtspanbrecher für hohe Oberflächenqualität.	Rostfreier Stahl 	Ecke 6° Nebenschneidenprofil CCMT09T304-FM
	G	<b>FS</b> 	<b>Erste Wahl für die Schlichtzerspannung von schwer zerspanbaren Werkstoffen</b> Ideal für hitzebeständige Materialien, Titanlegierungen und Kobalt-Chromlegierungen. Scharfe Schneidkanten sorgen für exzellente Maßhaltigkeit. Hocheffiziente Spanabfuhr dank geschwungener Schneidkanten.	Schwer zu bearbeitenden Werkstoffen 	Ecke 14° Nebenschneidenprofil 9° CCGT09T302M-FS
		<b>FS-P</b> 	<b>Erste Wahl für die Schlichtzerspannung von Titanlegierungen</b> Ideal für Titan- und Kupferlegierungen. Scharfe Schneidkanten sorgen für exzellente Maßhaltigkeit. Hocheffiziente Spanabfuhr dank geschwungener Schneidkanten. Polierte (Hochglanz-)Oberflächen der WSP vermeiden die Aufbauschneidenbildung enorm und verlängern die Werkzeugstandzeit.	Titanlegierungen 	Ecke 14° Nebenschneidenprofil 9° CCGT09T302M-FS-P
	M	<b>FV</b> 	<b>Alternativer Spanbrecher für die Schlichtzerspannung von C-Stahl, legierten Stählen, Baustahl und rostfreiem Stahl</b> Hohe Spankontrolle bei niedrigen Schnitttiefen und Vorschüben. Scharfe Schneidkante ermöglicht einen weichen Schnitt.	C-Stahl Leg. Stahl 	Ecke 18° Nebenschneidenprofil 8° CCMT09T304-FV
		<b>SVX</b> 	<b>Alternativer Spanbrecher für die Leichtzerspannung von allgemeinen und legierten Stahlsorten</b> Bessere Spankontrolle durch eine Spanbrechergeometrie, die für das Kopieren geeignet ist.	C-Stahl Leg. Stahl 	Ecke 18° Nebenschneidenprofil 8° XCMT150304-SVX
	G	<b>FJ</b> 	<b>Alternativer Spanbrecher für die Leichtzerspannung von allgemeinen und legierten Stahlsorten</b> Für das Schlichten von warmfesten und Nickelbasislegierungen. Scharfe Schneidkante sorgt für eine gute Oberflächengüte. Geschwungene Schneidkante ermöglicht einen weichen Schnitt.	Schwer zu bearbeitenden Werkstoffen 	Ecke 14° Nebenschneidenprofil 9° CCGT09T302-FJ
		<b>AZ</b> 	<b>Für das Zerspanen von Aluminiumlegierungen</b> Positive WSP mit polierter Oberfläche für die Bearbeitung von NE-Werkstoffe. Ideal für die Zerspannung von Aluminium-Werkstoffen. Hohe Schneidkantenschärfe und Spankontrolle.	Aluminiumlegierung 	Nebenschneidenprofil 30° DCGT11T304-AZ
		<b>R/L-F</b> 	<b>Schlichten</b> Spanleitstufe für leichte Spanabfuhr. Scharfe Schneidkante erzeugt eine gute Oberfläche.	C-Stahl Leg. Stahl 	Nebenschneidenprofil 17° CCGT03S102L-F

	Rhombus 80° 	Rhombus 55° 	Vierkant 90° 	Dreikant 60° 	Rhombus 35° 	Sechskant 80° 	Rhombus 25° 	Rund 	Spanbrecher Bezeichnung und Schnittbild
	CCMT_FP  ↻ A139	DCMT_FP  ↻ A147	SCMT_FP  ↻ A155	TCMT_FP  ↻ A158	VCMT_FP  ↻ A167				FP 
	CCMT_FM  ↻ A139	DCMT_FM  ↻ A147	SCMT_FM  ↻ A155	TCMT_FM  ↻ A158	VCMT_FM  ↻ A167				FM 
	CCGT_FS  ↻ A139	DCGT_FS  ↻ A147							FS 
	CCGT_FS-P  ↻ A139	DCGT_FS-P  ↻ A147							FS-P 
	CCMT_FV  ↻ A139	DCMT_FV  ↻ A147	SCMT_FV  ↻ A155	TCMT_FV  ↻ A158	VCMT_FV  ↻ A167				FV 
							XCMT_SVX  ↻ A175		SVX 
	CCGT_FJ  ↻ A139								FJ 
	CCGT_AZ  ↻ A140	DCGT_AZ  ↻ A147		TCGT_AZ  ↻ A158	VCGT_AZ  ↻ A167			RCGT_AZ  ↻ A154	AZ 
	CCGT_L-F CCGH_R/L-F  ↻ A140	DCGT_R/L-F  ↻ A148		TCGT_R/L-F  ↻ A158	VCGT_R/L-F  ↻ A167				R/L-F 

A











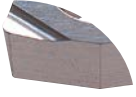
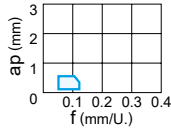
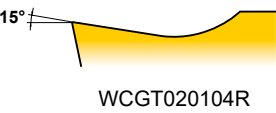
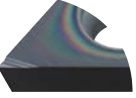
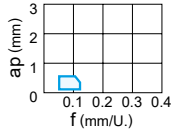
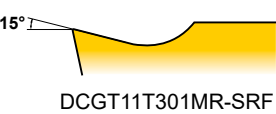

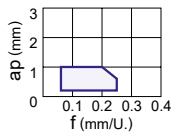
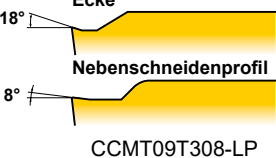

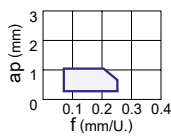
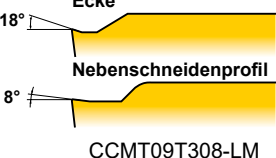
WSP DREHEN

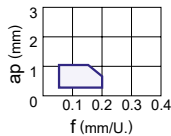
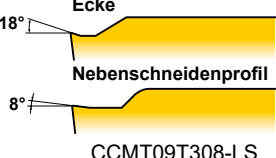

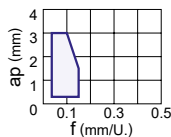
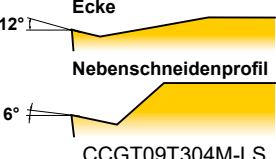

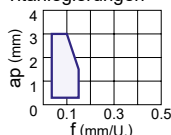

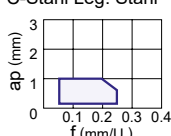

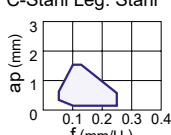
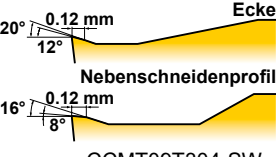



































# KLASSIFIZIERUNG

## 7° POSITIVE WENDESCHNEIDPLATTEN MIT LOCH

A  
WSP DREHEN

Anwendung	Toleranz	Spanbrecherbezeichnung und Abb.	Eigenschaften		Querschnitt Geometrie
Schlichtzerspanung	G	<b>R/L</b> 	<b>Schlichten</b> Große Spankammer. Hohe Spankontrolle bei niedrigen Vorschüben.	C-Stahl Leg. Stahl 	<b>Nebenschneidenprofil</b> 15°  WCGT020104R
		<b>NEW R-SRF</b> 	<b>Schlichten</b> Der primäre Spanbrecher steuert die Spanabfuhr. Die scharfe Schneidkante sorgt für eine ausgezeichnete Oberflächenbeschaffenheit.	C-Stahl Leg. Stahl • Rostfreier Stahl • Schwer zu bearbeitende Werkstoffe 	<b>Nebenschneidenprofil</b> 15°  DCGT11T301MR-SRF
Leichtzerspanung	M	<b>LP</b> 	<b>Erste Empfehlung für die leichte Zerspanung von C-Stahl, legiertem Stahl und Baustahl</b> Scharfe Schneidkante durch großen Spanwinkel. Verhindert Spanverschweißung an der WSP und Trübungen an der Werkstückoberfläche. Exzellente Spankontrolle für das Schlichten und Kopierdrehen.	C-Stahl Leg. Stahl 	<b>Ecke</b> 18° <b>Nebenschneidenprofil</b> 8°  CCMT09T308-LP
		<b>LM</b> 	<b>Erste Empfehlung für die Leichtzerspanung von rostfreiem Stahl</b> Scharfe Schneidkante durch großen Spanwinkel. Deutliche Reduzierung der Gratbildung durch optimierte Schärfeeigenschaften und Schneidkantenstärke für verschiedene Spanwinkel. Exzellente Spankontrolle für das Schlichten und Kopierdrehen.	Rostfreier Stahl 	<b>Ecke</b> 18° <b>Nebenschneidenprofil</b> 8°  CCMT09T308-LM
		<b>LS</b> 	<b>Erste Empfehlung für die Leichtzerspanung von schwer zu bearbeitenden Werkstoffen</b> Verhindert Aufbauschneidenbildung der WSP und Trübungen der Oberflächenbeschaffenheit.	Schwer zu bearbeitende Werkstoffe 	<b>Ecke</b> 18° <b>Nebenschneidenprofil</b> 8°  CCMT09T308-LS
	G	<b>LS</b> 	<b>Erste Empfehlung für die Leichtzerspanung von schwer zu bearbeitenden Werkstoffen</b> Ideal für hitzebeständige Legierungen, Titanlegierungen und Kobalt-Chrom-Legierungen. Ausgestattet mit parallelen Schneidkanten. Ermöglicht stabile Spankontrolle über ein breites Spektrum, von geringen bis mittleren Schnitttiefen.	Schwer zu bearbeitende Werkstoffe 	<b>Ecke</b> 12° <b>Nebenschneidenprofil</b> 6°  CCGT09T304M-LS
		<b>LS-P</b> 	<b>Erste Wahl für die leichte Zerspanung von Titanlegierungen</b> Ideal für Titan- und Kupferlegierungen. Ausgestattet mit parallelen Schneidkanten. Ermöglicht stabile Spankontrolle über ein breites Spektrum, von geringen bis mittleren Schnitttiefen. Polierte (Hochglanz-)Oberflächen der WSP verhindern die Aufbauschneidenbildung enorm und verlängern die Werkzeugstandzeit.	Titanlegierungen 	<b>Ecke</b> 12° <b>Nebenschneidenprofil</b> 6°  CCGT09T304M-LS-P
		M	<b>SV</b> 	<b>Alternativer Spanbrecher für die Leichtzerspanung von C-Stahl, legierten, Baustahl und rostfreien Stahlsorten</b> Scharfe Schneidkante ermöglicht einen weichen Schnitt. Hohe Spankontrolle auch bei Schnitttiefen unter 1mm.	C-Stahl Leg. Stahl 
<b>SW</b> 	<b>Wiper-WSP für die Leichtzerspanung von C-Stahl, legierten, Baustahl und rostfreien Stahlsorten</b> Wiper Geometrie, ermöglicht doppelte Vorschübe bei gleicher Oberflächengüte. Positive Primärfase ermöglicht einen weichen Schnitt.		C-Stahl Leg. Stahl 	<b>Ecke</b> 20° 12° <b>Nebenschneidenprofil</b> 16° 8° 0.12 mm 0.12 mm  CCMT09T304-SW	

	Rhombus 80° 	Rhombus 55° 	Vierkant 90° 	Dreikant 60° 	Rhombus 35° 	Sechskant 80° 	Rund 	Spanbrecher Bezeichnung und Schnittbild
						WCGT_R/L  ↻ A173		R/L 
		DCGT_R-SRF <small>NEW</small>  ↻ A148						<small>NEW</small> R-SRF 
	CCMT_LP  ↻ A141	DCMT_LP  ↻ A148	SCMT_LP  ↻ A155	TCMT_LP  ↻ A159	VCMT_LP  ↻ A167			LP 
	CCMT_LM  ↻ A141	DCMT_LM  ↻ A148	SCMT_LM  ↻ A155	TCMT_LM  ↻ A159	VCMT_LM  ↻ A167			LM 
	CCMT_LS  ↻ A141	DCMT_LS  ↻ A148		<small>NEW</small> TCMT_LS  ↻ A159	VCMT_LS  ↻ A168			LS(M) 
	CCGT_LS  ↻ A141	DCGT_LS  ↻ A148			VCGT_LS  ↻ A168			LS(G) 
	CCGT_LS-P  ↻ A141	DCGT_LS-P  ↻ A149			VCGT_LS-P  ↻ A168			LS-P 
	CCMH_SV  ↻ A141	DCMT_SV  ↻ A149			VCMT_SV  ↻ A168			SV 
	CCMT_SW  ↻ A141							SW 











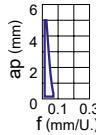
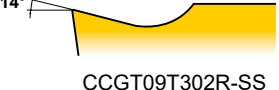

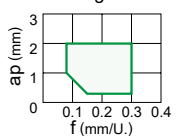
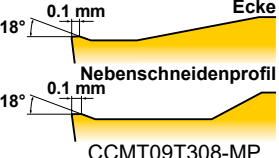

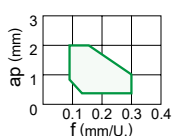
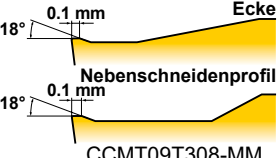
A

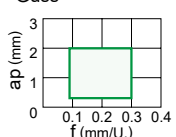
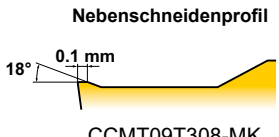

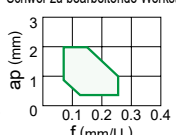
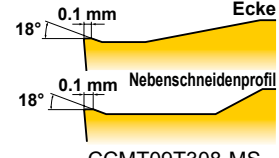

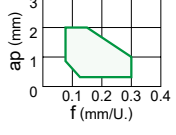
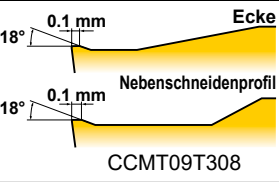
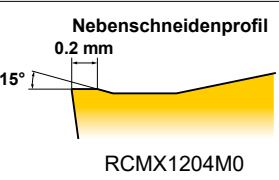
WSP DREHEN

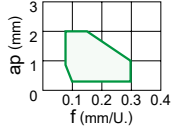
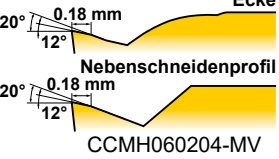
# KLASSIFIZIERUNG

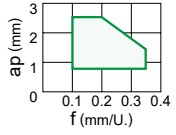
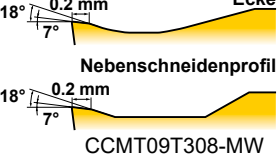
## 7° POSITIVE WENDESCHNEIDPLATTEN MIT LOCH

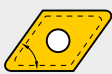
WSP DREHEN

Anwendung	Toleranz	Spanbrecherbezeichnung und Abb.	Eigenschaften		Querschnitt Geometrie
Leichtzerspannung	G	<b>R/L-SS</b> 	<b>Spanbrecher für die leichte Zerspanung auf Langdrehautomaten</b> Parallele Spanleitstufe. Hohe Spankontrolle bei niedrigen Vorschüben.	C-Stahl Leg. Stahl 	Nebenschneidenprofil  CCGT09T302R-SS
		<b>MP</b> 	<b>Erste Empfehlung für die mittlere Zerspanung von C-Stahl, legiertem Stahl und Baustahl</b> Exzellente Balance aus Schärfe und Schneidkantenstabilität. Für einen breiten Anwendungsbereich und multifunktionale Bearbeitung. Hohe Spankontrolle auch bei wechselnden Schnitttiefen.	C-Stahl Leg. Stahl 	18° Ecke 0.1 mm Nebenschneidenprofil 18° 0.1 mm  CCMT09T308-MP
Mittlere Zerspannung	M	<b>MM</b> 	<b>Erste Empfehlung für die mittlere Zerspanung von rostfreiem Stahl</b> Gute Ausgewogenheit zwischen Verschleißwiderstand und Bruchwiderstand durch kleine Primärfase. Hoher Widerstand gegen plastische Deformation. Hohe Standzeit in einem breiten Anwendungsbereich.	Rostfreier Stahl 	18° Ecke 0.1 mm Nebenschneidenprofil 18° 0.1 mm  CCMT09T308-MM
		<b>MK</b> 	<b>Erste Empfehlung für die mittlere Zerspanung von Gusseisen</b> Exzellente Balance aus Schärfe und Schneidkantenstabilität. Für einen breiten Anwendungsbereich und multifunktionale Bearbeitung.	Guss 	Nebenschneidenprofil 18° 0.1 mm  CCMT09T308-MK
		<b>MS</b> 	<b>Erste Empfehlung für die mittlere Zerspanung von schwer zerspanbaren Werkstoffen</b> Ideal für hitzebeständige Legierungen, Titanlegierungen und Kobalt-Chromlegierungen. Für einen breiten Anwendungsbereich und multifunktionale Bearbeitung. Hohe Spankontrolle auch bei wechselnden Schnitttiefen.	Schwer zu bearbeitende Werkstoffe 	18° Ecke 0.1 mm Nebenschneidenprofil 18° 0.1 mm  CCMT09T308-MS
		<b>Standard</b> 	<b>Alternativer Spanbrecher für die mittlere Zerspanung von C-Stahl, legierten Stählen, Baustahl, rostfreiem Stahl und Gusseisen</b> Gute Balance zwischen Schneidkantenschärfe und Stabilität.	C-Stahl Leg. Stahl 	18° Ecke 0.1 mm Nebenschneidenprofil 18° 0.1 mm  CCMT09T308 15° Ecke 0.2 mm Nebenschneidenprofil  RCMX1204M0
		<b>MV</b> 	<b>Alternativer Spanbrecher für die mittlere Zerspanung von C-Stahl, legierten, Baustahl und rostfreien Stahlsorten</b> Eine positive Primärfase und eine geschwungene Schneidkante erzeugen einen weichen Schnitt. Die Geometrie bietet eine ausgezeichnete Spanabfuhr.	C-Stahl Leg. Stahl 	20° Ecke 12° 0.18 mm Nebenschneidenprofil 20° 0.18 mm 12°  CCMH060204-MV
		<b>MW</b> 	<b>Wiper-WSP für die mittlere Zerspanung von C-Stahl, legierten, Baustahl und rostfreien Stahlsorten</b> Wiper Geometrie, ermöglicht doppelte Vorschübe bei gleicher Oberflächengüte. Große Spankammer ermöglicht einfache Spanabfuhr.	C-Stahl Leg. Stahl 	18° Ecke 7° 0.2 mm Nebenschneidenprofil 18° 0.2 mm 7°  CCMT09T308-MW

	Rhombus 80° 	Rhombus 55° 	Vierkant 90° 	Dreikant 60° 	Rhombus 35° 	Sechskant 80° 	Rund 	Spanbrecher Bezeichnung und Schnittbild
	CCGT_R/L-SS  ↻ A142	DCGT_R/L-SS  ↻ A149						R/L-SS 
	CCMT_MP  ↻ A142	DCMT_MP  ↻ A149	SCMT_MP  ↻ A155	TCMT_MP  ↻ A159	VCMT_MP  ↻ A168			MP 
	CCMT_MM  ↻ A142	DCMT_MM  ↻ A149	SCMT_MM  ↻ A155	TCMT_MM  ↻ A159	VCMT_MM  ↻ A168			MM 
	CCMT_MK  ↻ A143	DCMT_MK  ↻ A150	SCMT_MK  ↻ A156	TCMT_MK  ↻ A159	VCMT_MK  ↻ A169			MK 
	CCMT_MS  ↻ A143	DCMT_MS  ↻ A150	<small>NEW</small> SCMT_MS  ↻ A156	<small>NEW</small> TCMT_MS  ↻ A159	VCMT_MS  ↻ A169			MS 
	CCMT  ↻ A143	DCMT  ↻ A150	SCMT  ↻ A156	TCMT  ↻ A160	VCMT  ↻ A169	WCMT  ↻ A173	RCMT  ↻ A154	Standard 
							RCMX  ↻ A154	
	CCMH_MV  ↻ A143	DCMT_MV  ↻ A150			VCMT_MV  ↻ A169			MV 
	CCMT_MW  ↻ A143							MW 

A











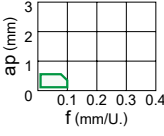
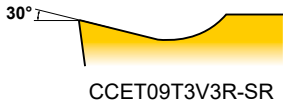

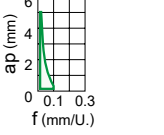
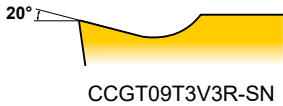
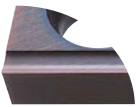
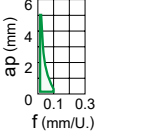
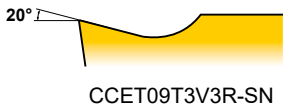
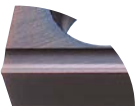
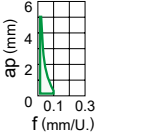
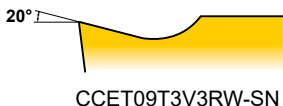
WSP DREHEN

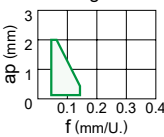

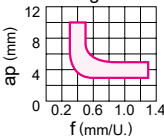
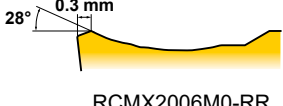

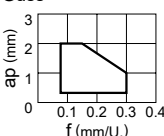

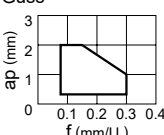



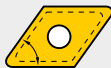





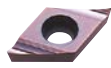











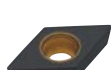

# KLASSIFIZIERUNG

## 7° POSITIVE WENDESCHNEIDPLATTEN MIT LOCH

WSP DREHEN

A

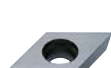
Anwendung	Toleranz	Spanbrecherbezeichnung und Abb.	Eigenschaften		Querschnitt Geometrie
Mittlere Zerspanung	E	<b>R/L-SR</b> 	<b>Für die mittlere Zerspanung auf Langdrehautomaten</b> Spanbrecher mit großer Primärfase. Spezielles Design für geringen Schnittwiderstand und hohe Spankontrolle.	C-Stahl Leg. Stahl 	<b>Nebenschneidenprofil</b> 30°  CCET09T3V3R-SR
	G	<b>R/L-SN</b> 	<b>Für die mittlere Zerspanung auf Langdrehautomaten</b> Parallele Spanleitstufe. Hohe Spankontrolle bei kleinen bis mittleren Vorschüben.	C-Stahl Leg. Stahl 	<b>Nebenschneidenprofil</b> 20°  CCGT09T3V3R-SN
	E	<b>R/L-SN</b> 	<b>Für die mittlere Zerspanung auf Langdrehautomaten</b> Parallele Spanleitstufe. Hohe Spankontrolle bei kleinen bis mittleren Vorschüben. Die Geometrie bietet eine ausgezeichnete Spanabfuhr.	C-Stahl Leg. Stahl 	<b>Nebenschneidenprofil</b> 20°  CCET09T3V3R-SN
	E	<b>R/LW-SN</b> 	<b>Für die mittlere Zerspanung auf Langdrehautomaten</b> Parallele Spanleitstufe. Hohe Spankontrolle bei kleinen bis mittleren Vorschüben. Wiper Geometrie, ermöglicht doppelte Vorschübe bei gleicher Oberflächengüte.	C-Stahl Leg. Stahl 	<b>Nebenschneidenprofil</b> 20°  CCET09T3V3RW-SN
	G	<b>SMG</b> 	<b>Für die mittlere Zerspanung auf Langdrehautomaten</b> Die Geometrie bietet eine ausgezeichnete Spankontrolle. Eine scharfe und hoch präzise Schneidkante ermöglicht hohe Präzision und einen weichen Schnitt. Geometrie ermöglicht Kopierdrehen und Hinterdrehen.	C-Stahl Leg. Stahl 	<b>Ecke</b> 14° <b>Nebenschneidenprofil</b> 9°  CCGT09T304M-SMG
Schwerzerspanung	M	<b>RR</b> 	<b>Für die Schwerzerspanung von C-Stahl und legierten Stahlsorten</b> Breite Primärfase sorgt für hohe Schneidkantenstabilität. Hohe Spankontrolle auch bei geringen Schnitttiefen.	C-Stahl Leg. Stahl 	<b>28°</b> 0.3 mm  RCMX2006M0-RR
Für Guss	M	<b>Glatt</b> 	<b>Erste Empfehlung für die Schwerzerspanung von Gusseisen</b> Doppelseitige, glatte Geometrie. Effiziente Geometrie, dank der hohen Schneidkantenstabilität.	Guss 	0°  CCMW09T308
	G	<b>Glatt</b> 	<b>Spanbrecher für die Schwerzerspanung von Gusseisen</b> Glatte Geometrie. Effiziente Geometrie dank der hohen Schneidkantenstabilität. Für Werkstücke mit hohen Toleranzanforderungen.	Guss 	0°  CCGW09T300

	Rhombus 80° 	Rhombus 55° 	Vierkant 90° 	Dreikant 60° 	Rhombus 35° 	Sechskant 80° 	Rund 	Spanbrecher Bezeichnung und Schnittbild
	CCET_R/L-SR  ↻ A143	DCET_R/L-SR  ↻ A150						R/L-SR 
	CCGT_R/L-SN  ↻ A144	DCGT_R/L-SN  ↻ A151						R/L-SN(G) 
	CCET_R/L-SN  ↻ A145	DCET_R/L-SN  ↻ A151						R/L-SN(E) 
	CCET_R/LW-SN  ↻ A145	DCET_R/LW-SN  ↻ A152						R/LW-SN 
	CCGT_SMG  ↻ A145	DCGT_SMG  ↻ A152						SMG 
							RCMX_RR  ↻ A154	RR 
	CCMW  ↻ A145	DCMW  ↻ A152	SCMW  ↻ A156	TCMW  ↻ A160	VCMW  ↻ A169			Glatt(M) 
	CCGW  ↻ A145	DCGW  ↻ A152						Glatt(G) 

A







WSP DREHEN

# KLASSIFIZIERUNG

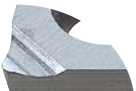
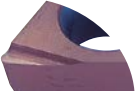



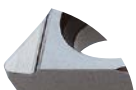





## 11° POSITIVE WENDESCHNEIDPLATTEN MIT LOCH

WSP DREHEN

A

Anwendung	Toleranz	Spanbrecherbezeichnung und Abb.	Eigenschaften	Querschnitt Geometrie	
Schlichtzerspanung	M	<b>FV</b> 	<b>Erste Wahl für die Schlichtzerspanung von C-Stahl, legierten Stählen, Baustahl und rostfreiem Stahl</b> Hohe Spankontrolle bei niedrigen Schnitttiefen und Vorschüben. Scharfe Schneidkante ermöglicht einen weichen Schnitt.	C-Stahl Leg. Stahl  18° Ecke Nebenschneidenprofil CPMH090304-FV	
		<b>Standard</b> 	<b>Schlichten</b> Spanleitstufe für leichte Spanabfuhr. Hohe Spankontrolle bei niedrigen bis mittleren Vorschüben.	Aluminiumlegierung  25° Nebenschneidenprofil CPGT090304	
		<b>R/L-FS</b> 	<b>Spanbrecher für die Schlichtzerspanung von C-Stahl, legierten Stählen, Gusseisen und Aluminiumlegierungen</b> Spanleitstufe für leichte Spanabfuhr. Scharfe Schneidkante erzeugt eine gute Oberfläche.	C-Stahl Leg. Stahl  15° Nebenschneidenprofil TPGH090204R-FS	
	G	M	<b>R/L-F</b> 	<b>Schlichten</b> Spanleitstufe für leichte Spanabfuhr. Scharfe Schneidkante erzeugt eine gute Oberfläche.	C-Stahl Leg. Stahl  15° Nebenschneidenprofil CPMH090304R-F
			<b>R/L-F</b> 	<b>Schlichten</b> Spanleitstufe für leichte Spanabfuhr. Scharfe Schneidkante erzeugt eine gute Oberfläche.	C-Stahl Leg. Stahl  15° Nebenschneidenprofil CPGT090304R-F
		G	<b>R/L</b> 	<b>Schlichten</b> Spanleitstufe für leichte Spanabfuhr. Hohe Spankontrolle bei niedrigen bis mittleren Vorschüben.	C-Stahl Leg. Stahl  10° Nebenschneidenprofil TPGX090204R
			<b>L</b> 	<b>Schlichten</b> Spanleitstufe für leichte Spanabfuhr. Hohe Spankontrolle bei niedrigen bis mittleren Vorschüben.	C-Stahl Leg. Stahl  10° Nebenschneidenprofil TPMX090204L
	E	<b>SRF</b> 	<b>Schlichten</b> Spanleitstufe für leichte Spanabfuhr. Scharfe Schneidkante erzeugt eine gute Oberfläche.	C-Stahl Leg. Stahl  15° Nebenschneidenprofil VPET080201R-SRF	
	Leichtzerspanung	M	<b>SV</b> 	<b>Erste Empfehlung für die leichte Zerspanung von C-Stahl, legiertem Stahl, rostfreien Stahlsorten und Gusseisen</b> Scharfe Schneidkante ermöglicht einen weichen Schnitt. Hohe Spankontrolle auch bei Schnitttiefen unter 1mm.	C-Stahl Leg. Stahl  18° Ecke Nebenschneidenprofil CPMH090304-SV



	Rhombus 80° 	Rhombus 55° 	Vierkant 90° 	Dreikant 60° 	Rhombus 35° 	Sechskant 80° 	Rund 	Spanbrecher Bezeichnung und Schnittbild
	CPMH_FV  → A146			TPMH_FV  → A162				FV 
	CPGT  → A146							Standard 
				TPGH_R/L-FS  → A162		WPGT_R/L-FS  → A174		R/L-FS 
	CPMH_R/L-F  → A146							R/L-F(M) 
	CPGT_R/L-F  → A146							R/L-F(G) 
				TPGX_R/L  → A162				R/L 
				TPMX_L  → A163				L 
					VPET_R/L-SRF  → A171			SRF 
	CPMH_SV  → A146			TPMH_SV  → A163				SV 

A









WSP DREHEN

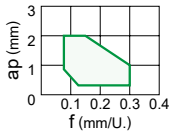

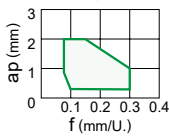
# KLASSIFIZIERUNG

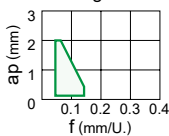

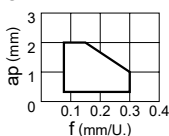

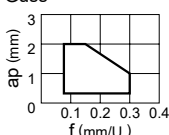



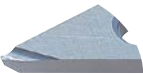
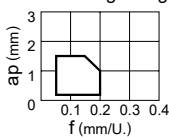

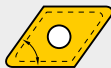









## 11° POSITIVE WENDESCHNEIDPLATTEN MIT LOCH









A  
WSP DREHEN

Anwendung	Toleranz	Spanbrecherbezeichnung und Abb.	Eigenschaften	Querschnitt Geometrie
Mittlere Zerspanung	M	<p><b>Standard</b></p> 	<p><b>Alternativer Spanbrecher für die mittlere Zerspanung von C-Stahl, legiertem Stahl und rostfreien Stahlsorten</b></p> <p>Geometrie für die allgemeine Drehbearbeitung.</p>	<p>C-Stahl Leg. Stahl</p>  <p>Ecke 10° Nebenschneidenprofil CPMX090304</p>
	M	<p><b>MV</b></p> 	<p><b>Erste Empfehlung für die mittlere Zerspanung von C-Stahl, legiertem Stahl, rostfreien Stahlsorten und Gusseisen</b></p> <p>Eine positive Primärfase und eine geschwungene Schneidkante erzeugen einen weichen Schnitt. Gute Balance zwischen Schneidkantenschärfe und Stabilität.</p>	<p>C-Stahl Leg. Stahl</p>  <p>Ecke 20° 0.2 mm 8° Nebenschneidenprofil CPMH090304-MV</p>
	G	<p><b>SMG</b></p> 	<p><b>Für die mittlere Zerspanung auf Langdrehautomaten</b></p> <p>Die Geometrie bietet eine ausgezeichnete Spanabfuhr. Eine scharfe und hochpräzise Schneidkante ermöglicht hohe Präzision und einen weichen Schnitt. Geometrie ermöglicht Kopierdrehen und Hinterdrehen.</p>	<p>C-Stahl Leg. Stahl</p>  <p>Ecke 11° Nebenschneidenprofil VPGT110301M-SMG</p>
Für Guss	M	<p><b>Glatt</b></p> 	<p><b>Erste Empfehlung für die Schwerzerspanung von Gusseisen</b></p> <p>Effiziente Geometrie dank der hohen Schneidkantenstabilität.</p>	<p>Guss</p>  <p>0° SPMW120308</p>
	G	<p><b>Glatt</b></p> 	<p><b>Spanbrecher für die Schwerzerspanung von Gusseisen</b></p> <p>Effiziente Geometrie dank der hohen Schneidkantenstabilität. Für Werkstücke mit hohen Toleranzanforderungen.</p>	<p>Guss</p>  <p>0° SPGX120308</p>

## 15° POSITIVE WENDESCHNEIDPLATTEN MIT LOCH

Anwendung	Toleranz	Spanbrecherbezeichnung und Abb.	Eigenschaften	Querschnitt Geometrie
Für Aluminiumlegierung	G	<p><b>R/L</b></p> 	<p><b>Für die Zerspanung von Aluminiumlegierungen</b></p> <p>Große Spankammer. Scharfe Schneidkante erzeugt eine gute Oberfläche.</p>	<p>Aluminiumlegierung</p>  <p>Nebenschneidenprofil 25° VDGX160302R</p>

	Rhombus 80° 	Rhombus 55° 	Vierkant 90° 	Dreikant 60° 	Rhombus 35° 	Sechskant 80° 	Rund 	Spanbrecher Bezeichnung und Schnittbild
	<b>CPMX</b>  ↻ A146		<b>SPMT</b>  ↻ A157	<b>TPMX</b>  ↻ A163				<b>Standard</b> 
	<b>CPMH_MV</b>  ↻ A146			<b>TPMH_MV</b>  ↻ A163		<b>WPMT_MV</b>  ↻ A174		<b>MV</b> 
					<b>VPGT_SMG</b>  ↻ A171			<b>SMG</b> 
			<b>SPMW</b>  ↻ A157					<b>Glatt(M)</b> 
			<b>SPGX</b>  ↻ A157	<b>TPGX</b>  ↻ A163				<b>Glatt(G)</b> 

	Rhombus 80° 	Rhombus 55° 	Vierkant 90° 	Dreikant 60° 	Rhombus 35° 	Sechskant 80° 	Rund 	Spanbrecher Bezeichnung und Schnittbild
					<b>VDGX_R/L</b>  ↻ A170			<b>R/L</b> 





# KLASSIFIZIERUNG

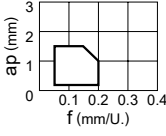
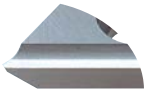
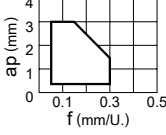



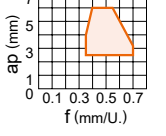

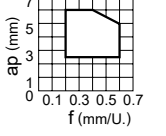

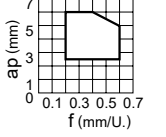

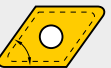
## 20° POSITIVE WENDESCHNEIDPLATTEN MIT LOCH

A  
WSP DREHEN

Anwendung	Toleranz	Spanbrecherbezeichnung und Abb.	Eigenschaften	Querschnitt Geometrie	
Für Aluminiumlegierung	G	<b>R/L-F</b> 	<b>Für die Zerspantung von Aluminiumlegierungen</b> Große Spankammer. Scharfe Schneidkante erzeugt eine gute Oberfläche.	Aluminiumlegierung 	20° Nebenschneidenprofil DEGX150402R-F
		<b>R/L</b> 	<b>Für die Zerspantung von Aluminiumlegierungen</b> Parallele Spanleitstufe. Scharfe Schneidkante erzeugt eine gute Oberfläche. Hohe Spankontrolle bei mittleren Vorschüben.	Aluminiumlegierung 	25° Nebenschneidenprofil DEGX150402R

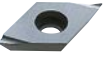











## NEGATIVE WSP OHNE LOCH

Anwendung	Toleranz	Spanbrecherbezeichnung und Abb.	Eigenschaften	Querschnitt Geometrie	
Schruppzerspantung	M	<b>R/L-M1/2</b> 	<b>Für die Schruppzerspantung von C-Stahl und legierten Stahlorten</b> Einseitiger Spanbrecher. Für Kopierdrehen geeignet. Abgewinkelter Spanbrecher zur Kontrolle des Spanablaufs.	C-Stahl Leg. Stahl 	12° Nebenschneidenprofil 0.2 KNUX160405
Für Guss	M	<b>Glatt</b> 	<b>Erste Empfehlung für die Schwerzerspantung von Gusseisen</b> Doppelseitige, glatte Geometrie. Effiziente Geometrie dank der hohen Schneidkantenstabilität.	Guss 	0° SNMN120408
	G	<b>Glatt</b> 	<b>Spanbrecher für die Schwerzerspantung von Gusseisen</b> Doppelseitige, glatte Geometrie. Für den Einsatz unter schwierigen Bedingungen. Höchste Schneidkantenstabilität. Für Werkstücke mit hohen Toleranzanforderungen.	Guss 	0° SNGN120408

	Rhombus 80° 	Rhombus 55° 	Vierkant 90° 	Dreikant 60° 	Rhombus 35° 	Sechskant 80° 	Rund 	Spanbrecher Bezeichnung und Schnittbild
		DEGX_R/L-F  ↻ A153						R/L-F 
		DEGX_R/L  ↻ A153		TEGX_R/L  ↻ A161				R/L 



**A**

WSP DREHEN

	Rhombus 80° 	Vierkant 90° 	Dreikant 60° 	Parallelogramm 55° 	Spanbrecher Bezeichnung und Schnittbild
				KNUX_R/L-M1/2  ↻ A135	R/L-M1/2 
	CNMN  ↻ A136	SNMN  ↻ A137	TNMN  ↻ A138		Glatt(M) 
		SNGN  ↻ A137	TNGN  ↻ A138		Glatt(G) 

# KLASSIFIZIERUNG

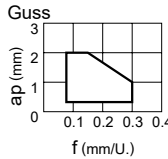







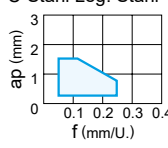

## 7° POSITIVE WENDESCHNEIDPLATTEN OHNE LOCH

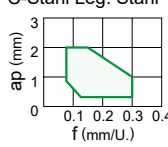
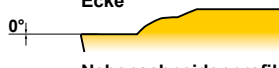

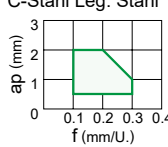
Anwendung	Toleranz	Spanbrecherbezeichnung und Abb.	Eigenschaften	Querschnitt Geometrie
Für Guss	G	<b>Glatt</b> 	<b>Spanbrecher für die Schwerzerspannung von Gusseisen</b> Doppelseitige, glatte Geometrie. Für den Einsatz unter schwierigen Bedingungen. Höchste Schneidkantenstabilität. Für Werkstücke mit hohen Toleranzanforderungen.	Guss  0°  TNGN160408

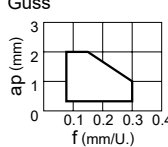

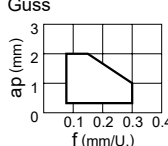















WSP DREHEN

A

## 11° POSITIVE WENDESCHNEIDPLATTEN OHNE LOCH

Anwendung	Toleranz	Spanbrecherbezeichnung und Abb.	Eigenschaften	Querschnitt Geometrie
Schlichtzerspannung	G	<b>R/L</b> 	<b>Schichten</b> Parallele Spanleitstufe. Hohe Spankontrolle bei niedrigen bis mittleren Vorschüben.	C-Stahl Leg. Stahl  15°  Nebenschneidenprofil SPGR090304R
Schlicht- bis mittlere Zerspannung	M	<b>Standard</b> 	<b>Leichte bis mittlere Zerspannung von allgemeinen, legierten und rostfreien Stahlsorten</b> Geometrie für die allgemeine Drehbearbeitung.	C-Stahl Leg. Stahl  0°  Ecke Nebenschneidenprofil SPMR090308
		<b>80</b> 	<b>Leichte bis mittlere Zerspannung von allgemeinen, legierten und rostfreien Stahlsorten</b> Große Spankammer ermöglicht einfache Spanabfuhr. Hohe Spankontrolle dank doppeltem Spanbrecher.	C-Stahl Leg. Stahl  7°  Ecke Nebenschneidenprofil SPMR120308
Für Guss	G	<b>Glatt</b> 	<b>Erste Empfehlung für die Schwerzerspannung von Gusseisen</b> Effiziente Geometrie dank der hohen Schneidkantenstabilität.	Guss  0°  SPMN090308
		<b>Glatt</b> 	<b>Spanbrecher für die Schwerzerspannung von Gusseisen</b> Für den Einsatz unter schwierigen Bedingungen. Höchste Schneidkantenstabilität. Für Werkstücke mit hohen Toleranzanforderungen.	Guss  0°  SPGN090308

	Dreikant 60° 	Spanbrecher Bezeichnung und Schnittbild
	TCGN  ↻ A179	<b>Glatt</b> 

	Vierkant 90° 	Dreikant 60° 	Rund 	Spanbrecher Bezeichnung und Schnittbild
	SPGR_R  ↻ A177	TPGR_R/L  ↻ A180		<b>R/L</b> 
	SPMR  ↻ A177	TPMR  ↻ A180		<b>Standard</b> 
	SPMR-80  ↻ A177	TPMR-80  ↻ A180		<b>80</b> 
	SPMN  ↻ A177	TPMN  ↻ A180		<b>Glatt(M)</b> 
	SPGN  ↻ A178	TPGN  ↻ A181		<b>Glatt(G)</b> 

### WSP FÜR SPEZIELLE ANWENDUNGEN

Anwendung	Toleranz	Halter Ausführung	WSP
Sonder	G	<b>TL Halter</b>	<b>RTG</b>  ↻ A176

## SCHNITTDATENEMPFEHLUNGEN

### NEGATIVE WENDESCHNEIDPLATTEN

Spanbrecher : Std : Standard Flat : Glatt

Material	Härte	Schnittmodus		Priorität	Spanbrecher	Sorte	Schnittgeschw. (m/min)	Vorschub (mm/U.)	Schnitttiefe (mm)
		Symbol	Code						
Allg. Baustahl (St37-2, Ck10)	≤180HB	●	F	1	FY	VP25N	285–450	0.09–0.23	0.20–0.80
		●	F	2	FY	NX2525	270–385	0.09–0.23	0.20–0.80
		●	F	3	FS	NX2525	270–385	0.09–0.23	0.20–0.70
		●	L	1	SY	VP25N	260–410	0.16–0.33	0.50–1.20
		●	L	2	SY	NX2525	245–350	0.16–0.33	0.50–1.20
		●	F	1	FY	MP3025	275–425	0.09–0.23	0.20–0.80
		●	F	2	FY	NX3035	260–370	0.09–0.23	0.20–0.80
		●	F	3	FS	NX2525	270–385	0.09–0.23	0.20–0.70
		●	L	1	SY	MP3025	255–385	0.16–0.33	0.50–1.20
		●	L	2	SY	NX3035	240–340	0.16–0.33	0.50–1.20
		✚	F	1	FY	UE6020	285–465	0.09–0.23	0.20–0.80
		✚	L	1	SY	UE6020	260–425	0.16–0.33	0.50–1.20
C-Stahl Leg. Stahl (Ck45, 42CrMo4)	180   280HB	●	F	1	FP	NX2525	210–300	0.08–0.25	0.10–1.00
		●	F	2	FH	AP25N	220–345	0.08–0.20	0.20–1.00
		●	F	3	FH	NX2525	210–300	0.08–0.20	0.20–1.00
		●	F	4	R/L-F	MP3025	215–330	0.05–0.15	0.10–0.50
		●	F	5	PK	NX2525	200–285	0.10–0.30	0.20–1.00
		●	L	1	LP	MC6115	250–480	0.10–0.40	0.30–2.00
		●	L	2	LP	MC6125	275–425	0.10–0.40	0.30–2.00
		●	L	3	LP	MC6015	210–360	0.10–0.40	0.30–2.00
		●	L	4	LP	UE6105	225–410	0.10–0.40	0.30–2.00
		●	L	5	SH	MC6115	250–480	0.10–0.40	0.30–2.00
		●	L	6	SH	MC6125	275–425	0.10–0.40	0.30–2.00
		●	L	7	SH	UE6105	225–410	0.10–0.40	0.30–2.00
		●	L	8	LP	MP3025	195–300	0.10–0.40	0.30–2.00
		●	L	9	SH	AP25N	200–315	0.10–0.40	0.30–2.00
		●	L	10	SH	NX2525	190–275	0.10–0.40	0.30–2.00
		●	L	11	SA	MC6115	250–480	0.10–0.40	0.30–2.00
		●	L	12	SA	MC6125	275–425	0.10–0.40	0.30–2.00
		●	L	13	SA	UE6105	225–410	0.10–0.40	0.30–2.00
		●	L	14	SA	NX2525	190–275	0.10–0.40	0.30–2.00
		●	L	15	SW	MC6115	250–480	0.10–0.50	0.30–2.50
		●	L	16	SW	MC6125	275–425	0.10–0.50	0.30–2.50
		●	L	17	SW	UE6105	225–410	0.10–0.50	0.30–2.50
		●	L	18	SW	MP3025	195–300	0.10–0.50	0.30–2.50
		●	L	19	SW	NX2525	190–275	0.10–0.50	0.30–2.50
		●	L	20	R/L-K	MP3025	195–300	0.08–0.20	0.30–1.20
		●	M	1	MP	MC6115	230–440	0.16–0.50	0.30–4.00
		●	M	2	MP	MC6125	250–390	0.16–0.50	0.30–4.00
		●	M	3	MP	MC6015	195–330	0.16–0.50	0.30–4.00
		●	M	4	MP	UE6105	205–375	0.16–0.50	0.30–4.00
		●	M	5	MP	MP3025	180–275	0.16–0.50	0.30–4.00
		●	M	6	MA	MC6115	230–440	0.20–0.50	0.30–4.00
		●	M	7	MA	MC6125	250–390	0.20–0.50	0.30–4.00
		●	M	8	MA	UE6105	205–375	0.20–0.50	0.30–4.00
●	M	9	MH	UE6105	205–375	0.20–0.55	1.00–4.00		
●	M	10	Std	MC6115	230–440	0.25–0.60	1.50–5.00		
●	M	11	Std	MC6125	250–390	0.25–0.60	1.50–5.00		

SCHNITTDATENEMPFEHLUNGEN : ● : Stabile Bearbeitung ● : Allgemeine Bearbeitung ✚ : Instabile Bearbeitung

ANWENDUNGSBEREICH : F : Schlichtzerspannung L : Leichtzerspannung M : Mittlere Zerspannung R : Schrumpzerspannung H : Schwerzerspannung

Material	Härte	Schnittmodus		Priorität	Spanbrecher	Sorte	Schnittgeschw. (m/min)	Vorschub (mm/U.)	Schnitttiefe (mm)
		●	M						
P C-Stahl Leg. Stahl (Ck45, 42CrMo4)	180   280HB	●	M	12	Std	UE6105	205–375	0.25–0.60	1.50–5.00
		●	M	13	Std	MP3025	180–275	0.25–0.60	1.50–5.00
		●	M	14	Std	NX2525	175–250	0.25–0.60	1.50–5.00
		●	M	15	Std	UTi20T	90–130	0.25–0.60	1.50–5.00
		●	M	16	MW	MC6115	230–440	0.20–0.60	0.90–4.00
		●	M	17	MW	MC6125	250–390	0.20–0.60	0.90–4.00
		●	M	18	MW	UE6105	205–375	0.20–0.60	0.90–4.00
		●	M	19	R/L	MP3025	180–275	0.15–0.32	0.40–2.00
		●	R	1	RP	MC6115	215–415	0.25–0.60	1.50–6.00
		●	R	2	RP	MC6125	235–370	0.25–0.60	1.50–6.00
		●	R	3	RP	MC6015	185–310	0.25–0.60	1.50–6.00
		●	R	4	RP	UE6105	190–355	0.25–0.60	1.50–6.00
		●	R	5	GH	MC6115	215–415	0.25–0.60	1.50–6.00
		●	R	6	GH	MC6125	235–370	0.25–0.60	1.50–6.00
		●	R	7	GH	UE6105	190–355	0.25–0.60	1.50–6.00
		●	H	1	HX	MC6025	165–265	0.50–1.26	3.00–11.00
		●	H	2	HX	UE6110	165–280	0.50–1.26	3.00–11.00
		●	H	3	HV	MC6025	135–220	0.70–1.30	4.00–12.00
		●	H	4	HV	UE6110	135–230	0.70–1.30	4.00–12.00
		●	H	5	HZ	MC6025	165–265	0.40–1.20	2.00–10.00
		●	H	6	HZ	UE6110	165–280	0.40–1.20	2.00–10.00
		●	H	7	HL	MC6025	165–265	0.40–1.00	1.50–8.00
		●	H	8	HL	UE6110	165–280	0.40–1.00	1.50–8.00
		●	H	9	HM	MC6025	165–265	0.50–1.10	2.00–10.00
		●	H	10	HM	UE6110	165–280	0.50–1.10	2.00–10.00
		●	F	1	FP	MP3025	215–330	0.08–0.25	0.10–1.00
		●	F	2	FH	MP3025	215–330	0.08–0.20	0.20–1.00
		●	F	3	FH	NX3035	200–285	0.08–0.20	0.20–1.00
		●	F	4	FH	UE6110	230–395	0.08–0.20	0.20–1.00
		●	L	1	LP	MC6115	250–480	0.10–0.40	0.30–2.00
		●	L	2	LP	MC6125	275–425	0.10–0.40	0.30–2.00
		●	L	3	LP	MC6015	210–360	0.10–0.40	0.30–2.00
		●	L	4	SH	MC6115	250–480	0.10–0.40	0.30–2.00
		●	L	5	SH	MC6125	275–425	0.10–0.40	0.30–2.00
		●	L	6	SH	MC6015	210–360	0.10–0.40	0.30–2.00
		●	L	7	SA	MC6115	250–480	0.10–0.40	0.30–2.00
		●	L	8	SA	MC6125	275–425	0.10–0.40	0.30–2.00
		●	L	9	SA	MC6015	210–360	0.10–0.40	0.30–2.00
●	L	10	LP	UE6110	210–360	0.10–0.40	0.30–2.00		
●	L	11	SH	UE6110	210–360	0.10–0.40	0.30–2.00		
●	L	12	SA	UE6110	210–360	0.10–0.40	0.30–2.00		
●	L	13	LP	MP3025	195–300	0.10–0.40	0.30–2.00		
●	L	14	SH	NX3035	185–260	0.10–0.40	0.30–2.00		
●	L	15	SA	NX3035	185–260	0.10–0.40	0.30–2.00		
●	L	16	SW	MC6115	250–480	0.10–0.50	0.30–2.50		
●	L	17	SW	MC6125	275–425	0.10–0.50	0.30–2.50		
●	L	18	SW	MC6015	210–360	0.10–0.50	0.30–2.50		
●	L	19	SW	UE6110	210–360	0.10–0.50	0.30–2.50		

A

WSP DREHEN



## SCHNITTDATENEMPFEHLUNGEN

### NEGATIVE WENDESCHNEIDPLATTEN

Spanbrecher : Std : Standard Flat : Glatt

Material	Härte	Schnittmodus	Priorität	Spanbrecher	Sorte	Schnittgeschw. (m/min)	Vorschub (mm/U.)	Schnitttiefe (mm)	
P C-Stahl Leg. Stahl (Ck45, 42CrMo4)	180   280HB	●	L	20	SW	NX3035	185–260	0.10–0.50	0.30–2.50
		●	M	1	MP	MC6125	250–390	0.16–0.50	0.30–4.00
		●	M	2	MP	MC6115	230–440	0.16–0.50	0.30–4.00
		●	M	3	MP	MC6015	195–330	0.16–0.50	0.30–4.00
		●	M	4	MA	MC6125	250–390	0.20–0.50	0.30–4.00
		●	M	5	MA	MC6115	230–440	0.20–0.50	0.30–4.00
		●	M	6	MA	MC6015	195–330	0.20–0.50	0.30–4.00
		●	M	7	MH	MC6125	250–390	0.20–0.55	1.00–4.00
		●	M	8	MH	MC6115	230–440	0.20–0.55	1.00–4.00
		●	M	9	MH	MC6015	195–330	0.20–0.55	1.00–4.00
		●	M	10	Std	MC6125	250–390	0.25–0.60	1.50–5.00
		●	M	11	Std	MC6115	230–440	0.25–0.60	1.50–5.00
		●	M	12	Std	MC6015	195–330	0.25–0.60	1.50–5.00
		●	M	13	MP	UE6110	195–330	0.16–0.50	0.30–4.00
		●	M	14	MA	UE6110	195–330	0.20–0.50	0.30–4.00
		●	M	15	MA	NX3035	170–240	0.20–0.50	0.30–4.00
		●	M	16	MH	UE6110	195–330	0.20–0.55	1.00–4.00
		●	M	17	Std	UE6110	195–330	0.25–0.60	1.50–5.00
		●	M	18	Std	NX3035	170–240	0.25–0.60	1.50–5.00
		●	M	19	MW	MC6125	250–390	0.20–0.60	0.90–4.00
		●	M	20	MW	MC6115	230–440	0.20–0.60	0.90–4.00
		●	M	21	MW	MC6015	195–330	0.20–0.60	0.90–4.00
		●	M	22	MW	UE6110	195–330	0.20–0.60	0.90–4.00
		●	R	1	RP	MC6125	235–370	0.25–0.60	1.50–6.00
		●	R	2	RP	MC6115	215–415	0.25–0.60	1.50–6.00
		●	R	3	RP	MC6015	185–310	0.25–0.60	1.50–6.00
		●	R	4	RP	UE6110	185–310	0.25–0.60	1.50–6.00
		●	R	5	GH	MC6125	235–370	0.25–0.60	1.50–6.00
		●	R	6	GH	MC6115	215–415	0.25–0.60	1.50–6.00
		●	R	7	GH	UE6110	185–310	0.25–0.60	1.50–6.00
		●	H	1	HX	MC6025	165–265	0.50–1.26	3.00–11.00
		●	H	2	HV	MC6025	135–220	0.70–1.30	4.00–12.00
		●	H	3	HZ	MC6025	165–265	0.40–1.20	2.00–10.00
		●	H	4	HL	MC6025	165–265	0.40–1.00	1.50–8.00
		●	H	5	HM	MC6025	165–265	0.50–1.10	2.00–10.00
		●	H	6	HR	MC6025	135–220	0.70–1.30	3.00–12.00
		●	H	7	HZ	UE6110	165–280	0.40–1.20	2.00–10.00
		✚	F	1	FP	MC6025	230–375	0.08–0.25	0.10–1.00
		✚	F	2	FP	MC6015	230–395	0.08–0.25	0.10–1.00
		✚	F	3	FH	UE6110	230–395	0.08–0.20	0.20–1.00
✚	L	1	LP	MC6125	275–425	0.10–0.40	0.30–2.00		
✚	L	2	LP	MC6025	210–345	0.10–0.40	0.30–2.00		
✚	L	3	LP	MC6035	185–260	0.10–0.40	0.30–2.00		
✚	L	4	SH	MC6125	275–425	0.10–0.40	0.30–2.00		
✚	L	5	SH	MC6025	210–345	0.10–0.40	0.30–2.00		
✚	L	6	SA	MC6125	275–425	0.10–0.40	0.30–2.00		
✚	L	7	SA	MC6025	210–345	0.10–0.40	0.30–2.00		
✚	L	8	SA	UE6020	200–330	0.10–0.40	0.30–2.00		

SCHNITTDATENEMPFEHLUNGEN : ● : Stabile Bearbeitung ● : Allgemeine Bearbeitung ✚ : Instabile Bearbeitung

ANWENDUNGSBEREICH : F : Schlichtzerspannung L : Leichtzerspannung M : Mittlere Zerspannung R : Schrappzerspannung H : Schwerzerspannung

Material	Härte	Schnittmodus		Priorität	Spanbrecher	Sorte	Schnittgeschw. (m/min)	Vorschub (mm/U.)	Schnitttiefe (mm)
P C-Stahl Leg. Stahl (Ck45, 42CrMo4)	180   280HB	✚	M	1	MP	MC6125	250–390	0.16–0.50	0.30–4.00
		✚	M	2	MP	MC6025	195–315	0.16–0.50	0.30–4.00
		✚	M	3	MP	MC6035	170–240	0.16–0.50	0.30–4.00
		✚	M	4	MA	MC6125	250–390	0.20–0.50	0.30–4.00
		✚	M	5	MA	MC6025	195–315	0.20–0.50	0.30–4.00
		✚	M	6	MA	MC6035	170–240	0.20–0.50	0.30–4.00
		✚	M	7	MH	MC6125	250–390	0.20–0.55	1.00–4.00
		✚	M	8	MH	MC6025	195–315	0.20–0.55	1.00–4.00
		✚	M	9	MH	MC6035	170–240	0.20–0.55	1.00–4.00
		✚	M	10	Std	MC6125	250–390	0.25–0.60	1.50–5.00
		✚	M	11	Std	MC6025	195–315	0.25–0.60	1.50–5.00
		✚	M	12	Std	MC6035	170–240	0.25–0.60	1.50–5.00
		✚	M	13	MW	MC6125	250–390	0.20–0.60	0.90–4.00
		✚	M	14	MW	MC6025	195–315	0.20–0.60	0.90–4.00
		✚	R	1	RP	MC6125	235–370	0.25–0.60	1.50–6.00
		✚	R	2	RP	MC6025	185–295	0.25–0.60	1.50–6.00
		✚	R	3	RP	MC6035	160–225	0.25–0.60	1.50–6.00
		✚	R	4	GH	MC6125	235–370	0.25–0.60	1.50–6.00
		✚	H	1	HX	MC6035	140–200	0.50–1.26	3.00–11.00
		✚	H	2	HX	UH6400	140–195	0.50–1.26	3.00–11.00
		✚	H	3	HV	MC6035	115–165	0.70–1.30	4.00–12.00
		✚	H	4	HV	UH6400	115–160	0.70–1.30	4.00–12.00
		✚	H	5	HZ	MC6035	140–200	0.40–1.20	2.00–10.00
		✚	H	6	HZ	UH6400	140–195	0.40–1.20	2.00–10.00
		✚	H	7	HL	MC6035	140–200	0.40–1.00	1.50–8.00
		✚	H	8	HM	MC6035	140–200	0.50–1.10	2.00–10.00
		✚	H	9	HR	MC6035	115–165	0.70–1.30	3.00–12.00

A

WSP DREHEN

## SCHNITTDATENEMPFEHLUNGEN

### ■ NEGATIVE WENDESCHNEIDPLATTEN

Spanbrecher : Std : Standard Flat : Glatt

Material	Härte	Schnittmodus		Priorität	Spanbrecher	Sorte	Schnittgeschw. (m/min)	Vorschub (mm/U.)	Schnitttiefe (mm)
Rostfreier Stahl (austenitisch) (X5CrNi189, X5CrNiMo1810)	≤200HB	●	L	1	LM	MC7015	180–285	0.10–0.30	0.30–2.00
		●	L	2	SH	US735	95–185	0.10–0.40	0.30–2.00
		●	L	3	SH	NX2525	65–135	0.10–0.40	0.30–2.00
		●	M	1	MM	MC7015	165–260	0.15–0.45	0.70–5.00
		●	M	2	GM	MC7015	165–260	0.16–0.50	0.50–4.00
		●	R	1	RM	MC7015	155–245	0.25–0.55	1.50–6.00
		●	H	1	HL	US735	75–140	0.40–1.00	1.50–8.00
		●	H	2	HL	US735	75–140	0.40–1.00	1.50–8.00
		●	L	1	LM	MC7025	165–220	0.10–0.30	0.30–2.00
		●	L	2	SH	US735	95–185	0.10–0.40	0.30–2.00
		●	M	1	MM	MC7025	150–200	0.15–0.45	0.70–5.00
		●	M	2	GM	MC7025	150–200	0.16–0.50	0.50–4.00
		●	M	3	MA	MC7025	150–200	0.20–0.50	0.30–4.00
		●	M	4	MS	US735	90–170	0.16–0.50	0.50–4.00
		●	M	5	MA	US735	90–170	0.20–0.50	0.30–4.00
		●	R	1	RM	MC7025	140–190	0.25–0.55	1.50–6.00
		●	R	2	GH	US735	85–160	0.25–0.60	1.50–6.00
		●	H	1	HL	US735	75–140	0.40–1.00	1.50–8.00
		●	H	2	HM	US735	75–140	0.50–1.10	2.00–10.00
		✚	L	1	LM	MP7035	95–155	0.10–0.30	0.30–2.00
		✚	L	2	SH	US735	95–185	0.10–0.40	0.30–2.00
		✚	M	1	MM	MP7035	90–145	0.15–0.45	0.70–5.00
		✚	M	2	GM	MP7035	90–145	0.16–0.50	0.50–4.00
		✚	M	3	MA	MP7035	90–145	0.20–0.50	0.30–4.00
		✚	M	4	MS	US735	90–170	0.16–0.50	0.50–4.00
		✚	M	5	MS	VP15TF	80–135	0.16–0.50	0.50–4.00
		✚	M	6	MS	UP20M	100–150	0.16–0.50	0.50–4.00
		✚	M	7	MS	UTi20T	80–115	0.16–0.50	0.50–4.00
		✚	M	8	MA	VP15TF	80–135	0.20–0.50	0.30–4.00
		✚	M	9	Std	VP15TF	80–135	0.25–0.60	1.50–5.00
		✚	R	1	RM	MP7035	85–135	0.25–0.55	1.50–6.00
		✚	R	2	GH	US735	85–160	0.25–0.60	1.50–6.00
		✚	H	1	HL	US735	75–140	0.40–1.00	1.50–8.00
✚	H	2	HM	US735	75–140	0.50–1.10	2.00–10.00		
Rostfreier Stahl (austenitisch) (X2CrNiN1810, X2CrNiMoN1813)	>200HB	●	L	1	LM	MC7015	150–240	0.10–0.30	0.30–2.00
		●	L	2	SH	US735	80–155	0.10–0.40	0.30–2.00
		●	L	3	SH	NX2525	55–115	0.10–0.40	0.30–2.00
		●	M	1	MM	MC7015	135–215	0.15–0.45	0.70–5.00
		●	M	2	GM	MC7015	135–215	0.16–0.50	0.50–4.00
		●	R	1	RM	MC7015	130–205	0.25–0.55	1.50–6.00
		●	H	1	HL	US735	60–120	0.40–1.00	1.50–8.00
		●	H	2	HM	US735	60–120	0.50–1.10	2.00–10.00
		●	L	1	LM	MC7025	135–180	0.10–0.30	0.30–2.00
		●	L	2	SH	US735	80–155	0.10–0.40	0.30–2.00
		●	M	1	MM	MC7025	125–165	0.15–0.45	0.70–5.00
		●	M	2	GM	MC7025	125–165	0.16–0.50	0.50–4.00
		●	M	3	MA	MC7025	125–165	0.20–0.50	0.30–4.00
		●	M	4	MS	US735	75–140	0.16–0.50	0.50–4.00

SCHNITTDATENEMPFEHLUNGEN : ● : Stabile Bearbeitung ● : Allgemeine Bearbeitung ✚ : Instabile Bearbeitung

ANWENDUNGSBEREICH : F : Schlichtzerspannung L : Leichtzerspannung M : Mittlere Zerspannung R : Schrupperzerspannung H : Schwerzerspannung

Material	Härte	Schnittmodus		Priorität	Spanbrecher	Sorte	Schnittgeschw. (m/min)	Vorschub (mm/U.)	Schnitttiefe (mm)
Rostfreier Stahl (austenitisch) (X2CrNiN1810, X2CrNiMoN1813)	>200HB	☉	M	5	MA	US735	75–140	0.20–0.50	0.30–4.00
		☉	R	1	RM	MC7025	115–155	0.25–0.55	1.50–6.00
		☉	R	2	GH	US735	70–135	0.25–0.60	1.50–6.00
		☉	H	1	HL	US735	60–120	0.40–1.00	1.50–8.00
		☉	H	2	HM	US735	60–120	0.50–1.10	2.00–10.00
		☼	L	1	LM	MP7035	80–130	0.10–0.30	0.30–2.00
		☼	L	2	SH	US735	80–155	0.10–0.40	0.30–2.00
		☼	M	1	MM	MP7035	75–120	0.15–0.45	0.70–5.00
		☼	M	2	GM	MP7035	75–120	0.16–0.50	0.50–4.00
		☼	M	3	MA	MP7035	75–120	0.20–0.50	0.30–4.00
		☼	M	4	MS	US735	75–140	0.16–0.50	0.50–4.00
		☼	M	5	MS	VP15TF	65–110	0.16–0.50	0.50–4.00
		☼	M	6	MS	UP20M	80–125	0.16–0.50	0.50–4.00
		☼	M	7	MS	UTi20T	65–95	0.16–0.50	0.50–4.00
		☼	M	8	MA	VP15TF	65–110	0.20–0.50	0.30–4.00
		☼	M	9	Std	VP15TF	65–110	0.25–0.60	1.50–5.00
		☼	R	1	RM	MP7035	70–115	0.25–0.55	1.50–6.00
		☼	R	2	GH	US735	70–135	0.25–0.60	1.50–6.00
☼	H	1	HL	US735	60–120	0.40–1.00	1.50–8.00		
☼	H	2	HM	US735	60–120	0.50–1.10	2.00–10.00		
Duplex, rostfreier Stahl (X3CrNiCu1894)	≤280HB	●	L	1	LM	MC7015	120–190	0.10–0.30	0.30–2.00
		●	L	2	SH	US735	65–125	0.10–0.40	0.30–2.00
		●	L	3	SH	NX2525	40–90	0.10–0.40	0.30–2.00
		●	M	1	MM	MC7015	110–175	0.15–0.45	0.70–5.00
		●	M	2	GM	MC7015	110–175	0.16–0.50	0.50–4.00
		●	R	1	RM	MC7015	105–165	0.25–0.55	1.50–6.00
		●	H	1	HL	US735	50–95	0.40–1.00	1.50–8.00
		●	H	2	HM	US735	50–95	0.50–1.10	2.00–10.00
		☉	L	1	LM	MC7025	110–145	0.10–0.30	0.30–2.00
		☉	L	2	SH	US735	65–125	0.10–0.40	0.30–2.00
		☉	M	1	MM	MC7025	100–135	0.15–0.45	0.70–5.00
		☉	M	2	GM	MC7025	100–135	0.16–0.50	0.50–4.00
		☉	M	3	MA	MC7025	100–135	0.20–0.50	0.30–4.00
		☉	M	4	MS	US735	60–115	0.16–0.50	0.50–4.00
		☉	M	5	MA	US735	60–115	0.20–0.50	0.30–4.00
		☉	R	1	RM	MC7025	95–125	0.25–0.55	1.50–6.00
		☉	R	2	GH	US735	55–105	0.25–0.60	1.50–6.00
		☉	H	1	HL	US735	50–95	0.40–1.00	1.50–8.00
		☉	H	2	HM	US735	50–95	0.50–1.10	2.00–10.00
		☼	L	1	LM	MP7035	65–105	0.10–0.30	0.30–2.00
		☼	L	2	SH	US735	65–125	0.10–0.40	0.30–2.00
		☼	M	1	MM	MP7035	60–95	0.15–0.45	0.70–5.00
		☼	M	2	GM	MP7035	60–95	0.16–0.50	0.50–4.00
		☼	M	3	MA	MP7035	60–95	0.20–0.50	0.30–4.00
		☼	M	4	MS	US735	60–115	0.16–0.50	0.50–4.00
		☼	M	5	MS	VP15TF	50–90	0.16–0.50	0.50–4.00
		☼	M	6	MS	UP20M	65–100	0.16–0.50	0.50–4.00
☼	M	7	MS	UTi20T	50–75	0.16–0.50	0.50–4.00		

A

WSP DREHEN

M

## SCHNITTDATENEMPFEHLUNGEN

### NEGATIVE WENDESCHNEIDPLATTEN

Spanbrecher : Std : Standard Flat : Glatt

Material	Härte	Schnittmodus		Priorität	Spanbrecher	Sorte	Schnittgeschw. (m/min)	Vorschub (mm/U.)	Schnitttiefe (mm)
		Symbol	Modus						
Duplex, rostfreier Stahl (X3CrNiCu1894)	≤280HB	✚	M	8	MA	VP15TF	50–90	0.20–0.50	0.30–4.00
		✚	M	9	Std	VP15TF	50–90	0.25–0.60	1.50–5.00
		✚	R	1	RM	MP7035	55–90	0.25–0.55	1.50–6.00
		✚	R	2	GH	US735	55–105	0.25–0.60	1.50–6.00
		✚	H	1	HL	US735	50–95	0.40–1.00	1.50–8.00
		✚	H	2	HM	US735	50–95	0.50–1.10	2.00–10.00
Rostfreie Stähle, austenitisch und martensitisch (X10Cr13, X8Cr17)	≤200HB	●	L	1	LM	MC7015	180–285	0.10–0.30	0.30–2.00
		●	L	2	SH	US735	95–185	0.10–0.40	0.30–2.00
		●	L	3	SH	NX2525	65–135	0.10–0.40	0.30–2.00
		●	M	1	MM	MC7015	165–260	0.15–0.45	0.70–5.00
		●	M	2	GM	MC7015	165–260	0.16–0.50	0.50–4.00
		●	R	1	RM	MC7015	155–245	0.25–0.55	1.50–6.00
		●	H	1	HL	US735	75–140	0.40–1.00	1.50–8.00
		●	H	2	HM	US735	75–140	0.50–1.10	2.00–10.00
		●	L	1	LM	MC7025	165–220	0.10–0.30	0.30–2.00
		●	L	2	SH	US735	95–185	0.10–0.40	0.30–2.00
		●	M	1	MM	MC7025	150–200	0.15–0.45	0.70–5.00
		●	M	2	GM	MC7025	150–200	0.16–0.50	0.50–4.00
		●	M	3	MA	MC7025	150–200	0.20–0.50	0.30–4.00
		●	M	4	MA	US735	90–170	0.20–0.50	0.30–4.00
		●	M	5	MS	US735	90–170	0.16–0.50	0.50–4.00
		●	R	1	RM	MC7025	140–190	0.25–0.55	1.50–6.00
		●	R	2	GH	US735	85–160	0.25–0.60	1.50–6.00
		●	H	1	HL	US735	75–140	0.40–1.00	1.50–8.00
		●	H	2	HM	US735	75–140	0.50–1.10	2.00–10.00
		✚	L	1	LM	MP7035	95–155	0.10–0.30	0.30–2.00
		✚	L	2	SH	US735	95–185	0.10–0.40	0.30–2.00
		✚	M	1	MM	MP7035	90–145	0.15–0.45	0.70–5.00
		✚	M	2	GM	MP7035	90–145	0.16–0.50	0.50–4.00
		✚	M	3	MA	MP7035	90–145	0.20–0.50	0.30–4.00
		✚	M	4	MS	US735	90–170	0.16–0.50	0.50–4.00
		✚	M	5	MS	VP15TF	80–135	0.16–0.50	0.50–4.00
		✚	M	6	MS	UP20M	100–150	0.16–0.50	0.50–4.00
		✚	M	7	MS	UTi20T	80–115	0.16–0.50	0.50–4.00
		✚	M	8	MA	VP15TF	80–135	0.20–0.50	0.30–4.00
		✚	M	9	Std	VP15TF	80–135	0.25–0.60	1.50–5.00
✚	R	1	RM	MP7035	85–135	0.25–0.55	1.50–6.00		
✚	R	2	GH	US735	85–160	0.25–0.60	1.50–6.00		
✚	H	1	HL	US735	75–140	0.40–1.00	1.50–8.00		
✚	H	2	HM	US735	75–140	0.50–1.10	2.00–10.00		
Rostfreie Stähle, austenitisch und martensitisch (X17CrNi162, X30Cr13)	>200HB	●	L	1	LM	MC7015	150–240	0.10–0.30	0.30–2.00
		●	L	2	SH	US735	80–155	0.10–0.40	0.30–2.00
		●	L	3	SH	NX2525	55–115	0.10–0.40	0.30–2.00
		●	M	1	MM	MC7015	135–215	0.15–0.45	0.70–5.00
		●	M	2	GM	MC7015	135–215	0.16–0.50	0.50–4.00
		●	R	1	RM	MC7015	130–205	0.25–0.55	1.50–6.00
		●	H	1	HL	US735	60–120	0.40–1.00	1.50–8.00
		●	H	2	HM	US735	60–120	0.50–1.10	2.00–10.00

SCHNITTDATENEMPFEHLUNGEN : ● : Stabile Bearbeitung ● : Allgemeine Bearbeitung ✚ : Instabile Bearbeitung

ANWENDBEREICH : F : Schlichtzerspannung L : Leichtzerspannung M : Mittlere Zerspannung R : Schrappzerspannung H : Schwerzerspannung

Material	Härte	Schnittmodus		Priorität	Spanbrecher	Sorte	Schnittgeschw. (m/min)	Vorschub (mm/U.)	Schnitttiefe (mm)
		☉	☽						
Rostfreie Stähle, austenitisch und martensitisch (X17CrNi162, X30Cr13)	>200HB	☉	L	1	LM	MC7025	135–180	0.10–0.30	0.30–2.00
		☉	L	2	SH	US735	80–155	0.10–0.40	0.30–2.00
		☉	M	1	MM	MC7025	125–165	0.15–0.45	0.70–5.00
		☉	M	2	MA	MC7025	125–165	0.20–0.50	0.30–4.00
		☉	M	3	MA	US735	75–140	0.20–0.50	0.30–4.00
		☉	M	4	MS	US735	75–140	0.16–0.50	0.50–4.00
		☉	R	1	RM	MC7025	115–155	0.25–0.55	1.50–6.00
		☉	R	2	GH	US735	70–135	0.25–0.60	1.50–6.00
		☉	H	1	HL	US735	60–120	0.40–1.00	1.50–8.00
		☉	H	2	HM	US735	60–120	0.50–1.10	2.00–10.00
		☼	L	1	LM	MP7035	80–130	0.10–0.30	0.30–2.00
		☼	L	2	SH	US735	80–155	0.10–0.40	0.30–2.00
		☼	M	1	MM	MP7035	75–120	0.15–0.45	0.70–5.00
		☼	M	2	GM	MP7035	75–120	0.16–0.50	0.50–4.00
		☼	M	3	MA	MP7035	75–120	0.20–0.50	0.30–4.00
		☼	M	4	MS	US735	75–140	0.16–0.50	0.50–4.00
		☼	M	5	MS	VP15TF	65–110	0.16–0.50	0.50–4.00
		☼	M	6	MS	UP20M	80–125	0.16–0.50	0.50–4.00
		☼	M	7	MS	UTi20T	65–95	0.16–0.50	0.50–4.00
		☼	M	8	MA	VP15TF	65–110	0.20–0.50	0.30–4.00
☼	M	9	Std	VP15TF	65–110	0.25–0.60	1.50–5.00		
☼	R	1	RM	MP7035	70–115	0.25–0.55	1.50–6.00		
☼	R	2	GH	US735	70–135	0.25–0.60	1.50–6.00		
☼	H	1	HL	US735	60–120	0.40–1.00	1.50–8.00		
☼	H	2	HM	US735	60–120	0.50–1.10	2.00–10.00		
Gehärtete rostfreie PH-Stähle (X5CrNiCuNb16-4, X7CrNiAl17-7)	<450HB	☉	L	1	LM	MC7015	95–130	0.10–0.30	0.30–2.00
		☉	L	2	LS(M)	MP9005	125–175	0.10–0.25	0.20–0.80
		☉	L	3	SH	US735	55–100	0.10–0.40	0.30–2.00
		☉	L	4	SH	NX2525	35–75	0.10–0.40	0.30–2.00
		☉	M	1	MM	MC7015	90–120	0.15–0.45	0.70–5.00
		☉	M	2	GM	MC7015	90–120	0.16–0.50	0.50–4.00
		☉	M	3	MS	MP9005	115–160	0.15–0.30	0.50–3.00
		☉	R	1	RM	MC7015	85–110	0.25–0.55	1.50–6.00
		☉	H	1	HL	US735	40–80	0.40–1.00	1.50–8.00
		☉	H	2	HM	US735	40–80	0.50–1.10	2.00–10.00
		☉	L	1	LM	MC7025	85–110	0.10–0.30	0.30–2.00
		☉	L	2	SH	US735	55–100	0.10–0.40	0.30–2.00
		☉	L	3	LS(M)	MP9015	120–165	0.10–0.25	0.20–0.80
		☉	M	1	MM	MC7025	80–100	0.15–0.45	0.70–5.00
		☉	M	2	GM	MC7025	80–100	0.16–0.50	0.50–4.00
		☉	M	3	MA	MC7025	80–100	0.10–0.30	0.50–3.00
		☉	M	4	MS	US735	50–95	0.15–0.30	0.50–3.00
		☉	M	5	MA	US735	50–95	0.10–0.30	0.50–3.00
		☉	M	6	MS	MP9015	110–150	0.15–0.30	0.50–3.00
		☉	R	1	RM	MC7025	75–95	0.25–0.55	1.50–6.00
☉	R	2	GH	US735	45–90	0.25–0.60	1.50–6.00		
☉	R	3	RS	MP9015	100–140	0.20–0.35	1.00–4.00		
☉	H	1	HL	US735	40–80	0.40–1.00	1.50–8.00		

A

WSP DREHEN

M

## SCHNITTDATENEMPFEHLUNGEN

### NEGATIVE WENDESCHNEIDPLATTEN

Spanbrecher : Std : Standard Flat : Glatt

Material	Härte	Schnittmodus		Priorität	Spanbrecher	Sorte	Schnittgeschw. (m/min)	Vorschub (mm/U.)	Schnittiefe (mm)
		Symbol	Spannung						
Rostfreie Stähle, austenitisch und martensitisch (X17CrNi162, X30Cr13)	>200HB	●	H	2	HM	US735	40–80	0.50–1.10	2.00–10.00
		✚	L	1	LM	MP7035	55–85	0.10–0.30	0.30–2.00
		✚	L	2	SH	US735	55–100	0.10–0.40	0.30–2.00
		✚	L	3	LS(M)	MP9025	80–95	0.10–0.25	0.20–0.80
		✚	M	1	MM	MP7035	50–80	0.15–0.45	0.70–5.00
		✚	M	2	GM	MP7035	50–80	0.16–0.50	0.50–4.00
		✚	M	3	MA	MP7035	50–80	0.10–0.30	0.50–3.00
		✚	M	4	MS	US735	50–95	0.15–0.30	0.50–3.00
		✚	M	5	MS	VP15TF	45–75	0.15–0.30	0.50–3.00
		✚	M	6	MS	UP20M	55–85	0.15–0.30	0.50–3.00
		✚	M	7	MS	UTi20T	45–65	0.15–0.30	0.50–3.00
		✚	M	8	MA	VP15TF	45–75	0.10–0.30	0.50–3.00
		✚	M	9	Std	VP15TF	45–75	0.25–0.60	1.50–5.00
		✚	M	10	MS	MP9025	75–90	0.15–0.30	0.50–3.00
		✚	R	1	RM	MP7035	45–75	0.25–0.55	1.50–6.00
		✚	R	2	GH	US735	45–90	0.25–0.60	1.50–6.00
		✚	R	3	RS	MP9025	70–85	0.20–0.35	1.00–4.00
		✚	H	1	HL	US735	40–80	0.40–1.00	1.50–8.00
✚	H	2	HM	US735	40–80	0.50–1.10	2.00–10.00		

WSP DREHEN

A

M

SCHNITTDATENEMPFEHLUNGEN : ● : Stabile Bearbeitung ● : Allgemeine Bearbeitung ✚ : Instabile Bearbeitung

ANWENDUNGSBEREICH : F : Schlichtzerspannung L : Leichtzerspannung M : Mittlere Zerspannung R : Schrappzerspannung H : Schwerzerspannung



Material	Zugfestigkeit	Schnittmodus		Priorität	Spanbrecher	Sorte	Schnittgeschw. (m/min)	Vorschub (mm/U.)	Schnitttiefe (mm)		
Grauguss (GG30)	≤350MPa	●	L	1	LK	MC5005	230–365	0.10–0.40	0.30–2.00		
		●	L	2	MA	MC5005	210–335	0.20–0.50	0.30–4.00		
		●	M	1	MK	MC5005	210–335	0.20–0.55	1.00–4.00		
		●	M	2	GK	MC5005	210–335	0.25–0.60	1.50–5.00		
		●	M	3	Std	NX2525	155–210	0.25–0.60	1.50–5.00		
		●	M	4	MW	MC5005	210–335	0.20–0.60	0.90–4.00		
		●	R	1	RK	MC5005	195–315	0.25–0.60	1.50–6.00		
		●	R	2	Flat	MC5005	195–315	0.20–0.60	2.50–6.00		
		●	R	3	Flat	HTi10	95–140	0.20–0.60	2.50–6.00		
		●	H	1	Flat	MC5005	195–315	0.20–0.60	2.50–6.00		
		●	L	1	LK	MC5015	205–335	0.10–0.40	0.30–2.00		
		●	L	2	MA	MC5015	190–305	0.20–0.50	0.30–4.00		
		●	L	3	SW	MC5015	205–335	0.10–0.50	0.30–2.50		
		●	M	1	MK	MC5015	190–305	0.20–0.55	1.00–4.00		
		●	M	2	GK	MC5015	190–305	0.25–0.60	1.50–5.00		
		●	M	3	Std	HTi10	105–150	0.25–0.60	1.50–5.00		
		●	M	4	MW	MC5015	190–305	0.20–0.60	0.90–4.00		
		●	R	1	RK	MC5015	180–285	0.25–0.60	1.50–6.00		
		●	R	2	Flat	MC5015	180–285	0.20–0.60	2.50–6.00		
		●	H	1	Flat	MC5015	180–285	0.20–0.60	2.50–6.00		
		⊕	L	1	LK	MC5015	205–335	0.10–0.40	0.30–2.00		
		⊕	L	2	MA	MC5015	190–305	0.20–0.50	0.30–4.00		
		⊕	M	1	MK	MC5015	190–305	0.20–0.55	1.00–4.00		
		⊕	M	2	GK	MC5015	190–305	0.25–0.60	1.50–5.00		
		⊕	M	3	Std	UTi20T	85–120	0.25–0.60	1.50–5.00		
		⊕	R	1	RK	MC5015	180–285	0.25–0.60	1.50–6.00		
		⊕	R	2	Flat	MC5015	180–285	0.20–0.60	2.50–6.00		
		⊕	R	3	Flat	UTi20T	80–110	0.20–0.60	2.50–6.00		
		⊕	H	1	Flat	MC5015	180–285	0.20–0.60	2.50–6.00		
		Duktiler Guss (GGG40)	≤450MPa	●	L	1	LK	MC5005	215–350	0.10–0.40	0.30–2.00
				●	L	2	MA	MC5005	195–315	0.20–0.50	0.30–4.00
				●	M	1	MK	MC5005	195–315	0.20–0.55	1.00–4.00
●	M			2	GK	MC5005	195–315	0.25–0.60	1.50–5.00		
●	M			3	Std	NX2525	145–195	0.25–0.60	1.50–5.00		
●	R			1	RK	MC5005	185–300	0.25–0.60	1.50–6.00		
●	R			2	Flat	MC5005	185–300	0.20–0.60	2.50–6.00		
●	R			3	Flat	HTi10	90–135	0.20–0.60	2.50–6.00		
●	H			1	Flat	MC5005	185–300	0.20–0.60	2.50–6.00		
●	L			1	LK	MC5015	195–315	0.10–0.40	0.30–2.00		
●	L			2	MA	MC5015	180–285	0.20–0.50	0.30–4.00		
●	L			3	SW	MC5015	195–315	0.10–0.50	0.30–2.50		
●	M			1	MK	MC5015	180–285	0.20–0.55	1.00–4.00		
●	M			2	GK	MC5015	180–285	0.25–0.60	1.50–5.00		
●	M			3	Std	HTi10	95–140	0.25–0.60	1.50–5.00		
●	R			1	RK	MC5015	170–275	0.25–0.60	1.50–6.00		
●	R			2	Flat	MC5015	170–275	0.20–0.60	2.50–6.00		
●	H			1	Flat	MC5015	170–275	0.20–0.60	2.50–6.00		
⊕	L			1	LK	MC5015	195–315	0.10–0.40	0.30–2.00		

A

WSP DREHEN

K

## SCHNITTDATENEMPFEHLUNGEN

### NEGATIVE WENDESCHNEIDPLATTEN

Spanbrecher : Std : Standard Flat : Glatt

Material	Zugfestigkeit	Schnittmodus	Priorität	Spanbrecher	Sorte	Schnittgeschw. (m/min)	Vorschub (mm/U.)	Schnitttiefe (mm)	
Duktiler Guss (GGG40)	≤450MPa	✚	L	2	MA	MC5015	180–285	0.20–0.50	0.30–4.00
		✚	M	1	MK	MC5015	180–285	0.20–0.55	1.00–4.00
		✚	M	2	GK	MC5015	180–285	0.25–0.60	1.50–5.00
		✚	M	3	Std	UTi20T	80–110	0.25–0.60	1.50–5.00
		✚	R	1	RK	MC5015	170–275	0.25–0.60	1.50–6.00
		✚	R	2	Flat	MC5015	170–275	0.20–0.60	2.50–6.00
		✚	R	3	Flat	UTi20T	75–105	0.20–0.60	2.50–6.00
Duktiler Guss (GGG70)	≤800MPa	●	L	1	LK	MC5005	195–310	0.10–0.40	0.30–2.00
		●	L	2	MA	MC5005	175–280	0.20–0.50	0.30–4.00
		●	M	1	MK	MC5005	175–280	0.20–0.55	1.00–4.00
		●	M	2	GK	MC5005	175–280	0.25–0.60	1.50–5.00
		●	M	3	Std	NX2525	130–175	0.25–0.60	1.50–5.00
		●	R	1	RK	MC5005	165–270	0.25–0.60	1.50–6.00
		●	R	2	Flat	MC5005	165–270	0.20–0.60	2.50–6.00
		●	R	3	Flat	HTi10	80–120	0.20–0.60	2.50–6.00
		●	H	1	Flat	MC5005	165–270	0.20–0.60	2.50–6.00
		●	L	1	LK	MC5015	175–285	0.10–0.40	0.30–2.00
		●	L	2	MA	MC5015	160–255	0.20–0.50	0.30–4.00
		●	L	3	SW	MC5015	175–285	0.10–0.50	0.30–2.50
		●	M	1	MK	MC5015	160–255	0.20–0.55	1.00–4.00
		●	M	2	GK	MC5015	160–255	0.25–0.60	1.50–5.00
		●	M	3	Std	HTi10	85–125	0.25–0.60	1.50–5.00
		●	R	1	RK	MC5015	150–245	0.25–0.60	1.50–6.00
		●	R	2	Flat	MC5015	150–245	0.20–0.60	2.50–6.00
		●	H	1	Flat	MC5015	150–245	0.20–0.60	2.50–6.00
		✚	L	1	LK	MC5015	175–285	0.10–0.40	0.30–2.00
		✚	L	2	MA	MC5015	160–255	0.20–0.50	0.30–4.00
		✚	M	1	MK	MC5015	160–255	0.20–0.55	1.00–4.00
		✚	M	2	GK	MC5015	160–255	0.25–0.60	1.50–5.00
		✚	M	3	Std	UTi20T	70–100	0.25–0.60	1.50–5.00
		✚	R	1	RK	MC5015	150–245	0.25–0.60	1.50–6.00
		✚	R	2	Flat	MC5015	150–245	0.20–0.60	2.50–6.00
		✚	R	3	Flat	UTi20T	65–95	0.20–0.60	2.50–6.00
		✚	H	1	Flat	MC5015	150–245	0.20–0.60	2.50–6.00

WSP DREHEN

A

K

SCHNITTDATENEMPFEHLUNGEN : ● : Stabile Bearbeitung ● : Allgemeine Bearbeitung ✚ : Instabile Bearbeitung

ANWENDBEREICH : F : Schlichtzerspannung L : Leichtzerspannung M : Mittlere Zerspannung R : Schrumpferspannung H : Schwerzerspannung

Material	Härte	Schnittmodus		Priorität	Spanbrecher	Sorte	Schnittgeschw. (m/min)	Vorschub (mm/U.)	Schnitttiefe (mm)		
		Symbol	Code								
Titanlegierung (Ti-6Al-4V)	—	●	F	1	LS(M)	MT9015	40–85	0.10–0.25	0.20–0.80		
		●	F	2	FJ	RT9010	45–95	0.07–0.20	0.10–1.00		
		●	L	1	LS(M)	MT9015	40–85	0.10–0.25	0.20–0.80		
		●	L	2	MJ(M)	RT9010	40–85	0.07–0.25	0.40–1.50		
		●	M	1	MS	MT9015	40–80	0.15–0.30	0.50–3.00		
		●	M	2	MS	RT9010	40–80	0.15–0.30	0.50–3.00		
		●	R	1	RS	MT9015	35–75	0.20–0.35	1.00–4.00		
		●	R	2	GJ	RT9010	35–75	0.16–0.35	1.00–3.00		
		●	F	1	LS(M)	MT9015	40–85	0.10–0.25	0.20–0.80		
		●	F	2	FJ	RT9010	45–95	0.07–0.20	0.10–1.00		
		●	L	1	LS(M)	MT9015	40–85	0.10–0.25	0.20–0.80		
		●	L	2	MJ(M)	RT9010	40–85	0.07–0.25	0.40–1.50		
		●	L	3	MJ(G)	RT9010	40–85	0.07–0.25	0.40–1.50		
		●	M	1	MS	MT9015	40–80	0.15–0.30	0.50–3.00		
		●	M	2	MS	RT9010	40–80	0.15–0.30	0.50–3.00		
		●	R	1	RS	MT9015	35–75	0.20–0.35	1.00–4.00		
		●	R	2	GJ	RT9010	35–75	0.16–0.35	1.00–3.00		
		⊕	F	1	LS(M)	MT9015	40–85	0.10–0.25	0.20–0.80		
		⊕	F	2	FJ	RT9010	45–95	0.07–0.20	0.10–1.00		
		⊕	L	1	LS(M)	MT9015	40–85	0.10–0.25	0.20–0.80		
		⊕	L	2	MJ(M)	RT9010	40–85	0.07–0.25	0.40–1.50		
		⊕	L	3	MJ(G)	RT9010	40–85	0.07–0.25	0.40–1.50		
		⊕	M	1	MS	MT9015	40–80	0.15–0.30	0.50–3.00		
		⊕	R	1	RS	MT9015	35–75	0.20–0.35	1.00–4.00		
		⊕	R	2	GJ	RT9010	35–75	0.16–0.35	1.00–3.00		
		Hitzebeständiger Stahl (Inconel718)	—	●	F	1	LS(M)	MP9005	30–110	0.10–0.25	0.20–0.80
				●	F	2	FJ	VP10RT	30–60	0.07–0.20	0.10–1.00
				●	L	1	LS(M)	MP9005	30–110	0.10–0.25	0.20–0.80
●	L			2	MJ(M)	MP9005	30–110	0.07–0.25	0.40–1.50		
●	L			3	MJ(M)	VP05RT	30–65	0.07–0.25	0.40–1.50		
●	L			4	MJ(M)	US905	55–110	0.07–0.25	0.40–1.50		
●	L			5	MJ(G)	VP10RT	25–55	0.07–0.25	0.40–1.50		
●	M			1	MS	MP9005	30–100	0.15–0.30	0.50–3.00		
●	M			2	MS	VP05RT	30–60	0.15–0.30	0.50–3.00		
●	M			3	MS	US905	50–100	0.15–0.30	0.50–3.00		
●	R			1	RS	MP9015	20–75	0.20–0.35	1.00–4.00		
●	R			2	GJ	VP10RT	20–45	0.16–0.35	1.00–3.00		
●	R			3	GJ	US905	45–95	0.16–0.35	1.00–3.00		
●	F			1	LS(M)	MP9015	25–85	0.10–0.25	0.20–0.80		
●	F			2	FJ	VP10RT	30–60	0.07–0.20	0.10–1.00		
●	L			1	LS(M)	MP9015	25–85	0.10–0.25	0.20–0.80		
●	L			2	MJ(M)	MP9015	25–80	0.07–0.25	0.40–1.50		
●	L			3	MJ(M)	VP10RT	25–55	0.07–0.25	0.40–1.50		
●	M			1	MS	MP9015	25–80	0.15–0.30	0.50–3.00		
●	M			2	MA	MP9015	25–80	0.10–0.30	0.50–3.00		
●	M			3	MS	VP10RT	25–50	0.15–0.30	0.50–3.00		
●	R			1	RS	MP9015	20–75	0.20–0.35	1.00–4.00		
●	R			2	GJ	VP10RT	20–45	0.16–0.35	1.00–3.00		

A

WSP DREHEN

S

## SCHNITTDATENEMPFEHLUNGEN

### ■ NEGATIVE WENDESCHNEIDPLATTEN

Spanbrecher : Std : Standard Flat : Glatt

Material	Härte	Schnittmodus	Priorität	Spanbrecher	Sorte	Schnittgeschw. (m/min)	Vorschub (mm/U.)	Schnitttiefe (mm)
s Hitzebeständiger Stahl (Inconel718)	—	✚ F	1	LS(M)	MP9025	20–30	0.10–0.25	0.20–0.80
		✚ F	2	FJ	VP15TF	20–40	0.07–0.20	0.10–1.00
		✚ L	1	LS(M)	MP9025	20–30	0.10–0.25	0.20–0.80
		✚ L	2	MJ(G)	VP15TF	20–35	0.07–0.25	0.40–1.50
		✚ M	1	MS	MP9025	20–30	0.15–0.30	0.50–3.00
		✚ M	2	MA	MP9025	20–30	0.10–0.30	0.50–3.00
		✚ M	3	MS	VP15TF	20–35	0.15–0.30	0.50–3.00
		✚ R	1	RS	MP9025	15–25	0.20–0.35	1.00–4.00
		✚ R	2	GJ	VP15TF	15–30	0.16–0.35	1.00–3.00

WSP DREHEN

A

SCHNITTDATENEMPFEHLUNGEN : ● : Stabile Bearbeitung ● : Allgemeine Bearbeitung ✚ : Instabile Bearbeitung

ANWENDUNGSBEREICH : F : Schlichtzerspannung L : Leichtzerspannung M : Mittlere Zerspannung R : Schrupperspannung H : Schwerzerspannung

7° POSITIVE WSP

Material	Härte	Schnittmodus	Priorität	Spanbrecher	Sorte	Schnittgeschw. (m/min)	Vorschub (mm/U.)	Schnitttiefe (mm)	
Allg. Baustahl (St37-2, Ck10)	≤180HB	●	F	1	FP	NX2525	225–320	0.04–0.20	0.20–0.90
		●	F	2	FV	NX2525	225–320	0.04–0.20	0.20–0.90
		●	F	3	R/L-F	MP3025	230–355	0.05–0.12	0.10–0.50
		●	L	1	LP	NX2525	225–320	0.06–0.25	0.20–1.00
		●	L	2	Std	UE6110	210–355	0.08–0.30	0.30–2.00
		●	L	3	MV	MP3025	190–295	0.08–0.30	0.30–2.00
		●	L	4	Std	MP3025	190–295	0.08–0.30	0.30–2.00
		●	M	1	MP	NX2525	185–270	0.08–0.30	0.30–2.00
		●	F	1	FP	MC6015	250–425	0.04–0.20	0.20–0.90
		●	F	2	FP	UE6110	250–425	0.04–0.20	0.20–0.90
		●	F	3	FP	MP3025	230–355	0.04–0.20	0.20–0.90
		●	F	4	FV	MP3025	230–355	0.04–0.20	0.20–0.90
		●	F	5	FV	NX3035	220–310	0.04–0.20	0.20–0.90
		●	L	1	LP	MC6015	250–425	0.06–0.25	0.20–1.00
		●	L	2	LP	UE6110	250–425	0.06–0.25	0.20–1.00
		●	L	3	LP	MP3025	230–355	0.06–0.25	0.20–1.00
		●	L	4	Std	UE6110	210–355	0.08–0.30	0.30–2.00
		●	L	5	SW	MC6015	250–425	0.06–0.24	0.20–1.50
		●	L	6	SW	MP3025	230–355	0.06–0.24	0.20–1.50
		●	M	1	MP	MC6015	210–355	0.08–0.30	0.30–2.00
		●	M	2	MP	UE6110	210–355	0.08–0.30	0.30–2.00
		●	M	3	MP	MP3025	190–295	0.08–0.30	0.30–2.00
		●	M	4	MW	MC6015	210–355	0.10–0.35	0.80–2.50
		⊕	F	1	FP	MC6025	250–405	0.04–0.20	0.20–0.90
		⊕	L	1	LP	MC6025	250–405	0.06–0.25	0.20–1.00
		⊕	L	2	SV	MC6025	250–405	0.06–0.25	0.20–1.00
		⊕	L	3	SW	MC6025	250–405	0.06–0.24	0.20–1.50
		⊕	M	1	MP	MC6025	210–340	0.08–0.30	0.30–2.00
		⊕	M	2	MW	MC6025	210–340	0.10–0.35	0.80–2.50
		C-Stahl Leg. Stahl (Ck45, 42CrMo4)	180   280HB	●	F	1	FP	NX2525	165–240
●	F			2	FV	NX2525	165–240	0.04–0.20	0.20–0.90
●	F			3	R/L-F	MP3025	170–260	0.05–0.12	0.10–0.50
●	L			1	LP	NX2525	165–240	0.06–0.25	0.20–1.00
●	L			2	Std	UE6110	155–260	0.08–0.30	0.30–2.00
●	L			3	MV	MP3025	140–220	0.08–0.30	0.30–2.00
●	L			4	Std	MP3025	140–220	0.08–0.30	0.30–2.00
●	L			5	SV	MP3025	170–260	0.06–0.25	0.20–1.00
●	L			6	SW	MP3025	170–260	0.06–0.24	0.20–1.50
●	M			1	MP	NX2525	140–200	0.08–0.30	0.30–2.00
●	M			2	MW	MP3025	140–220	0.10–0.35	0.80–2.50
●	F			1	FP	MC6015	185–315	0.04–0.20	0.20–0.90
●	F			2	FP	UE6110	185–315	0.04–0.20	0.20–0.90
●	F			3	FP	MP3025	170–260	0.04–0.20	0.20–0.90
●	F			4	FV	MP3025	170–260	0.04–0.20	0.20–0.90
●	F			5	FV	NX3035	160–230	0.04–0.20	0.20–0.90
●	L			1	LP	MC6015	185–315	0.06–0.25	0.20–1.00

A  
WSP DREHEN

P

## SCHNITTDATENEMPFEHLUNGEN

■ 7° POSITIVE WSP

Spanbrecher : Std : Standard Flat : Glatt

Material	Härte	Schnittmodus		Priorität	Spanbrecher	Sorte	Schnittgeschw. (m/min)	Vorschub (mm/U.)	Schnittiefe (mm)
		Symbol	Spannung						
C-Stahl Leg. Stahl (Ck45, 42CrMo4)	180   280HB	●	L	2	LP	UE6110	185–315	0.06–0.25	0.20–1.00
		●	L	3	LP	MP3025	170–260	0.06–0.25	0.20–1.00
		●	L	4	Std	UE6110	155–260	0.08–0.30	0.30–2.00
		●	L	5	SW	MC6015	185–315	0.06–0.24	0.20–1.50
		●	L	6	SW	MP3025	170–260	0.06–0.24	0.20–1.50
		●	M	1	MP	MC6015	155–260	0.08–0.30	0.30–2.00
		●	M	2	MP	UE6110	155–260	0.08–0.30	0.30–2.00
		●	M	3	MP	MP3025	140–220	0.08–0.30	0.30–2.00
		●	M	4	MW	MC6015	155–260	0.10–0.35	0.80–2.50
		⚡	F	1	FP	MC6025	185–300	0.04–0.20	0.20–0.90
		⚡	L	1	LP	MC6025	185–300	0.06–0.25	0.20–1.00
		⚡	L	2	SV	MC6025	185–300	0.06–0.25	0.20–1.00
		⚡	L	3	SW	MC6025	185–300	0.06–0.24	0.20–1.50
		⚡	M	1	MP	MC6025	155–250	0.08–0.30	0.30–2.00
		⚡	M	2	MW	MC6025	155–250	0.10–0.35	0.80–2.50
C-Stahl Leg. Stahl (40CrNiMoA)	280   350HB	●	M	1	MP	NX2525	95–140	0.08–0.30	0.30–2.00
		●	M	1	MP	MC6015	110–185	0.08–0.30	0.30–2.00
		●	M	2	MP	UE6110	110–185	0.08–0.30	0.30–2.00
		●	M	3	MP	MP3025	100–155	0.08–0.30	0.30–2.00
		⚡	M	1	MP	MC6025	110–175	0.08–0.30	0.30–2.00

A

WSP DREHEN

P

SCHNITTDATENEMPFEHLUNGEN : ● : Stabile Bearbeitung ● : Allgemeine Bearbeitung ⚡ : Instabile Bearbeitung

ANWENDUNGSBEREICH : F : Schlichtzerspannung L : Leichtzerspannung M : Mittlere Zerspannung R : Schruppzerspannung H : Schwerzerspannung

Material	Härte	Schnittmodus		Priorität	Spanbrecher	Sorte	Schnittgeschw. (m/min)	Vorschub (mm/U.)	Schnitttiefe (mm)
		Symbol	Form						
Rostfreier Stahl (austenitisch) (X5CrNi189, X5CrNiMo1810)	≤200HB	●	F	1	FM	VP15TF	75–125	0.04–0.20	0.20–0.90
		●	F	2	Std	US735	70–135	0.08–0.30	0.30–2.00
		●	L	1	LM	MC7025	140–190	0.06–0.25	0.20–1.00
		●	L	2	Std	US735	70–135	0.08–0.30	0.30–2.00
		●	M	1	MM	MC7025	120–160	0.08–0.30	0.30–2.00
		●	F	1	FM	VP15TF	75–125	0.04–0.20	0.20–0.90
		●	F	2	Std	US735	70–135	0.08–0.30	0.30–2.00
		●	L	1	LM	MC7025	140–190	0.06–0.25	0.20–1.00
		●	L	2	Std	US735	70–135	0.08–0.30	0.30–2.00
		●	M	1	MM	MC7025	120–160	0.08–0.30	0.30–2.00
		⊕	F	1	FM	VP15TF	75–125	0.04–0.20	0.20–0.90
		⊕	F	2	Std	US735	70–135	0.08–0.30	0.30–2.00
		⊕	L	1	LM	MP7035	85–135	0.06–0.25	0.20–1.00
		⊕	L	2	LM	VP15TF	75–125	0.06–0.25	0.20–1.00
		⊕	L	3	Std	US735	70–135	0.08–0.30	0.30–2.00
		⊕	M	1	MM	MP7035	70–115	0.08–0.30	0.30–2.00
⊕	M	2	MM	VP15TF	60–105	0.08–0.30	0.30–2.00		
Rostfreier Stahl (austenitisch) (X2CrNiN1810, X2CrNiMoN1813)	>200HB	●	F	1	FM	VP15TF	60–105	0.04–0.20	0.20–0.90
		●	F	2	Std	US735	60–110	0.08–0.30	0.30–2.00
		●	L	1	LM	MC7025	120–160	0.06–0.25	0.20–1.00
		●	L	2	Std	US735	60–110	0.08–0.30	0.30–2.00
		●	M	1	MM	MC7025	100–130	0.08–0.30	0.30–2.00
		●	F	1	FM	VP15TF	60–105	0.04–0.20	0.20–0.90
		●	F	2	Std	US735	60–110	0.08–0.30	0.30–2.00
		●	L	1	LM	MC7025	120–160	0.06–0.25	0.20–1.00
		●	L	2	Std	US735	60–110	0.08–0.30	0.30–2.00
		●	M	1	MM	MC7025	100–130	0.08–0.30	0.30–2.00
		⊕	F	1	FM	VP15TF	60–105	0.04–0.20	0.20–0.90
		⊕	F	2	Std	US735	60–110	0.08–0.30	0.30–2.00
		⊕	L	1	LM	MP7035	70–115	0.06–0.25	0.20–1.00
		⊕	L	2	LM	VP15TF	60–105	0.06–0.25	0.20–1.00
		⊕	L	3	Std	US735	60–110	0.08–0.30	0.30–2.00
		⊕	M	1	MM	MP7035	60–95	0.08–0.30	0.30–2.00
⊕	M	2	MM	VP15TF	50–90	0.08–0.30	0.30–2.00		
Duplex, rostfreier Stahl (X3CrNiCu1894)	≤280HB	●	F	1	FM	VP15TF	50–85	0.04–0.20	0.20–0.90
		●	F	2	Std	US735	45–90	0.08–0.30	0.30–2.00
		●	L	1	LM	MC7025	95–130	0.06–0.25	0.20–1.00
		●	L	2	Std	US735	45–90	0.08–0.30	0.30–2.00
		●	M	1	MM	MC7025	80–105	0.08–0.30	0.30–2.00
		●	F	1	FM	VP15TF	50–85	0.04–0.20	0.20–0.90
		●	F	2	Std	US735	45–90	0.08–0.30	0.30–2.00
		●	L	1	LM	MC7025	95–130	0.06–0.25	0.20–1.00
		●	L	2	Std	US735	45–90	0.08–0.30	0.30–2.00
		●	M	1	MM	MC7025	80–105	0.08–0.30	0.30–2.00
		⊕	F	1	FM	VP15TF	50–85	0.04–0.20	0.20–0.90
		⊕	F	2	Std	US735	45–90	0.08–0.30	0.30–2.00
		⊕	L	1	LM	MP7035	55–90	0.06–0.25	0.20–1.00
		⊕	L	2	LM	VP15TF	50–85	0.06–0.25	0.20–1.00

A  
WSP DREHEN

## SCHNITTDATENEMPFEHLUNGEN

7° POSITIVE WSP

Spanbrecher : Std : Standard Flat : Glatt

Material	Härte	Schnittmodus		Priorität	Spanbrecher	Sorte	Schnittgeschw. (m/min)	Vorschub (mm/U.)	Schnitttiefe (mm)
		Symbol	Spannung						
Duplex, rostfreier Stahl (X3CrNiCu1894)	≤280HB	✚	L	3	Std	US735	45–90	0.08–0.30	0.30–2.00
		✚	M	1	MM	MP7035	45–75	0.08–0.30	0.30–2.00
		✚	M	2	MM	VP15TF	40–70	0.08–0.30	0.30–2.00
Rostfreie Stähle, austenitisch und martensitisch (X10Cr13, X8Cr17)	≤200HB	●	F	1	FM	VP15TF	75–125	0.04–0.20	0.20–0.90
		●	F	2	Std	US735	70–135	0.08–0.30	0.30–2.00
		●	L	1	LM	MC7025	140–190	0.06–0.25	0.20–1.00
		●	L	2	Std	US735	70–135	0.08–0.30	0.30–2.00
		●	M	1	MM	MC7025	120–160	0.08–0.30	0.30–2.00
		●	F	1	FM	VP15TF	75–125	0.04–0.20	0.20–0.90
		●	F	2	Std	US735	70–135	0.08–0.30	0.30–2.00
		●	L	1	LM	MC7025	140–190	0.06–0.25	0.20–1.00
		●	L	2	Std	US735	70–135	0.08–0.30	0.30–2.00
		●	M	1	MM	MC7025	120–160	0.08–0.30	0.30–2.00
		✚	F	1	FM	VP15TF	75–125	0.04–0.20	0.20–0.90
		✚	F	2	Std	US735	70–135	0.08–0.30	0.30–2.00
		✚	L	1	LM	MP7035	85–135	0.06–0.25	0.20–1.00
		✚	L	2	LM	VP15TF	75–125	0.06–0.25	0.20–1.00
		✚	L	3	Std	US735	70–135	0.08–0.30	0.30–2.00
		✚	M	1	MM	MP7035	70–115	0.08–0.30	0.30–2.00
✚	M	2	MM	VP15TF	60–105	0.08–0.30	0.30–2.00		
Rostfreie Stähle, austenitisch und martensitisch (X17CrNi162, X30Cr13)	>200HB	●	F	1	FM	VP15TF	60–105	0.04–0.20	0.20–0.90
		●	F	2	Std	US735	60–110	0.08–0.30	0.30–2.00
		●	L	1	LM	MC7025	120–160	0.06–0.25	0.20–1.00
		●	L	2	Std	US735	60–110	0.08–0.30	0.30–2.00
		●	M	1	MM	MC7025	100–130	0.08–0.30	0.30–2.00
		●	F	1	FM	VP15TF	60–105	0.04–0.20	0.20–0.90
		●	F	2	Std	US735	60–110	0.08–0.30	0.30–2.00
		●	L	1	LM	MC7025	120–160	0.06–0.25	0.20–1.00
		●	L	2	Std	US735	60–110	0.08–0.30	0.30–2.00
		●	M	1	MM	MC7025	100–130	0.08–0.30	0.30–2.00
		✚	F	1	FM	VP15TF	60–105	0.04–0.20	0.20–0.90
		✚	F	2	Std	US735	60–110	0.08–0.30	0.30–2.00
		✚	L	1	LM	MP7035	70–115	0.06–0.25	0.20–1.00
		✚	L	2	LM	VP15TF	60–105	0.06–0.25	0.20–1.00
		✚	L	3	Std	US735	60–110	0.08–0.30	0.30–2.00
		✚	M	1	MM	MP7035	60–95	0.08–0.30	0.30–2.00
✚	M	2	MM	VP15TF	50–90	0.08–0.30	0.30–2.00		
Gehärtete rostfreie PH-Stähle (X5CrNiCuNb16-4, X7CrNiAl17-7)	<450HB	●	F	1	FM	VP15TF	40–70	0.04–0.20	0.20–0.90
		●	F	2	FS	MP9005	110–150	0.04–0.12	0.20–1.40
		●	F	3	Std	US735	40–75	0.08–0.25	0.30–2.00
		●	L	1	LM	MC7025	75–95	0.06–0.20	0.20–1.00
		●	L	2	LS(G)	MP9015	105–140	0.04–0.15	0.30–3.00
		●	L	3	LS(M)	MP9015	105–140	0.06–0.20	0.20–1.00
		●	L	4	Std	US735	40–75	0.08–0.25	0.30–2.00
		●	M	1	MM	MC7025	60–80	0.08–0.25	0.30–2.00
		●	M	2	MS	MP9015	85–120	0.08–0.25	0.30–2.00
		●	M	3	RCMT-Std	MP9015	85–120	0.25–0.45	1.50–3.00
		●	F	1	FM	VP15TF	40–70	0.04–0.20	0.20–0.90

SCHNITTDATENEMPFEHLUNGEN : ● : Stabile Bearbeitung ● : Allgemeine Bearbeitung ✚ : Instabile Bearbeitung

ANWENDBEREICH : F : Schlichtzerspannung L : Leichtzerspannung M : Mittlere Zerspannung R : Schrappzerspannung H : Schwerzerspannung



Material	Härte	Schnittmodus		Priorität	Spanbrecher	Sorte	Schnittgeschw. (m/min)	Vorschub (mm/U.)	Schnitttiefe (mm)
M Gehärtete rostfreie PH-Stähle (X5CrNiCuNb16-4, X7CrNiAl17-7)	<450HB	☉	F	2	FS	MP9015	105–140	0.04–0.12	0.20–1.40
		☉	F	3	Std	US735	40–75	0.08–0.25	0.30–2.00
		☉	L	1	LM	MC7025	75–95	0.06–0.20	0.20–1.00
		☉	L	2	LS(G)	MP9015	105–140	0.04–0.15	0.30–3.00
		☉	L	3	LS(M)	MP9015	105–140	0.06–0.20	0.20–1.00
		☉	L	4	Std	US735	40–75	0.08–0.25	0.30–2.00
		☉	M	1	MM	MC7025	60–80	0.08–0.25	0.30–2.00
		☉	M	2	MS	MP9015	85–120	0.08–0.25	0.30–2.00
		☉	M	3	RCMT-Std	MP9015	85–120	0.25–0.45	1.50–3.00
		☼	F	1	FM	VP15TF	40–70	0.04–0.20	0.20–0.90
		☼	F	2	Std	US735	40–75	0.08–0.25	0.30–2.00
		☼	L	1	LM	MP7035	45–75	0.06–0.20	0.20–1.00
		☼	L	2	LS(M)	MP9025	70–85	0.06–0.20	0.20–1.00
		☼	L	3	LM	VP15TF	40–70	0.06–0.20	0.20–1.00
		☼	L	4	Std	US735	40–75	0.08–0.25	0.30–2.00
		☼	M	1	MM	MP7035	40–60	0.08–0.25	0.30–2.00
		☼	M	2	MS	MP9025	60–70	0.08–0.25	0.30–2.00
		☼	M	3	MM	VP15TF	35–60	0.08–0.25	0.30–2.00
		☼	M	4	RCMT-Std	MP9025	60–70	0.25–0.45	1.50–3.00

A

WSP DREHEN

## SCHNITTDATENEMPFEHLUNGEN

■ 7° POSITIVE WSP

Spanbrecher : Std : Standard Flat : Glatt

Material	Zugfestigkeit	Schnittmodus		Priorität	Spanbrecher	Sorte	Schnittgeschw. (m/min)	Vorschub (mm/U.)	Schnittiefe (mm)
		●	F						
Grauguss (GG30)	≤350MPa	●	F	1	MK	MC5005	165–265	0.08–0.30	0.30–2.00
		●	L	1	MK	MC5005	165–265	0.08–0.30	0.30–2.00
		●	M	1	Flat	MC5005	165–265	0.08–0.30	0.30–2.00
		●	F	1	MK	MC5015	150–240	0.08–0.30	0.30–2.00
		●	L	1	MK	MC5015	150–240	0.08–0.30	0.30–2.00
		●	M	1	Flat	MC5015	150–240	0.08–0.30	0.30–2.00
		✚	F	1	MK	MC5015	150–240	0.08–0.30	0.30–2.00
		✚	L	1	MK	MC5015	150–240	0.08–0.30	0.30–2.00
		✚	M	1	Flat	MC5015	150–240	0.08–0.30	0.30–2.00
Duktiler Guss (GGG40)	≤450MPa	●	F	1	MK	MC5005	155–250	0.08–0.30	0.30–2.00
		●	L	1	MK	MC5005	155–250	0.08–0.30	0.30–2.00
		●	M	1	Flat	MC5005	155–250	0.08–0.30	0.30–2.00
		●	F	1	MK	MC5015	140–230	0.08–0.30	0.30–2.00
		●	L	1	MK	MC5015	140–230	0.08–0.30	0.30–2.00
		●	M	1	Flat	MC5015	140–230	0.08–0.30	0.30–2.00
		✚	F	1	MK	MC5015	140–230	0.08–0.30	0.30–2.00
		✚	L	1	MK	MC5015	140–230	0.08–0.30	0.30–2.00
		✚	M	1	Flat	MC5015	140–230	0.08–0.30	0.30–2.00
Duktiler Guss (GGG70)	≤800MPa	●	F	1	MK	MC5005	140–225	0.08–0.30	0.30–2.00
		●	L	1	MK	MC5005	140–225	0.08–0.30	0.30–2.00
		●	M	1	Flat	MC5005	140–225	0.08–0.30	0.30–2.00
		●	F	1	MK	MC5015	125–205	0.08–0.30	0.30–2.00
		●	L	1	MK	MC5015	125–205	0.08–0.30	0.30–2.00
		●	M	1	Flat	MC5015	125–205	0.08–0.30	0.30–2.00
		✚	F	1	MK	MC5015	125–205	0.08–0.30	0.30–2.00
		✚	L	1	MK	MC5015	125–205	0.08–0.30	0.30–2.00
		✚	M	1	Flat	MC5015	125–205	0.08–0.30	0.30–2.00

WSP DREHEN

A

K

SCHNITTDATENEMPFEHLUNGEN : ● : Stabile Bearbeitung ● : Allgemeine Bearbeitung ✚ : Instabile Bearbeitung

ANWENDUNGSBEREICH : F : Schlichtzerspannung L : Leichtzerspannung M : Mittlere Zerspannung R : Schrappzerspannung H : Schwerzerspannung

Material	Härte	Schnittmodus		Priorität	Spanbrecher	Sorte	Schnittgeschw. (m/min)	Vorschub (mm/U.)	Schnitttiefe (mm)	
N	Aluminiumlegierung (A6061, A7075)	Si<5%	●	F	1	AZ	HTi10	300–700	0.10–0.40	0.20–3.00
			◐	F	1	AZ	HTi10	300–700	0.10–0.40	0.20–3.00
			⊕	F	1	AZ	HTi10	300–700	0.10–0.40	0.20–3.00
	Aluminiumlegierung (AC4B)	5%≤Si≤10%	●	F	1	AZ	HTi10	300–700	0.10–0.40	0.20–3.00
			◐	F	1	AZ	HTi10	300–700	0.10–0.40	0.20–3.00
			⊕	F	1	AZ	HTi10	300–700	0.10–0.40	0.20–3.00
	Aluminiumlegierung (ADC12, A390)	Si>10%	●	F	1	AZ	HTi10	300–700	0.10–0.40	0.20–3.00
			◐	F	1	AZ	HTi10	300–700	0.10–0.40	0.20–3.00
			⊕	F	1	AZ	HTi10	300–700	0.10–0.40	0.20–3.00

A

WSP DREHEN

## SCHNITTDATENEMPFEHLUNGEN

7° POSITIVE WSP

Spanbrecher : Std : Standard Flat : Glatt

Material	Härte	Schnittmodus		Priorität	Spanbrecher	Sorte	Schnittgeschw. (m/min)	Vorschub (mm/U.)	Schnittiefe (mm)
		Symbol	Spannung						
Titanlegierung (Ti-6Al-4V)	—	●	F	1	FS-P	MT9005	40–80	0.04–0.12	0.20–1.40
		●	F	2	FJ	RT9010	35–75	0.04–0.12	0.20–1.40
		●	L	1	LS-P	MT9005	40–80	0.04–0.15	0.30–3.00
		●	L	2	LS(M)	MT9005	40–80	0.06–0.20	0.20–1.00
		●	M	1	MS	MT9005	35–65	0.08–0.25	0.30–2.00
		●	M	2	RCMT-Std	MT9005	35–65	0.25–0.45	1.50–3.00
		●	F	1	FS-P	MT9005	40–80	0.04–0.12	0.20–1.40
		●	F	2	FJ	RT9010	35–75	0.04–0.12	0.20–1.40
		●	L	1	LS-P	MT9005	40–80	0.04–0.15	0.30–3.00
		●	L	2	LS(M)	MT9005	40–80	0.06–0.20	0.20–1.00
		●	M	1	MS	MT9005	35–65	0.08–0.25	0.30–2.00
		●	M	2	RCMT-Std	MT9005	35–65	0.25–0.45	1.50–3.00
		⊕	F	1	FS-P	MT9005	40–80	0.04–0.12	0.20–1.40
		⊕	F	2	FJ	RT9010	35–75	0.04–0.12	0.20–1.40
		⊕	L	1	LS-P	MT9005	40–80	0.04–0.15	0.30–3.00
		⊕	L	2	LS(M)	MT9005	40–80	0.06–0.20	0.20–1.00
		⊕	M	1	MS	MT9005	35–65	0.08–0.25	0.30–2.00
		⊕	M	2	RCMT-Std	MT9015	30–60	0.25–0.45	1.50–3.00
Hitzebeständiger Stahl (Inconel718)	—	●	F	1	FS	MP9005	25–95	0.04–0.12	0.20–1.40
		●	F	2	FJ	VP10RT	20–45	0.04–0.12	0.20–1.40
		●	L	1	LS(G)	MP9005	25–95	0.04–0.15	0.30–3.00
		●	L	2	LS(M)	MP9005	25–95	0.06–0.20	0.20–1.00
		●	M	1	MS	MP9005	20–80	0.08–0.25	0.30–2.00
		●	M	2	RCMT-Std	MP9005	20–80	0.25–0.45	1.50–3.00
		●	F	1	FS	MP9015	20–75	0.04–0.12	0.20–1.40
		●	F	2	FJ	VP10RT	20–45	0.04–0.12	0.20–1.40
		●	L	1	LS(G)	MP9015	20–75	0.04–0.15	0.30–3.00
		●	L	2	LS(M)	MP9015	20–75	0.06–0.20	0.20–1.00
		●	M	1	MS	MP9015	20–60	0.08–0.25	0.30–2.00
		●	M	2	RCMT-Std	MP9015	20–60	0.25–0.45	1.50–3.00
		⊕	F	1	FJ	VP10RT	20–45	0.04–0.12	0.20–1.40
		⊕	L	1	LS(M)	MP9025	15–25	0.06–0.20	0.20–1.00
		⊕	M	1	MS	MP9025	15–20	0.08–0.25	0.30–2.00
		⊕	M	2	RCMT-Std	MP9025	15–20	0.25–0.45	1.50–3.00

A

WSP DREHEN

S

SCHNITTDATENEMPFEHLUNGEN : ● : Stabile Bearbeitung ● : Allgemeine Bearbeitung ⊕ : Instabile Bearbeitung

ANWENDUNGSBEREICH : F : Schlichtzerspannung L : Leichtzerspannung M : Mittlere Zerspannung R : Schrumpferspannung H : Schwerzerspannung

■ 11° POSITIVE WSP

Material	Härte	Schnittmodus		Priorität	Spanbrecher	Sorte	Schnittgeschw. (m/min)	Vorschub (mm/U.)	Schnitttiefe (mm)
Allg. Baustahl (St37-2, Ck10)	≤180HB	●	F	1	R-R/L	NX2525	225–320	0.05–0.12	0.20–0.60
		●	L	1	R-Std	NX2525	185–270	0.08–0.30	0.30–2.00
		●	M	1	R-Std	NX2525	185–270	0.08–0.30	0.30–2.00
		●	F	1	R-R/L	NX2525	225–320	0.05–0.12	0.20–0.60
		●	L	1	R-Std	UE6110	210–355	0.08–0.30	0.30–2.00
		●	L	2	R-Std	MP3025	190–295	0.08–0.30	0.30–2.00
		●	L	3	R-Std	NX3035	180–255	0.08–0.30	0.30–2.00
		●	M	1	R-Std	UE6110	210–355	0.08–0.30	0.30–2.00
		●	M	2	R-Std	MP3025	190–295	0.08–0.30	0.30–2.00
		●	M	3	R-Std	NX3035	180–255	0.08–0.30	0.30–2.00
		⊕	F	1	R-R/L	UTi20T	115–165	0.05–0.12	0.20–0.60
		⊕	L	1	N-Flat	UP20M	105–160	0.08–0.30	0.30–2.00
		⊕	M	1	N-Flat	UP20M	105–160	0.08–0.30	0.30–2.00
		C-Stahl Leg. Stahl (Ck45, 42CrMo4)	180   280HB	●	F	1	R-R/L	NX2525	165–240
●	L			1	R-Std	NX2525	140–200	0.08–0.30	0.30–2.00
●	M			1	R-Std	NX2525	140–200	0.08–0.30	0.30–2.00
●	F			1	R-R/L	NX2525	165–240	0.05–0.12	0.20–0.60
●	L			1	R-Std	UE6110	155–260	0.08–0.30	0.30–2.00
●	L			2	R-Std	MP3025	140–220	0.08–0.30	0.30–2.00
●	L			3	R-Std	NX3035	135–190	0.08–0.30	0.30–2.00
●	M			1	R-Std	UE6110	155–260	0.08–0.30	0.30–2.00
●	M			2	R-Std	MP3025	140–220	0.08–0.30	0.30–2.00
●	M			3	R-Std	NX3035	135–190	0.08–0.30	0.30–2.00
⊕	F			1	R-R/L	UTi20T	85–120	0.05–0.12	0.20–0.60
⊕	L			1	N-Flat	UP20M	80–120	0.08–0.30	0.30–2.00
⊕	M			1	N-Flat	UP20M	80–120	0.08–0.30	0.30–2.00

P

A

WSP DREHEN

## SCHNITTDATENEMPFEHLUNGEN

■ 11° POSITIVE WSP

Spanbrecher : Std : Standard Flat : Glatt

Material	Zugfestigkeit	Schnittmodus		Priorität	Spanbrecher	Sorte	Schnittgeschw. (m/min)	Vorschub (mm/U.)	Schnitttiefe (mm)
		●	F						
Grauguss (GG30)	≤350MPa	●	F	1	R-R/L	NX2525	145–200	0.05–0.12	0.20–0.60
		●	L	1	N-Flat	MC5005	165–265	0.08–0.30	0.30–2.00
		●	L	2	N-Flat	NX2525	120–165	0.08–0.30	0.30–2.00
		●	L	3	R-Std	NX2525	120–165	0.08–0.30	0.30–2.00
		●	M	1	N-Flat	MC5005	165–265	0.08–0.30	0.30–2.00
		●	M	2	N-Flat	NX2525	120–165	0.08–0.30	0.30–2.00
		●	M	3	R-Std	NX2525	120–165	0.08–0.30	0.30–2.00
		●	F	1	R-R/L	NX2525	145–200	0.05–0.12	0.20–0.60
		●	F	2	R-R/L	HTi10	100–140	0.05–0.12	0.20–0.60
		●	L	1	N-Flat	MC5015	150–240	0.08–0.30	0.30–2.00
		●	L	2	N-Flat	UE6110	125–200	0.08–0.30	0.30–2.00
		●	M	1	N-Flat	MC5015	150–240	0.08–0.30	0.30–2.00
		●	M	2	N-Flat	UE6110	125–200	0.08–0.30	0.30–2.00
		✚	F	1	R-R/L	UTi20T	80–115	0.05–0.12	0.20–0.60
		✚	L	1	N-Flat	VP15TF	115–160	0.08–0.30	0.30–2.00
✚	M	1	N-Flat	VP15TF	115–160	0.08–0.30	0.30–2.00		
Duktiler Guss (GGG40)	≤450MPa	●	F	1	R-R/L	NX2525	140–190	0.05–0.12	0.20–0.60
		●	L	1	N-Flat	MC5005	155–250	0.08–0.30	0.30–2.00
		●	L	2	N-Flat	NX2525	115–155	0.08–0.30	0.30–2.00
		●	L	3	R-Std	NX2525	115–155	0.08–0.30	0.30–2.00
		●	M	1	N-Flat	MC5005	155–250	0.08–0.30	0.30–2.00
		●	M	2	N-Flat	NX2525	115–155	0.08–0.30	0.30–2.00
		●	M	3	R-Std	NX2525	115–155	0.08–0.30	0.30–2.00
		●	F	1	R-R/L	NX2525	140–190	0.05–0.12	0.20–0.60
		●	F	2	R-R/L	HTi10	95–135	0.05–0.12	0.20–0.60
		●	L	1	N-Flat	MC5015	140–230	0.08–0.30	0.30–2.00
		●	L	2	N-Flat	UE6110	120–190	0.08–0.30	0.30–2.00
		●	M	1	N-Flat	MC5015	140–230	0.08–0.30	0.30–2.00
		●	M	2	N-Flat	UE6110	120–190	0.08–0.30	0.30–2.00
		✚	F	1	R-R/L	UTi20T	75–105	0.05–0.12	0.20–0.60
		✚	L	1	N-Flat	VP15TF	110–150	0.08–0.30	0.30–2.00
✚	M	1	N-Flat	VP15TF	110–150	0.08–0.30	0.30–2.00		
Duktiler Guss (GGG70)	≤800MPa	●	F	1	R-R/L	NX2525	125–170	0.05–0.12	0.20–0.60
		●	L	1	N-Flat	MC5005	140–225	0.08–0.30	0.30–2.00
		●	L	2	N-Flat	NX2525	105–140	0.08–0.30	0.30–2.00
		●	L	3	R-Std	NX2525	105–140	0.08–0.30	0.30–2.00
		●	M	1	N-Flat	MC5005	140–225	0.08–0.30	0.30–2.00
		●	M	2	N-Flat	NX2525	105–140	0.08–0.30	0.30–2.00
		●	M	3	R-Std	NX2525	105–140	0.08–0.30	0.30–2.00
		●	F	1	R-R/L	NX2525	125–170	0.05–0.12	0.20–0.60
		●	F	2	R-R/L	HTi10	85–120	0.05–0.12	0.20–0.60
		●	L	1	N-Flat	MC5015	125–205	0.08–0.30	0.30–2.00
		●	L	2	N-Flat	UE6110	105–170	0.08–0.30	0.30–2.00
		●	M	1	N-Flat	MC5015	125–205	0.08–0.30	0.30–2.00
		●	M	2	N-Flat	UE6110	105–170	0.08–0.30	0.30–2.00
		✚	F	1	R-R/L	UTi20T	65–95	0.05–0.12	0.20–0.60
		✚	L	1	N-Flat	VP15TF	95–135	0.08–0.30	0.30–2.00
✚	M	1	N-Flat	VP15TF	95–135	0.08–0.30	0.30–2.00		

SCHNITTDATENEMPFEHLUNGEN : ● : Stabile Bearbeitung ● : Allgemeine Bearbeitung ✚ : Instabile Bearbeitung

ANWENDUNGSBEREICH : F : Schlichtzerspannung L : Leichtzerspannung M : Mittlere Zerspannung R : Schrumpferspannung H : Schwerzerspannung

# Notizen

---

A series of horizontal dashed lines for writing notes, spanning the width of the page.































# WSP DREHEN [NEGATIV]



## DNMG 15 04 08- RM





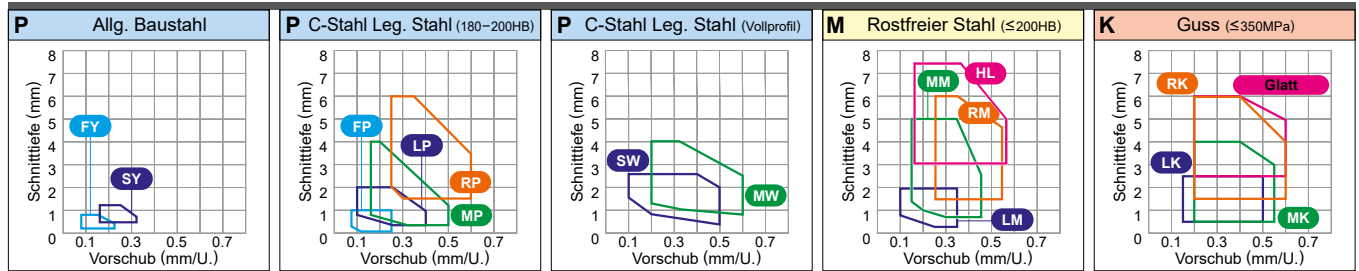

Größe Dicke Eckenradius Spanbrecher  
\* Siehe Seite A002.

### ÜBERSICHT DER SPANBRECHER FÜR DIV. MATERIALGRUPPEN

Schlichtzerspanung..... Leichtzerspanung..... Mittlere Zerspanung..... Schrupperzerspanung..... Schwerzerspanung.....



Schnittbedingungen : ● : Stabile Bearbeitung ● : Allgemeine Bearbeitung ✦ : Instabile Bearbeitung

Form	Bestellbezeichnung	RE (mm)	Beschichtet														Cermet	Besch. Cermet	Hartmetall	Zugehöriger Halter Seite																
			UE6105	UE6110	UE6020	NEW MC6115	MC6015	MC6025	MC6035	UH6400	MS6015	MC7015	MC7025	MP7035	US735	US905					MC5005	MC5015	NEW MH515	MP9005	NEW MP9015	NEW MP9025	VP05RT	VP10RT	VP15TF	UP20M	NX2525	NX3035	MP3025	AP25N	VP25N	UTi20T
 Schrupperzerspanung	DNMG150408-RM	0.8																																		C010
	DNMG150412-RM	1.2																																		C011
	DNMG150416-RM	1.6																																		E015
	DNMG150608-RM	0.8																																		E038
	DNMG150612-RM	1.2																																		-040
 Schrupperzerspanung	DNMG150408-RK	0.8																																	C010	
	DNMG150412-RK	1.2																																		C011
	DNMG150608-RK	0.8																																		E015
	DNMG150612-RK	1.2																																		E038
																																				-040
 Schrupperzerspanung	DNMG150408-RS	0.8																																	●	C010
	DNMG150412-RS	1.2																																	●	C011
	DNMG150416-RS	1.6																																	★	E015
	DNMG150608-RS	0.8																																	●	E038
	DNMG150612-RS	1.2																																	●	-040
 Schrupperzerspanung	DNMG150408-GH	0.8	★	●	★	●																													C010	
	DNMG150412-GH	1.2	★	●	★	●																														C011
	DNMG150608-GH	0.8	●	●	★	●																														E015
	DNMG150612-GH	1.2	●	●	★	●																														E038
																																				-040
 Schrupperzerspanung	DNMG150408-GJ	0.8																																	★	C010
	DNMG150412-GJ	1.2																																	★	C011
	DNMG150416-GJ	1.6																																		E015
	DNMG150608-GJ	0.8																																		E038
	DNMG150612-GJ	1.2																																		-040
 Schwerzerspanung	DNMM150408-HL	0.8																																	C010	
	DNMM150412-HL	1.2																																		C011
	DNMM150608-HL	0.8	●																																	E015
	DNMM150612-HL	1.2	●																																	E038

● = NEW

● : Lagerstandard. ★ : Lagerstandard in Japan.

□ : Herstellung nur auf Anfrage.



















Schnittbedingungen : ● : Stabile Bearbeitung ● : Allgemeine Bearbeitung ✦ : Instabile Bearbeitung

Material	P Stahl	M Rostfreier Stahl	K Guss	N Nicht-Eisen-Metalle	S Hitzebeständige Legierungen, Titanlegierungen	Schnittbedingungen																															
						UE6105	UE6110	UE6020	MC6115	MC6015	MC6025	MC6035	UH6400	MS6015	MC7015	MC7025	MP7035	US735	US905	MC5005	MC5015	MH515	MP9005	MP9015	MP9025	VP05RT	VP10RT	VP15TF	UP20M	NX2525	NX3035	MP3025	AP25N	VP25N	UTi20T	HT110	RT9010
Form	Bestellbezeichnung	RE (mm)	Beschichtet																				Cermet	Besch. Cermet	Hartmetall	Zugehöriger Halter Seite											
<b>MS</b> 	SNMG090304-MS	0.4																																			
	SNMG090308-MS	0.8																																			
	SNMG120404-MS	0.4	★																																		
	SNMG120408-MS	0.8	●																																		
	SNMG120412-MS	1.2	★																																		
	SNMG120416-MS	1.6																																			
Mittlere Zerspanung	SNMG190616-MS	1.6																																			
<b>GK</b> 	SNMG120404-GK	0.4																																			
	SNMG120408-GK	0.8																																			
	SNMG120412-GK	1.2																																			
Mittlere Zerspanung																																					
<b>GM</b> 	SNMG120404-GM	0.4																																			
	SNMG120408-GM	0.8																																			
	SNMG120412-GM	1.2																																			
Mittlere Zerspanung																																					
<b>MA</b> 	SNMG120404-MA	0.4	★ ●	● ●																																	
	SNMG120408-MA	0.8	● ●	● ●																																	
	SNMG120412-MA	1.2	● ●	● ●																																	
	SNMG120416-MA	1.6																																			
	SNMG150608-MA	0.8	★ ●	★ ●																																	
	SNMG150612-MA	1.2	★ ●	● ●																																	
	SNMG150616-MA	1.6	★																																		
Mittlere Zerspanung	SNMG190612-MA	1.2	★ ●	● ●																																	
SNMG190616-MA	1.6	★ ★	● ●																																		
<b>MH</b> 	SNMG120408-MH	0.8	★ ●	● ●																																	
	SNMG120412-MH	1.2	★ ●	● ●																																	
	SNMG190612-MH	1.2	★ ●	★ ●																																	
	SNMG190616-MH	1.6	● ★	★ ●																																	
Mittlere Zerspanung																																					
<b>Standard</b> 	SNMG090304	0.4	★ ★																																		
	SNMG090308	0.8	★ ●																																		
	SNMG120404	0.4	★ ●	● ●																																	
	SNMG120408	0.8	★ ●	● ●																																	
	SNMG120412	1.2	★ ●	● ●																																	
	SNMG120416	1.6	★																																		
	SNMG120420	2.0																																			
	SNMG150612	1.2	★ ★	● ●																																	
	SNMG150616	1.6																																			
	SNMG190612	1.2	● ★	● ●																																	
	SNMG190616	1.6	★ ●	● ●																																	

● = NEW

A

WSP DREHEN

NEG

MIT LOCH

C

D

R

S

T

V

W

SPANBRECHER > A042  
SORTEN > A030  
IDENTIFIKATION > A002

A115

# WSP DREHEN [NEGATIV]

90° **SN** AUSFÜHRUNG WSP MIT LOCH

**SNGG 09 03 04 R**



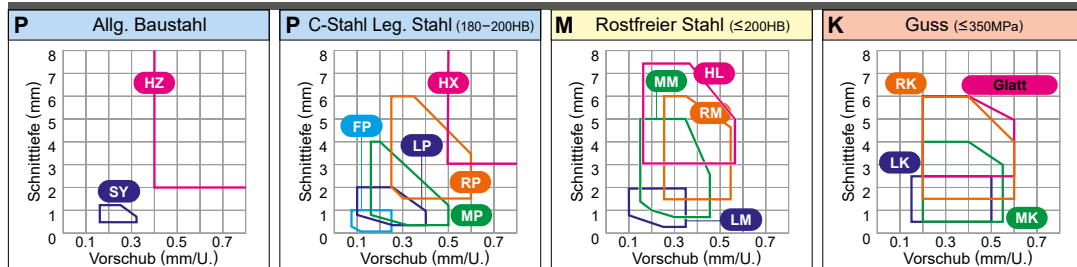

Größe Dicke Eckenradius R/L  
\* Siehe Seite A002.

## ÜBERSICHT DER SPANBRECHER FÜR DIV. MATERIALGRUPPEN

Schlichtzerspannung..... Leichtzerspannung..... Mittlere Zerspannung..... Schruppzerspannung..... Schwerzerspannung.....



Schnittbedingungen : ● : Stabile Bearbeitung ● : Allgemeine Bearbeitung ✦ : Instabile Bearbeitung

Form	Bestellbezeichnung	RE (mm)	Beschichtet																Cermet	Besch. Cermet	Hartmetall	Zugehöriger Halter Seite													
			UE6105	UE6110	UE620	<b>NEW</b> MC6115	MC6015	MC6025	MC6035	UH6400	MS6015	MC7015	MC7025	MP7035	US735	US905	MC5005	MC5015					<b>NEW</b> MH515	<b>NEW</b> MP9005	<b>NEW</b> MP9025	VP05RT	VP10RT	VP15TF	UP20M	NX2525	NX3035	MP3025	AP25N	VP25N	UT120T
R/L 	SNGG090304R	0.4	●	●	●	●	●	●	●	●	●	●	●	●	●	●	●	●	●	●	●	●	●	●	●	●	●	●	●	●	●	●	●	●	
	SNGG090304L	0.4	●	●	●	●	●	●	●	●	●	●	●	●	●	●	●	●	●	●	●	●	●	●	●	●	●	●	●	●	●	●	●	●	
	SNGG090308R	0.8																																	
	SNGG090308L	0.8																																	
	SNGG120404R	0.4																																	
	SNGG120404L	0.4																																	
	SNGG120408R	0.8																																	
Mittlere Zerspannung	SNGG120408L	0.8																																	
RP 	SNMG120408-RP	0.8	★	★	●	●	●	●	●																										
	SNMG120412-RP	1.2	★	●	●	●	●	●	●																										
	SNMG120416-RP	1.6	★	★	●	●	●	●	●																										
	SNMG150612-RP	1.2	★	★	●	●	●	●	●																										
	SNMG150616-RP	1.6	●	★	●	●	●	●	●																										
	Schruppzerspannung	SNMG190612-RP	1.2	★	★	●	●	●	●	●																									
RM 	SNMG120408-RM	0.8								★	●	●																							
	SNMG120412-RM	1.2								★	●	●																							
	SNMG120416-RM	1.6								★	★	●																							
	SNMG150612-RM	1.2								●	★	●																							
	SNMG150616-RM	1.6								★	★	★																							
	Schruppzerspannung	SNMG190612-RM	1.2								★	●	★																						
RM	SNMG190616-RM	1.6								●	●	●																							
	SNMG120408-RK	0.8								●	●																								
	SNMG120412-RK	1.2								●	●																								
	SNMG120416-RK	1.6								●	●																								
	SNMG150612-RK	1.2								★	●																								
	Schruppzerspannung	SNMG190612-RK	1.2							★	●																								
RK 	SNMG190616-RK	1.6								★	●																								
	SNMG120408-RS	0.8																	●	●															
	SNMG120412-RS	1.2																	●	●															
	SNMG120416-RS	1.6																	★	●															
	SNMG150616-RS	1.6																	●	●															
	Schruppzerspannung	SNMG190612-RS	1.2																●	●															
RS 	SNMG190616-RS	1.6																●	●																
	SNMG120408-RS	0.8																																	
	SNMG120412-RS	1.2																																	
	Schruppzerspannung	SNMG190616-RS	1.6																●	●															

● = NEW

● : Lagerstandard. ★ : Lagerstandard in Japan.  
□ : Herstellung nur auf Anfrage.



# WSP DREHEN [NEGATIV]

# 90° SN AUSFÜHRUNG WSP MIT LOCH

## SNMM 25 07 24- HXD

Größe Dicke Eckenradius Spanbrecher  
\* Siehe Seite A002.

### ÜBERSICHT DER SPANBRECHER FÜR DIV. MATERIALGRUPPEN

Schlichtzerspannung..... Leichtzerspannung..... Mittlere Zerspannung..... Schruppzerspannung..... Schwerzerspannung.....

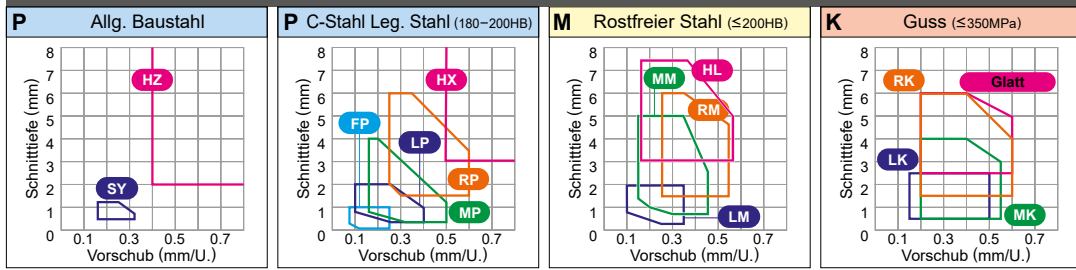

WSP DREHEN

A

Schnittbedingungen : ● : Stabile Bearbeitung ● : Allgemeine Bearbeitung ⚡ : Instabile Bearbeitung

Form	Bestellbezeichnung	RE (mm)	Beschichtet															Cermet	Besch. Cermet		Hartmetall		Zugehöriger Halter Seite																
			UE6105	UE6110	UE6020	<b>NEW</b> MC6115	MC6015	MC6025	MC6035	UH6400	MS6015	MC7015	MC7025	MP7035	US735	US905	MC5005		MC5015	<b>NEW</b> MH515	<b>NEW</b> MP9005	<b>NEW</b> MP9015		<b>NEW</b> MP9025	VP05RT	VP10RT	VP15TF	UP20M	NX2525	NX3035	MP3025	AP25N	VP25N	UT120T	HT110	RT9010	MT9015		
HXD 	SNMM250724-HXD	2.4	●																																			-	
	Glatt 	SNMA090304	0.4																																				

● = NEW

● : Lagerstandard. ★ : Lagerstandard in Japan.

### ÜBERSICHT DER SPANBRECHER FÜR DIV. MATERIALGRUPPEN

Schlichtzerspanung..... Leichtzerspanung..... Mittlere Zerspanung..... Schruppzerspanung..... Schwerzerspanung.....

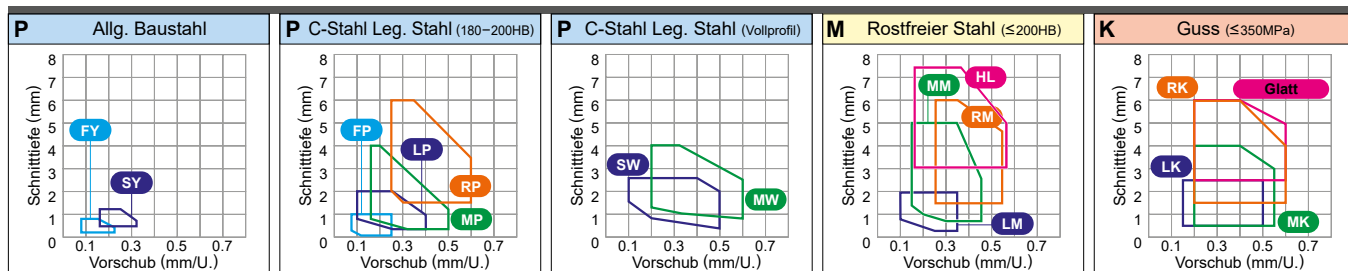

Schnittbedingungen : ● : Stabile Bearbeitung ● : Allgemeine Bearbeitung ✦ : Instabile Bearbeitung

Material	Form	Bestellbezeichnung	RE (mm)	Beschichtet		Cermet	Besch. Cermet	Hartmetall	Zugehöriger Halter Seite
				UE6105 UE6110 UE6020 NEW MC6115 MC6015 MC6025 MC6035 UH6400 MS6015 MC7015 MC7025 MP7035 US735 US905 MC5005 MC5015 NEW MH515 MP9005 NEW MP9015 NEW MP9025 VP05RT VP10RT VP15TF UP20M NX2525 NX3035	MP3025 AP25N VP25N UT120T HT110 RT9010 MT9015				
P Stahl	Schlichtzerspanung	FP 	TNMG160402-FP 0.2	★ ★					
		TNMG160404-FP 0.4	● ●					C016	
		TNMG160408-FP 0.8	● ●					-018	
		TNMG160412-FP 1.2	● ●					E016 E037	
P C-Stahl Leg. Stahl (180-200HB)	Schlichtzerspanung	FH 	TNMG110304-FH 0.4	★					
		TNMG160402-FH 0.2	●					C016	
		TNMG160404-FH 0.4	●					-018	
		TNMG160408-FH 0.8	●					E016 E037	
P C-Stahl Leg. Stahl (Vollprofil)	Schlichtzerspanung	FS 	TNMG160404-FS 0.4						
		TNMG160408-FS 0.8						C016 -018 E016 E037	
M Rostfreier Stahl (<=200HB)	Schlichtzerspanung	FY 	TNMG160404-FY 0.4	●					
		TNMG160408-FY 0.8	●					C016 -018 E016 E037	
K Guss (<=350MPa)	Schlichtzerspanung	R/L-FS 	TNGG160402R-FS 0.2	●					
		TNGG160402L-FS 0.2	●					C016	
		TNGG160404R-FS 0.4	●					-018	
		TNGG160404L-FS 0.4	●					E016	
		NEW TNGG160408R-FS 0.8	●					E037	
		NEW TNGG160408L-FS 0.8	●						
K Guss (<=350MPa)	Schlichtzerspanung	R/L-F 	TNGG160402R-F 0.2						
		TNGG160402L-F 0.2						C016	
		TNGG160404R-F 0.4						-018	
		TNGG160404L-F 0.4						E016	
		TNGG160408R-F 0.8						E037	

● = NEW

# WSP DREHEN [NEGATIV]



## TNMG 16 04 04- LP

Größe Dicke Eckenradius Spanbrecher  
\* Siehe Seite A002.

### ÜBERSICHT DER SPANBRECHER FÜR DIV. MATERIALGRUPPEN

Schlichtzerspanung..... Leichtzerspanung..... Mittlere Zerspanung..... Schruppzerspanung..... Schwerzerspanung.....

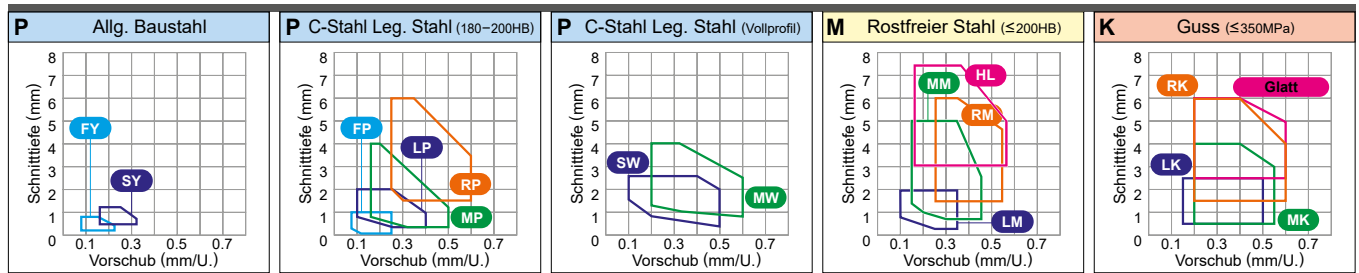

Schnittbedingungen : ● : Stabile Bearbeitung ● : Allgemeine Bearbeitung ✦ : Instabile Bearbeitung

Material	Form	Bestellbezeichnung	RE (mm)	Beschichtet															Cermet	Besch. Cermet	Hartmetall	Zugehöriger Halter Seite																						
				UE6105	UE6110	UE6020	MC6115 <sup>NEW</sup>	MC6015	MC6025	MC6035	UH6400	MS6015	MC7015	MC7025	MP7035	US735	US905	MC5005					MC5015	MH515 <sup>NEW</sup>	MP9005	MP9015	MP9025 <sup>NEW</sup>	VP05RT	VP10RT	VP15TF	UP20M	NX2525	NX3035	MP3025	AP25N	VP25N	UT120T	HT110	RT9010	MT9015				
P Allg. Baustahl	Leichtzerspanung	TNMG160404-LP	0.4	●	●	●	●	●	●																																			
		TNMG160408-LP	0.8	●	●	●	●	●	●																																			
		TNMG160412-LP	1.2	●	●	●	●	●	●																																			
		TNMG220408-LP	0.8	●	●	●	●	●	●																																			
		TNMG220412-LP	1.2	●	●	●	●	●	●																																			
M Rostfreier Stahl (<math>\le 200HB</math>)	Leichtzerspanung	TNMG160404-LM	0.4							●	●	●																																
		TNMG160408-LM	0.8							●	●	●																																
		TNMG160412-LM	1.2							●	●	●																																
K Guss (<math>\le 350MPa</math>)	Leichtzerspanung	TNMG160404-LK	0.4													●	●																											
		TNMG160408-LK	0.8													●	●																											
		TNMG160412-LK	1.2													●	●																											









\* Vor dem Einsatz des SW-Spanbrechers (Vollprofil), beachten Sie bitte Seite A028.

● = NEW

● : Lagerstandard. ★ : Lagerstandard in Japan.



Schnittbedingungen : ● : Stabile Bearbeitung ● : Allgemeine Bearbeitung ✦ : Instabile Bearbeitung

Material	P	Stahl	●●●●●●●●●●●●	●●●●●●●●●●●●																																				
	M	Rostfreier Stahl			●●●●●●●●●●																																			
K	Guss					●●●●●●●●●●																																		
N	Nicht-Eisen-Metalle						●●●●●●●●●●																																	
S	Hitzbeständige Legierungen, Titanlegierungen							●●●●●●●●●●																																
Form	Bestellbezeichnung	RE (mm)	Beschichtet													Cermet	Besch. Cermet	Hartmetall		Zugehöriger Halter Seite																				
			UE6105	UE6110	UE6020	<b>MC6115</b> NEW	MC6015	MC6025	MC6035	UH6400	MS6015	MC7015	MC7025	MP7035	US735	US905	MC5005	MC5015	<b>MH515</b> NEW		MP9005	MP9015	<b>MP9025</b> NEW	VP05RT	VP10RT	VP15TF	UP20M	NX2525	NX3035	MP3025	AP25N	VP25N	UT120T	HT110	RT9010	MT9015				
<b>SY</b> 	TNMG160404-SY	0.4	●																								★	★												
	TNMG160408-SY	0.8	●																									★	★	●									C016 -018 E016 E037	
<b>MJ</b> 	TNMG160404-MJ	0.4													●			●●	●●																				C016 -018 E016 E037	
	TNMG160408-MJ	0.8													●			●●	●●																					
	TNMG160412-MJ	1.2													●			●●	●●	★	●																			
<b>R/L-K</b> 	TNGG160402R-K	0.2																								★	★	★												
	TNGG160402L-K	0.2																									★	★	★											
	TNGG160404R-K	0.4																									★	★	●											
	TNGG160404L-K	0.4																										★	★											
	TNGG160408R-K	0.8																										★												
<b>MP</b> 	TNMG160404-MP	0.4	●●	●●	●●	●●																						★												
TNMG160408-MP	0.8	●●	●●	●●	●●	●●																						●												
TNMG160412-MP	1.2	●★	●●	●●	●●	●●																						★												
TNMG220408-MP	0.8	★●	●●	●●	●●	●●																																		
TNMG220412-MP	1.2	★★	●●	●●	●●	●●																																		
<b>MM</b> 	TNMG160408-MM	0.8							●●●																															
	TNMG160412-MM	1.2							★★★																															
	TNMG220408-MM	0.8							★●★																															
	TNMG220412-MM	1.2							★★★																															
<b>MK</b> 	TNMG160404-MK	0.4													●●																									
	TNMG160408-MK	0.8													●●																									
	TNMG160412-MK	1.2													●●																									
	TNMG220408-MK	0.8													★●																									
	TNMG220412-MK	1.2													★★																									
* <b>MS</b> 	TNMG160404-MS	0.4																●●●	●●																					
	TNMG160408-MS	0.8																●●●	●●																					
	TNMG160412-MS	1.2																●●●	●●																					
	TNMG220408-MS	0.8																●●●	●●																					
<b>MS</b> 	TNMG160404-MS	0.4	●						●★									●●●	●●																					
	TNMG160408-MS	0.8	★						●★									●●●	●●	★						★														
	TNMG160412-MS	1.2	★						●●									★●	●●																					
	TNMG220408-MS	0.8	★						●★									★●●	★																					
	TNMG220412-MS	1.2							●																															
<b>GK</b> 	TNMG160404-GK	0.4													●●																									
	TNMG160408-GK	0.8													●●																									
	TNMG160412-GK	1.2													●●	★																								
	TNMG220408-GK	0.8													★●																									
	TNMG220412-GK	1.2													★★																									

\*Neu konzipierte Spanbrecher : MP9005, MP9015, MP9025, MT9015

● = NEW

A  
WSP DREHEN

NEG  
MIT LOCH

C

D

R

S

T

V

W

# WSP DREHEN [NEGATIV]



**TN** AUSFÜHRUNG  
WSP MIT LOCH

**TNMG 16 04 04- GM**

Größe Dicke Eckenradius Spanbrecher  
\* Siehe Seite A002.

## ÜBERSICHT DER SPANBRECHER FÜR DIV. MATERIALGRUPPEN

Schlichtzerspanung..... Leichtzerspanung..... Mittlere Zerspanung..... Schruppzerspanung..... Schwerzerspanung.....

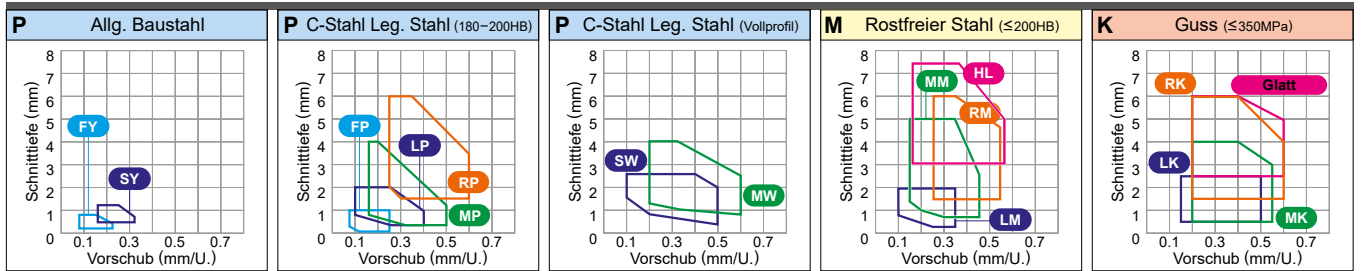

WSP DREHEN

A

Schnittbedingungen : ● : Stabile Bearbeitung ● : Allgemeine Bearbeitung ✱ : Instabile Bearbeitung

Material	Form	Bestellbezeichnung	RE (mm)	Beschichtet															Cermet	Besch. Cermet	Hartmetall	Zugehöriger Halter Seite																	
				UE6105	UE6110	UE6020	NEW MC6115	MC6015	MC6025	MC6035	UH6400	MS6015	MC7015	MC7025	MP7035	US735	US905	MC5005	MC5015	NEW MH515	MP9005		NEW MP9025	VP05RT	VP10RT	VP15TF	UP20M	NX2525	NX3035	MP3025	AP25N	VP25N	UT120T	HT110	RT9010	MT9015			
GM		TNMG160404-GM	0.4							●●●																													
		TNMG160408-GM	0.8								●●●																												
		TNMG160412-GM	1.2								●●●																												
		TNMG220408-GM	0.8								●●●																												
		TNMG220412-GM	1.2								●●●																												
MA		TNMG160404-MA	0.4	●●	●●	●●	●●	●●	●●	●●●	●●	●●	●●																										
		TNMG160408-MA	0.8	●●	●●	●●	●●	●●	●●	●●	●●●	●●	●●	●●																									
		TNMG160412-MA	1.2	●●	●●	●●	●●	●●	●●	●●	●●●	●●	●●	●●																									
		TNMG220408-MA	0.8	●●	●●	●●	●●	●●	●●	●●	●●●	●●	●●	●●																									
		TNMG220416-MA	1.6	●●	●●	●●	●●	●●	●●	●●	●●●	●●	●●	●●																									
		TNMG270608-MA	0.8	●●	●●	●●	●●	●●	●●	●●	●●●	●●	●●	●●																									
		TNMG270612-MA	1.2	●●	●●	●●	●●	●●	●●	●●	●●●	●●	●●	●●																									
		TNMG270616-MA	1.6	●●	●●	●●	●●	●●	●●	●●	●●●	●●	●●	●●																									
MH		TNMG160404-MH	0.4	●●	●●	●●	●●	●●	●●	●●●	●●	●●	●●																										
		TNMG160408-MH	0.8	●●	●●	●●	●●	●●	●●	●●	●●●	●●	●●	●●																									
		TNMG160412-MH	1.2	●●	●●	●●	●●	●●	●●	●●	●●●	●●	●●	●●																									
		TNMG220408-MH	0.8	●●	●●	●●	●●	●●	●●	●●	●●●	●●	●●	●●																									
		TNMG220412-MH	1.2	●●	●●	●●	●●	●●	●●	●●	●●●	●●	●●	●●																									
Standard		TNMG110304	0.4	●	●	●	●	●	●	●●																													
		TNMG110308	0.8	●	●	●	●	●	●	●	●●																												
		TNMG160304	0.4	●	●	●	●	●	●	●	●●																												
		TNMG160308	0.8	●	●	●	●	●	●	●	●●																												
		TNMG160404	0.4	●	●	●	●	●	●	●	●●																												
		TNMG160408	0.8	●	●	●	●	●	●	●	●●																												
		TNMG160412	1.2	●	●	●	●	●	●	●	●●																												
		TNMG160416	1.6	●	●	●	●	●	●	●	●●																												
		TNMG220404	0.4	●	●	●	●	●	●	●	●●																												
		TNMG220408	0.8	●	●	●	●	●	●	●	●●																												
		TNMG220412	1.2	●	●	●	●	●	●	●	●●																												
		TNMG220416	1.6	●	●	●	●	●	●	●	●●																												
		TNMG270608	0.8	●	●	●	●	●	●	●	●●																												
		TNMG270612	1.2	●	●	●	●	●	●	●	●●																												
		TNMG270616	1.6	●	●	●	●	●	●	●	●●																												
TNMG330924	2.4	●	●	●	●	●	●	●	●●																														

● : Lagerstandard. ★ : Lagerstandard in Japan.  
□ : Herstellung nur auf Anfrage.

● = NEW



















# WSP DREHEN [NEGATIV]



# WN AUSFÜHRUNG WSP MIT LOCH

**WNMG 08 04 02- FP**

 Größe Dicke Eckenradius Spanbrecher  
 \* Siehe Seite A002.

## ÜBERSICHT DER SPANBRECHER FÜR DIV. MATERIALGRUPPEN

Schlichtzerspanung..... Leichtzerspanung..... Mittlere Zerspanung..... Schruppzerspanung..... Schwerzerspanung.....

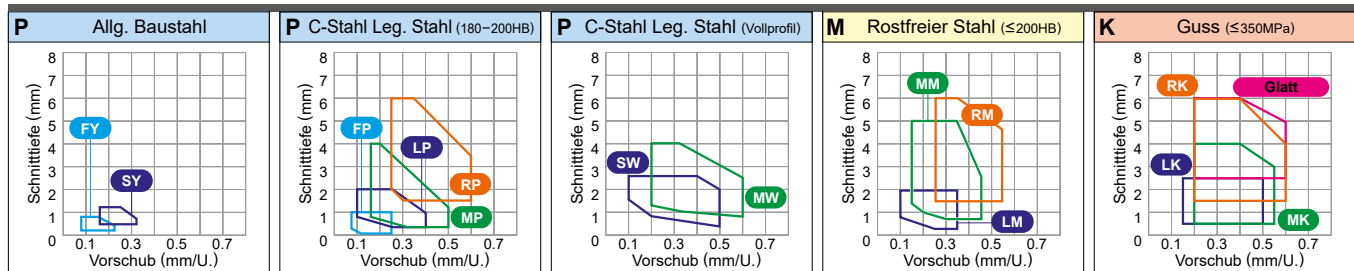
**A**  
WSP DREHEN

**NEG**  
MIT  
LOCH

**C**
**D**
**R**
**S**
**T**
**V**
**W**

Schnittbedingungen : ●: Stabile Bearbeitung ●: Allgemeine Bearbeitung ✦: Instabile Bearbeitung

Material	P Stahl		M Rostfreier Stahl		K Guss		N Nicht-Eisen-Metalle		S Hitzebeständige Legierungen, Titanlegierungen																															
	●	✦	●	✦	●	✦	●	✦	●	✦																														
Form	Bestellbezeichnung	RE (mm)	Beschichtet										Cermet	Besch. Cermet	Hartmetall	Zugehöriger Halter Seite																								
			UE6105	UE6110	UE6020	NEW MC6115	MC6015	MC6025	MC6035	UH6400	MS6015	MC7015					MC7025	MP7035	US735	US905	MC5005	MC5015	NEW MH515	NEW MP9005	NEW MP9015	NEW MP9025	VP05RT	VP10RT	VP15TF	UP20M	NX2525	NX3035	MP3025	AP25N	VP25N	UT120T	HT110	RT9010	MT9015	
<b>FP</b> 	WNMG080402-FP	0.2																																						
	WNMG080404-FP	0.4				●	●																			●	●												C022 C023 E017	
	WNMG080408-FP	0.8				●	●																				●	●												
	WNMG080412-FP	1.2				●	●																				●	●												
<b>FH</b> 	WNMG080404-FH	0.4	★																							●	★											C022 C023 E017		
	WNMG080408-FH	0.8	★																								★	★												
<b>FS</b> 	WNMG080404-FS	0.4																									★												C022 C023 E017	
	WNMG080408-FS	0.8																								●														
<b>FY</b> 	WNMG080404-FY	0.4																								★	★												C022 C023 E017	
	WNMG080408-FY	0.8	★																							★	★	★												
<b>LP</b> 	WNMG060404-LP	0.4	★	★			●	●	●																			●												C022 C023 E017 E039
	WNMG060408-LP	0.8	●	★			●	●	●																				★											
	WNMG06T304-LP	0.4	★	★			●	●	●																				★											
	WNMG06T308-LP	0.8	★	★			●	●	●																				●											
	WNMG080404-LP	0.4	●	●			●	●	●	●																			★											
	WNMG080408-LP	0.8	★	●			●	●	●	●																			●											
<b>LM</b> 	WNMG060404-LM	0.4																																						
	WNMG060408-LM	0.8								●	●	●																												
	WNMG080404-LM	0.4								●	●	●																												
	WNMG080408-LM	0.8								●	●	●																												

● = NEW

● : Lagerstandard. ★ : Lagerstandard in Japan.









# WSP DREHEN [NEGATIV]

## 80° WN AUSFÜHRUNG WSP MIT LOCH

**WNMG 08 04 08- RK**

Größe Dicke Eckenradius Spanbrecher  
\* Siehe Seite A002.

### ÜBERSICHT DER SPANBRECHER FÜR DIV. MATERIALGRUPPEN

Schlichtzerspannung... Leichtzerspannung... Mittlere Zerspannung... Schruppszerspannung... Schwerzerspannung...

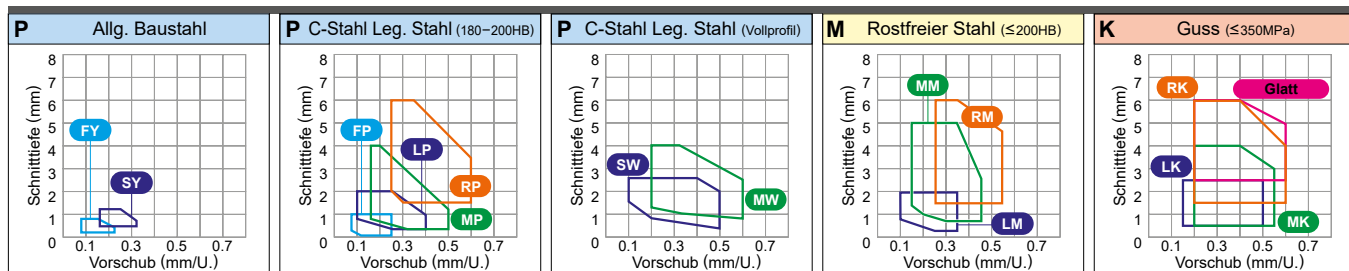

Schnittbedingungen : ● : Stabile Bearbeitung ● : Allgemeine Bearbeitung ✦ : Instabile Bearbeitung

Material	Form	Bestellbezeichnung	RE (mm)	Beschichtet																	Cermet	Besch. Cermet	Hartmetall	Zugehöriger Halter Seite																								
P Stahl	RK  Schruppszerspannung RS  Schruppszerspannung GH  Schruppszerspannung GJ  Schruppszerspannung Glatt 	WNNMG080408-RK	0.8	UE6105	UE6110	UE6020	NEW MC6115	NEW MC6125	MC6015	MC6025	MC6035	UH6400	MS6015	MC7015	MC7025	MP7035	US735	US905	MC5005	MC5015	NEW MH515	MP9005	NEW MP9015	NEW MP9025	VP05RT	VP10RT	VP15TF	UP20M	NX2525	NP3035	MP3025	AP25N	VP25N	UT120T	HT110	RT9010	MT9015											
M Rostfreier Stahl		WNNMG080412-RK	1.2																																													
K Guss		WNNMG080416-RK	1.6																																													
N Nicht-Eisen-Metalle																																																
S Hitzebeständige Legierungen, Titanlegierungen																																																

● = NEW

● : Lagerstandard. ★ : Lagerstandard in Japan.

□ : Herstellung nur auf Anfrage.







### ÜBERSICHT DER SPANBRECHER FÜR DIV. MATERIALGRUPPEN

Schwerzerspannung.....

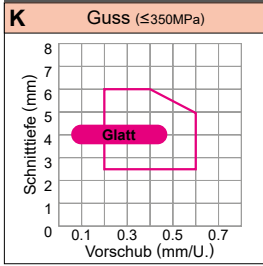

Schnittbedingungen : ● : Stabile Bearbeitung ● : Allgemeine Bearbeitung ✦ : Instabile Bearbeitung

Material	P	Stahl																																				
	M	Rostfreier Stahl																																				
Form	K	Guss																																				
	N	Nicht-Eisen-Metalle																																				
	S	Hitzebeständige Legierungen, Titanlegierungen																																				
Form	Bestellbezeichnung	RE (mm)	Beschichtet															Cermet	Besch. Cermet	Hartmetall		Zugehöriger Halter Seite																
			UE6105	UE6110	UE6020	MC6115 NEW	MC6015	MC6025	MC6035	UH6400	MS6015	MC7015	MC7025	MP7035	US735	US905	MC5005	MC5015	MH515 NEW	MP9005	MP9015	MP9025 NEW	VP05RT	VP10RT	VP15TF	UP20M	NX2525	NX3035	MP3025	AP25N	VP25N	UTi20T	HTi10	RT9010	MT9015			
Glatt	SNMN090308	0.8																																				
	SNMN120408	0.8															★ ●											★								●	★	
	SNMN120412	1.2															★ ●											★								●		
	SNMN120416	1.6															★ ★											★										
	SNMN190412	1.2																																		●		
Glatt	SNGN090308	0.8																																			★	
	SNGN120404	0.4																																		★	★	
	SNGN120408	0.8																																		★		

● = NEW

**A**

WSP DREHEN

**NEG**

OHNE LOCH

C

D

R

S

T

V

W





# WSP DREHEN [POSITIV]



**CCMT 06 02 02- FP**

Größe Dicke Eckenradius Spanbrecher  
\* Siehe Seite A002.

## ÜBERSICHT DER SPANBRECHER FÜR DIV. MATERIALGRUPPEN

Schlichtzerspannung.....

Leichtzerspannung.....

Mittlere Zerspanung.....

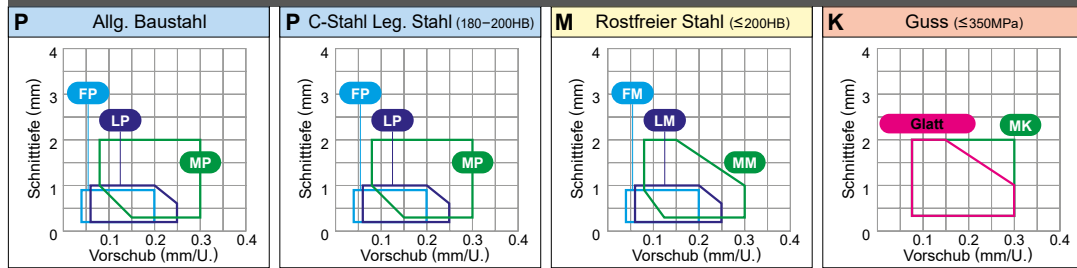

Schnittbedingungen : ● : Stabile Bearbeitung ● : Allgemeine Bearbeitung ✦ : Instabile Bearbeitung

Material	Form	Bestellbezeichnung	RE (mm)	Beschichtet												Cermet	Besch. Cermet	Hartmetall	Zugehöriger Halter Seite																			
				UE6105	UE6110	MC6015	MC6025	UH6400	MS6015	MC7025	MP7035	US735	US905	MC5005	MC5015					MH515 NEW	MP9005	MP9015	MP9025 NEW	MS9025	VP05RT	VP10RT	VP15TF	UP20M	NX2525	NX3035	MP3025	AP25N	VP25N	VP45N	UTI20T	HT110	RT9010	MT9005
Schlichtzerspannung	FP	CCMT060202-FP	0.2	●●●																																	C024	
		CCMT060204-FP	0.4	●●●																																	D010	
		CCMT09T302-FP	0.2	★●●																																	E007	
		CCMT09T304-FP	0.4	●●●																																	E008	
		CCMT09T308-FP	0.8	★●●																																	E032	
Schlichtzerspannung	FM	CCMT060202-FM	0.2																																	C024		
		CCMT060204-FM	0.4																																	D010		
		CCMT09T302-FM	0.2																																		E007	
		CCMT09T304-FM	0.4																																		E008	
		CCMT09T308-FM	0.8																																		E032	
Schlichtzerspannung	FS	CCGT060201M-FS	0.08												●●																					C024		
		CCGT060202M-FS	0.18												●●																					D010		
		CCGT09T301M-FS	0.08												●●																						E007	
		CCGT09T302M-FS	0.18												●●																						E008	
		CCGT09T304M-FS	0.38												●●																						E032	
Schlichtzerspannung	FS-P	CCGT060201M-FS-P	0.08												●																					C024		
		CCGT060202M-FS-P	0.18												●●																					D010		
		CCGT09T301M-FS-P	0.08												●●																						E007	
		CCGT09T302M-FS-P	0.18												●●																							E008
		CCGT09T304M-FS-P	0.38												●●																							E032
Schlichtzerspannung	FV	CCMT060202-FV	0.2																																		C024	
		CCMT060204-FV	0.4																																		D010	
		CCMT09T302-FV	0.2																							●★											E007	
		CCMT09T304-FV	0.4																							●●											E008	
		CCMT09T308-FV	0.8																							●★											E032	
Schlichtzerspannung	FJ	CCGT0602V5-FJ	0.05																																		C024	
		CCGT060201-FJ	0.1																																		D010	
		CCGT060202-FJ	0.2																																			E007
		CCGT09T3V5-FJ	0.05																																			E008
		CCGT09T301-FJ	0.1																																			E032
		CCGT09T302-FJ	0.2																																			E036

● = NEW

SPANBRECHER > A058  
SORTEN > A030  
IDENTIFIKATION > A002

WSP DREHEN

POSI 7°

MIT LOCH

C

D

R

S

T

V

W

# WSP DREHEN [POSITIV]



**CCGT 06 02 02- AZ**

Größe Dicke Eckenradius Spanbrecher  
\* Siehe Seite A002.

## ÜBERSICHT DER SPANBRECHER FÜR DIV. MATERIALGRUPPEN

Schlichtzerspanung.....

Leichtzerspanung.....

Mittlere Zerspanung.....

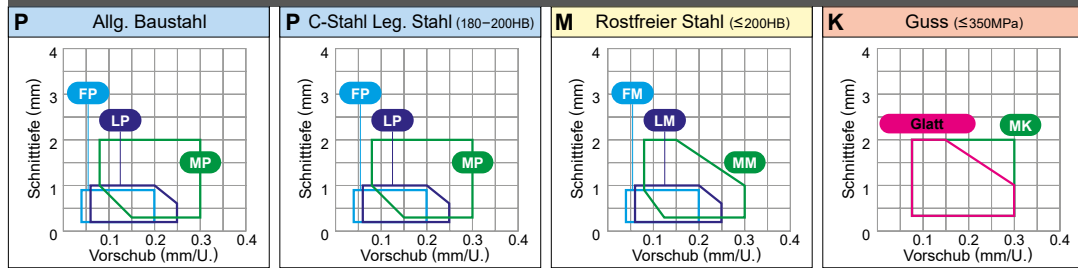

WSP DREHEN

A









Schnittbedingungen : ● : Stabile Bearbeitung ● : Allgemeine Bearbeitung ✦ : Instabile Bearbeitung

Material	Form	Bestellbezeichnung	RE (mm)	Beschichtet												Cermet	Besch. Cermet	Hartmetall	Zugehöriger Halter Seite																		
				UE6105	UE6110	MC6015	MC6025	UH6400	MS6015	MC7025	MP7035	US735	US905	MC5005	MC5015					MH515	MP9005	MP9015	MP9025	MS9025	VP05RT	VP10RT	VP15TF	UP20M	NX2525	NX3035	MP3025	AP25N	VP25N	VP45N	UTi20T	HTi10	RT9010
P Stahl	AZ	CCGT060202-AZ	0.2	●●●●●																																	
		CCGT060204-AZ	0.4																																		
		CCGT09T302-AZ	0.2																																C024		
		CCGT09T304-AZ	0.4																																D010		
		CCGT09T308-AZ	0.8																																E007		
M Rostfreier Stahl	R/L-F	CCGT120402-AZ	0.2																															E008			
		CCGT120404-AZ	0.4																																E032		
		CCGT120408-AZ	0.8																																E036		
		CCGT03S1V3L-F	0.03																																		
		CCGT03S101L-F	0.1																																		
		CCGT03S102L-F	0.2																																		
		CCGT03S104L-F	0.4																																		
		CCGT04T0V3L-F	0.03																																		
		CCGT04T001L-F	0.1																																		
		CCGT04T002L-F	0.2																																		
K Guss	R/L-F	CCGT04T004L-F	0.4																																		
		NEW CCGT03S101MR-F	0.08					●																													
		NEW CCGT03S101ML-F	0.08					●																													
		NEW CCGT03S102MR-F	0.18					●																													
		NEW CCGT03S102ML-F	0.18					●																													
		NEW CCGT03S104MR-F	0.38					●																													
		NEW CCGT03S104ML-F	0.38					●																													
		NEW CCGT04T001MR-F	0.08					●																													
		NEW CCGT04T001ML-F	0.08					●																													
		NEW CCGT04T002MR-F	0.18					●																													
S Hitzbeständige Legierungen, Titanlegierungen	Schlichtzerspanung	NEW CCGT04T002ML-F	0.18					●																													
		NEW CCGT04T004MR-F	0.38					●																													
		NEW CCGT04T004ML-F	0.38					●																													
		CCGH060202R-F	0.2													●	★	★	★	★															C024		
		CCGH060202L-F	0.2													●	●	★	★	★															D010		
N Nicht-Eisen-Metalle	Schlichtzerspanung	CCGH060204R-F	0.4												●	★	★	★	★																E007		
		CCGH060204L-F	0.4													●	●	★	★	★															E008		
		CCGH060204L-F	0.4													●	●	★	★	★															E032		

● = NEW

● : Lagerstandard. ★ : Lagerstandard in Japan.

Schnittbedingungen : ● : Stabile Bearbeitung ● : Allgemeine Bearbeitung ✱ : Instabile Bearbeitung

Material	P	Stahl	●	●	●	✱	✱	✱	✱	✱	✱	✱	✱	✱	✱	✱	✱	✱	✱	✱	✱	✱													
	M	Rostfreier Stahl	●	●	●	✱	✱	✱	✱	✱	✱	✱	✱	✱	✱	✱	✱	✱	✱	✱	✱	✱													
Form	Bestellbezeichnung	RE (mm)	Beschichtet															Cermet	Besch. Cermet	Hartmetall			Zugehöriger Halter Seite												
			UE6105	UE6110	MC6015	MC6025	UH6400	MS6015	MC7025	MP7035	US735	US905	MC5005	MC5015	MH515	MP9005	MP9015	MP9025	MS9025	VP05RT	VP10RT	VP15TF		UP20M	NX2525	NX3035	MP3025	AP25N	VP25N	VP45N	UT120T	HT110	RT9010	MT9005	MT9015
			NEW	NEW	NEW	NEW	NEW	NEW	NEW	NEW	NEW	NEW	NEW	NEW	NEW	NEW	NEW	NEW	NEW	NEW	NEW	NEW		NEW	NEW	NEW	NEW	NEW	NEW	NEW	NEW	NEW	NEW	NEW	NEW
 Schlitzzerspanung	NEW CCGH060202MR-F	0.18						●																											
	NEW CCGH060202ML-F	0.18						●																											
	NEW CCGH060204MR-F	0.38						●																											
	NEW CCGH060204ML-F	0.38						●																											
 Leichtzerspanung	CCMT060204-LP	0.4	●	●	●													●		●															
	CCMT060208-LP	0.8	★	●	●														●		★														
	CCMT09T304-LP	0.4	●	●	●														●		●														
	CCMT09T308-LP	0.8	●	●	●														●		★														
 Leichtzerspanung	CCMT060204-LM	0.4					●	●																											
	CCMT060208-LM	0.8					●	★																											
	CCMT09T304-LM	0.4					●	●																											
	CCMT09T308-LM	0.8					●	●																											
 Leichtzerspanung	CCMT060202-LS	0.2																																	
	CCMT060204-LS	0.4																																	
	CCMT09T302-LS	0.2																																	
	CCMT09T304-LS	0.4																																	
	CCMT09T308-LS	0.8																																	
 Leichtzerspanung	CCGT060201M-LS	0.08																																	
	CCGT060202M-LS	0.18																																	
	CCGT09T301M-LS	0.08																																	
	CCGT09T302M-LS	0.18																																	
	CCGT09T304M-LS	0.38																																	
 Leichtzerspanung	CCGT060201M-LS-P	0.08						●																											
	CCGT060202M-LS-P	0.18						●																											
	CCGT09T301M-LS-P	0.08						●																											
	CCGT09T302M-LS-P	0.18						●																											
	CCGT09T304M-LS-P	0.38						●																											
 Leichtzerspanung	CCMH060202-SV	0.2			●				●										●	★	★							★							
	CCMH060204-SV	0.4			●				●											●	★	★	●						★						
 Leichtzerspanung (Vollprofil)	CCMT060202-SW	0.2	●	●	●														●		●	★													
	CCMT060204-SW	0.4	●	●	●															●		●	★												
	CCMT09T302-SW	0.2	●	●	●															●		●	★												
	CCMT09T304-SW	0.4	●	●	●															●		●	★												

\* Vor dem Einsatz des SW-Spanbrechers (Vollprofil), beachten Sie bitte Seite A028.

● = NEW

**A**

WSP DREHEN

**POSI**  
7°

MIT LOCH

**C**

D

R

S

T

V

W

SPANBRECHER > A058  
 SORTEN > A030  
 IDENTIFIKATION > A002

# WSP DREHEN [POSITIV]



**CCGT 06 02 V3 R-SS**  
 Größe D Dicke Eckenradius R/L Spanbrecher  
 \* Siehe Seite A002.

## ÜBERSICHT DER SPANBRECHER FÜR DIV. MATERIALGRUPPEN

Schichtzerspanung..... Leichtzerspanung..... Mittlere Zerspanung.....

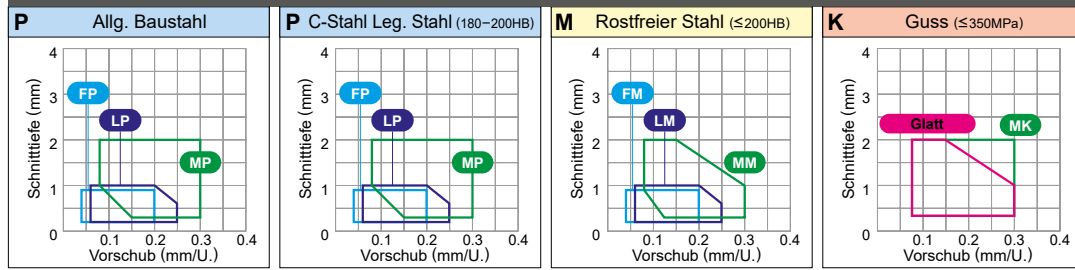

WSP DREHEN

A







Schnittbedingungen : ● : Stabile Bearbeitung ● : Allgemeine Bearbeitung ✦ : Instabile Bearbeitung

Material	Form	Bestellbezeichnung	RE (mm)	Beschichtet												Cermet	Besch. Cermet		Hartmetall			Zugehöriger Halter Seite																	
				UE6105	UE6110	MC6015	MC6025	UH6400	MS6015	MC7025	MP7035	US735	US905	MC5005	MC5015		MH515	MP9005	MP9015	NEW MP9025	NEW MS9025		VP05RT	VP10RT	VP15TF	UP20M	NX2525	NX3035	MP3025	AP25N	VP25N	VP45N	UTI20T	HT110	RT9010	MT9005	MT9015		
Stahl	R/L-SS	CCGT0602V3R-SS	0.03																		*																		
		CCGT0602V3L-SS	0.03																			*																	
		CCGT060201R-SS	0.1																			*																	
		CCGT060201L-SS	0.1																			*																	
		CCGT060202R-SS	0.2																			*																C024	
Rostfreier Stahl	Leichtzerspanung	CCGT09T3V3R-SS	0.03																		*																E007		
		CCGT09T3V3L-SS	0.03																		*																E008		
		CCGT09T301R-SS	0.1																		*																	E032	
		CCGT09T301L-SS	0.1																		*																E036		
		CCGT09T302R-SS	0.2																		*																		
		CCGT09T302L-SS	0.2																		*																		
		CCGT060201MR-SS	0.08								●																												
		NEW CCGT060201ML-SS	0.08								●																												
		CCGT060202MR-SS	0.18								●																												
		NEW CCGT060202ML-SS	0.18								●																												
		CCGT09T301MR-SS	0.08								●																												
		NEW CCGT09T301ML-SS	0.08								●																												
		CCGT09T302MR-SS	0.18								●																												
		NEW CCGT09T302ML-SS	0.18								●																												
		CCGT09T304MR-SS	0.38								●																												
NEW CCGT09T304ML-SS	0.38								●																														
Guss	Mittlere Zerspanung	CCMT060204-MP	0.4	●	●	●																		●	●												C024		
		CCMT060208-MP	0.8	●	●	●																		●	●	*	*										D010		
		CCMT09T304-MP	0.4	●	●	●																			●	●											E007		
		CCMT09T308-MP	0.8	●	●	●																				●	●	*	*									E008	
		CCMT120404-MP	0.4	●	●	●																				●	●	*	*									E032	
		CCMT120408-MP	0.8	●	●	●																				●	●	*	*									E036	
Leichtzerspanung	Mittlere Zerspanung	CCMT120412-MP	1.2	★	●	●																		●	●	*	*												
		CCMT060204-MM	0.4									●	●																									C024	
		CCMT060208-MM	0.8									●	●																									D010	
		CCMT09T304-MM	0.4									●	●																									E007	
		CCMT09T308-MM	0.8									●	●																									E008	
		CCMT120404-MM	0.4									●	●																									E032	
		CCMT120408-MM	0.8									●	●																									E036	
CCMT120412-MM	1.2									●	★													●	●														

● = NEW

● : Lagerstandard. ★ : Lagerstandard in Japan.

Schnittbedingungen : ● : Stabile Bearbeitung ● : Allgemeine Bearbeitung ✦ : Instabile Bearbeitung

Material	P	Stahl	●	●	●	✦	✦	✦																																
	M	Rostfreier Stahl																																						
Material	K	Guss																																						
	N	Nicht-Eisen-Metalle																																						
	S	Hitzbeständige Legierungen, Titanlegierungen																																						
Form	Bestellbezeichnung	RE (mm)	Beschichtet																Cermet	Besch. Cermet	Hartmetall			Zugehöriger Halter Seite																
			UE6105	UE6110	MC6015	MC6025	UH6400	MS6015	MC7025	MP7035	US735	US905	MC5005	MC5015	MH515	MP9005	MP9015	MP9025			MS9025	VP05RT	VP10RT		VP15TF	UP20M	NX2525	NX3035	MP3025	AP25N	VP25N	VP45N	UTi20T	HTi10	RT9010	MT9005	MT9015			
<b>MK</b> 	CCMT060204-MK	0.4											●	●																										
	CCMT060208-MK	0.8											●	●																										
	CCMT09T304-MK	0.4											●	●																										
	CCMT09T308-MK	0.8											●	●																										
	CCMT120404-MK	0.4											●	●																										
	CCMT120408-MK	0.8											●	●																										
	Mittlere Zerspanung CCMT120412-MK	1.2											★	●																										
<b>MS</b> 	CCMT060202-MS	0.2												●	●	●																						●		
	CCMT060204-MS	0.4													●	●	●																					●		
	CCMT060208-MS	0.8													●	●	●																					●		
	CCMT09T302-MS	0.2													●	●	●																					●		
	CCMT09T304-MS	0.4													●	●	●																					●		
	CCMT09T308-MS	0.8													●	●	●																					●		
	CCMT120404-MS	0.4													●	●	●																					●		
	Mittlere Zerspanung CCMT120408-MS	0.8													●	●	●																					●		
CCMT120412-MS	1.2													●	●	●																					●			
<b>Standard</b> 	CCMT060202	0.2								●													●	●	●	★		●												
	CCMT060204	0.4	●	●							●									●	●	●	●	●	★		●													
	CCMT060208	0.8	●	●							●									●	★						●													
	CCMT080302	0.2	★																																					
	CCMT080304	0.4	●	●							●												●	★	●	★		●												
	CCMT080308	0.8	●	●							●																	●												
	CCMT09T302	0.2	●	●							●												●	●	●	★		●												
	CCMT09T304	0.4	●	●							●												●	●	●	★		●												
	CCMT09T308	0.8	●	●							●												●	●	●	★		●												
	CCMT120404	0.4	★	●								●											●	●	●	★		●												
Mittlere Zerspanung CCMT120408	0.8	★	●								●											●	●	●			●													
CCMT120412	1.2	●	●								●												★																	
<b>MV</b> 	CCMH060202-MV	0.2			●					●												●	★	●	★	★		●												
	CCMH060204-MV	0.4			●					●		●											●	●	●	★	●		●											
Mittlere Zerspanung																																								
<b>* MW</b> 	CCMT060204-MW	0.4			●	●																	●	●	★															
	CCMT060208-MW	0.8			●	●																		●	●	★														
	CCMT09T304-MW	0.4			●	●																		●	●	★														
	CCMT09T308-MW	0.8			●	●																		●	●	★														
	Mittlere Zerspanung (Vollprofil) CCMT120404-MW	0.4			●	●																		●	●	★														
CCMT120408-MW	0.8			●	●																		●	●	★															
<b>R/L-SR</b> 	CCET0602V3R-SR	0.03																			★	★													★					
	CCET0602V3L-SR	0.03																				●	★													★				
	CCET060201R-SR	0.1																				★	★													★				
	CCET060201L-SR	0.1																				★	★													★				
	CCET060202R-SR	0.2																				★	★													★				
	Mittlere Zerspanung CCET060202L-SR	0.2																				●	●													★				

\* Vor dem Einsatz des MW-Spanbrechers (Vollprofil), beachten Sie bitte Seite A028.

● = NEW

SPANBRECHER > A058  
SORTEN > A030  
IDENTIFIKATION > A002

A  
WSP DREHEN

POSI 7°  
MIT LOCH

C

D

R

S

T

V





W







Schnittbedingungen : ● : Stabile Bearbeitung ● : Allgemeine Bearbeitung ✖ : Instabile Bearbeitung

Material	P	Stahl	UE6105	UE6110	MC6015	MC6025	UH6400	MS6015	MC7025	MP7035	US735	US905	MC5005	MC5015	MH515	MP9005	MP9015	MP9025	MS9025	VP05RT	VP10RT	VP15TF	UP20M	NX2525	NX3035	MP3025	AP25N	VP25N	VP45N	UTi20T	HTi10	RT9010	MT9005	MT9015	Zugehöriger Halter Seite				
	M	Rostfreier Stahl	K	Guss	N	Nicht-Eisen-Metalle	S	Hitzbeständige Legierungen, Titanlegierungen	Beschichtet	Cermet	Besch. Cermet	Hartmetall																											
Form	Bestellbezeichnung	RE (mm)																																					
 Mittlere Zerspanung	R/L-SN	CCET060200R-SN	0																																		C024 D010 E007 E008 E032 E036		
		CCET060200L-SN	0																																				
		CCET0602V3R-SN	0.03																																				
		CCET0602V3L-SN	0.03																																				
		CCET060201R-SN	0.1																																				
		CCET060201L-SN	0.1																																				
		CCET060202R-SN	0.2																																				
		CCET060202L-SN	0.2																																				
		CCET060204R-SN	0.4																																				
		CCET060204L-SN	0.4																																				
		CCET09T300R-SN	0																																				
		CCET09T300L-SN	0																																				
		CCET09T3V3R-SN	0.03																																				
		CCET09T3V3L-SN	0.03																																				
		CCET09T301R-SN	0.1																																				
		CCET09T301L-SN	0.1																																				
		CCET09T302R-SN	0.2																																				
		CCET09T302L-SN	0.2																																				
	CCET09T304R-SN	0.4																																					
	CCET09T304L-SN	0.4																																					
 Mittlere Zerspanung (Vollprofil)	R/LW-SN *	CCET0602V3RW-SN	0.03																																	C024 D010 E007 E008 E032 E036			
		CCET0602V3LW-SN	0.03																																				
		CCET09T3V3RW-SN	0.03																																				
		CCET09T3V3LW-SN	0.03																																				
 Mittlere Zerspanung	SMG	CCGT060201M-SMG	0.08					●																												C024 D010 E007 E008 E032 E036			
		CCGT060202M-SMG	0.18					●																															
		CCGT060204M-SMG	0.38					●																															
		CCGT09T301M-SMG	0.08					●																															
		CCGT09T302M-SMG	0.18					●																															
	CCGT09T304M-SMG	0.38					●																																
 Glatt	Glatt	CCMW060202	0.2																																	C024 D010 E007 E008 E032 E036			
		CCMW060204	0.4						●	●																													
		CCMW060208	0.8							★	★																												
		CCMW09T304	0.4						●	●															□														
		CCMW09T308	0.8						●	●																													
		CCMW09T312	1.2							★	★																												
		CCMW120404	0.4						●	●															□														
		CCMW120408	0.8						●	●																													
	CCMW120412	1.2							★	●																													
 Glatt	Glatt	CCGW060200	0																							★										C024 D010 E007 E008 E032 E036			
		CCGW0602V5	0.05																								●												
		CCGW09T300	0																									●											
		CCGW09T3V5	0.05																										●										

\* Vor dem Einsatz des R/LW-SN-Spanbrechers (Vollprofil), beachten Sie bitte Seite A028.

● = NEW

A  
WSP DREHEN

POSI  
7°  
MIT  
LOCH  
C

D  
R  
S  
T  
V  
W

# WSP DREHEN [POSITIV]



**CPMH 08 02 02- FV**

Größe Dicke Eckenradius Spanbrecher  
\* Siehe Seite A002.

## ÜBERSICHT DER SPANBRECHER FÜR DIV. MATERIALGRUPPEN

Schlichtzerspanung..... Leichtzerspanung..... Mittlere Zerspanung.....

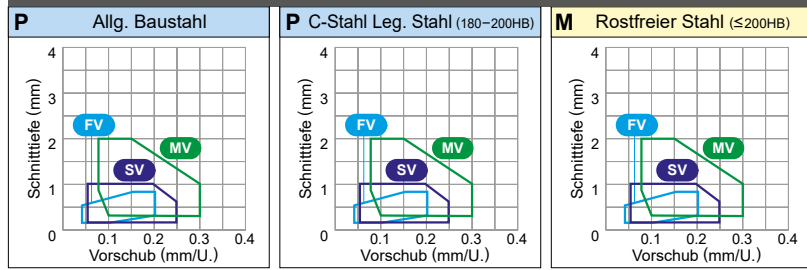

WSP DREHEN

A

Schnittbedingungen : ● : Stabile Bearbeitung ● : Allgemeine Bearbeitung ✦ : Instabile Bearbeitung

Material	Stahl		Rostfreier Stahl		Guss		Nicht-Eisen-Metalle		Hitzebeständige Legierungen, Titanlegierungen		Beschichtet										Cermet	Besch. Cermet	Hartmetall		Zugehöriger Halter Seite																						
	P	M	M	M	K	K	N	N	S	S	UE6105	UE6110	MC6015	MC6025	UH6400	MS6015	MC7025	MP7035	US735	US905	MC5005	MC5015	MH515	MP9005		MP9015	MP9025	MS9025	VP05RT	VP10RT	VP15TF	UP20M	NX2525	NX3035	MP3025	AP25N	VP25N	VP45N	UTI20T	HT110	RT9010	MT9005	MT9015				
<b>FV</b>  Schlichtzerspanung	CPMH080202-FV	0.2																																													
	CPMH080204-FV	0.4																																													
	CPMH090302-FV	0.2																																													
	CPMH090304-FV	0.4																																													
	CPMH090308-FV	0.8																																													
<b>Standard</b>  Schlichtzerspanung	CPGT080202	0.2																																													
	CPGT080204	0.4																																													
	CPGT090302	0.2																																													
	CPGT090304	0.4																																													
<b>R/L-F</b>  Schlichtzerspanung	CPMH080204R-F	0.4																																													
	CPMH080204L-F	0.4																																													
	CPMH090304R-F	0.4																																													
	CPMH090304L-F	0.4																																													
<b>R/L-F</b>  Schlichtzerspanung	CPGT080204R-F	0.4																																													
	CPGT080204L-F	0.4																																													
	CPGT090302R-F	0.2																																													
	CPGT090302L-F	0.2																																													
	CPGT090304R-F	0.4																																													
	CPGT090304L-F	0.4																																													
<b>SV</b>  Leichtzerspanung	CPMH080202-SV	0.2			●		●																																								
	CPMH080204-SV	0.4			●		●																																								
	CPMH090302-SV	0.2			●		●																																								
	CPMH090304-SV	0.4			●		●																																								
	CPMH090308-SV	0.8			●		●																																								
<b>Standard</b>  Mittlere Zerspanung	CPMX080204	0.4			★																																										
	CPMX080208	0.8			★																																										
	CPMX090304	0.4			★																																										
	CPMX090308	0.8			★																																										
<b>MV</b>  Mittlere Zerspanung	CPMH080204-MV	0.4			●		●		●																																						
	CPMH080208-MV	0.8			●		●		●																																						
	CPMH090304-MV	0.4			●		●		●																																						
	CPMH090308-MV	0.8			●		●		●																																						

● = NEW

● : Lagerstandard. ★ : Lagerstandard in Japan.

### ÜBERSICHT DER SPANBRECHER FÜR DIV. MATERIALGRUPPEN

Schlichtzerspanung.....

Leichtzerspanung.....

Mittlere Zerspanung.....

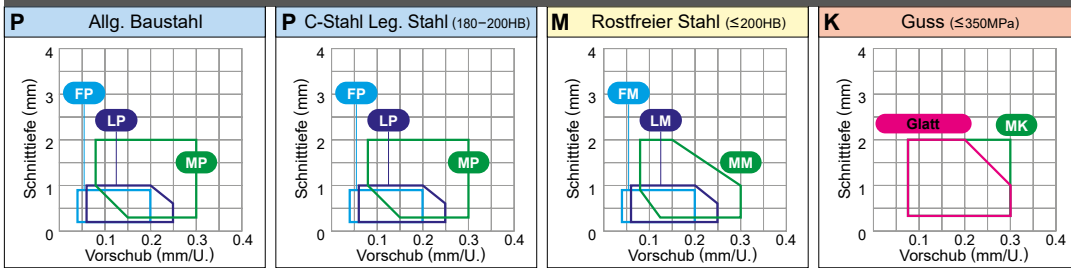

Schnittbedingungen : ● : Stabile Bearbeitung ● : Allgemeine Bearbeitung ✦ : Instabile Bearbeitung

Material	Form	Bestellbezeichnung	RE (mm)	Beschichtet														Cermet	Besch. Cermet	Hartmetall	Zugehöriger Halter Seite														
				UE6105	UE6110	MC6015	MC6025	UH6400	MS6015	MC7025	MP7035	US735	US905	MC5005	MC5015	MH515	MP9005					MP9015	MP9025	MS9025	VP05RT	VP10RT	VP15TF	UP20M	NX2525	NX3035	MP3025	AP25N	VP25N	VP45N	UTI20T
P Stahl	Schlichtzerspanung	DCMT070202-FP	0.2	●●●																														C025	
		DCMT070204-FP	0.4	●●●																														D011	
		DCMT11T302-FP	0.2	●●●																														E010	
		DCMT11T304-FP	0.4	●●●																														E011	
		DCMT11T308-FP	0.8	●●●																														E031	
M Rostfreier Stahl (≤200HB)	Schlichtzerspanung	DCMT070202-FM	0.2																															C025	
		DCMT070204-FM	0.4																															D011	
		DCMT11T302-FM	0.2																															E010	
		DCMT11T304-FM	0.4																															E011	
		DCMT11T308-FM	0.8																															E031	
K Guss (≤350MPa)	Schlichtzerspanung	DCGT070201M-FS	0.08																															C025	
		DCGT070202M-FS	0.18																															D011	
		DCGT11T301M-FS	0.08																															E010	
		DCGT11T302M-FS	0.18																															E011	
		DCGT11T304M-FS	0.08																															E031	
N Nicht-Eisen-Metalle	Schlichtzerspanung	DCGT11T302M-FS	0.18																															E033	
		DCGT070201M-FS-P	0.08																															C025	
		DCGT070202M-FS-P	0.18																															D011	
		DCGT070204M-FS-P	0.38																															D026	
		DCGT11T301M-FS-P	0.08																															E010	
S Hitzebeständige Legierungen, Titanlegierungen	Schlichtzerspanung	DCGT11T302M-FS-P	0.18																															E011	
		DCGT11T304M-FS-P	0.08																															E031	
		DCGT11T302M-FS-P	0.18																															E033	
		DCGT11T304M-FS-P	0.38																																E033
		DCGT11T304M-FS-P	0.38																																E033
K Guss (≤350MPa)	Schlichtzerspanung	DCMT070202-FV	0.2	●																														C025	
		DCMT070204-FV	0.4	●																														D011	
		DCMT070208-FV	0.8																																D026
		DCMT11T302-FV	0.2																																E010
		DCMT11T304-FV	0.4	●																															E011
K Guss (≤350MPa)	Schlichtzerspanung	DCMT11T308-FV	0.8	●																															E031
		DCMT11T308-FV	0.8	●																															E033
		DCGT070202-AZ	0.2																																C025
		DCGT070204-AZ	0.4																																D011
		DCGT11T302-AZ	0.2																																E010
K Guss (≤350MPa)	Mittlere Zerspanung	DCGT11T304-AZ	0.4																															E011	
		DCGT11T308-AZ	0.8																															E031	
		DCGT11T308-AZ	0.8																																E033

● = NEW

# WSP DREHEN [POSITIV]



**DCGT 07 02 02 R-F**

Größe Dicke Eckenradius R/L Spanbrecher  
\* Siehe Seite A002.

## ÜBERSICHT DER SPANBRECHER FÜR DIV. MATERIALGRUPPEN

Schlichtzerspanung..... Leichtzerspanung..... Mittlere Zerspanung.....

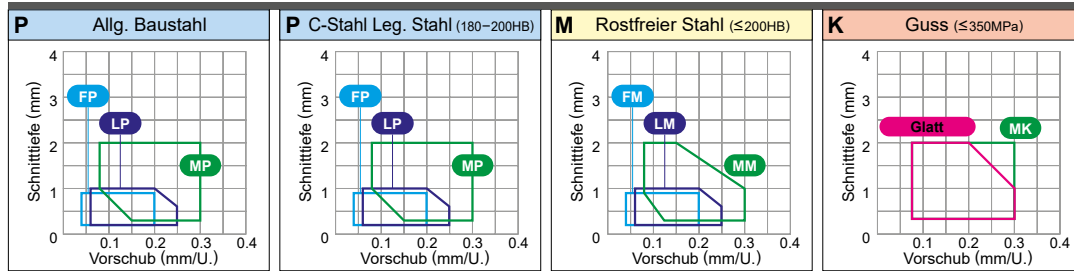

WSP DREHEN

A

Schnittbedingungen : ● : Stabile Bearbeitung ● : Allgemeine Bearbeitung ✦ : Instabile Bearbeitung

Material	Form	Bestellbezeichnung	RE (mm)	Beschichtet												Cermet	Besch. Cermet	Hartmetall	Zugehöriger Halter Seite																			
				UE6105	UE6110	MC6015	MC6025	UH6400	MS6015	MC7025	MP7035	US735	US905	MC5005	MC5015					MH515	MP9005	MP9015	MP9025	MS9025	VP05RT	VP10RT	VP15TF	UP20M	NX2525	NX3035	MP3025	AP25N	VP25N	VP45N	UTi20T	HT110	RT9010	MT9005
P Stahl	R/L-F	DCGT070202R-F	0.2	●●●●●●●●																																		
		DCGT070202L-F	0.2																																			
		DCGT070204R-F	0.4																																			
M Rostfreier Stahl	R/L-F	DCGT070204L-F	0.4																																			
		DCGT11T302R-F	0.2																																			
		DCGT11T302L-F	0.2																																			
K Guss	R/L-F	DCGT11T304R-F	0.4																																			
		DCGT11T304L-F	0.4																																			
		DCGT11T304F	0.4																																			
N Nicht-Eisen-Metalle	R-SRF	DCGT11T301MR-SRF	0.08																																			
		DCGT11T302MR-SRF	0.18																																			
		DCGT11T304MR-SRF	0.38																																			
S Hitzebeständige Legierungen, Titanlegierungen	LP	DCMT070204-LP	0.4	●●●																																		
		DCMT070208-LP	0.8	★●●																																		
		DCMT11T304-LP	0.4	●●●																																		
		DCMT11T308-LP	0.8	●●●																																		
Leichtzerspanung	LM	DCMT070204-LM	0.4						●●																													
		DCMT070208-LM	0.8						●●																													
		DCMT11T304-LM	0.4						●●																													
		DCMT11T308-LM	0.8						●●																													
Leichtzerspanung	LS	DCMT070202-LS	0.2																																			
		DCMT070204-LS	0.4																																			
		DCMT11T302-LS	0.2																																			
		DCMT11T304-LS	0.4																																			
		DCMT11T308-LS	0.8																																			
Leichtzerspanung	LS	DCGT070201M-LS	0.08																																			
		DCGT070202M-LS	0.18																																			
		DCGT070204M-LS	0.38																																			
		DCGT11T301M-LS	0.08																																			
		DCGT11T302M-LS	0.18																																			

● = NEW

● : Lagerstandard. ★ : Lagerstandard in Japan.



# WSP DREHEN [POSITIV]



## DCMT 07 02 04- MK

Größe Dicke Eckenradius Spanbrecher  
\* Siehe Seite A002.

### ÜBERSICHT DER SPANBRECHER FÜR DIV. MATERIALGRUPPEN

Schlichtzerspanung..... Leichtzerspanung..... Mittlere Zerspanung.....

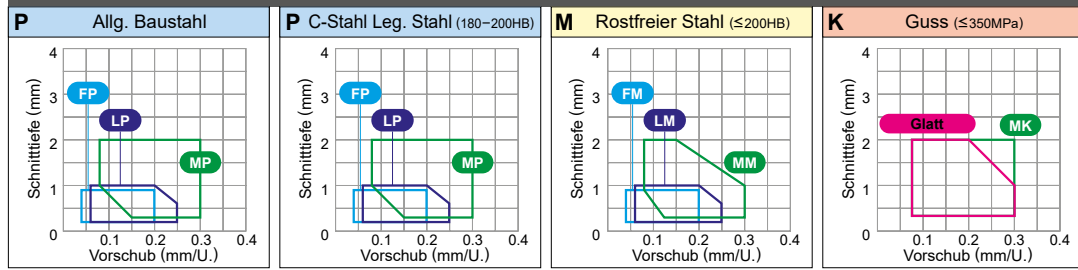

WSP DREHEN

A

Schnittbedingungen : ● : Stabile Bearbeitung ● : Allgemeine Bearbeitung ✦ : Instabile Bearbeitung

Material	Form	Bestellbezeichnung	RE (mm)	Beschichtet													Cermet	Besch. Cermet	Hartmetall		Zugehöriger Halter Seite																
				UE6105	UE6110	MC6015	MC6025	UH6400	MS6015	MC7025	MP7035	US735	US905	MC5005	MC5015	MH515			MP9005	MP9015		MP9025	MS9025	VP05RT	VP10RT	VP15TF	UP20M	NX2525	NX3035	MP3025	AP25N	VP25N	VP45N	UTI20T	HT110	RT9010	MT9005
Mittlere Zerspanung	MK	DCMT070204-MK	0.4									★	●																							C025	
		DCMT070208-MK	0.8										★	●																						D011	
		DCMT11T304-MK	0.4										●	●																						D026	
		DCMT11T308-MK	0.8										●	●																							E010
		DCMT150404-MK	0.4										★	●																							E011
Mittlere Zerspanung	MS	DCMT150408-MK	0.8									★	●																							E031	
		DCMT150412-MK	1.2										★	●																						E033	
		DCMT070204-MS	0.4												●	●	●																			C025	
		DCMT070208-MS	0.8												●	●	●																			D011	
		DCMT11T304-MS	0.4												●	●	●																			D026	
Mittlere Zerspanung	Standard	DCMT11T308-MS	0.8											●	●	●																				E010	
		DCMT11T312-MS	1.2												●	●	●																			E011	
		DCMT150404	0.4																					●	●	★	★									E031	
		DCMT150408	0.8																					●	●	★										E033	
		DCMT150412	1.2																					●	●	★											
		DCMT070202	0.2																					●	●	●	●										
		DCMT070204	0.4																					●	●	●	●										
		DCMT070208	0.8																						●	●	●	★									C025
		DCMT11T302	0.2																						●	●	●	●									D011
Mittlere Zerspanung	MV	DCMT11T304	0.4																				●	●	●	●									D026		
		DCMT11T308	0.8																				●	●	●	●									E010		
		DCMT11T312	1.2																					●	●	●	●									E011	
		DCMT150404	0.4																					●	●	●	●									E031	
		DCMT150408	0.8																					●	●	●	●									E033	
Mittlere Zerspanung	R/L-SR	DCMT11T308-MV	0.8																				●	●	●	●										E033	
		DCET0702V3R-SR	0.03																					★	★											C025	
		DCET0702V3L-SR	0.03																						★	★											D011
		DCET070201R-SR	0.1																						★	★											D026
		DCET070201L-SR	0.1																						★	★											E010
		DCET070202R-SR	0.2																						★	★											E011
		DCET070202L-SR	0.2																						★	★											E031
		DCET070204R-SR	0.4																						★	★											E033
DCET070204L-SR	0.4																						★	★													

● = NEW

● : Lagerstandard. ★ : Lagerstandard in Japan.







# WSP DREHEN [POSITIV]



**DCET 11 T3 01 L-SN**  
 Größe Dicke Eckenradius R/L Spanbrecher  
 \* Siehe Seite A002.

## ÜBERSICHT DER SPANBRECHER FÜR DIV. MATERIALGRUPPEN

Schlichtzerspanung..... Leichtzerspanung..... Mittlere Zerspanung.....

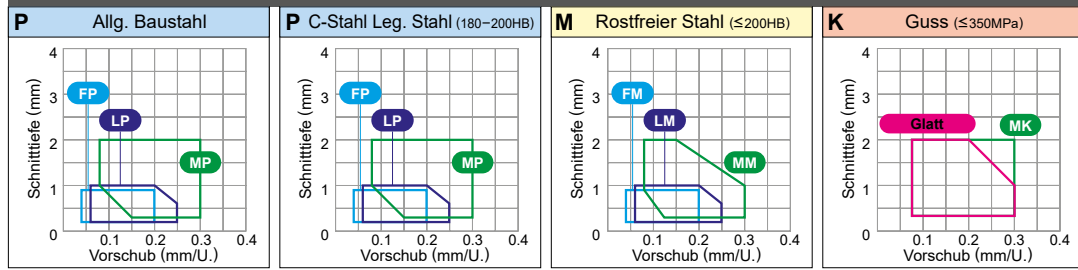

WSP DREHEN

A

Schnittbedingungen : ● : Stabile Bearbeitung ● : Allgemeine Bearbeitung ✦ : Instabile Bearbeitung

Material	Form	Bestellbezeichnung	RE (mm)	Beschichtet												Cermet	Besch. Cermet		Hartmetall		Zugehöriger Halter Seite															
				UE6105	UE6110	MC6015	MC6025	UH6400	MS6015	MC7025	MP7035	US735	US905	MC5005	MC5015		MH515	MP9005	MP9015	MP9025		MS9025	VP05RT	VP10RT	VP15TF	UP20M	NX2525	NX3035	MP3025	AP25N	VP25N	VP45N	UTI20T	HT110	RT9010	MT9005
P Stahl	R/L-SN	DCET11T301L-SN	0.1	●	●	●	●	●	●	●	●	●	●	●	●	●	●	●	●	●	●	●	●	●	●	●	●	●	●	●	●	●	●	●	●	C025
		DCET11T302R-SN	0.2	●	●	●	●	●	●	●	●	●	●	●	●	●	●	●	●	●	●	●	●	●	●	●	●	●	●	●	●	●	●	●	●	D011
		DCET11T302L-SN	0.2	●	●	●	●	●	●	●	●	●	●	●	●	●	●	●	●	●	●	●	●	●	●	●	●	●	●	●	●	●	●	●	●	D026
		DCET11T304R-SN	0.4	●	●	●	●	●	●	●	●	●	●	●	●	●	●	●	●	●	●	●	●	●	●	●	●	●	●	●	●	●	●	●	●	E010
		DCET11T304L-SN	0.4	●	●	●	●	●	●	●	●	●	●	●	●	●	●	●	●	●	●	●	●	●	●	●	●	●	●	●	●	●	●	●	●	E011
P C-Stahl Leg. Stahl	Mittlere Zerspanung	DCET11T304L-SN	0.4	●	●	●	●	●	●	●	●	●	●	●	●	●	●	●	●	●	●	●	●	●	●	●	●	●	●	●	●	●	●	●	E031	
		DCET11T304L-SN	0.4	●	●	●	●	●	●	●	●	●	●	●	●	●	●	●	●	●	●	●	●	●	●	●	●	●	●	●	●	●	●	●	E033	
		DCET0702V3RW-SN	0.03	●	●	●	●	●	●	●	●	●	●	●	●	●	●	●	●	●	●	●	●	●	●	●	●	●	●	●	●	●	●	●	C025	
		DCET0702V3LW-SN	0.03	●	●	●	●	●	●	●	●	●	●	●	●	●	●	●	●	●	●	●	●	●	●	●	●	●	●	●	●	●	●	●	D011	
P C-Stahl Leg. Stahl	Mittlere Zerspanung (Vollprofil)	DCET11T3V3RW-SN	0.03	●	●	●	●	●	●	●	●	●	●	●	●	●	●	●	●	●	●	●	●	●	●	●	●	●	●	●	●	●	●	D026		
		DCET11T3V3LW-SN	0.03	●	●	●	●	●	●	●	●	●	●	●	●	●	●	●	●	●	●	●	●	●	●	●	●	●	●	●	●	●	●	E010		
		DCET11T3V3LW-SN	0.03	●	●	●	●	●	●	●	●	●	●	●	●	●	●	●	●	●	●	●	●	●	●	●	●	●	●	●	●	●	●	●	E011	
		DCET11T3V3LW-SN	0.03	●	●	●	●	●	●	●	●	●	●	●	●	●	●	●	●	●	●	●	●	●	●	●	●	●	●	●	●	●	●	●	E031	
M Rostfreier Stahl	Mittlere Zerspanung	DCGT070201M-SMG	0.08	●	●	●	●	●	●	●	●	●	●	●	●	●	●	●	●	●	●	●	●	●	●	●	●	●	●	●	●	●	●	E033		
		DCGT070202M-SMG	0.18	●	●	●	●	●	●	●	●	●	●	●	●	●	●	●	●	●	●	●	●	●	●	●	●	●	●	●	●	●	●	●	C025	
		DCGT070204M-SMG	0.38	●	●	●	●	●	●	●	●	●	●	●	●	●	●	●	●	●	●	●	●	●	●	●	●	●	●	●	●	●	●	●	D011	
		DCGT11T301M-SMG	0.08	●	●	●	●	●	●	●	●	●	●	●	●	●	●	●	●	●	●	●	●	●	●	●	●	●	●	●	●	●	●	●	D026	
		DCGT11T302M-SMG	0.18	●	●	●	●	●	●	●	●	●	●	●	●	●	●	●	●	●	●	●	●	●	●	●	●	●	●	●	●	●	●	●	E010	
		DCGT11T304M-SMG	0.38	●	●	●	●	●	●	●	●	●	●	●	●	●	●	●	●	●	●	●	●	●	●	●	●	●	●	●	●	●	●	●	E011	
K Guss	Mittlere Zerspanung	DCMW070204	0.4	●	●	●	●	●	●	●	●	●	●	●	●	●	●	●	●	●	●	●	●	●	●	●	●	●	●	●	●	●	●	E031		
		DCMW11T304	0.4	●	●	●	●	●	●	●	●	●	●	●	●	●	●	●	●	●	●	●	●	●	●	●	●	●	●	●	●	●	●	E010		
		DCMW11T308	0.8	●	●	●	●	●	●	●	●	●	●	●	●	●	●	●	●	●	●	●	●	●	●	●	●	●	●	●	●	●	●	●	E011	
		DCMW150404	0.4	●	●	●	●	●	●	●	●	●	●	●	●	●	●	●	●	●	●	●	●	●	●	●	●	●	●	●	●	●	●	●	E031	
		DCMW150408	0.8	●	●	●	●	●	●	●	●	●	●	●	●	●	●	●	●	●	●	●	●	●	●	●	●	●	●	●	●	●	●	●	E033	
S Hitzbeständige Legierungen, Titanlegierungen	Glatt	DCGW070200	0	●	●	●	●	●	●	●	●	●	●	●	●	●	●	●	●	●	●	●	●	●	●	●	●	●	●	●	●	●	●	C025		
		DCGW0702V5	0.05	●	●	●	●	●	●	●	●	●	●	●	●	●	●	●	●	●	●	●	●	●	●	●	●	●	●	●	●	●	●	D011		
		DCGW11T300	0	●	●	●	●	●	●	●	●	●	●	●	●	●	●	●	●	●	●	●	●	●	●	●	●	●	●	●	●	●	●	D026		
		DCGW11T3V5	0.05	●	●	●	●	●	●	●	●	●	●	●	●	●	●	●	●	●	●	●	●	●	●	●	●	●	●	●	●	●	●	●	E010	
		DCGW11T304	0.4	●	●	●	●	●	●	●	●	●	●	●	●	●	●	●	●	●	●	●	●	●	●	●	●	●	●	●	●	●	●	●	E031	

\* Vor dem Einsatz des R/LW-SN-Spanbrechers (Vollprofil), beachten Sie bitte Seite A028.

● = NEW

● : Lagerstandard. ★ : Lagerstandard in Japan.  
 □ : Herstellung nur auf Anfrage.

POSITIV  
MIT LOCH

C

D

R

S

T

V



W

ÜBERSICHT DER SPANBRECHER FÜR DIV. MATERIALGRUPPEN

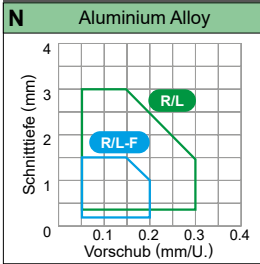
Schlichtzerspanung.....  Mittlere Zerspanung..... 

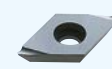

Schnittbedingungen : ● : Stabile Bearbeitung ● : Allgemeine Bearbeitung ✳ : Instabile Bearbeitung

Material	Material		Schnittbedingungen																																				
	P	M	K	N	S	Beschichtet														Cermet	Besch. Cermet	Hartmetall		Zugehöriger Halter															
Form	Bestellbezeichnung	RE (mm)	UE6105	UE6110	MC6015	MC6025	UH6400	MS6015	MC7025	MP7035	US735	US905	MC5005	MC5015	MH515	MP9005	MP9015	MP9025	MS9025	VP05RT	VP10RT	VP15TF	UP20M	NX2525	NX3035	MP3025	AP25N	VP25N	VP45N	UTi20T	HTi10	RT9010	MT9005	MT9015					
<b>R/L-F</b>  Schlichtzerspanung (Für Aluminiumleg.)	<b>DEGX150402L-F</b>	0.2																																					
	<b>DEGX150404R-F</b>	0.4																																					
	<b>DEGX150404L-F</b>	0.4																																					
<b>R/L</b>  Mittlere Zerspanung (Für Aluminiumleg.)	<b>DEGX150402R</b>	0.2																																					
	<b>DEGX150402L</b>	0.2																																					
	<b>DEGX150404R</b>	0.4																																					
	<b>DEGX150404L</b>	0.4																																					

 = NEW

**A**

WSP DREHEN

**POSI 20°**

MIT LOCH

**C**

**D**

**R**

**S**

**T**

**V**

**W**



### ÜBERSICHT DER SPANBRECHER FÜR DIV. MATERIALGRUPPEN

Schlichtzerspanung..... Leichtzerspanung..... Mittlere Zerspanung.....

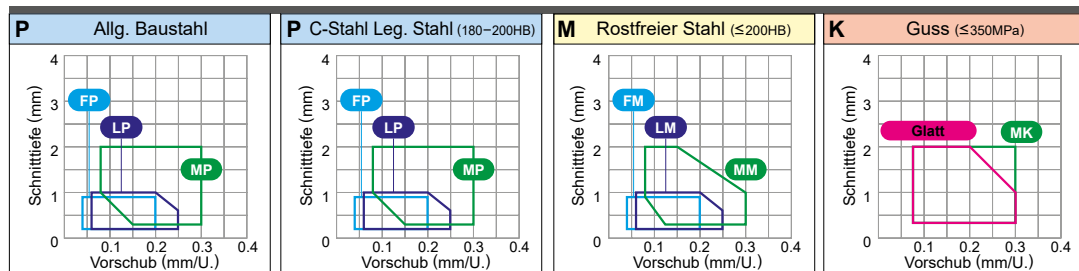

Schnittbedingungen : ● : Stabile Bearbeitung ● : Allgemeine Bearbeitung ✦ : Instabile Bearbeitung

Form	Bestellbezeichnung	RE (mm)	Beschichtet												Cermet	Besch. Cermet	Hartmetall			Zugehöriger Halter Seite														
			UE6105	UE6110	MC6015	MC6025	UH6400	MS6015	MC7025	MP7035	US735	US905	MC5005	MC5015	MH515	MP9005	MP9015	MP9025	MS9025		VP05RT	VP10RT	VP15TF	UP20M	NX2525	NX3035	MP3025	AP25N	VP25N	VP45N	UTI20T	HT110	RT9010	MT9005
<b>FP</b>  Schlichtzerspanung	SCMT09T304-FP	0.4	★	●	●																			★		★								
	SCMT09T308-FP	0.8	★	●	●																				★		★							
<b>FM</b>  Schlichtzerspanung	SCMT09T304-FM	0.4																		●														
	SCMT09T308-FM	0.8																		●														
<b>FV</b>  Schlichtzerspanung	SCMT09T304-FV	0.4																						★	●		★	★						
<b>LP</b>  Leichtzerspanung	SCMT09T304-LP	0.4	●	●	●																			★		★								
	SCMT09T308-LP	0.8	★	●	●																				●		★							
<b>LM</b>  Leichtzerspanung	SCMT09T304-LM	0.4								★	★									●														
	SCMT09T308-LM	0.8								★	★									●														
<b>MP</b>  Mittlere Zerspanung	SCMT09T304-MP	0.4	★	●	●																			★		★								
	SCMT09T308-MP	0.8	●	●	●																				★		●							
	SCMT120404-MP	0.4	★	●	●																				★		★							
	SCMT120408-MP	0.8	★	●	●																				★		●							
<b>MM</b>  Mittlere Zerspanung	SCMT09T304-MM	0.4								●	★									●														
	SCMT09T308-MM	0.8								●	★									●														
	SCMT120404-MM	0.4								●	★									●														
	SCMT120408-MM	0.8								●	●									●														

● = NEW





# WSP DREHEN [POSITIV]



TCMT 09 02 02- FP

Größe Dicke Eckenradius Spanbrecher  
\* Siehe Seite A002.

## ÜBERSICHT DER SPANBRECHER FÜR DIV. MATERIALGRUPPEN

Schlichtzerspanung.....

Leichtzerspanung.....

Mittlere Zerspanung.....

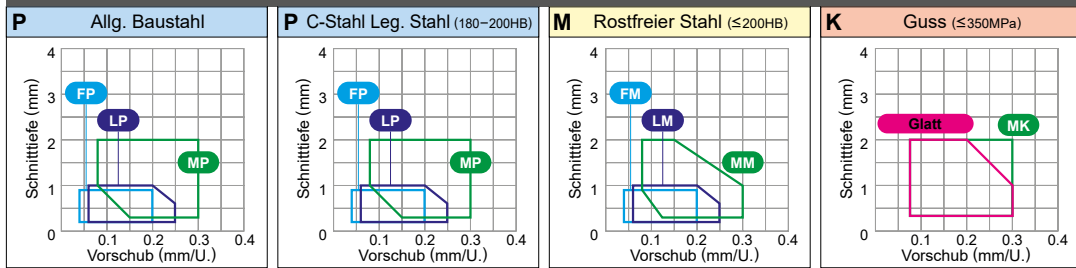

Schnittbedingungen : ● : Stabile Bearbeitung ● : Allgemeine Bearbeitung ✦ : Instabile Bearbeitung

Material	P	M	K	N	S																																									
	Stahl	Rostfreier Stahl	Guss	Nicht-Eisen-Metalle	Hitzeständige Legierungen, Titanlegierungen																																									
Form	Bestellbezeichnung	RE (mm)	Beschichtet							Cermet	Besch. Cermet	Hartmetall		Zugehöriger Halter Seite																																
			UE6105	UE6110	MC6015	MC6025	UH6400	MS6015	MC7025	MP7035	US735	US905	MC5005	MC5015	MH515	MP9005	MP9015	MP9025	MS9025	VP05RT	VP10RT	VP15TF	UP20M	NX2525	NX3035	MP3025	AP25N	VP25N	VP45N	UTI20T	HT110	RT9010	MT9005	MT9015												
<b>FP</b> 	TCMT090202-FP	0.2	★	●	●																				★		★																			
	TCMT090204-FP	0.4	★	●	●																					●		●																		
	TCMT110202-FP	0.2	★	●	●																					★		●																		
	TCMT110204-FP	0.4	●	●	●																					★		●																		
	TCMT16T304-FP	0.4	●	●	●																					●		●																		
<b>FM</b> 	TCMT090202-FM	0.2																				★																								
	TCMT090204-FM	0.4																				●																								
	TCMT110202-FM	0.2																				●																								
	TCMT110204-FM	0.4																				●																								
<b>FV</b> 	TCMT110204-FV	0.4																							●	●		●																		
	TCMT16T304-FV	0.4																							●	●		●																		
<b>AZ</b> 	TCGT110202-AZ	0.2																																												
	TCGT110204-AZ	0.4																																												
	TCGT110208-AZ	0.8																																												
	TCGT16T302-AZ	0.2																																												
	TCGT16T304-AZ	0.4																																												
	TCGT16T308-AZ	0.8																																												
<b>R/L-F</b> 	TCGT0601V3L-F	0.03																							★																					
	TCGT060101L-F	0.1																							●	●																				
	TCGT060102R-F	0.2																							★	★																				
	TCGT060102L-F	0.2																							●	●																				
	TCGT060104R-F	0.4																							●	●																				
	TCGT060104L-F	0.4																							●	●																				
	NEW TCGT060101MR-F	0.08																																												
	NEW TCGT060101ML-F	0.08																																												
	NEW TCGT060102MR-F	0.18																																												

● = NEW

● : Lagerstandard. ★ : Lagerstandard in Japan.





# WSP DREHEN [POSITIV]



**TCMT 08 02 04**

Größe Dicke Eckenradius

\* Siehe Seite A002.

## ÜBERSICHT DER SPANBRECHER FÜR DIV. MATERIALGRUPPEN

Schlichtzerspanung.....

Leichtzerspanung.....

Mittlere Zerspanung.....

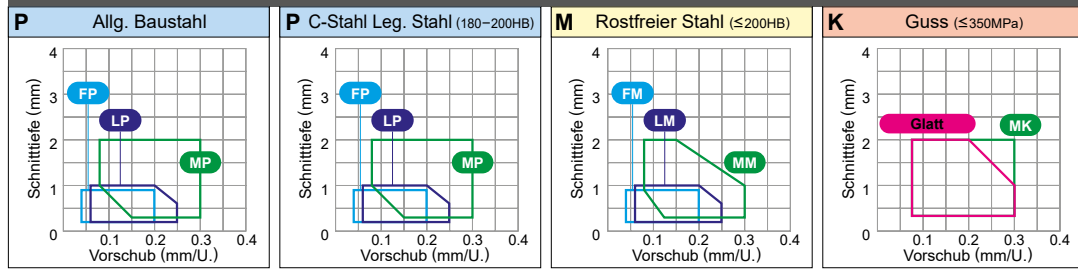

WSP DREHEN

A

Schnittbedingungen : ● : Stabile Bearbeitung ● : Allgemeine Bearbeitung ✦ : Instabile Bearbeitung

Material	P Stahl	M Rostfreier Stahl	K Guss	N Nicht-Eisen-Metalle	S Hitzebeständige Legierungen, Titanlegierungen	Schnittbedingungen																										
						●	●	●	●	●	●	●	●	●	●	●	●	●	●	●	●											
Form	Bestellbezeichnung	RE (mm)	Beschichtet										Cermet		Besch. Cermet		Hartmetall		Zugehöriger Halter Seite													
			UE6105	UE6110	MC6015	UH6400	MS6015	MC7025	MP7035	US735	US905	MC5005	MC5015	MH515	MP9005	MP9015	MP9025	MS9025		VP05RT	VP10RT	VP15TF	UP20M	NX2525	NX3035	MP3025	AP25N	VP25N	VP45N	UTi20T	HTi10	RT9010
Standard	TCMT080204	0.4																					●	●			●					
	TCMT090204	0.4	●						★														●	●	★	●		●				
	TCMT110202	0.2	●						●														★	●	★	★						
	TCMT110204	0.4	★	●					●														●	●	●	★		●				
	TCMT110208	0.8	★	●																			★		●							
	TCMT130302	0.2																							★	★						
	TCMT130304	0.4	●							●														●	★							
	TCMT16T304	0.4	●	●						●													★	●	●	★		●				
Mittlere Zerspanung	TCMT16T308	0.8	●	●					●														●	●	★		●					
Glatt	TCMW110204	0.4								●	●																				●	
	TCMW130304	0.4																												★		
	TCMW16T304	0.4								●	●																			●		
	TCMW16T308	0.8								●	●																			●		
	TCMW16T312	1.2								★	★																					

● = NEW

● : Lagerstandard. ★ : Lagerstandard in Japan.

### ÜBERSICHT DER SPANBRECHER FÜR DIV. MATERIALGRUPPEN

Mittlere Zerspanung.....

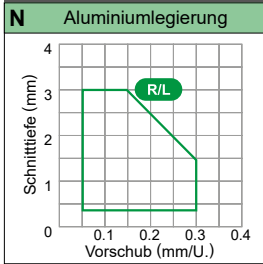

Schnittbedingungen : ● : Stabile Bearbeitung ● : Allgemeine Bearbeitung ✦ : Instabile Bearbeitung

Material	P	Stahl	●	●	●	✦	●	Form	Bestellbezeichnung	RE (mm)	Beschichtet										Cermet	Besch. Cermet	Hartmetall			Zugehöriger Halter Seite																								
	M	Rostfreier Stahl	●	●	✦	●	●				●	●	●	●	●	●	●	●	●	●	●	●	●	●	●		●	●																						
<b>N</b> Aluminiumlegierung  Mittlere Zerspanung (Für Aluminiumleg.)	K	Guss									UE6105	UE6110	MC6015	MC6025	UH6400	MS6015	MC7025	MP7035	US735	US905	MC5005	MC5015	MH515	MP9005	MP9015	MP9025	MS9025	VP05RT	VP10RT	VP15TF	UP20M	NX2525	NX3035	MP3025	AP25N	VP25N	VP45N	UTI20T	HT110	RT9010	MT9005	MT9015								
	S	Hitzebeständige Legierungen, Titanlegierungen																																																

● = NEW

A

WSP DREHEN

POSI 20°

MIT LOCH

C

D

R

S

T

V

W





# WSP DREHEN [POSITIV]



## VBMT 11 03 02-FP

Größe Dicke Eckenradius Spanbrecher  
\* Siehe Seite A002.

### ÜBERSICHT DER SPANBRECHER FÜR DIV. MATERIALGRUPPEN

Schlichtzerspanung.....

Leichtzerspanung.....

Mittlere Zerspanung.....

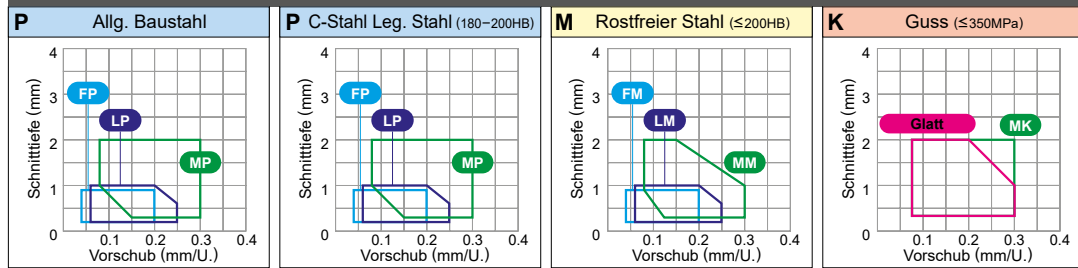

WSP DREHEN

A

Schnittbedingungen : ● : Stabile Bearbeitung ● : Allgemeine Bearbeitung ✦ : Instabile Bearbeitung

Material	P Stahl		M Rostfreier Stahl		K Guss		N Nicht-Eisen-Metalle		S Hitzebeständige Legierungen, Titanlegierungen																												
	Beschichtet										Cermet	Besch. Cermet		Hartmetall		Zugehöriger Halter Seite																					
	Form	Bestellbezeichnung	RE (mm)	UE6105	UE6110	MC6015	MC6025	UH6400	MS6015	MC7025	MP7035	US735	US905	MC5005	MC5015		MH515	MP9005	MP9015	MP9025	MS9025	VP05RT	VP10RT	VP15TF	UP20M	NX2525	NX3035	MP3025	AP25N	VP25N	VP45N	UTI20T	HT110	RT9010	MT9005	MT9015	
<b>FP</b> 	VBMT110302-FP	0.2	●●●																																		D010
	VBMT110304-FP	0.4	●●●																																	D013	
	VBMT110308-FP	0.8	★●●																																	E013	
	VBMT160404-FP	0.4	●●●																																	E014	
Schlichtzerspanung	VBMT160408-FP	0.8	●●●																																	H013	
<b>FM</b> 	VBMT110302-FM	0.2																																		D010	
	VBMT110304-FM	0.4																																		D013	
	VBMT110308-FM	0.8																																		E013	
	VBMT160404-FM	0.4																																		E014	
Schlichtzerspanung	VBMT160408-FM	0.8																																		H013	
<b>FV</b> 	VBMT110304-FV	0.4																																		D010	
	VBMT110308-FV	0.8																																		D013	
	VBMT160404-FV	0.4																																			E013
Schlichtzerspanung	VBMT160408-FV	0.8																																			E014
																																				H013	
<b>R/L-F</b> 	VBGT110302R-F	0.2																																			
	VBGT110302L-F	0.2																																			
	VBGT110304R-F	0.4																																			
	VBGT110304L-F	0.4																																			
	VBGT160402R-F	0.2																																			
	VBGT160402L-F	0.2																																			
	VBGT160404R-F	0.4																																			
Schlichtzerspanung	VBGT160404L-F	0.4																																			
<b>LP</b> 	VBMT110304-LP	0.4	★●●																																		
	VBMT110308-LP	0.8	●●●																																		
	VBMT160404-LP	0.4	●●●																																		
Leichtzerspanung	VBMT160408-LP	0.8	●●●																																		
<b>LM</b> 	VBMT110304-LM	0.4							●●																												
	VBMT110308-LM	0.8							★★																												
	VBMT160404-LM	0.4							●●																												
Leichtzerspanung	VBMT160408-LM	0.8							●★																												

● = NEW

● : Lagerstandard. ★ : Lagerstandard in Japan.





















### ÜBERSICHT DER SPANBRECHER FÜR DIV. MATERIALGRUPPEN

Mittlere Zerspanung.....

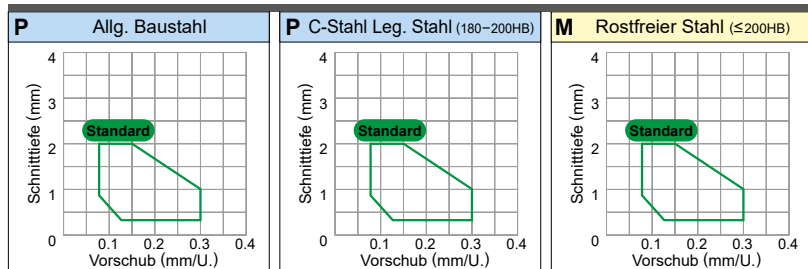

Schnittbedingungen : ● : Stabile Bearbeitung ● : Allgemeine Bearbeitung ✱ : Instabile Bearbeitung

Form	Bestellbezeichnung	RE (mm)	Beschichtet													Cermet	Besch. Cermet	Hartmetall			Zugehöriger Halter Seite															
			UE6105	UE6110	MC6015	MC6025	UH6400	MS6015	MC7025	MP7035	US735	US905	MC5005	MC5015	MH515 NEW	MP9005	MP9015	MP9025 NEW	MS9025	VP05RT		VP10RT	VP15TF	UP20M	NX2525	NX3035	MP3025	AP25N	VP25N	VP45N	UTI20T	HT110	RT9010	MT9005	MT9015	
<b>R/L</b> 	WCGT020102R	0.2																					●													
	WCGT020102L	0.2																						●												
	WCGT020104R	0.4																						●												
	WCGT020104L	0.4																						●												
	WCGTL30202L	0.2																						●												
	WCGTL30204L	0.4																						●												
<b>Standard</b> 	WCMT020102	0.2	✱							●													●	●	●	●	●	●	●	●	●	●	●	●	●	
	WCMT020104	0.4	✱							●													●	●	●	●	●	●	●	●	●	●	●	●	●	
	WCMTL30202	0.2	✱							●													●	●	●	●	●	●	●	●	●	●	●	●	●	
	WCMTL30204	0.4	✱							●													●	●	●	●	●	●	●	●	●	●	●	●	●	
	WCMT040202	0.2	✱							●													●	●	●	●	●	●	●	●	●	●	●	●	●	
	WCMT040204	0.4	✱							●													●	●	●	●	●	●	●	●	●	●	●	●	●	
	WCMT06T304	0.4	✱							●													●	●	●	●	●	●	●	●	●	●	●	●	●	
Mittlere Zerspanung	WCMT06T308	0.8	✱						●													●	●	●	●	●	●	●	●	●	●	●	●	●		

● = NEW

WSP DREHEN

POSITIONEN  
MIT LOCH

C

D

R

S

T

V

W

# WSP DREHEN [POSITIV]



## WP AUSFÜHRUNG WSP MIT LOCH

**WPGT 04 02 04 R- FS**

Größe Dicke Eckenradius R/LSpanbrecher  
\* Siehe Seite A002.

### ÜBERSICHT DER SPANBRECHER FÜR DIV. MATERIALGRUPPEN

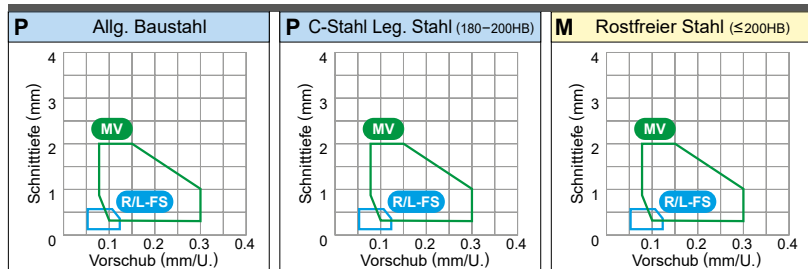

Schlichtzerspanung..... ● Mittlere Zerspanung..... ●



WSP DREHEN

A

Schnittbedingungen : ● : Stabile Bearbeitung ● : Allgemeine Bearbeitung ✦ : Instabile Bearbeitung

Material	P	M	K	N	S	Beschichtet														Cermet	Besch. Cermet	Hartmetall		Zugehöriger Halter Seite												
	Stahl	Rostfreier Stahl	Guss	Nicht-Eisen-Metalle	Hitzebeständige Legierungen, Titanlegierungen	UE6105	UE6110	MC6015	MC6025	UH6400	MS6015	MC7025	MP7035	US735	US905	MC5005	MC5015	MH515	MP9005	MP9015	MP9025	MS9025	VP05RT		VP10RT	VP15TF	UP20M	NX2525	NX3035	MP3025	AP25N	VP25N	VP45N	UTi20T	HTi10	RT9010
Form	Bestellbezeichnung	RE (mm)																																		
R/L-FS 	WPGT040204R-FS	0.4																																		
	WPGT040204L-FS	0.4																																		
	WPGT060304R-FS	0.4																																		
	WPGT060304L-FS	0.4																																		
Schlichtzerspanung																																				
MV 	WPMT040202-MV	0.2																																		
	WPMT040204-MV	0.4																																		
	WPMT060304-MV	0.4																																		
	WPMT060308-MV	0.8																																		
Mittlere Zerspanung																																				

● = NEW

POSITIV  
MIT  
LOCH

C

D

R

S

T

V

W

● : Lagerstandard. ★ : Lagerstandard in Japan.

















# Notizen

---

A series of horizontal dashed lines for taking notes, spanning the width of the page.

# Notizen

---

A series of horizontal dashed lines for writing notes, spanning the width of the page.

# ALLGEMEINE ERKLÄRUNG: DREHEN PCBN- & PKD-WENDESCHNEIDPLATTEN

## Wie sind die Seiten dieses Kapitels aufgebaut

1. Aufgelistet nach der Form der Drehwendeplatte.  
(Beachten Sie das Inhaltsverzeichnis auf der nächsten Seite.)
2. Wendeschneidplatten sind aufgelistet nach :
  - Negative WSP (mit Loch → ohne Loch)
  - Positive WSP (mit Loch → ohne Loch)

### EMPFOHLENER SORTEN-DREH-ANWENDUNGSBEREICH FÜR DIE JEWEILIGEN WERKSTÜCKE

Geeignete Schnittbedingungen für unterschiedlichste Werkstücke werden in einer allg. Übersicht der Sorten dargelegt.

● : Stabile Bearbeitung ● : Allgemeine Bearbeitung ✖ : Instabile Bearbeitung



**PCBN-WSP FÜR DAS DREHEN (NEGATIV)**  
**80° CN AUSFÜHRUNG WSP MIT LOCH**

Werkstoff	Form	Bestellbezeichnung	Beschichtet PCBN	PCBN	Abmessungen (mm)					Abbildung	Zugehöriger Halter/Seite
					IC	S	RE	LE	D1		
K Guß	A	NP-CNGA120404GS4	●●●●	●●●●	12,7	7,6	0,4	1,8	5,16		C008 E015 E038 H008 -008
		NP-CNGA120408GS4	●●●●	●●●●	12,7	7,6	0,8	2,0	5,16		
		NP-CNGA120412GS4	●●●●	●●●●	12,7	7,6	1,2	2,2	5,16		
		NP-CNGA120416GS4	●●●●	●●●●	12,7	7,6	1,6	2,2	5,16		
		NP-CNGA120420GS4	●●●●	●●●●	12,7	7,6	2,0	2,2	5,16		
		NP-CNGA120424GS4	●●●●	●●●●	12,7	7,6	2,4	2,2	5,16		
		NP-CNGA120428GS4	●●●●	●●●●	12,7	7,6	2,8	2,0	5,16		
		NP-CNGA120432GS4	●●●●	●●●●	12,7	7,6	3,2	2,0	5,16		
		NP-CNGA120436GS4	●●●●	●●●●	12,7	7,6	3,6	2,0	5,16		
		NP-CNGA120440GS4	●●●●	●●●●	12,7	7,6	4,0	2,0	5,16		
		NP-CNGA120444GS4	●●●●	●●●●	12,7	7,6	4,4	2,0	5,16		
		NP-CNGA120448GS4	●●●●	●●●●	12,7	7,6	4,8	2,0	5,16		
		NP-CNGA120452GS4	●●●●	●●●●	12,7	7,6	5,2	2,0	5,16		
		NP-CNGA120456GS4	●●●●	●●●●	12,7	7,6	5,6	2,0	5,16		
		NP-CNGA120460GS4	●●●●	●●●●	12,7	7,6	6,0	2,0	5,16		
		NP-CNGA120464GS4	●●●●	●●●●	12,7	7,6	6,4	2,0	5,16		
		NP-CNGA120468GS4	●●●●	●●●●	12,7	7,6	6,8	2,0	5,16		
		NP-CNGA120472GS4	●●●●	●●●●	12,7	7,6	7,2	2,0	5,16		
NP-CNGA120476GS4	●●●●	●●●●	12,7	7,6	7,6	2,0	5,16				
NP-CNGA120480GS4	●●●●	●●●●	12,7	7,6	8,0	2,0	5,16				
NP-CNGA120484GS4	●●●●	●●●●	12,7	7,6	8,4	2,0	5,16				
NP-CNGA120488GS4	●●●●	●●●●	12,7	7,6	8,8	2,0	5,16				
NP-CNGA120492GS4	●●●●	●●●●	12,7	7,6	9,2	2,0	5,16				
NP-CNGA120496GS4	●●●●	●●●●	12,7	7,6	9,6	2,0	5,16				
NP-CNGA120500GS4	●●●●	●●●●	12,7	7,6	10,0	2,0	5,16				
NP-CNGA120412FS4	●●●●	●●●●	12,7	7,6	1,2	2,2	5,16				
NP-CNGA120416FS4	●●●●	●●●●	12,7	7,6	1,6	2,2	5,16				
NP-CNGA120420FS4	●●●●	●●●●	12,7	7,6	2,0	2,2	5,16				
NP-CNGA120424FS4	●●●●	●●●●	12,7	7,6	2,4	2,2	5,16				
NP-CNGA120428FS4	●●●●	●●●●	12,7	7,6	2,8	2,2	5,16				
NP-CNGA120432FS4	●●●●	●●●●	12,7	7,6	3,2	2,2	5,16				
NP-CNGA120436FS4	●●●●	●●●●	12,7	7,6	3,6	2,2	5,16				
NP-CNGA120440FS4	●●●●	●●●●	12,7	7,6	4,0	2,2	5,16				
NP-CNGA120444FS4	●●●●	●●●●	12,7	7,6	4,4	2,2	5,16				
NP-CNGA120448FS4	●●●●	●●●●	12,7	7,6	4,8	2,2	5,16				
NP-CNGA120452FS4	●●●●	●●●●	12,7	7,6	5,2	2,2	5,16				
NP-CNGA120456FS4	●●●●	●●●●	12,7	7,6	5,6	2,2	5,16				
NP-CNGA120460FS4	●●●●	●●●●	12,7	7,6	6,0	2,2	5,16				
NP-CNGA120464FS4	●●●●	●●●●	12,7	7,6	6,4	2,2	5,16				
NP-CNGA120468FS4	●●●●	●●●●	12,7	7,6	6,8	2,2	5,16				
NP-CNGA120472FS4	●●●●	●●●●	12,7	7,6	7,2	2,2	5,16				
NP-CNGA120476FS4	●●●●	●●●●	12,7	7,6	7,6	2,2	5,16				
NP-CNGA120480FS4	●●●●	●●●●	12,7	7,6	8,0	2,2	5,16				
NP-CNGA120484FS4	●●●●	●●●●	12,7	7,6	8,4	2,2	5,16				
NP-CNGA120488FS4	●●●●	●●●●	12,7	7,6	8,8	2,2	5,16				
NP-CNGA120492FS4	●●●●	●●●●	12,7	7,6	9,2	2,2	5,16				
NP-CNGA120496FS4	●●●●	●●●●	12,7	7,6	9,6	2,2	5,16				
NP-CNGA120500FS4	●●●●	●●●●	12,7	7,6	10,0	2,2	5,16				

Werkstoff	Form	Bestellbezeichnung	Beschichtet PCBN	PCBN	Abmessungen (mm)					Abbildung	Zugehöriger Halter/Seite
					IC	S	RE	LE	D1		
K Guß	A	NP-CNGA120402GS2	●●●●	●●●●	12,7	7,6	0,2	1,7	5,16		C008 E015 E038 H008 -008
		NP-CNGA120404GS2	●●●●	●●●●	12,7	7,6	0,4	1,8	5,16		
		NP-CNGA120408GS2	●●●●	●●●●	12,7	7,6	0,8	2,0	5,16		
		NP-CNGA120412GS2	●●●●	●●●●	12,7	7,6	1,2	2,2	5,16		
		NP-CNGA120416GS2	●●●●	●●●●	12,7	7,6	1,6	2,2	5,16		
		NP-CNGA120420GS2	●●●●	●●●●	12,7	7,6	2,0	2,2	5,16		
		NP-CNGA120424GS2	●●●●	●●●●	12,7	7,6	2,4	2,2	5,16		
		NP-CNGA120428GS2	●●●●	●●●●	12,7	7,6	2,8	2,0	5,16		
		NP-CNGA120432GS2	●●●●	●●●●	12,7	7,6	3,2	2,0	5,16		
		NP-CNGA120436GS2	●●●●	●●●●	12,7	7,6	3,6	2,0	5,16		
		NP-CNGA120440GS2	●●●●	●●●●	12,7	7,6	4,0	2,0	5,16		
		NP-CNGA120444GS2	●●●●	●●●●	12,7	7,6	4,4	2,0	5,16		
		NP-CNGA120448GS2	●●●●	●●●●	12,7	7,6	4,8	2,0	5,16		
		NP-CNGA120452GS2	●●●●	●●●●	12,7	7,6	5,2	2,0	5,16		
		NP-CNGA120456GS2	●●●●	●●●●	12,7	7,6	5,6	2,0	5,16		
		NP-CNGA120460GS2	●●●●	●●●●	12,7	7,6	6,0	2,0	5,16		
		NP-CNGA120464GS2	●●●●	●●●●	12,7	7,6	6,4	2,0	5,16		
		NP-CNGA120468GS2	●●●●	●●●●	12,7	7,6	6,8	2,0	5,16		
NP-CNGA120472GS2	●●●●	●●●●	12,7	7,6	7,2	2,0	5,16				
NP-CNGA120476GS2	●●●●	●●●●	12,7	7,6	7,6	2,0	5,16				
NP-CNGA120480GS2	●●●●	●●●●	12,7	7,6	8,0	2,0	5,16				
NP-CNGA120484GS2	●●●●	●●●●	12,7	7,6	8,4	2,0	5,16				
NP-CNGA120488GS2	●●●●	●●●●	12,7	7,6	8,8	2,0	5,16				
NP-CNGA120492GS2	●●●●	●●●●	12,7	7,6	9,2	2,0	5,16				
NP-CNGA120496GS2	●●●●	●●●●	12,7	7,6	9,6	2,0	5,16				
NP-CNGA120500GS2	●●●●	●●●●	12,7	7,6	10,0	2,0	5,16				
NP-CNGA120402FS2	●●●●	●●●●	12,7	7,6	0,2	1,7	5,16				
NP-CNGA120404FS2	●●●●	●●●●	12,7	7,6	0,4	1,8	5,16				
NP-CNGA120408FS2	●●●●	●●●●	12,7	7,6	0,8	2,0	5,16				
NP-CNGA120412FS2	●●●●	●●●●	12,7	7,6	1,2	2,2	5,16				
NP-CNGA120416FS2	●●●●	●●●●	12,7	7,6	1,6	2,2	5,16				
NP-CNGA120420FS2	●●●●	●●●●	12,7	7,6	2,0	2,2	5,16				
NP-CNGA120424FS2	●●●●	●●●●	12,7	7,6	2,4	2,2	5,16				
NP-CNGA120428FS2	●●●●	●●●●	12,7	7,6	2,8	2,0	5,16				
NP-CNGA120432FS2	●●●●	●●●●	12,7	7,6	3,2	2,0	5,16				
NP-CNGA120436FS2	●●●●	●●●●	12,7	7,6	3,6	2,0	5,16				
NP-CNGA120440FS2	●●●●	●●●●	12,7	7,6	4,0	2,0	5,16				
NP-CNGA120444FS2	●●●●	●●●●	12,7	7,6	4,4	2,0	5,16				
NP-CNGA120448FS2	●●●●	●●●●	12,7	7,6	4,8	2,0	5,16				
NP-CNGA120452FS2	●●●●	●●●●	12,7	7,6	5,2	2,0	5,16				
NP-CNGA120456FS2	●●●●	●●●●	12,7	7,6	5,6	2,0	5,16				
NP-CNGA120460FS2	●●●●	●●●●	12,7	7,6	6,0	2,0	5,16				
NP-CNGA120464FS2	●●●●	●●●●	12,7	7,6	6,4	2,0	5,16				
NP-CNGA120468FS2	●●●●	●●●●	12,7	7,6	6,8	2,0	5,16				
NP-CNGA120472FS2	●●●●	●●●●	12,7	7,6	7,2	2,0	5,16				
NP-CNGA120476FS2	●●●●	●●●●	12,7	7,6	7,6	2,0	5,16				
NP-CNGA120480FS2	●●●●	●●●●	12,7	7,6	8,0	2,0	5,16				
NP-CNGA120484FS2	●●●●	●●●●	12,7	7,6	8,4	2,0	5,16				
NP-CNGA120488FS2	●●●●	●●●●	12,7	7,6	8,8	2,0	5,16				
NP-CNGA120492FS2	●●●●	●●●●	12,7	7,6	9,2	2,0	5,16				
NP-CNGA120496FS2	●●●●	●●●●	12,7	7,6	9,6	2,0	5,16				
NP-CNGA120500FS2	●●●●	●●●●	12,7	7,6	10,0	2,0	5,16				

B036 ● : Lagerstandard. \* : Lagerstandard in Japan.

SORTEN IDENTIFIKATION → B004 → B002 B037

**LEGENDE FÜR LAGERSYMBOLS**  
Wird auf jeder Doppelseite auf der linken Seite gezeigt.

**ABBILDUNG der WSP**

**PRODUKTBEZEICHNUNG**

**QUERVERWEIS AUF ANDERE SEITEN**  
• SPANBRECHER  
• SORTEN  
• TECHNISCHE DATEN  
Wird als Querverweis auf der rechten Seite einer jeden Doppelseite angezeigt.

**ZUGEHÖRIGER HALTER/SEITE**  
Zeigt den Querverweis auf die jeweils zugehörigen Halter.

**DIE ABBILDUNG ZEIGT DIE WSP-AUSFÜHRUNG**  
IC: Innenkreis-Durchmesser  
S: Dicke  
RE: Eckenradius  
D1: Bohrungsdurchmesser  
LE: Effektive Länge Schneidkante  
Die Maße sind detailliert in der Spalte „Abmessungen“ aufgelistet.

# DREHEN

## WENDESCHNEIDPLATTEN PCBN- & PKD-SORTEN

IDENTIFIKATION .....	B002
KLASSIFIKATION VON PCBN- UND PKD-SORTEN .....	B004
PCBN (KUBISCHES BORNITRID) .....	B006
PKD (GESINTETER DIAMANT) .....	B028
KLASSIFIKATION VON PCBN & PKD WSP .....	B030

### STANDARD PCBN-WENDESCHNEIDPLATTEN

#### NEGATIVE WSP MIT LOCH

CN○○AUSFÜHRUNG···RHOMBUS 80° ··· B036  
DN○○AUSFÜHRUNG···RHOMBUS 55° ··· B039  
SN○○AUSFÜHRUNG···VIERKANT 90° ··· B043  
TN○○AUSFÜHRUNG···DREIKANT 60° ··· B044  
VN○○AUSFÜHRUNG···RHOMBUS 35° ··· B046  
WN○○AUSFÜHRUNG···SECHSKANT 80° ··· B048

#### NEGATIVE WSP OHNE LOCH

CN○○AUSFÜHRUNG···RHOMBUS 80° ··· B049  
DN○○AUSFÜHRUNG···RHOMBUS 55° ··· B049  
RN○○AUSFÜHRUNG···ROUND .....

#### POSITIVE WENDESCHNEIDPLATTEN MIT LOCH

CC○○AUSFÜHRUNG···RHOMBUS 80° ··· B051  
CP○○AUSFÜHRUNG···RHOMBUS 80° ··· B053  
DC○○AUSFÜHRUNG···RHOMBUS 55° ··· B054  
TC○○AUSFÜHRUNG···DREIKANT 60° ··· B056  
TP○○AUSFÜHRUNG···DREIKANT 60° ··· B057  
VB○○AUSFÜHRUNG···RHOMBUS 35° ··· B059  
VC○○AUSFÜHRUNG···RHOMBUS 35° ··· B060  
WC○○AUSFÜHRUNG···SECHSKANT 80° ··· B060

#### POSITIVE WENDESCHNEIDPLATTEN OHNE LOCH

SP○○AUSFÜHRUNG···VIERKANT 90° ··· B061  
TB○○AUSFÜHRUNG···DREIKANT 60° ··· B062  
TP○○AUSFÜHRUNG···DREIKANT 60° ··· B062  
GY AUSFÜHRUNG .....

### STANDARD PKD-WENDESCHNEIDPLATTEN

#### NEGATIVE WSP MIT LOCH

CN○○AUSFÜHRUNG···RHOMBUS 80° ··· B064  
DN○○AUSFÜHRUNG···RHOMBUS 55° ··· B064  
SN○○AUSFÜHRUNG···VIERKANT 90° ··· B065  
TN○○AUSFÜHRUNG···DREIKANT 60° ··· B065  
VN○○AUSFÜHRUNG···RHOMBUS 35° ··· B066

#### POSITIVE WENDESCHNEIDPLATTEN MIT LOCH

CC○○AUSFÜHRUNG···RHOMBUS 80° ··· B067  
CP○○AUSFÜHRUNG···RHOMBUS 80° ··· B067  
DC○○AUSFÜHRUNG···RHOMBUS 55° ··· B068  
SP○○AUSFÜHRUNG···VIERKANT 90° ··· B068  
TC○○AUSFÜHRUNG···DREIKANT 60° ··· B069  
TP○○AUSFÜHRUNG···DREIKANT 60° ··· B070  
VB○○AUSFÜHRUNG···RHOMBUS 35° ··· B071  
VC○○AUSFÜHRUNG···RHOMBUS 35° ··· B071  
WC○○AUSFÜHRUNG···TRIGON 80° ··· B072  
WP○○AUSFÜHRUNG···TRIGON 80° ··· B072  
DE○○AUSFÜHRUNG···RHOMBUS 55° ··· B073  
TE○○AUSFÜHRUNG···DREIKANT 60° ··· B073  
VD○○AUSFÜHRUNG···RHOMBUS 35° ··· B074

#### POSITIVE WENDESCHNEIDPLATTEN OHNE LOCH

SP○○AUSFÜHRUNG···VIERKANT 90° ··· B075  
TP○○AUSFÜHRUNG···DREIKANT 60° ··· B075

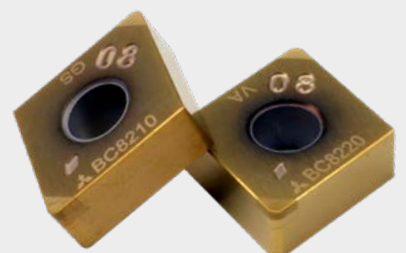

# IDENTIFIKATION

PCBN- & PKD- WSP FÜR DAS DREHEN

B

Symbol	Toleranz ohne Radius M (mm)	Toleranz des Innkreises IC (mm)	Dickentoleranz S (mm)			
<b>G</b>	±0.025	±0.025	±0.13			
<b>M*</b>	±0.08–±0.18	±0.05–±0.15	±0.13			
Die * Markierung bezeichnet gesinterte Wendeschneidplatten.						
Detailtoleranzen für M-Klasse-WSP						
● Toleranz ohne Radius M (mm)						
Innkreis	Dreikant	Vierkant	Rhombus 80°	Rhombus 55°	Rhombus 35°	Rund
<b>6.35</b>	±0.08	±0.08	±0.08	±0.11	±0.16	—
<b>9.525</b>	±0.08	±0.08	±0.08	±0.11	±0.16	—
<b>12.70</b>	±0.13	±0.13	±0.13	±0.15	—	—
● Toleranz des Innenkreises IC (mm)						
Innkreis	Dreikant	Vierkant	Rhombus 80°	Rhombus 55°	Rhombus 35°	Rund
<b>6.35</b>	±0.05	±0.05	±0.05	±0.05	±0.05	—
<b>9.525</b>	±0.05	±0.05	±0.05	±0.05	±0.05	±0.05
<b>12.70</b>	±0.08	±0.08	±0.08	±0.08	—	±0.08
<b>④ Toleranzklasse</b>						

<b>BM</b>	Mit Spanbrecher
<b>BF</b>	Mit Spanbrecher
<b>NP</b>	NP-Ausführung
Keine Markierung	Standard
<b>① WSP Geometrie</b>	

NP - 
 D
N
G
A

② WSP Form		
Symbol	WSP Form	
<b>C</b>	Rhombus 80°	
<b>D</b>	Rhombus 55°	
<b>R</b>	Rund	
<b>S</b>	Vierkant	
<b>T</b>	Dreikant	
<b>V</b>	Rhombus 35°	
<b>W</b>	Sechskant	

③ Standard Freiwinkel	
Symbol	Standard Freiwinkel
<b>B</b>	5°
<b>C</b>	7°
<b>D</b>	15°
<b>E</b>	20°
<b>N</b>	0°
<b>P</b>	11°

⑤ Befestigungs- und/oder Spanbrechersymbol				
Metrisch				
Symbol	Loch	Loch Konfiguration	Spanbrecher	Abbildung
<b>W</b>	Mit Loch	Zylindrisches Loch +	Nein	
<b>T/V</b>	Mit Loch	Senkung einseitig (40–60°)	Einseitig	
<b>B</b>	Mit Loch	Zylindrisches Loch +	Nein	
<b>H</b>	Mit Loch	Senkung einseitig (70–90°)	Einseitig	
<b>A</b>	Mit Loch	Zylindrisches Loch	Nein	
<b>M</b>	Mit Loch	Zylindrisches Loch	Einseitig	
<b>N</b>	Ohne Loch	—	Nein	
<b>X</b>	—	—	—	Spezielles Design



Innenkreis- durchmesser (mm)	Symbol						
3.97		<b>02</b>		<b>04</b>	<b>03</b>	<b>03</b>	<b>06</b>
4.76		<b>L3</b>	<b>08</b>	<b>05</b>	<b>04</b>	<b>04</b>	<b>08</b>
5.56		<b>03</b>	<b>09</b>	<b>06</b>	<b>05</b>	<b>05</b>	<b>09</b>
6.35		<b>04</b>	<b>11</b>	<b>07</b>	<b>06</b>	<b>06</b>	<b>11</b>
7.94		<b>05</b>	<b>13</b>	<b>09</b>	<b>08</b>	<b>07</b>	<b>13</b>
9.525	<b>09</b>	<b>06</b>	<b>16</b>	<b>11</b>	<b>09</b>	<b>09</b>	<b>16</b>
12.70	<b>12</b>	<b>08</b>	<b>22</b>	<b>15</b>	<b>12</b>	<b>12</b>	<b>22</b>

⑥ WSP-Größe

\*Die Dicke wird von der Auflagefläche der WSP bis zur Schneidkante gemessen.

Symbol	Dicke (mm)
<b>S1</b>	1.39
<b>01</b>	1.59
<b>T0</b>	1.79
<b>02</b>	2.38
<b>T2</b>	2.78
<b>03</b>	3.18
<b>T3</b>	3.97
<b>04</b>	4.76

⑦ WSP-Stärke

Symbol	Eckenradius (mm)
<b>02</b>	0.2
<b>04</b>	0.4
<b>08</b>	0.8
<b>12</b>	1.2
<b>16</b>	1.6

⑧ WSP-Eckenkonfiguration



⑨ Anwendung (Verfassung)

Symbol	Verfassung
<b>GS</b> <b>GA</b> <b>GB</b> <b>GH</b>	Allgemeine Bearbeitung
<b>VA</b>	Für die Zerspaltung mit hoher Geschwindigkeit und hohem Vorschub
<b>FS</b> <b>FA</b> <b>FB</b>	Kontinuierlicher Schnitt
<b>TS</b> <b>TA</b> <b>TH</b>	Unterbrochener Schnitt
<b>SF</b> <b>SE</b>	Hochfeste Sinterlegierung Schnitt

⑩ Wiperausführung

<b>WS</b>	Für hochstabile Werkstücke
<b>WL</b>	Zur Verhinderung von Abdregung und Vibratonen
Keine Markierung	Ohne Wiper

⑪ Zähnezahl

<b>2</b>	2
<b>3</b>	3
<b>4</b>	4
<b>6</b>	6
Keine Markierung	1

⑫ Anstellwinkel

<b>F</b>	91°
<b>J</b>	93°
Keine Markierung	Ohne Einschränkung

Vorsicht beim Verwenden von Wiper WSP.

⑬ Drehrichtung

Abbildung	Richtung	Symbol
	Rechts	<b>R</b>
	Links	<b>L</b>
	Neutral	<b>N</b>

Siehe Seite B021 für weitere Informationen.

# EINTEILUNG VON PCBN- UND PKD-SORTEN

## EIGENSCHAFTEN

### UNBESCHICHTETE PCBN-SORTEN

Gesinterte PCBN Schneidstoffe werden durch Bindung von CBN (kubischem Bornitrid) und Keramik mit einer diamantähnlichen Härte unter sehr hohem Druck und hoher Temperatur hergestellt.

PCBN hat eine geringere Affinität zu Eisen als Diamant. Diese geringe Affinität in Kombination mit der hohen Härte bedeutet, dass gesintertes PCBN für eine ausgezeichnete Schnittleistung sorgt, insbesondere bei der Hochgeschwindigkeitsbearbeitung von gehärtetem Stahl, Gusseisen, Sinterlegierungen usw.

### BESCHICHTETE PCBN-SORTEN

Um hohe Standzeiten zu erzielen, verwendet MITSUBISHI MATERIALS ein spezielles Sinterverfahren in Kombination mit einer erhöhten Schneidkantenstabilität. Durch PCBN-Sorten mit hoher Kolkverschleißfestigkeit und einer verschleißfesten Keramikbeschichtung werden eine längere Standzeit und eine verbesserte Bearbeitungseffizienz erzielt.

### PKD-WERKSTOFFE (gesintertes Diamant)

Geeignet für die Zerspaltung von Werkstoffen wie Nichteisenmetallen und faserverstärkten Kunststoffen (FRP) einschließlich Aluminiumlegierungen. Unterstützt die Hochgeschwindigkeitszerspanung.

B  
PCBN- & PKD-  
WSP FÜR DAS DREHEN

## ■ Bearbeitungswerkstoffe für Drehsorten /Anwendungsbereich

### ● Gehärteter Stahl

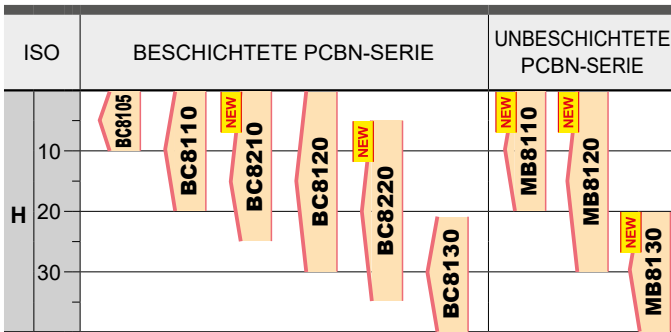

### BESCHICHTETE PCBN-SORTEN

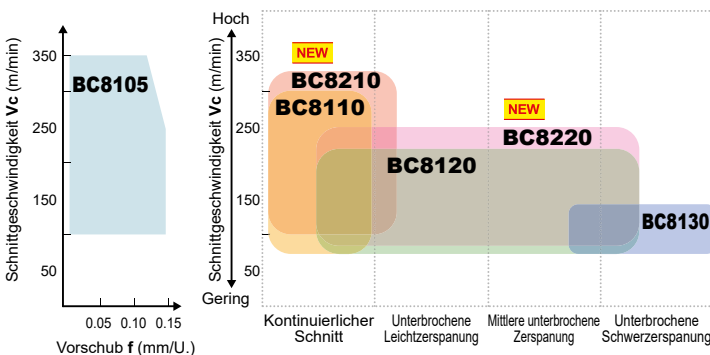

### UNBESCHICHTETE PCBN-SORTEN

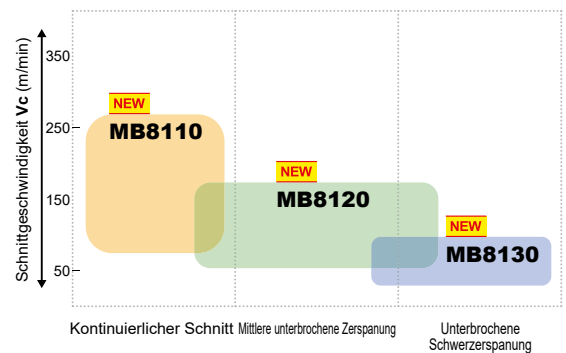

Geeignet für die Fertigbearbeitung mit einer Oberflächenrauheit von Ra 0,6 µm oder Rz 2,4 µm oder weniger.

Die beschichteten PCBN-Sorten BC8100/BC8200 und die unbeschichteten PCBN-Sorten MB8100 für die Bearbeitung von gehärtetem Stahl sind für einen breiten Anwendungsbereich erhältlich, von der Fertigbearbeitung bis zur kontinuierlichen Zerspaltung und der unterbrochenen Schwerzerspannung.

## ● Sinterlegierungen

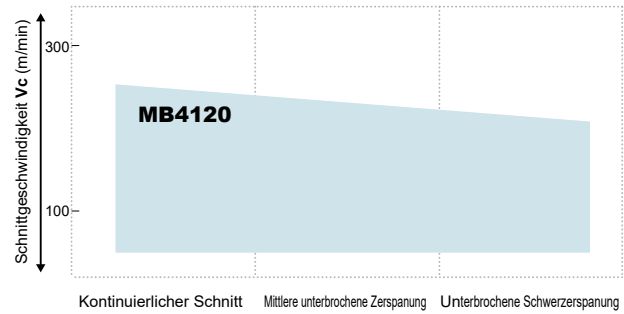
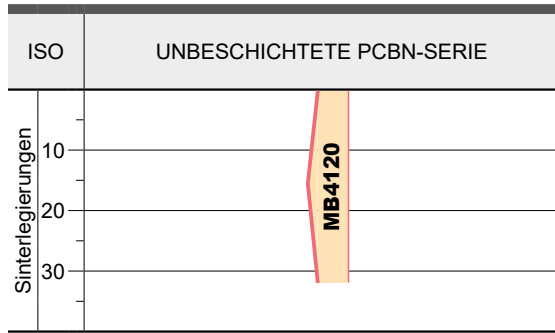

Die PCBN-Sorte „MB4120“ für die Zerspangung von Sinterlegierungen und Gusseisen ist umfassend einsetzbar: von der kontinuierlichen Zerspangung bis zur unterbrochenen Zerspangung bei der Bearbeitung von Gusseisen (z. B. Ölpumpenteile) und Sinterlegierungen (z. B. Teile von Ventilmechanismen).

## ● Gusseisen Werkstoffe

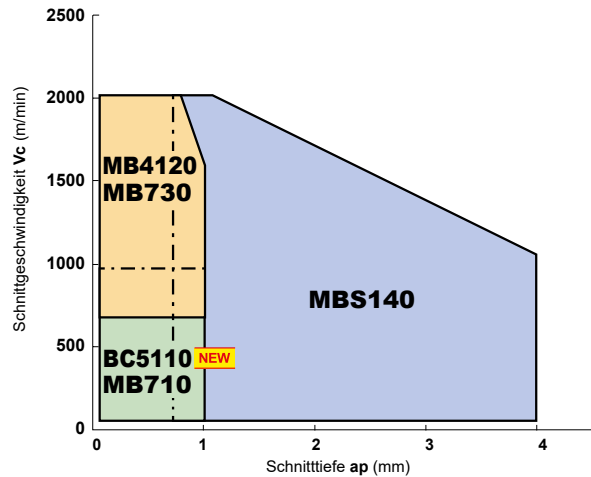
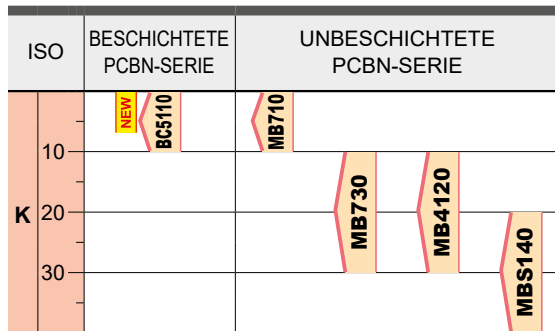

### BC5110

Zähes Substrat mit besonders harter Beschichtung bietet ausgezeichnete Abplatz- und Verschleißfestigkeit.

Verfügbare Sorten für verschiedene Anwendungen: von der allgemeinen Zerspangung bis zu großen Schnitttiefen für die hocheffiziente Bearbeitung.

## ● Aluminiumlegierung

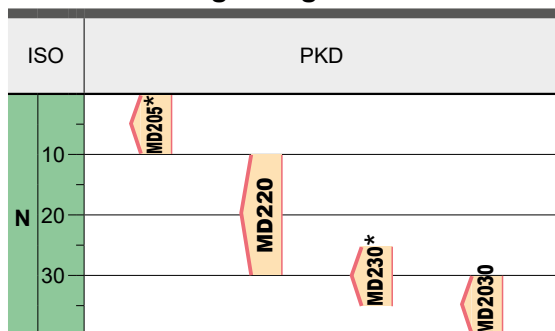

\* MD205, MD230: Nichtstandard

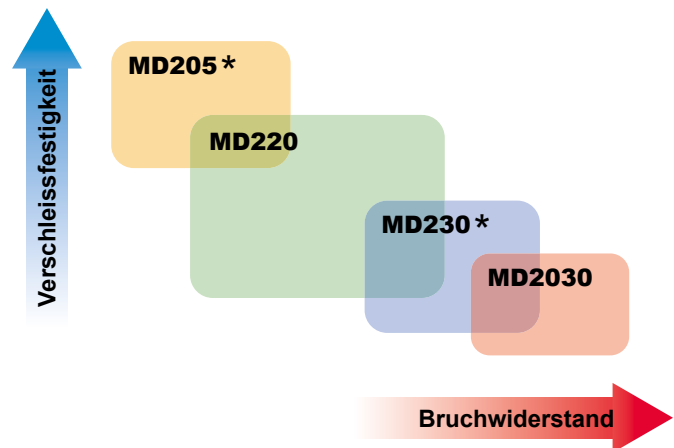

Geeignet für die Zerspangung von Werkstoffen wie Nichteisenmetallen und faserverstärkten Kunststoffen (FRP) einschließlich Aluminiumlegierungen. Unterstützt die Hochgeschwindigkeitszerspangung.

# BESCHICHTETE PCBN-SERIE

## BC8200-Serie für die Bearbeitung von gehärtetem Stahl

### EIGENSCHAFTEN

#### ■ Neu entwickelte spezielle PVD-Keramikbeschichtung

##### BC8210

NEW

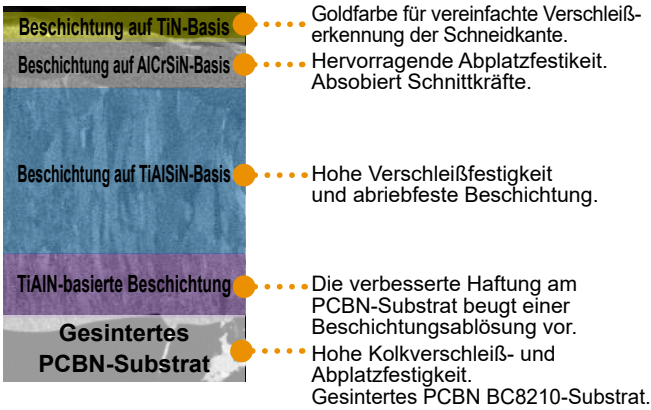

##### BC8220

NEW

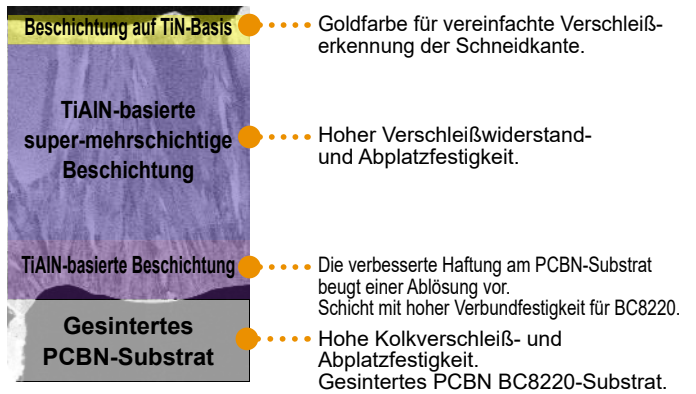

PCBN- & PKD- WSP FÜR DAS DREHEN

#### ■ Technologie mit ultra-feinkörnigem und hitzebeständigem Teilchenbinder

### Positiver Effekt der neu entwickelten hitzebeständigen Binderstruktur

Das Fortschreiten des Kolkverschleißes wird durch die Verwendung einer hitzebeständigen Binderstruktur weitgehend unterbunden. Dies verhindert Absplitterung, Kolkverschleiß und Bruch.

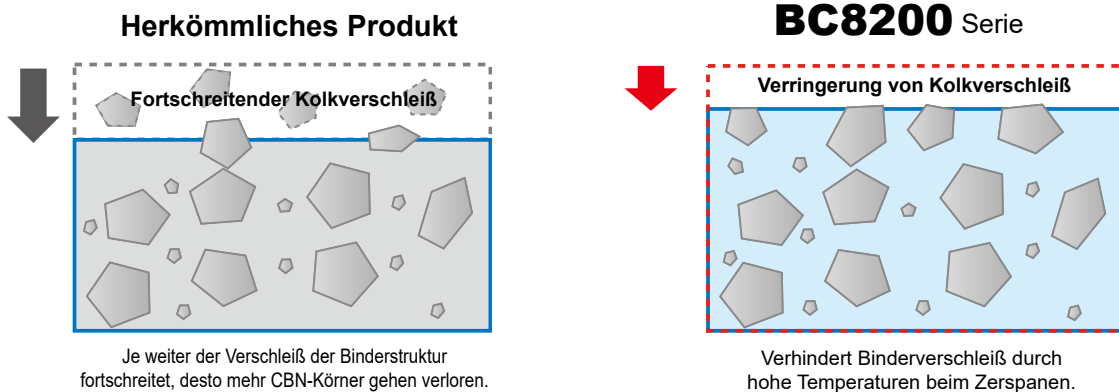

## ■ Anwendungsbereich

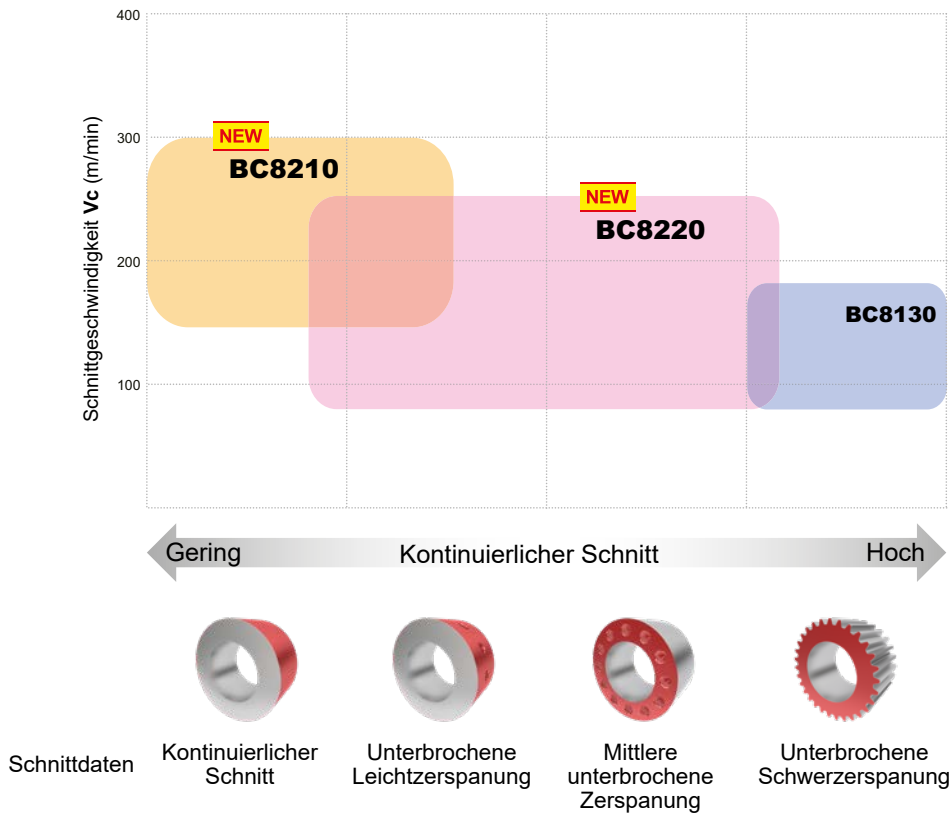

## ■ Schnittdatenempfehlung

### BC8210

Werkstoff	Bearbeitungsmethode	Schnittgeschwindigkeit $V_c$ (m/min)	Vorschub	Schnitttiefe	Schnittmodus
			$f$ (mm/U.)	$a_p$ (mm)	
Gehärtete Stähle	Kontinuierlicher Schnitt	100 - 300	$\leq 0.2$	$\leq 0.35$	Trocken, Nass
	Unterbrochene Leichtzerspanung	100 - 200	$\leq 0.2$	$\leq 0.35$	Trocken, Nass

### BC8220

Werkstoff	Bearbeitungsmethode	Schnittgeschwindigkeit $V_c$ (m/min)	Vorschub	Schnitttiefe	Schnittmodus
			$f$ (mm/U.)	$a_p$ (mm)	
Gehärtete Stähle	Kontinuierlicher Schnitt	100 - 300	$\leq 0.2$	$\leq 0.5$	Trocken, Nass
	Leichte bis mittlere unterbrochene Zerspanung	100 - 200	$\leq 0.2$	$\leq 0.3$	Trocken, Nass

# BESCHICHTETE PCBN-SERIE

## BC8200-Serie für die Bearbeitung von gehärtetem Stahl

### ■ Schnitt- und Anwendungsbeispiel

## BC8210 Für den kontinuierlichen und leicht unterbrochenen Schnitt

### Bearbeitung von DIN 20Cr4 (60 HRC): Vergleich der kontinuierlichen Bearbeitung

BC8210 verringert den Freiflächenverschleiß und ermöglicht eine hohe Oberflächengüte.

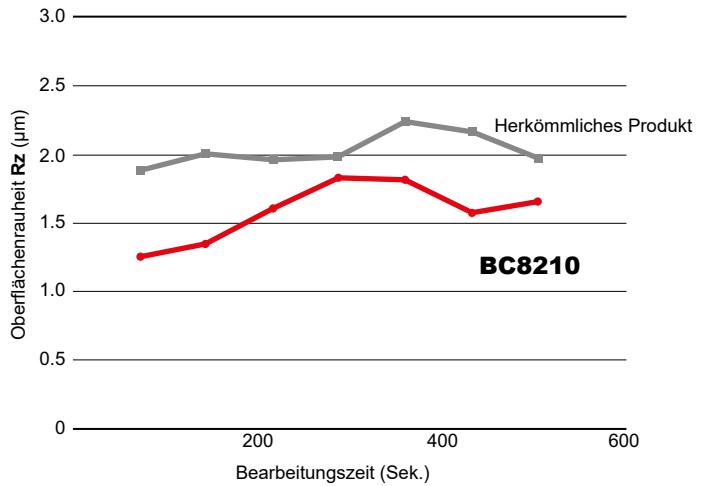
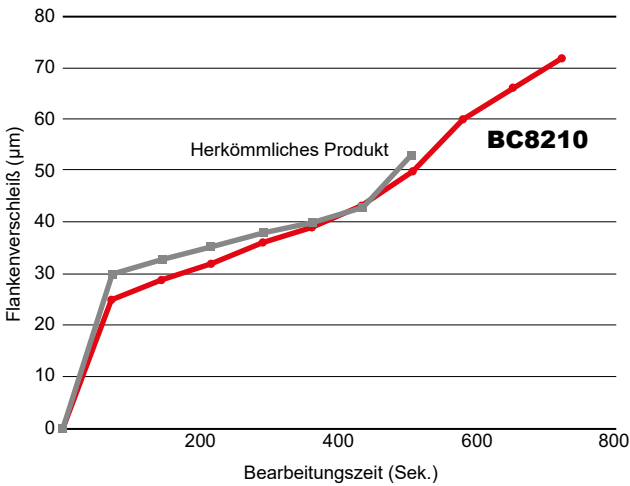

<Schnittdaten>

Werkstoff : JIS SCr420 (60 HRC)  
 WSP : NP-CNGA120408GS2  
 Schnittgeschwindigkeit : Vc=200m/min  
 Vorschub : f=0.1mm/U.  
 Schnitttiefe : ap=0.2mm  
 Schnittmodus : Trockenbearbeitung

### Bearbeitung von DIN 20Cr4 (60 HRC): Vergleich der unterbrochenen Bearbeitung

Die BC8210 bietet guten Schutz gegen Abplatzungen.

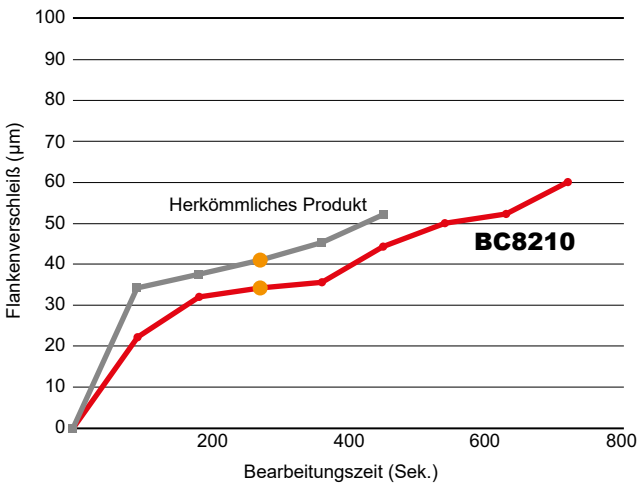

Nach 360 Sekunden Bearbeitung

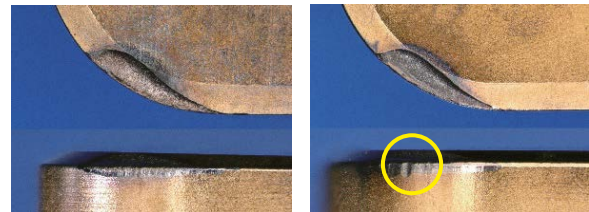

**BC8210**

Abplatzungen bei einem herkömmlichen Produkt

<Schnittdaten>

Werkstoff : JIS SCr420 (60 HRC)  
 WSP : NP-CNGA120408GS2  
 Schnittgeschwindigkeit : Vc=160m/min  
 Vorschub : f=0.1mm/U.  
 Schnitttiefe : ap=0.2mm  
 Schnittmodus : Trockenbearbeitung

# BC8220 Allgemeine Anwendungen

## Bearbeitung von DIN 20Cr4 (60 HRC): Vergleich der Bruchfestigkeit bei mittlerem unterbrochenem Schnitt

Stabiler Schnitt mit ausgezeichneter Bruchfestigkeit bei mittlerer unterbrochener Zerspanung.

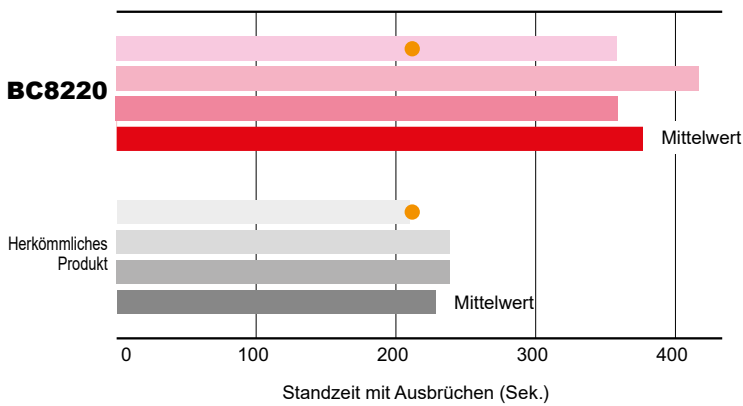

Nach 210 Sekunden Bearbeitung

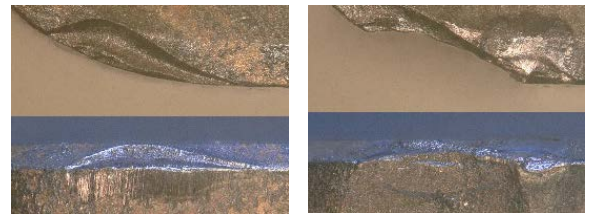

**BC8220**

Herkömmliches Produkt

<Schnittdaten>

Werkstoff : JIS SCr420 (60 HRC)  
 WSP : NP-CNGA120408VA2  
 Schnittgeschwindigkeit :  $V_c=250\text{m/min}$   
 Vorschub :  $f=0.15\text{mm/U.}$   
 Schnitttiefe :  $a_p=0.1\text{mm}$   
 Schnittmodus : Trockenbearbeitung

## Bearbeitung von DIN 20Cr4 (60 HRC): Vergleich der Bruchfestigkeit bei schwer unterbrochener Bearbeitung

Verfügt über verbesserten Absplitterungswiderstand bei schwer unterbrochener Bearbeitung.

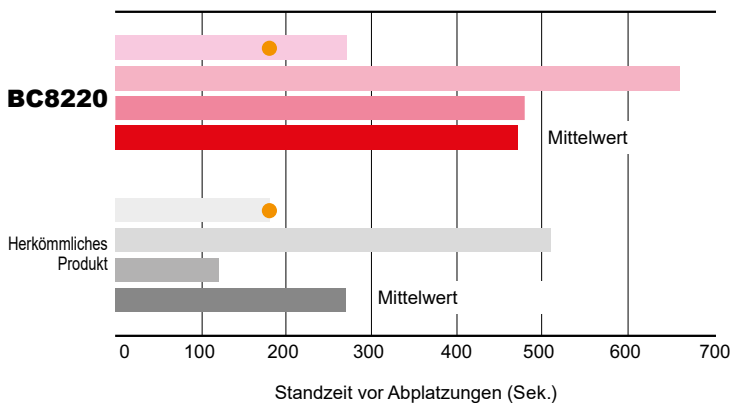

Nach 180 Sekunden Bearbeitung



**BC8220**

Absplitterungen bei einem herkömmlichen Produkt

<Schnittdaten>

Werkstoff : JIS SCr420 (60 HRC)  
 WSP : NP-CNGA120408VA2  
 Schnittgeschwindigkeit :  $V_c=200\text{m/min}$   
 Vorschub :  $f=0.05\text{mm/U.}$   
 Schnitttiefe :  $a_p=0.1\text{mm}$   
 Schnittmodus : Nassbearbeitung

B

PCBN- & PKD-  
WSP FÜR DAS DREHEN



# BESCHICHTETE PCBN-SERIE

## BC8100-Serie für die Bearbeitung von gehärtetem Stahl

### EIGENSCHAFTEN

Die beschichtete PCBN-Serie BC8100 und die unbeschichtete PCBN-Serie MB8100 für das Zerspanen von gehärtetem Stahl nutzt den PCBN-Grundwerkstoff nach der neu entwickelten und optimierten Substrat-Technologie. Der neue ultra-feinkörnige Binder verhindert plötzliche Brüche und sorgt so für eine längere Standzeit. Die Beschichtung der BC8100-Serie zeigt eine ausgezeichnete Bruch- und Verschleißfestigkeit, die sie einer speziellen, für jeden Zerspanungsanwendung geeigneten PVD-Beschichtung verdankt.

B  
PCBN- & PKD-  
WSP FÜR DAS DREHEN

### Mit einer neu entwickelten speziellen Keramik PVD-Beschichtung

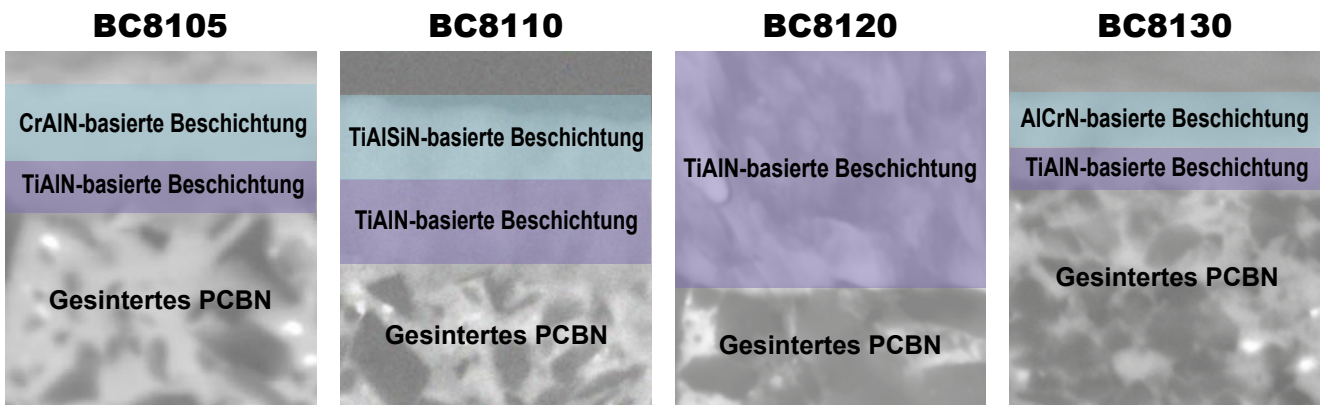

Bietet hervorragende Oberflächengüten. Abriebfestigkeit- und Schichthaftung wurden durch optimale Gleiteigenschaften und Verschleißfestigkeit verbessert.

Abspaltungen aufgrund von Aufbauschneidenbildung wird durch verbesserten Schweißwiderstand verhindert. Verbesserte Verschleißfestigkeit und Haftung am PCBN-Substrat.

Abplatzen aufgrund von Aufbauschneidenbildung wird durch verbesserten Schweißwiderstand verhindert. Verbesserte Haftung der Beschichtung am CBN-Substrat verbessert die Abriebfestigkeit. Außerdem wird die Zähigkeit des PCBN-Substrats durch die Verwendung eines neuen Binder- und Sinterverfahrens verbessert.

Abrieb durch hohe Belastungen und Abspaltung in Folge, wird durch hohe Bruchresistenz vermieden. Verbesserte Haftung am PCBN-Substrat.

\*Grafische Darstellung.

### Ultra-feinkörniger Binder verhindert plötzliche Brüche

#### ● Herkömmliches Produkt

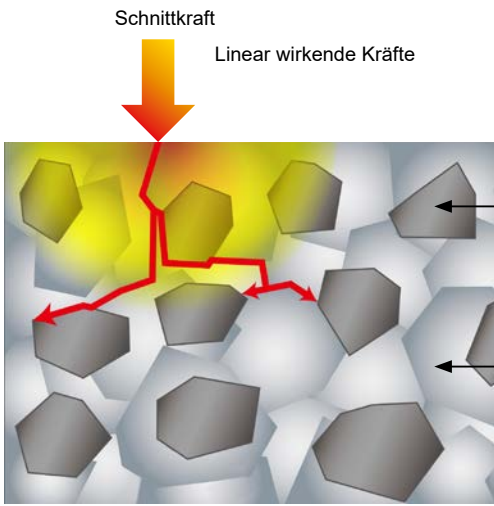

#### ● BC8100-Serie BC8200-Serie

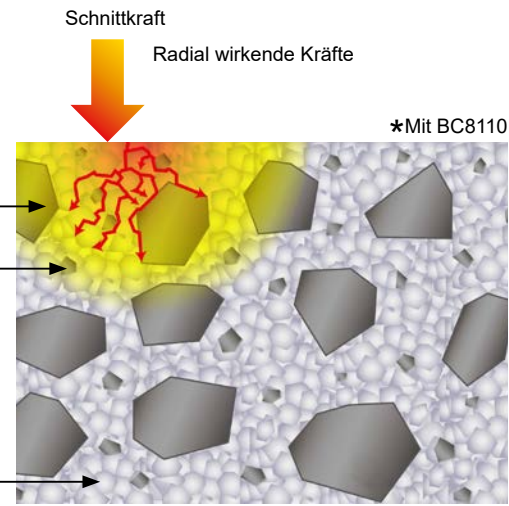

Mittlere Körnung CBN  
 Feinste Körnung CBN  
 Binder mit größeren Partikeln  
 Ultra-feinkörniger Teilchenbinder

\*Mit BC8110

Der ultra-feinkörnige Binder verhindert die Bildung linearer Risse, die zu plötzlichem Bruch führen können.



## ■ Anwendungsbereich

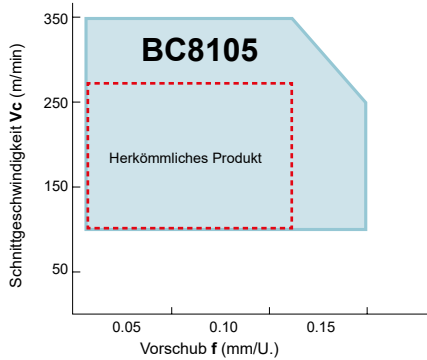

\*BC8110 wird für einen verbesserten Verschleißwiderstand empfohlen.

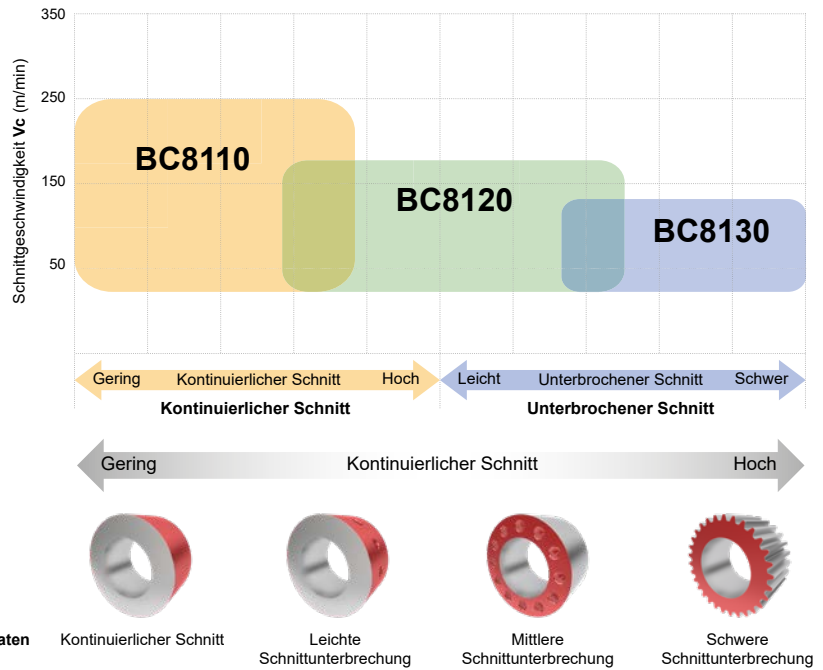

B

PCBN- & PKD-  
WSP FÜR DAS DREHEN

## ■ Schnittdatenempfehlungen

Sorte	Schnittmodus	Schnittgeschwindigkeit $V_c$ (m/min)				Vorschub $f$ (mm/U.)	Schnitttiefe $a_p$ (mm)	Schnittmodus
		50	150	250	350			
BC8105	Kontinuierlich	[Red bar from ~120 to ~280]				$\leq 0.15$	$\leq 0.2$	Trocken, Nass
BC8110	Kontinuierlich	[Red bar from ~120 to ~250]				$\leq 0.20$	$\leq 0.35$	Trocken, Nass
BC8100-Serie	Kontinuierlich	[Red bar from ~120 to ~220]				$\leq 0.3$	$\leq 0.5$	Trocken, Nass
	BC8120	Unterbrochen	[Red bar from ~100 to ~200]				$\leq 0.2$	$\leq 0.3$
BC8130	Unterbrochen	[Red bar from ~100 to ~150]				$\leq 0.20$	$\leq 0.30$	Trocken, Nass

# BESCHICHTETE PCBN-SERIE

## BC8100 Serie

### ■ Schnitt- und Anwendungsbeispiel

## BC8105 Höchste Genauigkeit

Durch den Einsatz eines PCBN-Substrats mit ausgezeichnetem Verschleißwiderstand und hervorragender Bruchfestigkeit in Kombination mit einer hochgleitenden Beschichtung wird der Verschleiß kontrolliert und eine hervorragende Oberflächenqualität erzielt.

Geeignet für die Fertigbearbeitung mit Oberflächenrauheiten Ra 0,6 µm oder Rz 2,4 µm oder weniger.

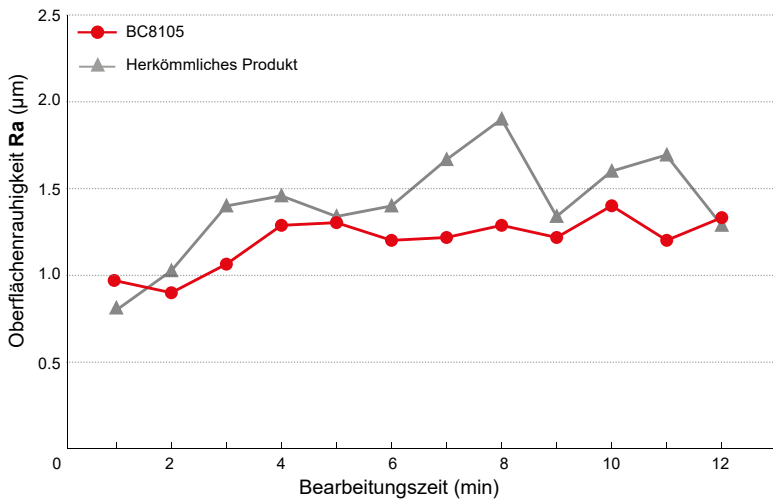

WSP	NP-CNGA120408GS2
Werkstoff	JIS SCr420 (60HRC)
Bearbeitungsmethode	Äußerer kontinuierlicher Schnitt
Schnittgeschwindigkeit Vc (m/min)	200
Vorschub f (mm/U.)	0.05
Schnitttiefe ap (mm)	0.05
Schnittmodus	Trockenbearbeitung

## BC8110 Hochgeschwindigkeitsdrehen

Durch den Einsatz eines PCBN-Substrats mit ausgezeichnetem Verschleißwiderstand und hervorragender Bruchfestigkeit in Kombination mit einer extrem harten Beschichtung wird der höchste Flankenverschleißwiderstand der gesamten BC81-Serie erzielt.

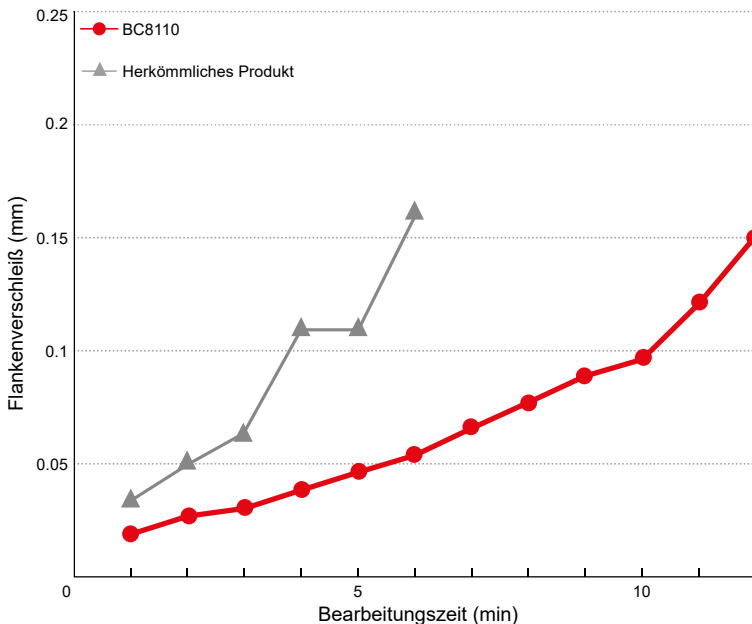

WSP	NP-CNGA120408GS2
Werkstoff	JIS SCr420 (60HRC)
Bearbeitungsmethode	Äußerer kontinuierlicher Schnitt
Schnittgeschwindigkeit Vc (m/min)	250
Vorschub f (mm/U.)	0.10
Schnitttiefe ap (mm)	0.2
Schnittmodus	Trockenbearbeitung

# BC8120 Allgemeine Anwendungen

Der Einsatz eines PCBN-Substrats mit ausgezeichneter Bruchfestigkeit und hohem Kolkverschleißwiderstand in Kombination mit einer Beschichtung mit höchstem Verschleißwiderstand sorgt für Bruchfestigkeit und Verschleißwiderstand bei gleichzeitig hervorragendem Kolkverschleißwiderstand.

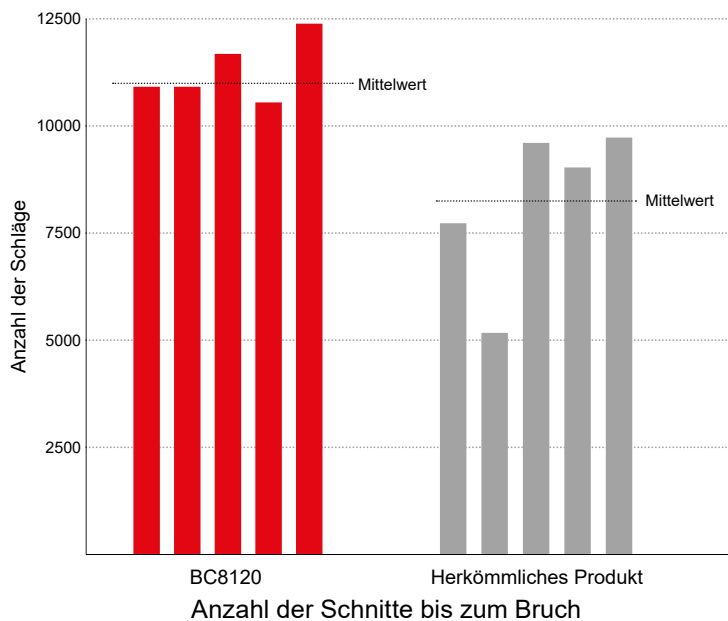

## Zustand der Schneidkante nach 8000 Schnitten

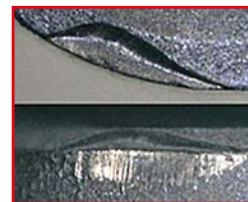

BC8120

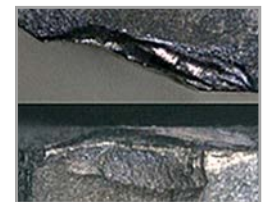

Herkömmliches Produkt

WSP	NP-CNGA120408GA2
Werkstoff	JIS SCr420 (60HRC)
Bearbeitungsmethode	Außenbearbeitung für unterbrochenen Schnitt
Schnittgeschwindigkeit $V_c$ (m/min)	250
Vorschub $f$ (mm/U.)	0.15
Schnitttiefe $a_p$ (mm)	0.1
Schnittmodus	Trockenbearbeitung

# BC8130 Schruppbearbeitung

Der Einsatz eines PCBN-Substrats mit hervorragender Schneidkantenstabilität in Kombination mit einer Beschichtung, die Härte und Schlagzähigkeit vereint, sorgt für eine überlegene Schneidkantenstabilität und Bruchfestigkeit.

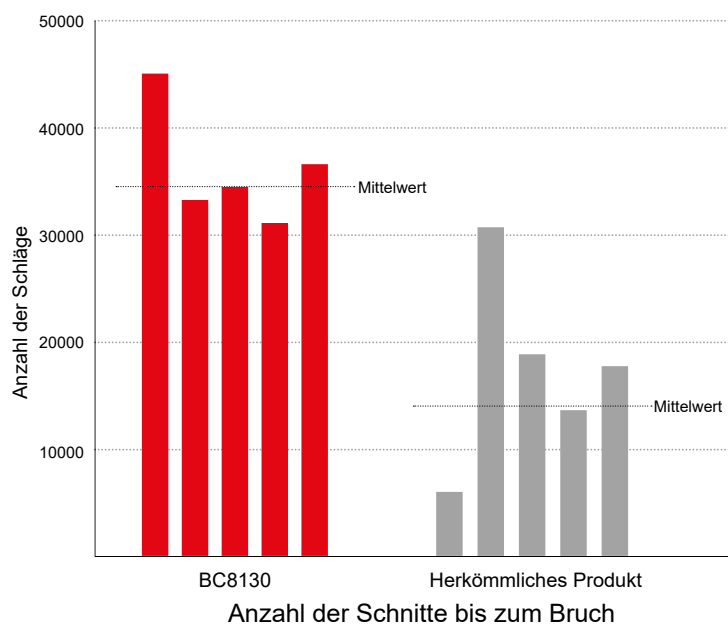

WSP	NP-CNGA120408GA2
Werkstoff	JIS SCr420 (60HRC)
Bearbeitungsmethode	Externe unterbrochene Schwerzerspannung
Schnittgeschwindigkeit $V_c$ (m/min)	250
Vorschub $f$ (mm/U.)	0.05
Schnitttiefe $a_p$ (mm)	0.1
Schnittmodus	Nassbearbeitung

# UNBESCHICHTETE PCBN-SERIE

## MB8100-Serie für die Bearbeitung von gehärtetem Stahl

### EIGENSCHAFTEN

Der PCBN-Grundwerkstoff der MB8100-Serie nutzt die optimierte Substrat-Technologie (siehe B010) der BC8100 Serie, um plötzliche Beschädigungen bei der Zerspanung zu verhindern und eine lange Standzeit zu erzielen.

Die MB8100-Serie umfasst MB8110 für die kontinuierliche Zerspanung, MB8120 für die allgemeine Zerspanung und MB8130 für die unterbrochene Zerspanung und kann in einem umfassenden Bereich von Zerspanungsanwendungen eingesetzt werden.

B

PCBN- & PKD-  
WSP FÜR DAS DREHEN

### Anwendungsbereich

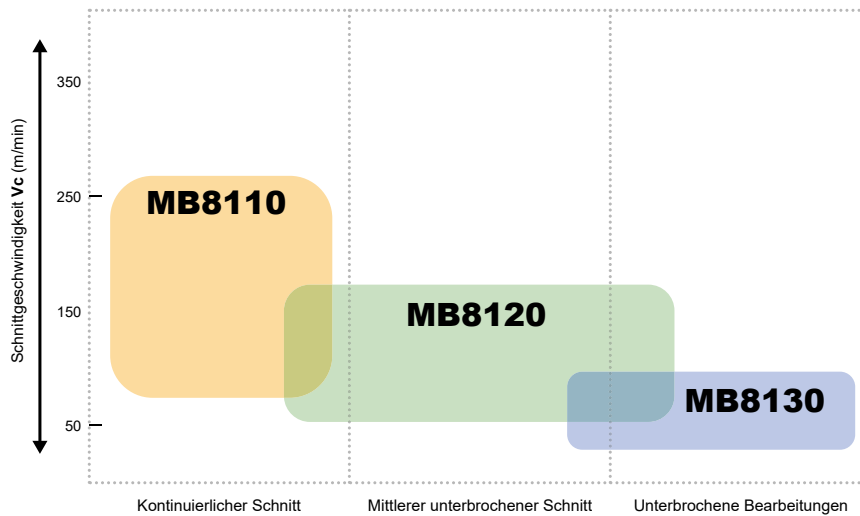

### Schnittdatenempfehlungen

Sorte	Schnittmodus	Schnittgeschwindigkeit $V_c$ (m/min)					Vorschub $f$ (mm/U.)	Schnitttiefe $a_p$ (mm)	Schnittmodus	
		50	100	150	200	250				300
MB8100-Serie	MB8110	Kontinuierlich	[100 bis 250]					$\leq 0.2$	$\leq 0.3$	Trocken, Nass
	MB8120	Kontinuierlich	[100 bis 200]					$\leq 0.2$	$\leq 0.5$	Trocken, Nass
		Unterbrochen	[100 bis 150]					$\leq 0.2$	$\leq 0.3$	Trocken, Nass
MB8130	Unterbrochen	[100 bis 150]					$\leq 0.2$	$\leq 0.3$	Trocken, Nass	

## ■ Anwendungsbeispiele

# MB8110 Kontinuierlicher Schnitt

### Standzeit (Flankenverschleiß)

WSP	NP-CNGA120408GA2
Werkstoff	JIS SCr420 (60HRC)
Bearbeitungsmethode	Äußerer kontinuierlicher Schnitt
Schnittgeschwindigkeit Vc (m/min)	250
Vorschub f (mm/U.)	0.1
Schnitttiefe ap (mm)	0.2
Schnittmodus	Trockenbearbeitung

### Schneidkante nach 180 Sekunden Einsatz

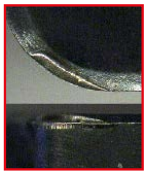

MB8110



Herkömmliches Produkt

Hoher Verschleiß

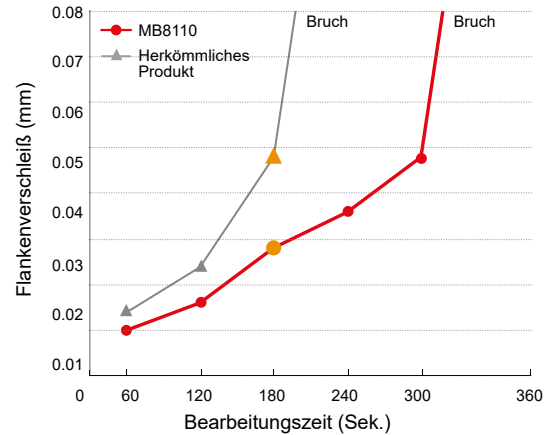

# MB8120 Allgemeine Anwendungen

### Versuch im unterbrochenen Schnitt

WSP	NP-CNGA120408GA2
Werkstoff	JIS SCr420 (60HRC)
Bearbeitungsmethode	Äußerer kontinuierlicher Schnitt
Schnittgeschwindigkeit Vc (m/min)	250
Vorschub f (mm/U.)	0.15
Schnitttiefe ap (mm)	0.1
Schnittmodus	Trockenbearbeitung

17000 Schnitte



MB8120

11000 Schnitte

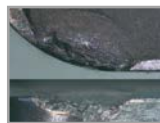

Herkömmliches Produkt

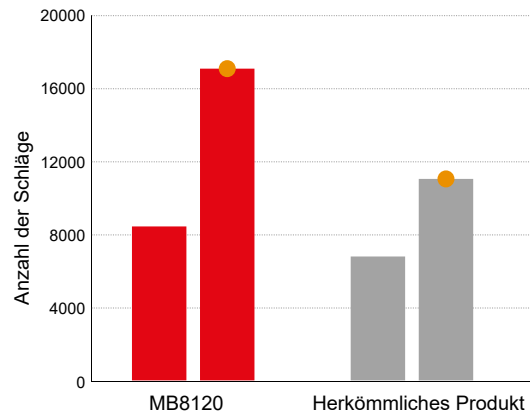

# MB8130 Unterbrochener Schnitt

### Versuch im unterbrochenen Schnitt

WSP	NP-CNGA120408GA2
Werkstoff	JIS SCr420 (60HRC)
Bearbeitungsmethode	Externe unterbrochene Schwerzerspannung
Schnittgeschwindigkeit Vc (m/min)	150
Vorschub f (mm/U.)	0.05
Schnitttiefe ap (mm)	0.1
Schnittmodus	Nassbearbeitung

77000 Schnitte



MB8130

54000 Schnitte



Herkömmliches Produkt

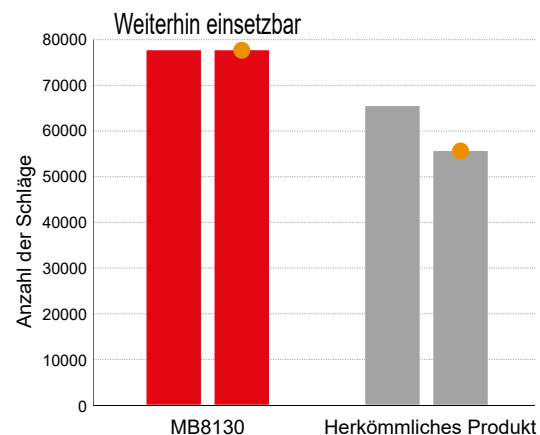

B

PCBN- & PKD-  
WSP FÜR DAS DREHEN

# PCBN

## PCBN-Sorte für Sinterlegierungen • Bearbeitung von Gusseisen MB4120/BC5110/MB710/MB730/MBS140

### ■ Anwendungsbereich

#### ● PCBN-Sorte für Sinterlegierungen

#### ● Bearbeitung von Gusseisen

B  
PCBN- & PKD-  
WSP FÜR DAS DREHEN

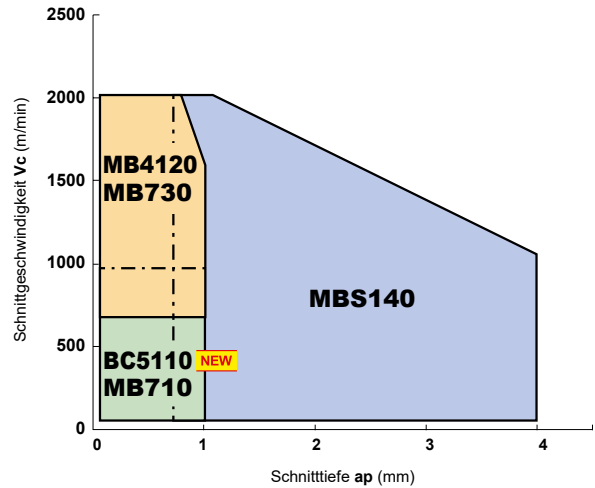
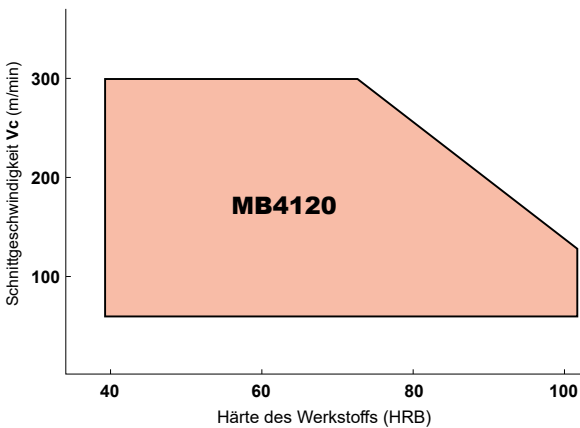

### ■ Schnittdatenempfehlungen

#### ● PCBN-Sorte für Sinterlegierungen

Werkstoff	Anwendungsbereich	Sorte	Schnittgeschwindigkeit Vc (m/min)					Vorschub f (mm/U.)	Schnitttiefe ap (mm)	Schnittmodus
			100	150	200	250	300			
Allgemeine Sinterlegierung	Allgemeine Bearbeitung	<b>MB4120</b>	[Bar chart showing Vc range from ~150 to 300]					≤0.2	≤0.3	Trocken, Nass
Hochdichte Sinterlegierung	Allgemeine Bearbeitung	<b>MB4120</b>	[Bar chart showing Vc range from ~100 to 200]					≤0.2	≤0.3	Trocken, Nass
Sinterlegierungon	Allgemeine Bearbeitung	<b>MB4120</b>	[Bar chart showing Vc range from ~100 to 150]					≤0.2	≤0.3	Trocken, Nass

#### ● Bearbeitung von Gusseisen

Werkstoff	Anwendungsbereich	Sorte	Schnittgeschwindigkeit Vc (m/min)								Vorschub f (mm/U.)	Schnitttiefe ap (mm)	Schnittmodus
			100	250	500	600	750	1000	1250	1500			
Grauguss GG25, GG30	Allgemeine Bearbeitung	<b>MB4120</b>	[Bar chart showing Vc range from ~750 to 1250]								≤0.4	≤0.5	Trocken, Nass
	Allgemeine Bearbeitung	<b>MB730</b>	[Bar chart showing Vc range from ~1000 to 1250]								≤0.5	≤1.0	Trocken, Nass
	Allgemeine Bearbeitung	<b>MB710</b>	[Bar chart showing Vc range from ~500 to 1000]								≤0.5	≤1.0	Trocken, Nass
	Geringe Schnittgeschwindigkeiten	<b>BC5110</b> <small>NEW</small>	[Bar chart showing Vc range from ~250 to 600]								≤0.5	≤0.5	Trocken, Nass
	Schwerzerspannung	<b>MBS140</b>	[Bar chart showing Vc range from ~500 to 1500]								≤0.5	≤5	Trocken, Nass

# UNBESCHICHTETE PCBN-SORTEN

## PCBN-Sorte für Sinterlegierungen • Bearbeitung von Gusseisen

# MB4120

● Erste Empfehlung für einen umfassenden Anwendungsbereich; von der kontinuierlichen bis zur unterbrochenen Zerspangung von Sinterlegierungen und Gusseisen.

## EIGENSCHAFTEN

### Hoher Bruchwiderstand

Durch feine CBN-Partikel wird die Zähigkeit der Schneidkante verbessert. Dank der hohen Bruchfestigkeit wird eine beständige Leistung, auch bei der unterbrochenen Bearbeitung, sichergestellt.

### Hohe Adhäsionsstärke der feinen CBN-Partikel

Durch die Optimierung der Sinterbedingungen wird die Adhäsion zwischen den feinen CBN-Partikeln gestärkt. Dadurch werden die Bruchfestigkeit und der Verschleißwiderstand verbessert.

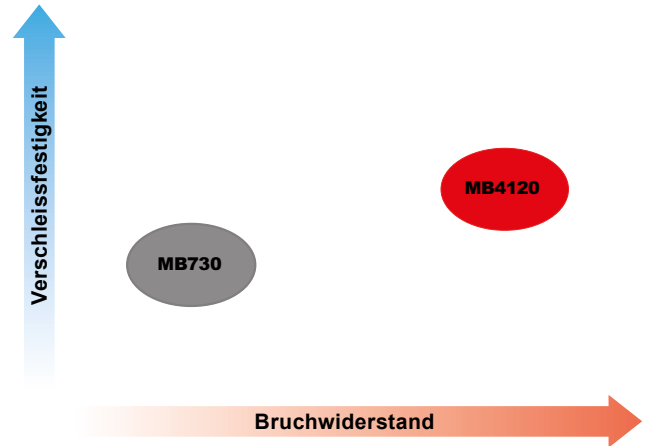

**B**

PCBN- & PKD-  
WSP FÜR DAS DREHEN

## ■ Anwendungsbeispiele

Vergleich der Bruchfestigkeit bei unterbrochenem Plandrehen einer hochfesten Sinterlegierung

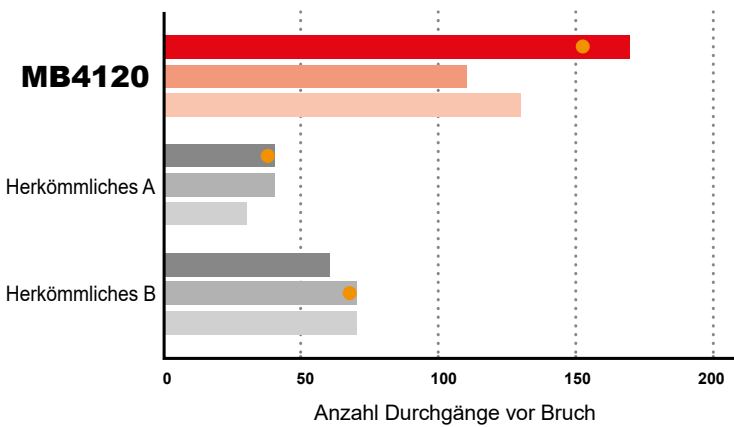

<Schnittdaten>

Werkstück : Hochfeste Sinterlegierung  
 WSP : NP-TNGA160408SE3  
 Schnittgeschwindigkeit :  $V_c=150\text{m/min}$   
 Vorschub :  $f=0.15\text{mm/U.}$   
 Schnitttiefe :  $a_p=0.1\text{mm}$   
 Schnittmodus : Nassbearbeitung

Vergleich bei kontinuierlicher Bearbeitung von DIN GG25

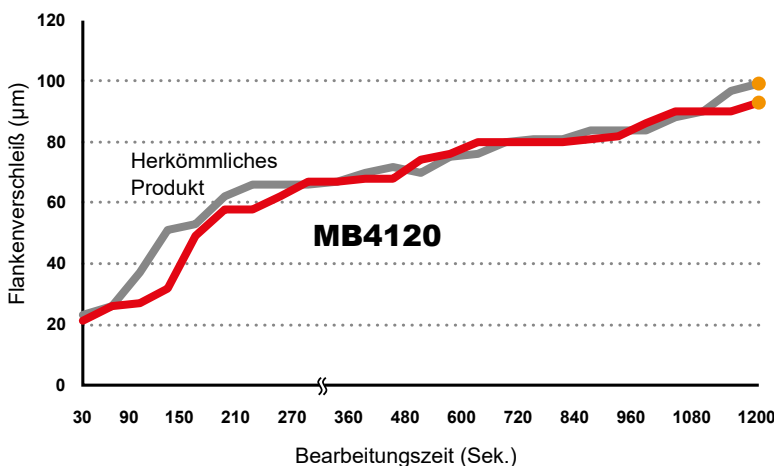

**MB4120** 1200 Sek.      Herkömmliches Produkt 1200 Sek.

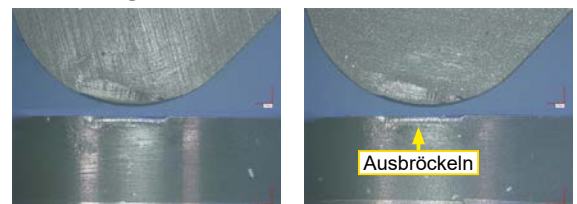

<Schnittdaten>

Werkstück : DIN GG25 (Perlit)  
 WSP : NP-TNGA160408SF3  
 Schnittgeschwindigkeit :  $V_c=800\text{m/min}$   
 Vorschub :  $f=0.1\text{mm/U.}$   
 Schnitttiefe :  $a_p=0.2\text{mm}$   
 Schnittmodus : Trockenbearbeitung



# BESCHICHTETE PCBN-SERIE

## Bearbeitung von Gusseisen BC5110

### EIGENSCHAFTEN

BC5110 nutzt ein zähes Substrat mit besonders harter Beschichtung und bietet so einen überlegenen Schutz vor Absplitterungen und Verschleiß.

B

#### Hervorragende Abplatzfestigkeit

Im Vergleich zu herkömmlichen Sorten verbessert sich durch das feinkörnige Substrat mit hohem CBN-Gehalt die Abplatzfestigkeit ganz erheblich, was die Stabilität erhöht und die Standzeit verlängert.

#### Beschichtung für hohen Verschleißwiderstand

Die harte Keramikbeschichtung sorgt für hervorragende Oberflächengüte und einen hohen Verschleiß- und Kerbwiderstand bei kontinuierlicher Zerspanung.

Darüber hinaus wird ein Absplintern oder Abschälen der Beschichtung dank des festeren Verbunds mit dem PCBN-Substrat verhindert.

Verschleißfestigkeit



Abplatzfestigkeit

### ■ Bearbeitung von GG25: Vergleich von Verschleißfestigkeit und Oberflächengüte.

Das harte Substrat und die verschleißfeste Beschichtung bei der BC5110 sorgen für eine hervorragende Oberflächengüte im Vergleich zu herkömmlichen unbeschichteten Sorten.

#### Vergleich von Freiflächenverschleiß

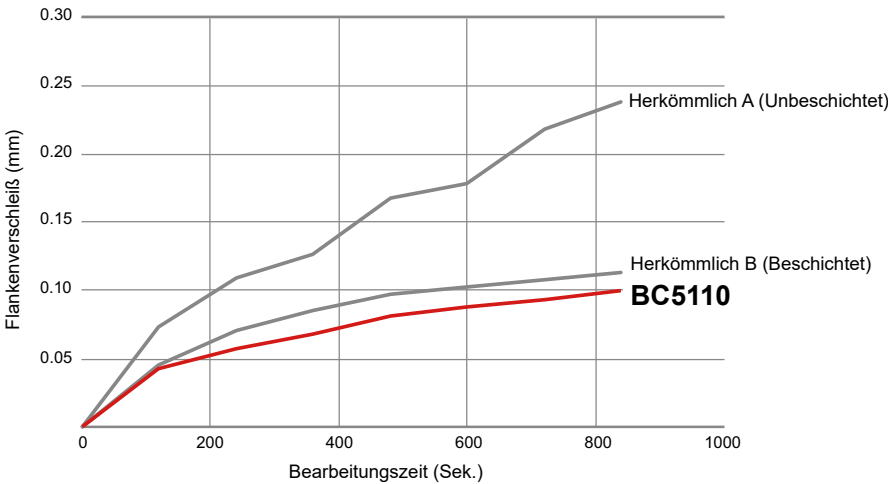

#### Vergleich der Oberflächengüte

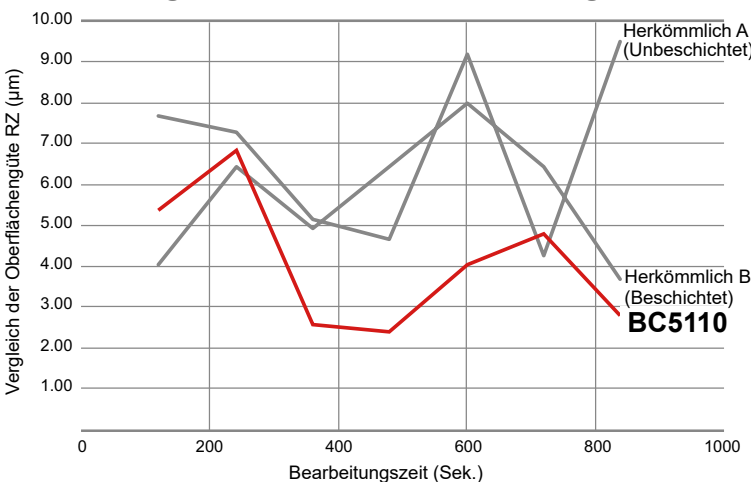

BC5110

900 sec Herkömmliches Produkt 900 sec

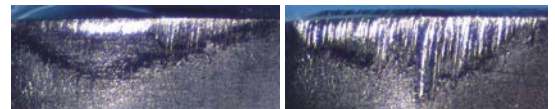

<Schnittdaten>

Werkstoff : GG25  
 WSP : CNGA120408  
 Bearbeitungsmethode : Äußerer kontinuierlicher Schnitt  
 Schnittgeschwindigkeit :  $V_c = 300$  m/min  
 Vorschub :  $f_r = 0.1$  mm/U.  
 Schnitttiefe :  $a_p = 0.2$  mm  
 Schnittmodus : Trockenbearbeitung

# VOLL-PCBN

## Gusseisen-Bearbeitung MBS140

### EIGENSCHAFTEN

#### Für die Hochgeschwindigkeitsbearbeitung mit großen Schnitttiefen

Da es sich bei den WSP um Voll-PCBN-Körper handelt, sind den Schnitttiefen anders als bei PCBN-Löt WSP keine Grenzen gesetzt, was die Bearbeitung mit großen Schnitttiefen ermöglicht. Bei der Schruppzerspanung von Gusseisen kann die für PCBN-Werkzeuge charakteristische hocheffiziente Hochgeschwindigkeitsbearbeitung erzielt werden.

#### Kombiniert Verschleißwiderstand und Bruchfestigkeit

Der Einsatz von Feinstkorn-CBN in Kombination mit einem neu entwickelten speziellen Binder sorgt für einen hohen Verschleißwiderstand. Der Einsatz der hocheffizienten Original-Sinter-Technologie von Mitsubishi Materials sorgt für eine hohe Bruchfestigkeit und ist ideal für die Bearbeitung mit hohen Schnitttiefen geeignet.

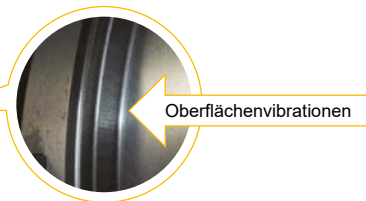
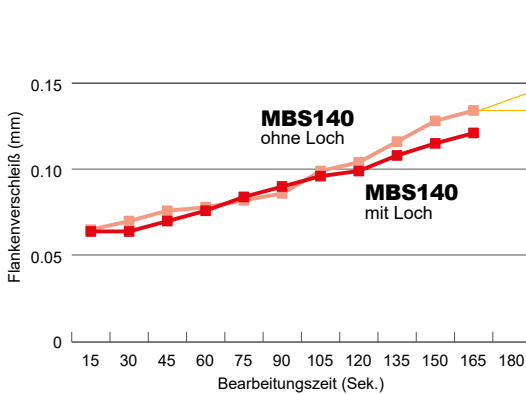

<Schnittdaten>  
 Werkstück : GG25  
 WSP : CNGA120408/CNGN120408  
 Halter : Doppel Klemm Halter  
 Schnittgeschwindigkeit :  $V_c=400$  m/min  
 Vorschub :  $f=0.05$  mm/U.  
 Schnitttiefe :  $a_p=5.0$  mm  
 Schnittmodus : Trockenbearbeitung

#### Zusätzliche WSP-Serien mit Bohrungen Vergleich der Schnitttiefe 5-mm-Plandrehen

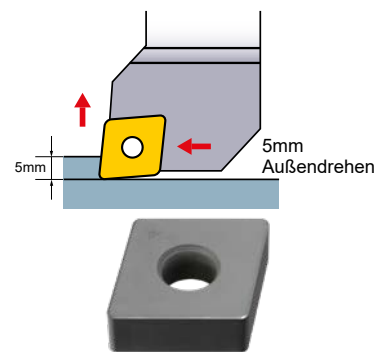

B  
PCBN- & PKD-  
WSP FÜR DAS DREHEN

# PCBN

## FÜR ZYLINDERLAUFBUCHSE MB5015

\*Herstellung nur auf Anfrage.

### EIGENSCHAFTEN

MB5015 ist eine exklusive Sorte für das Innendrehen von Schleuderguss-Zylinderlaufbuchsen beim Vorschlichten und Schlichten mit hohem Verschleißwiderstand.

#### ■ Schnittdatenempfehlung

Werkstoff	Schnittmodus	Schnittgeschwindigkeit $V_c$ (m/min)				Vorschub $f$ (mm/U.)	Schnitttiefe $a_p$ (mm)	Schnittmodus
		100	500	1000	1500			
Schleuderguss	Guss	----- ----- ----- -----				-0.3(Schlichten) -0.8(Semi-Schlichten)	-0.05(Schlichten) -0.2(Semi-Schlichten)	Nassbearbeitung

#### ■ Schnittleistung

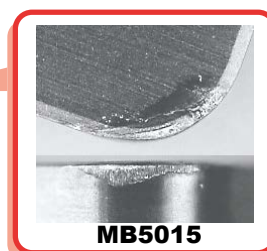
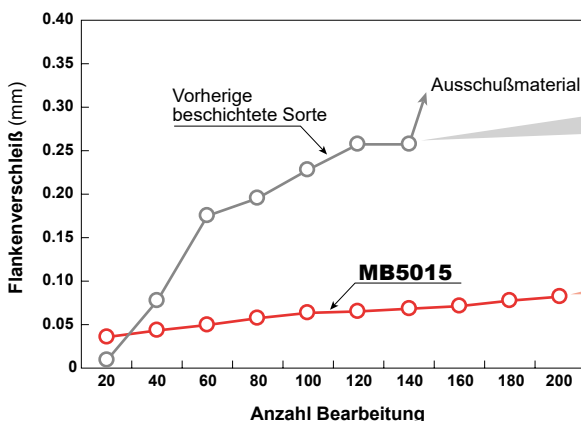

<Schnittdaten>  
 Werkstück : GG25  
 (Schleuderguss)  $\phi 63.0$   
 Schnittgeschwindigkeit :  $V_c=800$ m/min  
 Vorschub :  $f=0.35$ mm/U.  
 Schnitttiefe :  $a_p=0.03$ mm  
 Arbeit : Schleuderguss Zylinderlaufbuchse  
 Bohrtiefe : 100mm

## PCBN

- Für das Hartdrehen von gehärteten Stählen, Sinterlegierungen und Gusseisen mit hohen Schnittgeschwindigkeiten.
- Schleifen kann durch Zerspanen ersetzt werden.



### ● Wärmebehandelter Stahl

Werkstoff	Typ	Schnittmodus	Empfohlene Sorte	Schnittdatenempfehlungen			
				Schnittgeschw. Vc (m/min)	Vorschub f (mm/U.)	Schnitttiefe ap (mm)	Schnittmodus
Baustahl Niedrig gekohlter Stahl Hochlegierter Stahl	Beschichtet	Schlichtzerspanung bei hohen Geschwindigkeiten	<b>BC8105</b>	250 (100–350)	≤0.15	≤0.2	Trocken, Nass
		Kontinuierlicher Schnitt	<b>NEW BC8210</b> <b>BC8110</b>	200 (100–300)	≤0.2	≤0.35	Trocken, Nass
			<b>NEW BC8220</b> <b>BC8120</b>	200 (100–230)	≤0.3	≤0.8	Trocken, Nass
		Mittlerer unterbrochener Schnitt	<b>NEW BC8220</b> <b>BC8120</b>	150 (60–200)	≤0.2	≤0.3	Trocken, Nass
	Unterbrochener Schnitt	<b>BC8130</b>	120 (60–150)	≤0.2	≤0.3	Trocken, Nass	
	Unbeschichtet	Kontinuierlicher Schnitt	<b>NEW MB8110</b>	200 (100–250)	≤0.2	≤0.3	Trocken, Nass
			<b>NEW MB8120</b>	150 (80–220)	≤0.2	≤0.5	Trocken, Nass
		Mittlerer unterbrochener Schnitt	<b>NEW MB8120</b>	130 (85–180)	≤0.2	≤0.3	Trocken, Nass
Unterbrochener Schnitt		<b>NEW MB8130</b>	100 (60–150)	≤0.2	≤0.3	Trocken, Nass	

B

PCBN- & PKD-  
WSP FÜR DAS DREHEN

### ● Gusseisen Werkstoffe

Werkstoff	Werkstoff Struktur	Schnittgeschw. Vc (m/min)					Vorschub f (mm/U.)	Schnitttiefe ap (mm)	Schnittmodus
		250	500	750	1000	1250			
Grauguss	<b>GG25</b> Ferritisch + Perlitisch	<b>MBS140</b>					-0.5	-1.0 MBS140/BC5110 -5.0	Trocken, Nass
	<b>GG30</b> Perlitisch	<b>NEW BC5110</b>	<b>MB710</b>	<b>MB730</b>					
Legierter Grauguss	Perlitisch			<b>MB4120</b>		-0.4	-0.5	Trocken, Nass	
Duktiler Guss	<b>GGG40</b> Ferritisch	<b>MB710</b>					-0.4	-0.5	Trocken, Nass
	<b>GGG70</b> Ferritisch + Perlitisch Perlitisch	<b>MB730</b>							

### ● Sinterlegierungen

Werkstoff	Empfohlene Sorte	Schnittdatenempfehlungen		
		Schnittgeschw. Vc (m/min)	Vorschub f (mm/U.)	Schnitttiefe ap (mm)
Allgemeine Sinterlegierung	<b>MB4120</b>	180 (80–300)	-0.2	-0.3
Hochdichte Sinterlegierung	<b>MB4120</b>	150 (80–230)	-0.2	-0.3
Sinterlegierungon	<b>MB4120</b>	130 (80–180)	-0.2	-0.3

### ● Ventilsitze

Anzahl an Hartpartikeln	Keine oder kleine	→ Große		
Werkstück-Härte (HV)	150	250	300	350
Tauchschnitte	<b>MB4120</b>	<b>MB825</b>	<b>MB835</b>	
Längsschnitte	<b>MB4120</b>	<b>MB710</b>	<b>MB825</b>	

### ● Rolle

Werkstoff	Sorte	Schnittdatenempfehlungen		
		Schnittgeschw. Vc (m/min)	Vorschub f (mm/U.)	Schnitttiefe ap (mm)
Duktiler Guss GTW Kokillenguss	<b>MB710</b>	80 (30–130)	0.3 (0.1–0.5)	0.2–3.0
HSS	<b>MB730</b>	50 (20–70)	0.25 (0.1–0.4)	0.1–3.0
Hartmetall	<b>MB730, MBS140</b>	20 (10–30)	-0.2	-0.2

### ● Hitzebeständiger Stahl

Werkstoff	Sorte	Schnittdatenempfehlungen		
		Schnittgeschw. Vc (m/min)	Vorschub f (mm/U.)	Schnitttiefe ap (mm)
Ni hitzebeständige Basislegierungen (z.B.: Inconel)	<b>MB730</b>	120 (100–150)	-0.2	-0.5
Co hitzebeständige Basislegierungen (z.B.: Stellite)	<b>MB730</b>	70 (50–100)	-0.2	-0.5

# VERFASUNG

## ■ Schneidkantenpräparation für die Bearbeitung von gehärtetem Stahl

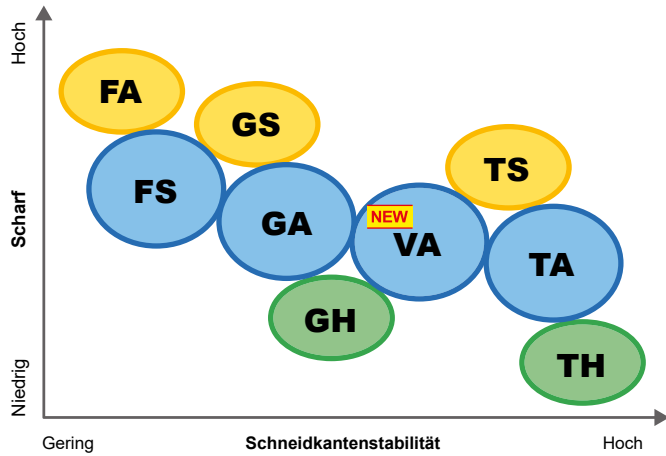

- **Allgemeine Bearbeitung**  
 GA -Verfassung : Allgemeine Bearbeitung  
 GS -Verfassung : Vibrationskontrolle und Gratkontrolle  
 GH -Verfassung : Für Schnitttiefen von 0,15 oder mehr
- **Allgemeine Bearbeitung (Für Bruchfestigkeit)**  
 VA -Verfassung : Hohe Geschwindigkeiten und hoher Vorschub
- **Kontinuierlicher Schnitt, Stabile Bearbeitung**  
 FS -Verfassung : Allgemeine Bearbeitung  
 FA -Verfassung : Weniger Probleme mit scharfkantigen Spänen im Vergleich zu FS
- **Mittlere und schwer unterbrochene Schnitte, instabile Schnitte**  
 TA -Verfassung : Allgemeine Bearbeitung  
 TS -Verfassung : Vibrationskontrolle und Gratkontrolle  
 TH -Verfassung : Für Schnitttiefen von 0,15 oder mehr

B  
PCBN- & PKD-  
WSP FÜR DAS DREHEN

## ■ Schneidkantenverfassung für die Bearbeitung von Sinterlegierungen

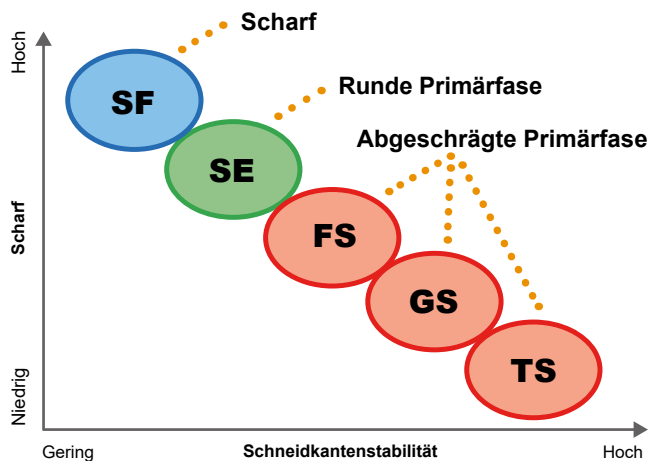

- **Kontinuierlicher Schnitt, Stabile Bearbeitung**  
 FS -Verfassung : Kontinuierlicher Schnitt, Allgemeine Bearbeitung
- **Mittlere und schwer unterbrochene Schnitte, instabile Schnitte**  
 GS, TS -Verfassung : Wenn plötzliche Ausbrüche an der Schneidkante während des unterbrochenen Schnitts auftreten
- **Hochpräzise Schnitte**  
 SF -Verfassung : Verbesserte Oberflächengüte  
 SE -Verfassung : Spankontrolle

# NP-CNGA120408-**G** **A** 2

Hauptanwendung

Eckenverfassung

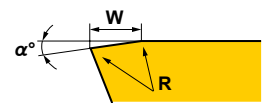

(mm)

	A			S			H			F			E		
	Teilprofil			Vibrationskontrolle und Gratkontrolle			Hohe effizienz			Hohe präzision			Spankontrolle		
	α	W	R	α	W	R	α	W	R	α	W	R	α	W	R
<b>F</b> Kontinuierlicher Schnitt	15°	0.1	0	15°	0.1	0.015	—	—	—	—	—	—	—	—	—
<b>G</b> Allgemeine Bearbeitung	25°	0.13	0.03	25°	0.13	0.015	25°	0.27	0.03	—	—	—	—	—	—
<b>V</b> Für die Zerspanung mit hoher Geschwindigkeit und hohem Vorschub	30°	0.13	0.04	—	—	—	—	—	—	—	—	—	—	—	—
<b>T</b> Unterbrochener Schnitt	35°	0.13	0.03	35°	0.13	0.015	35°	0.27	0.03	—	—	—	—	—	—
<b>S</b> Hochpräzise Schnitte	—	—	—	—	—	—	—	—	—	0	0	0	0	0	0.01

Herkömmliche Verfassungen  
 F -Verfassung : 0.1mm×15°+R0  
 G -Verfassung : 0.13mm×25°+R0.03  
 T -Verfassung : 0.13mm×35°+R0.03

# PCBN-WSP MIT SPANBRECHER

## EIGENSCHAFTEN

### Spanbrechergeometrie für hervorragende Spankontrolle

Der radiale Spanbrecher sorgt für eine Optimierung von Schnittpunkt und Spanbrecherposition.

Für eine wirksame Spanabfuhr selbst bei der Kopierbearbeitung. Die Lösung gegen Wirrspäne und Oberflächenbeschädigung durch mangelhafte Spankontrolle.

### Beschichtetes PCBN mit hoher Standzeit

Die Kombination aus Beschichtungsorte und Spanbrecher sorgt für höchste Effizienz und eine lange Werkzeugstandzeit bei einer Vielzahl von Anwendungen.

B

PCBN- & PKD-  
WSP FÜR DAS DREHEN

## Spanbrecher

### ● BM-Spanbrecher (Hohe Schnitttiefen)

Ideal für die Bearbeitung von aufgekohlten Schichten mit großen Schnitttiefen.

Empfohlen unter  $a_p = 0,6 \text{ mm}$

\*Lieferbar in der Sorte BC8120 & BC8220 .

### ● BF-Spanbrecher (Geringe Schnitttiefe)

Geeignet für die Spanabfuhr beim Schneiden mit geringen Tiefen und geringem Vorschub.

Empfohlen unter  $a_p = 0,3 \text{ mm}$

\*Lieferbar in der Sorte BC8120 & BC8220 .



BM-Spanbrecher

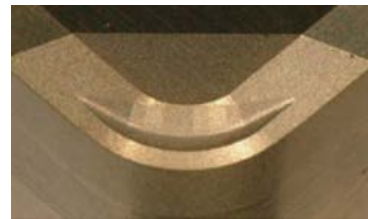

BF-Spanbrecher

## Anwendungsbereich

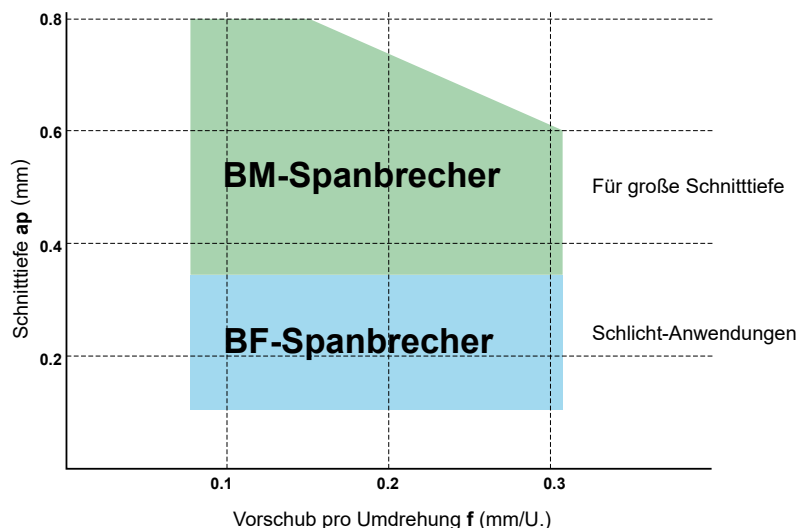

## ■ Anwendungsbeispiele

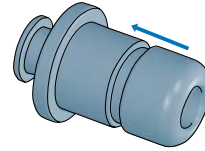
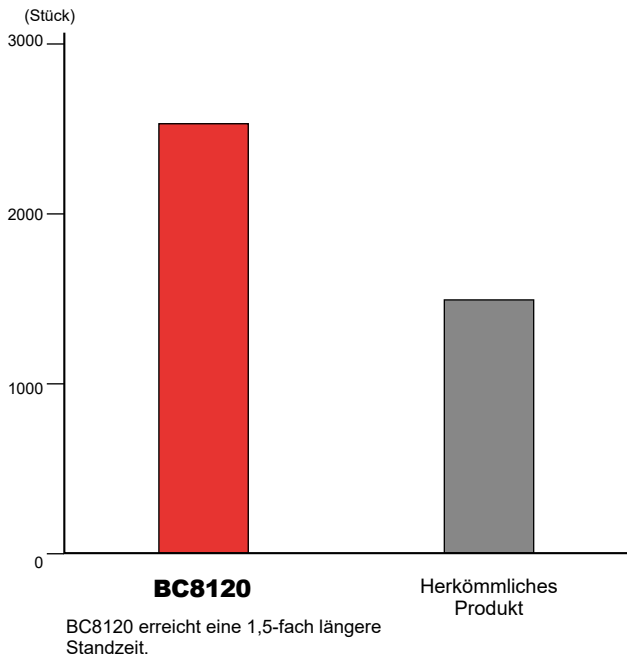

<Schnittdaten>  
 Werkstück : 42CrMoS4 (56-59HRC)  
 Bauteil : Welle  
 (Außenbearbeitung für unterbrochenen Schnitt)  
 WSP : BM-DNGM150608TA2  
 Schnittgeschwindigkeit :  $V_c=170\text{m/min}$   
 Vorschub :  $f=0.15\text{mm/U.}$   
 Schnitttiefe :  $a_p=0.07-0.10\text{mm}$   
 Schnittmodus : Trockenbearbeitung

**B**

PCBN- & PKD-  
WSP FÜR DAS DREHEN

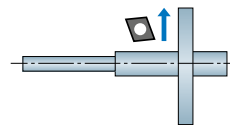
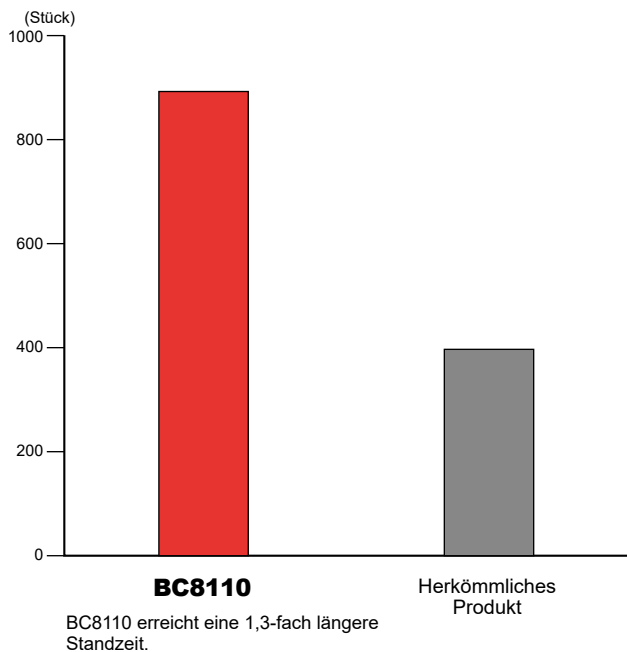

<Schnittdaten>  
 Werkstück : Leg. Stahl (61-65HRC)  
 Bauteil : Welle  
 (Kontinuierliches Plandrehen)  
 WSP : BF-DNGM150404TA2  
 Schnittgeschwindigkeit :  $V_c=150\text{m/min}$   
 Vorschub :  $f=0.12\text{mm/U.}$   
 Schnitttiefe :  $a_p=0.15\text{mm}$   
 Schnittmodus : Nassbearbeitung

# MEHRSCNEIDIGE WENDESCHNEIDPLATTEN

● Eine einseitige, mehrschneidige WSP hat keine Schneiden an der Unterseite.

Doppelseitig mehrschneidige Wendeschneidplatten, z.B.

**NP-CNGA120408GA4**  
 Anzahl der Schneidkanten

Einseitig mehrschneidige Wendeschneidplatten, z.B.

**NP-CNGA120408GA2**  
 Anzahl der Schneidkanten

Doppelseitig mehrschneidige Wendeschneidplatten



# WIPER WSP

## EIGENSCHAFTEN

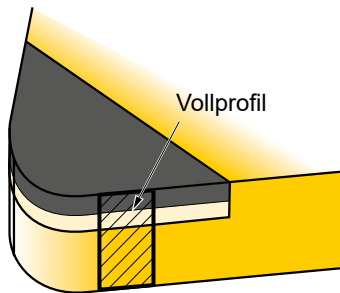

B  
PCBN- & PKD-  
WSP FÜR DAS DREHEN

### Verbesserung der Oberflächengüte

Unter Beibehaltung aller Einsatzdaten kann man die Oberflächengüte verbessern, indem man einzig und allein den Vorschub erhöht.

### Verbesserung der Effizienz

Hohe Vorschübe verkürzen nicht unbedingt die Bearbeitungszeit, es ist allerdings möglich, so die Schrubb- und Schlichtbearbeitung zu kombinieren.

### Erhöhung der Standzeit

Durch den Einsatz von hohen Vorschüben sinkt die erforderliche Bearbeitungszeit pro Teil, sodass mehr Teile mit der gleichen Wendeschneidplatte gefertigt werden können. Zusätzlich beugen die hohen Vorschübe Rattermarken vor, verzögern Verschleiß und verlängern die Standzeit der Wendeschneidplatte.

### Verbesserung der Spankontrolle

Beim Einsatz von hohen Vorschüben werden die Späne dicker und brechen leichter. Demzufolge wird die Spankontrolle verbessert.

## ■ Anwendung von Wiper-WSP

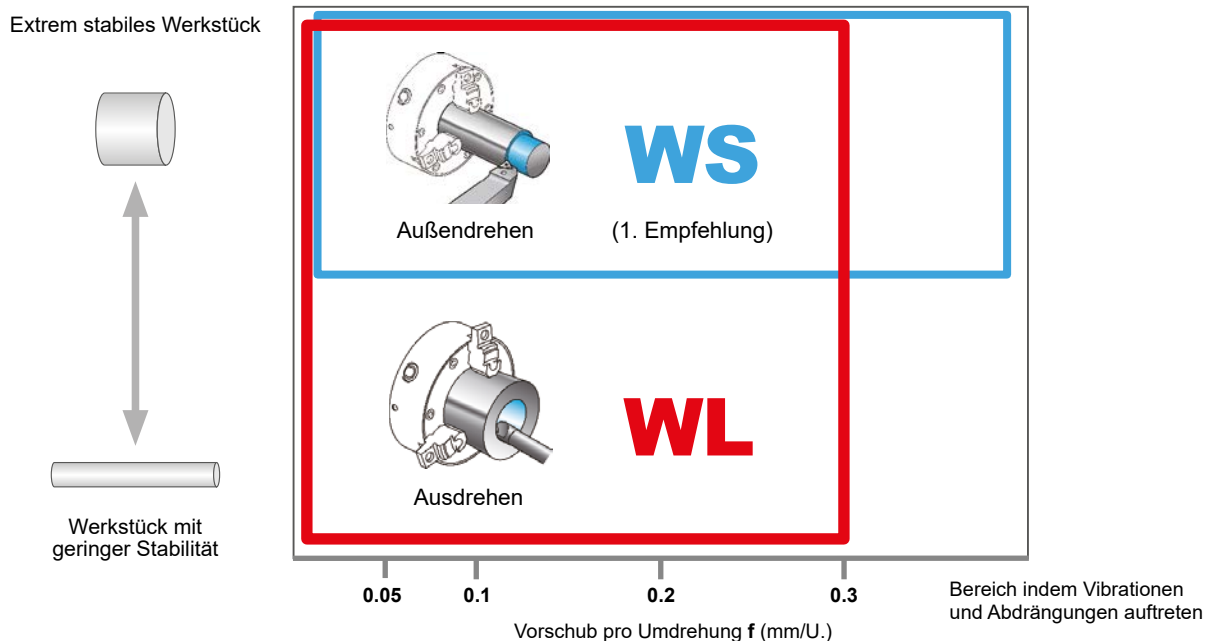

## ■ Wiper-WSP WL

Schützt die Schneidkante vor Vibrationen beim Innen- und Aussendrehen von Werkstücken mit kleinem Durchmesser und bietet eine ausgezeichnete Oberflächengüte in der Fertigbearbeitung an.

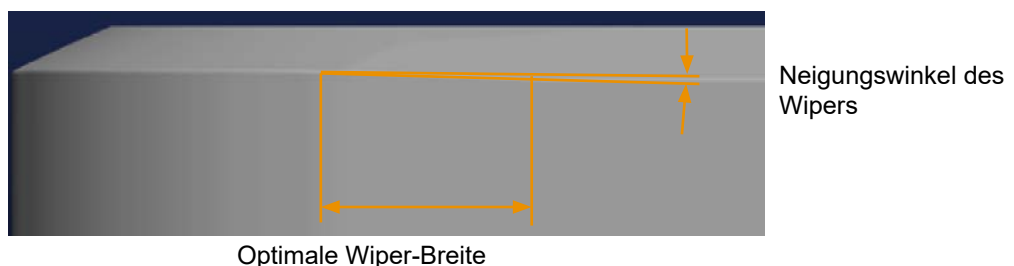

Durch leichte Neigung der Wiper-Schneidkante verringert sich der Schnittwiderstand.



## ■ Schnittleistung

### WS Wiper (Außendrehen)

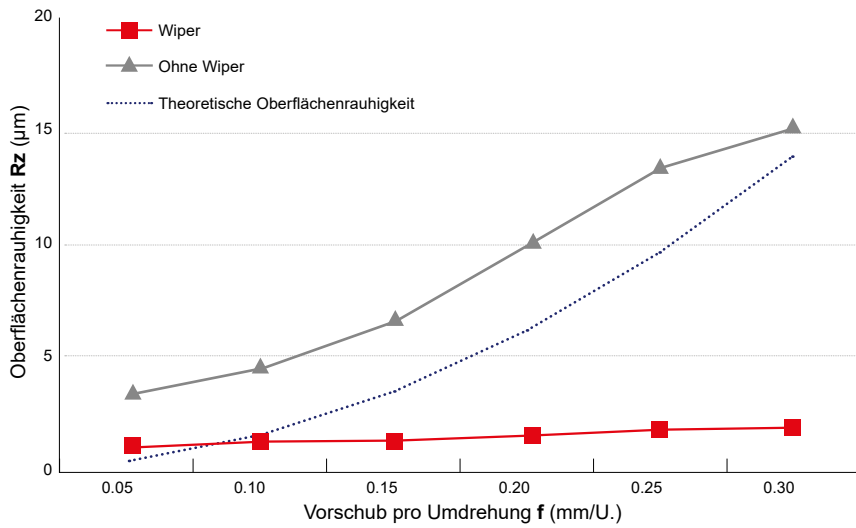

<Schnittdaten>

Werkstück : Gehärteter Stahl (60HRC)  
 WSP : NP-CNGA120408  
 Bearbeitungsmethode : Kontinuierlich  
 Schnittgeschwindigkeit :  $V_c = 120\text{m/min}$   
 Schnitttiefe :  $a_p = 0.1\text{mm}$   
 Schnittmodus : Trockenbearbeitung

### WL Wiper (Innendrehen)

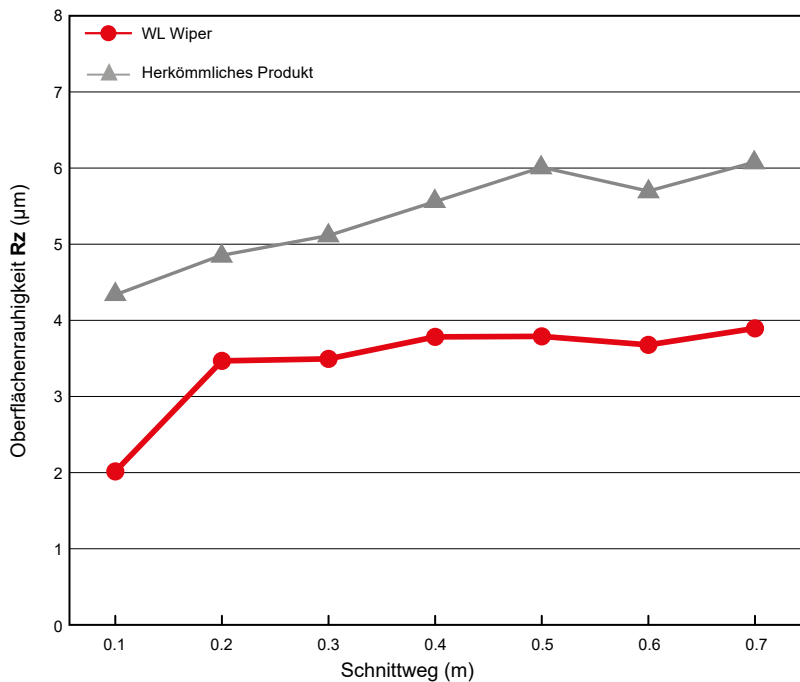

<Schnittdaten>

Werkstück : 16MnCr5 (60HRC)  
 WSP : NP-CNGA120408FBWL2  
 Bearbeitungsmethode : Kontinuierlich  
 Schnittgeschwindigkeit :  $V_c = 160\text{m/min}$   
 Vorschub :  $f = 0.3\text{mm/U.}$   
 Schnitttiefe :  $a_p = 0.1\text{mm}$   
 Schnittmodus : Trockenbearbeitung

Stabile Oberflächenqualität auch bei instabiler Bearbeitung.

## ■ Benutzerhinweise

### Keine Einschränkungen der Halter

Der Standardhalter kann problemlos verwendet werden.

(\*Ein Doppelklemmhalter wird empfohlen)

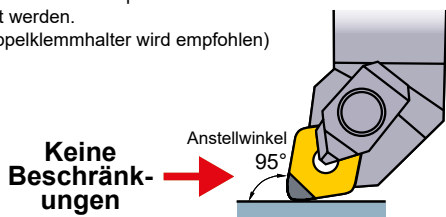

### Einschränkungen der Halter

Um die Wiper-Wendeschneidplatte effizient einzusetzen, verwenden Sie bitte einen Halter mit Anstellwinkel 93°. Ein Halter mit Anstellwinkel 91° kann alternativ den Wiper Effekt verbessern. Mit abweichenden Anstellwinkeln, wie beispielsweise 60°, 90°, 107° usw., kommt der Wiper-Effekt nicht zum Tragen.

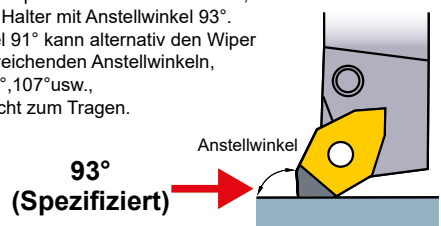



# PCBN EIN- UND ABSTECH WSP (GY/MG)

## EIGENSCHAFTEN

Die Kombination mit einem stabilen Werkzeughalter gewährleistet hohe Präzision und lange Werkzeugstandzeit.

Die Steifigkeit des Halters ist beim Einstechen von gehärtetem Stahl von wesentlicher Bedeutung. Das System aus der GY-Serie bietet die hohe Steifigkeit eines Monoblock-Halters, obwohl es sich um eine zweiteilige Ausführung handelt. Die MG-WSP weisen eine breite Aufnahmefläche für den WSP-Sitz und damit eine höhere Greifkraft auf. Eine Kombination mit diesen Haltern gewährleistet hervorragende Leistung beim Einstechen von gehärtetem Stahl.

**GY-WSP wurden mit BC8110-beschichteten Sorten für die kontinuierliche Bearbeitung von gehärtetem Stahl ergänzt.**

Es wurde die BC8110-Sorte mit hervorragendem Verschleißwiderstand hinzugefügt. Im Vergleich zu herkömmlichen Sorten weisen sie einen hervorragenden Verschleißwiderstand auf, um eine lange Werkzeugstandzeit zu erreichen. Ein Stechschwert von 6 mm wurde ebenfalls in die BC8110-Serie aufgenommen.



**B**  
PCBN- & PKD-  
WSP FÜR DAS DREHEN

## ■ Schnittdatenempfehlungen

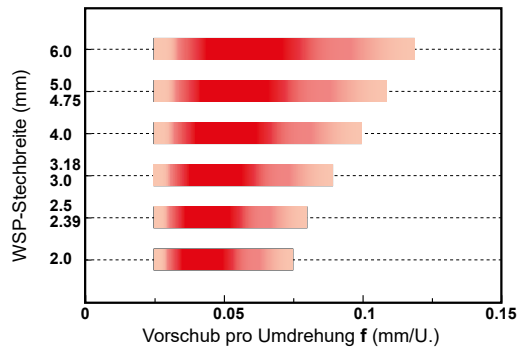

Werkstoff	Härte	Sorte	Schnittgeschw. Vc (m/min)	Schnittmodus
H Gehärteter Stahl	35—65HRC	BC8110	100 (60—120)	Trocken, Nass

## ■ Schnittleistung

Werkzeugstandzeit der GY-Halter

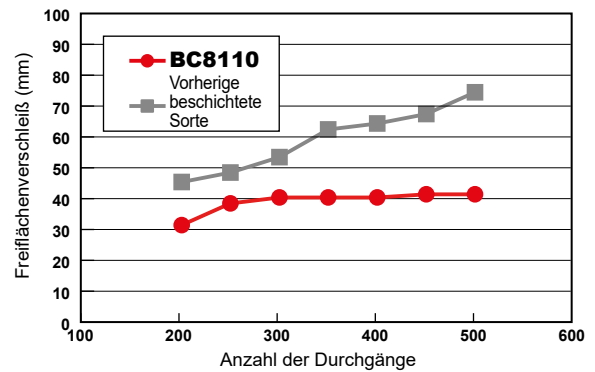

<Schnittdaten>

WSP : GY1G0200D020N-GFGS  
 Werkstück : JIS SG420 (60HRC)  
 Schnittgeschwindigkeit: Vc=120 m/min  
 Vorschub : f=0.1 mm/U.  
 Schnitttiefe : ap=0.3 mm  
 Schnittmodus : Trockenbearbeitung

## ■ Anwendungsbeispiele

WSP	GY1G0300F020N-GFGS (Sorte : BC8110)	
Werkstück	<p>Leg. Stahl (58—62HRC)</p>	
Bauteil	Eingangswelle	
Schnittdaten	Schnittgeschwindigkeit Vc (m/min)	130
	Vorschub f (mm/U.)	0.1
Ergebnis	<p>Mehr als doppelte Werkzeugstandzeit im Vergleich zu herkömmlichen Produkten</p>	

## PKD (GESINTETER DIAMANT)

- Geeignet für Aluminiumleg., Nichteisenmetalle und GFK.
- Geeignet für hohe Schnittgeschwindigkeiten.



### EIGENSCHAFTEN

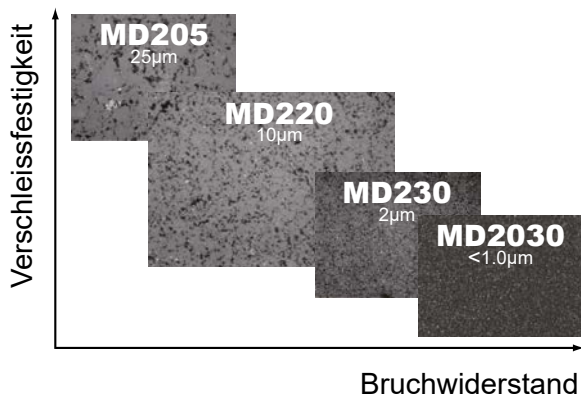

Sorte	Eigenschaften
<b>MD205*</b>	<b>Für kontinuierliche Schnitte</b> Große Diamantpartikel werden gesintert. Das führt zu einem ausgezeichneten Verschleißwiderstand. Geeignet für Anwendungen, wenn der Verschleißwiderstand von MD220 nicht ausreicht.
<b>MD220</b>	<b>Schneidstoff für die Allgemeine Bearbeitung</b> Gesinterte Diamantpartikel mit mittlerer Körnung. Hervorragendes Gleichgewicht zwischen Verschleißwiderstand und Bruchwiderstand. Geeignet für das allgemeine Schlichten von Nichteisenmetallen, die Bearbeitung von nichtmetallischen Werkstoffen und ähnliche Anwendungen.
<b>MD230*</b>	<b>Für den unterbrochenen Schnitt</b> Es werden feinkörnige Diamantpartikel eingesetzt. Dadurch werden ein herausragender Bruchwiderstand und exzellente Schneidkantenschärfe erzielt. Geeignet, wenn beim Einsatz des MD220 Bruchwiderstand und hochwertige Oberflächengüten erforderlich sind.
<b>MD2030</b>	<b>Für schwer unterbrochene Schnitte</b> Das Sinterverfahren von Ultrafeinstkorn-PKD-Partikeln bietet eine außergewöhnliche Bruchfestigkeit und reduziert Ausbrüche während des Hochgeschwindigkeitsfräsens.

\* MD205, MD230: Nicht Standard

### STANDARD AUSWAHL

#### DREHEN

Werkstoff	Empfohlene Sorte			Schnittdatenempfehlungen		
	MD205	MD220	MD2030	Schnittgeschw. Vc (m/min)	Vorschub f (mm/U.)	Schnitttiefe ap (mm)
Aluminiumleg. (Si ≤ 12%)		◎	○	800 (200–1200)	–0.2	–1.0
Aluminiumleg. (Si ≥ 13%)	◎	○		600 (200–1000)	–0.2	–1.0
Kupferleg.		◎		700 (200–1200)	–0.2	–1.0
Verstärkter Kunststoff		◎		600 (100–1000)	–0.4	–1.0
GFK		◎		500 (100–800)	–0.25	–1.0
Graphit	○	◎		400 (100–600)	–0.3	–1.0
Keramik		○		50 (30–80)	–0.1	–1.0
Hartgummi		◎		600 (300–800)	–0.15	–1.0
Spanplatten		◎		1300 (300–4000)	–0.4	–
Hartmetall	◎	○		15 (5–20)	–0.2	–0.5

Hinweis 1) ◎ : 1. Empfehlung ○ : 2. Empfehlung  
Hinweis 2) Nicht geeignet für Stahl.

### PKD NP-WSP-SERIE

- **Wirtschaftlichkeit** Es besteht keine Notwendigkeit eines Nachschleifens.  
Dies vereinfacht das Werkzeug-Management.
- **Mit Spanbrecher** Der auf dem PKD-Teil geformte Spanbrecher sorgt für überlegene Spankontrolle.
- WSP mit R0.05mm sind lieferbar und eignen sich für die Bearbeitung von Werkstücken mit kleinen Radien.



























# Notizen

---

A series of horizontal dashed lines for writing notes, spanning the width of the page.











# KLASSIFIKATION

## NEGATIVE WSP MIT LOCH

Produktbezeichnung	Typ	Toleranz	Spanbrecher Bezeichnung und Schnittbild	Rhombus 80°	Rhombus 55°	Viereck 90°	Dreikant 60°	Rhombus 35°	Sechskant 80°	
NP-AUSFÜHRUNG	Mehrschneidentyp "multi-corner" Doppelseitig	G	Glatt	NP-CNGA_04  ↻ B036	NP-DNGA_04  ↻ B039		NP-TNGA_06  ↻ B044	NP-VNGA_04  ↻ B046	NP-WNGA_06  ↻ B048	
	Mehrschneidentyp "multi-corner" Doppelseitig Mit Wiper		Glatt	NP-CNGA_0W04  ↻ B036						
	Mehrschneidentyp "multi-corner" Einseitig		Glatt	NP-CNGA_02  ↻ B037	NP-DNGA_02  ↻ B040	NP-SNGA_02  ↻ B043	NP-TNGA_03  ↻ B044	NP-VNGA_02  ↻ B046	NP-WNGA_03  ↻ B048	
	Mehrschneidentyp "multi-corner" Einseitig Mit Wiper		Glatt	NP-CNGA_0W02  ↻ B038	NP-DNGA_0WS2J_RL  ↻ B042				NP-WNGA_0WS3  ↻ B048	
	Mehrschneidentyp "multi-corner" Einseitig Mit Spanbrecher		BF	BF-CNGM_02  ↻ B038	BF-DNGM_02  ↻ B042					
	Mehrschneidige Ausführung Einseitig Mit Spanbrecher Mit Wiper		BF	BF-CNGM_0WS2  ↻ B038	BF-DNGM_0WS2  ↻ B042					
	Mehrschneidentyp "multi-corner" Einseitig Mit Spanbrecher		BM	BM-CNGM_02  ↻ B038	BM-DNGM_02  ↻ B042			BM-TNGM_03  ↻ B045		
	Einschneidig Einseitig Mit Spanbrecher		M	R-F	NP-CNMM_R-F  ↻ B064	NP-DNMM_R-F  ↻ B064	NP-SNMM_R-F  ↻ B065	NP-TNMM_R-F  ↻ B065	NP-VNMM_R-F  ↻ B066	

B  
PCBN- & PKD-  
WSP FÜR DAS DREHEN





## NEGATIVE WSP MIT LOCH

Produktbezeichnung	Typ	Toleranz	Spanbrecher Bezeichnung und Schnittbild	Rhombus 80°	Rhombus 55°	Viereck 90°	Dreieck 60°	Rhombus 35°	Sechskant 80°
STANDARD	Mehrschneidentyp "multi-corner" Doppelseitig (Voll-PCBN)	G	Glatt 	CNGA  ↻ B038		SNGA  ↻ B043	TNGA  ↻ B045		
	Einschneidig Einseitig	M	Glatt 	CNMA  ↻ B064					
	Einschneidig Einseitig	G	Glatt 		DNGA  ↻ B064		TNGA  ↻ B065	VNGA  ↻ B066	

PCBN- & PKD- WSP FÜR DAS DREHEN

B

































## 5° POSITIVE WENDESCHNEIDPLATTEN MIT LOCH

Produktbezeichnung	Typ	Toleranz	Spanbrecher Bezeichnung und Schnittbild	Rhombus 80°	Rhombus 55°	Viereck 90°	Dreieck 60°	Rhombus 35°	Sechskant 80°
NP-AUSFÜHRUNG	Mehrschneidentyp "multi-corner"	G	Glatt 					NP-VBGW_02  ↻ B059	
	Einschneidig Mit Spanbrecher		R-F 					NP-VBGT_R-F  ↻ B071	



# KLASSIFIKATION

## 7° POSITIVE WENDESCHNEIDPLATTEN MIT LOCH

Produktbezeichnung	Typ	Toleranz	Spanbrecher Bezeichnung und Schnittbild	Rhombus 80° 	Rhombus 55° 	Viereck 90° 	Dreikant 60° 	Rhombus 35° 	Sechskant 80° 	
NP-AUSFÜHRUNG	Mehrschneidentyp "multi-corner"	G	Glatt 	NP-CCGW/B_02  ↻ B051	NP-DCGW_02  ↻ B054		NP-TCGW_03  ↻ B056	NP-VCGW_02  ↻ B060		
	Mehrschneidentyp "multi-corner" Mit Wiper		Glatt 	NP-CCGW_0W02  ↻ B052						
	Mehrschneidentyp "multi-corner" Mit Spanbrecher		BF 	BF-CCGT_02  ↻ B052	BF-DCGT_02  ↻ B055					
	Mehrschneidentyp "multi-corner" Mit Spanbrecher		BM 	BM-CCGT_02  ↻ B052	BM-DCGT_02  ↻ B055					
	Einschneidig Mit Spanbrecher	M	Spanbrecher 	NP-CCMH  ↻ B067						
	Einschneidig	G	Glatt 	NP-CCGW_0  ↻ B052	NP-DCGW_0  ↻ B055		NP-TCGW_0  ↻ B056			
	Einschneidig	M	Glatt 						NP-WCMW_0  ↻ B060	
	Einschneidig		Glatt 	NP-CCMW  ↻ B067						
	Einschneidig Mit Spanbrecher		R/L-F 		NP-DCMT_R/L-F  ↻ B068					
Einschneidig Mit Spanbrecher	G	R-F 					NP-VCGT_R-F  ↻ B071			

B

PCBN- & PKD- WSP FÜR DAS DREHEN

## 7° POSITIVE WENDESCHNEIDPLATTEN MIT LOCH

Produktbezeichnung	Typ	Toleranz	Spanbrecher Bezeichnung und Schnittbild	Rhombus 80°	Rhombus 55°	Viereck 90°	Dreieck 60°	Rhombus 35°	Sechskant 80°
STANDARD	Einschneidig	M	Glatt	CCMW	DCMW		TCMW TCGW	VCGW <small>NEW</small>	WCMW
		G		 ↻ B067	 ↻ B068		 ↻ B069	 ↻ B071	 ↻ B072



## 11° POSITIVE WENDESCHNEIDPLATTEN MIT LOCH

Produktbezeichnung	Typ	Toleranz	Spanbrecher Bezeichnung und Schnittbild	Rhombus 80°	Rhombus 55°	Viereck 90°	Dreieck 60°	Rhombus 35°	Sechskant 80°
NP-AUSFÜHRUNG	Mehrschneidentyp "multi-corner"	G	Glatt	NP-CPGB_02			NP-TPGB_03		
	Einschneidig Mit Spanbrecher		Spanbrecher	NP-CPMH					
	Einschneidig Mit Spanbrecher	M	R/L-F				NP-TPMX_R/L-F		
	Einschneidig Mit Spanbrecher		R/L-F				NP-TPMH_R/L-F		
STANDARD	Einschneidig Mit Spanbrecher	G	Spanbrecher	CPGT					WPGT
	Einschneidig		Glatt			SPGX	TPGX		
				 ↻ B067		 ↻ B068	 ↻ B070		 ↻ B072







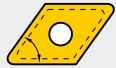

B  
PCBN- & PKD-  
WSP FÜR DAS DREHEN

# KLASSIFIKATION

## 15° POSITIVE WENDESCHNEIDPLATTEN MIT LOCH

Typ	Toleranz	Spanbrecher Bezeichnung und Schnittbild	Rhombus 35°	
Einschneidig (Für Aluminium Mit Spanbrecher)	G	<b>R-F</b> 	 <b>VDGX_R-F</b>  ⊖ B074	





## 20° POSITIVE WENDESCHNEIDPLATTEN MIT LOCH

Typ	Toleranz	Spanbrecher Bezeichnung und Schnittbild	Rhombus 55°	Dreikant 60°
Einschneidig (Für Aluminium Mit Spanbrecher)	G	<b>R/L</b> 		 <b>TEGX_R/L</b>  ⊖ B073
Einschneidig (Für Aluminium Mit Spanbrecher)		<b>R/L-F</b> 	 <b>DEGX_R/L-F</b>  ⊖ B073	
Einschneidig (Für Aluminium)		<b>Glatt</b> 		 <b>TEGX</b>  ⊖ B073

PCBN- & PKD- WSP FÜR DAS DREHEN

B

## NEGATIVE WSP OHNE LOCH

Typ	Toleranz	Spanbrecher Bezeichnung und Schnittbild	Rhombus 80°	Rhombus 55°	Viereck 90°	Dreikant 60°	Rund
Mehrschneidentyp "multi-corner" Doppelseitig (Voll-PCBN)	G	Glatt	CNGN  ↻ B049	DNGN  ↻ B049	SNGN  ↻ B050	TNGN  ↻ B050	RNGN  ↻ B049



## 5° POSITIVE WENDESCHNEIDPLATTEN OHNE LOCH

Typ	Toleranz	Spanbrecher Bezeichnung und Schnittbild	Dreikant 60°
Mehrschneidentyp "multi-corner"	G	Glatt	TBGN  ↻ B062

## WSP FÜR SPEZIELLE ANWENDUNGEN

Halter Ausführung	Toleranz	WSP
GY Typ	G	GY_GFGS  ↻ B063

## 11° POSITIVE WENDESCHNEIDPLATTEN OHNE LOCH

Typ	Toleranz	Spanbrecher Bezeichnung und Schnittbild	Viereck 90°	Dreikant 60°
Mehrschneidentyp "multi-corner"	G	Glatt	NP-SPGN_02  ↻ B061	
Einschneidig	G	Glatt	SPGN  ↻ B061, B075	TPGN  ↻ B062, B075

B

PCBN- & PKD-  
WSP FÜR DAS DREHEN









# 55° DN AUSFÜHRUNG WSP MIT LOCH

Werkstoff	H	Gehärtete Materialien											Schnittbedingungen :					Abmessungen (mm)	Abbildung	Zugehöriger Halter Seite		
	K	Guss											● : Stabile Bearbeitung ● : Allgemeine Bearbeitung ✱ : Instabile Bearbeitung									
Form	S	Hitzebeständige Legierungen, Titanlegierungen Sinterlegierungen	Beschichtet PCBN					PCBN					Voll-PCBN									
			NEW BC8210	BC8220	BC8105	BC8110	BC8120	BC8130	NEW BC5110	NEW MB8110	NEW MB8120	NEW MB8130	MB4120	MB710	MB730	MBS140	IC	S			RE	LE
NP-AUSFÜHRUNG		NP-DNGA150404GS4	★	★	★											12.7	4.76	0.4	2.1	5.16		C010 C011 E015 E038 -040 H009 -011
		NP-DNGA150408GS4	★	★	★											12.7	4.76	0.8	2.0	5.16		
		NP-DNGA150412GS4	★	★	★											12.7	4.76	1.2	1.8	5.16		
		NP-DNGA150604GS4	●	●	●											12.7	6.35	0.4	2.1	5.16		
		NP-DNGA150608GS4	●	●	●											12.7	6.35	0.8	2.0	5.16		
		NP-DNGA150612GS4	●	●	●											12.7	6.35	1.2	1.8	5.16		
		NP-DNGA150404GA4	★		★	★			★							12.7	4.76	0.4	2.1	5.16		
		NP-DNGA150408GA4	★		★	★			★							12.7	4.76	0.8	2.0	5.16		
		NP-DNGA150412GA4	★		★	★			★							12.7	4.76	1.2	1.8	5.16		
		NP-DNGA150604GA4	●		●	●			★							12.7	6.35	0.4	2.1	5.16		
		NP-DNGA150608GA4	●		●	●			★							12.7	6.35	0.8	2.0	5.16		
		NP-DNGA150612GA4	●		●	●			★							12.7	6.35	1.2	1.8	5.16		
		NP-DNGA150404GH4	★	★	★	★	★									12.7	4.76	0.4	2.1	5.16		
		NP-DNGA150408GH4	★	★	★	★	★									12.7	4.76	0.8	2.0	5.16		
		NP-DNGA150412GH4	★	★	★	★	★									12.7	4.76	1.2	1.8	5.16		
		NP-DNGA150604GH4	★	★	★	★	●									12.7	6.35	0.4	2.1	5.16		
		NP-DNGA150608GH4	★	★	★	★	●									12.7	6.35	0.8	2.0	5.16		
		NP-DNGA150612GH4	★	★	★	★	●									12.7	6.35	1.2	1.8	5.16		
	NEW		NP-DNGA150404VA4	★												12.7	4.76	0.4	2.1	5.16		
	NEW		NP-DNGA150408VA4	★												12.7	4.76	0.8	2.0	5.16		
	NEW		NP-DNGA150412VA4	★												12.7	4.76	1.2	1.8	5.16		
	NEW		NP-DNGA150604VA4	★												12.7	6.35	0.4	2.1	5.16		
	NEW		NP-DNGA150608VA4	★												12.7	6.35	0.8	2.0	5.16		
	NEW		NP-DNGA150612VA4	★												12.7	6.35	1.2	1.8	5.16		
			NP-DNGA150404FS4	★	★	★	★		★							12.7	4.76	0.4	2.1	5.16		
			NP-DNGA150408FS4	★	★	★	★		★							12.7	4.76	0.8	2.0	5.16		
			NP-DNGA150412FS4	★	★	★	★		★							12.7	4.76	1.2	1.8	5.16		
			NP-DNGA150604FS4	★	●	★			★							12.7	6.35	0.4	2.1	5.16		
			NP-DNGA150608FS4	★	●	★			★							12.7	6.35	0.8	2.0	5.16		
			NP-DNGA150612FS4	★	●	★			★							12.7	6.35	1.2	1.8	5.16		
			NP-DNGA150404TS4	★		★										12.7	4.76	0.4	2.1	5.16		
			NP-DNGA150408TS4	★		★										12.7	4.76	0.8	2.0	5.16		
			NP-DNGA150412TS4	★		★										12.7	4.76	1.2	1.8	5.16		
		NP-DNGA150604TS4	★		★										12.7	6.35	0.4	2.1	5.16			
		NP-DNGA150608TS4	★		★										12.7	6.35	0.8	2.0	5.16			
		NP-DNGA150612TS4	★		★										12.7	6.35	1.2	1.8	5.16			
		NP-DNGA150404TA4	★		★	★		★	★						12.7	4.76	0.4	2.1	5.16			
		NP-DNGA150408TA4	★		★	★		★	★						12.7	4.76	0.8	2.0	5.16			
		NP-DNGA150412TA4	★		★	★		★	★						12.7	4.76	1.2	1.8	5.16			
		NP-DNGA150604TA4	★		★	●		★							12.7	6.35	0.4	2.1	5.16			
		NP-DNGA150608TA4	★		★	●		★							12.7	6.35	0.8	2.0	5.16			
		NP-DNGA150612TA4	★		★	●		★							12.7	6.35	1.2	1.8	5.16			

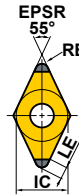
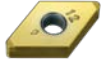

C010  
C011  
E015  
E038  
-040  
H009  
-011

● = NEW

SORTEN > B004  
IDENTIFIKATION > B002

PCBN

B

PCBN-WSP FÜR DAS HARTDREHEN

NEG

MIT LOCH

C

D

R

S

T

V

W

B039



# PCBN-WSP FÜR DAS DREHEN [NEGATIV]

## 55° DN AUSFÜHRUNG WSP MIT LOCH

PCBN

B

PCBN-WSP FÜR DAS  
HARTDREHEN

NEG

MIT  
LOCH

C

D

R

S

T

V

W

Werkstoff	H	Gehärtete Materialien	● ● ● ● ● ●					● ● ● ● ● ●					● ● ● ● ● ●					Schnittbedingungen : ● : Stabile Bearbeitung ● : Allgemeine Bearbeitung ✖ : Instabile Bearbeitung Verfassung (Letzte Ziffer der Bestellnummer) : Siehe Seite B021	Abbildung	Zugehöriger Halter Seite	
	K	Guss	● ● ● ● ● ●					● ● ● ● ● ●					● ● ● ● ● ●								
Form	Bestellbezeichnung	Beschichtet PCBN					PCBN					Voll-PCBN	Abmessungen (mm)					Abbildung	Zugehöriger Halter Seite		
		BC8210 NEW	BC8220	BC8105	BC8110	BC8120	BC8130	BC5110 NEW	MB8110 NEW	MB8120 NEW	MB8130	MB4120	MB710	MB730	MBS140	IC	S			RE	LE
NP-AUSFÜHRUNG	NP-DNGA150404TH4							★							12.7	4.76	0.4	2.1	5.16		C010 C011 E015 E038 -040 H009 -011
	NP-DNGA150408TH4	★		★	★			★							12.7	4.76	0.8	2.0	5.16		
	NP-DNGA150412TH4	★		★	★			★							12.7	4.76	1.2	1.8	5.16		
	NP-DNGA150604TH4				★	★									12.7	6.35	0.4	2.1	5.16		
	NP-DNGA150608TH4	★		★	★										12.7	6.35	0.8	2.0	5.16		
	NP-DNGA150612TH4	★		★	★										12.7	6.35	1.2	1.8	5.16		
NP-AUSFÜHRUNG	NP-DNGA150402GS2	★			★										12.7	4.76	0.2	2.2	5.16		C010 C011 E015 E038 -040 H009 -011
	NP-DNGA150404GS2	★		★	★		★			★					12.7	4.76	0.4	2.1	5.16		
	NP-DNGA150404GS2										★	★			12.7	4.76	0.4	1.5	5.16		
	NP-DNGA150408GS2	★		★	★		★			★					12.7	4.76	0.8	2.0	5.16		
	NP-DNGA150408GS2										★	★			12.7	4.76	0.8	1.7	5.16		
	NP-DNGA150412GS2	★		★	★					★	★	★			12.7	4.76	1.2	1.8	5.16		
	NP-DNGA150604GS2	●		●	●					★	□	●			12.7	6.35	0.4	2.1	5.16		
	NP-DNGA150608GS2	●		●	●		★			●	●	●			12.7	6.35	0.8	2.0	5.16		
	NP-DNGA150612GS2	●		●	●					★	□	●			12.7	6.35	1.2	1.8	5.16		
	NP-DNGA110408GA2	●			●	●		●							9.525	4.76	0.8	2.0	3.81		
	NP-DNGA150402GA2	★		★											12.7	4.76	0.2	2.2	5.16		
	NP-DNGA150404GA2	★		★	★		★								12.7	4.76	0.4	2.1	5.16		
	NP-DNGA150408GA2	★		★	★		★								12.7	4.76	0.8	2.0	5.16		
	NP-DNGA150412GA2	★		★	★		★								12.7	4.76	1.2	1.8	5.16		
	NP-DNGA150602GA2				★										12.7	6.35	0.2	2.2	5.16		
	NP-DNGA150604GA2	●		●	●		●								12.7	6.35	0.4	2.1	5.16		
	NP-DNGA150608GA2	●		●	●		●								12.7	6.35	0.8	2.0	5.16		
	NP-DNGA150612GA2	●		●	●		●								12.7	6.35	1.2	1.8	5.16		
NP-DNGA150404GH2	★	★		★	★	★								12.7	4.76	0.4	2.1	5.16			
NP-DNGA150408GH2	★	★		★	★	★								12.7	4.76	0.8	2.0	5.16			
NP-DNGA150412GH2	★	★		★	★	★								12.7	4.76	1.2	1.8	5.16			
NP-DNGA150604GH2	★	★		★	★	●								12.7	6.35	0.4	2.1	5.16			
NP-DNGA150608GH2	★	★		★	★	●								12.7	6.35	0.8	2.0	5.16			
NP-DNGA150612GH2	★	★		★	★	●								12.7	6.35	1.2	1.8	5.16			

● = NEW

● : Lagerstandard. ★ : Lagerstandard in Japan.

□ : Nichtstandard, Herstellung nur auf Anfrage.







# PCBN-WSP FÜR DAS DREHEN [NEGATIV]

## 

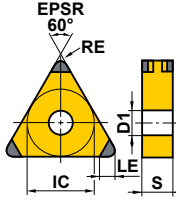
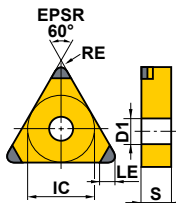
Werkstoff	H	Gehärtete Materialien											Schnittbedingungen : ● : Stabile Bearbeitung ● : Allgemeine Bearbeitung ✱ : Instabile Bearbeitung Verfassung (Letzte Ziffer der Bestellnummer) : Siehe Seite B021									
	K	Guss																				
	S	Hitzebeständige Legierungen, Titanlegierungen Sinterlegierungen																				
Form	Bestellbezeichnung	Beschichtet PCBN			PCBN			Voll-PCBN	Abmessungen (mm)					Abbildung	Zugehöriger Halter Seite							
		NEW BC8210	BC8220	BC8105	BC8110	BC8120	BC8130	NEW BC5110	NEW MB8110	MB8120	MB8130	MB4120	MB710			MB730	MBS140	IC	S	RE	LE	D1
PCBN	NP-AUSFÜHRUNG	NP-TNGA160404GS6	●	●	●											9.525	4.76	0.4	1.6	3.81	 C016 -018 E016 E037	
		NP-TNGA160408GS6	●		●	●											9.525	4.76	0.8	1.7		3.81
		NP-TNGA160412GS6	●		●	●											9.525	4.76	1.2	1.9		3.81
		NP-TNGA160404GA6	●			●	●		★								9.525	4.76	0.4	1.6		3.81
		NP-TNGA160408GA6	●			●	●		★								9.525	4.76	0.8	1.7		3.81
		NP-TNGA160412GA6	●			●	●		★								9.525	4.76	1.2	1.9		3.81
		NP-TNGA160404GH6	★		★	★	★										9.525	4.76	0.4	1.6		3.81
		NP-TNGA160408GH6	★		★	★	★										9.525	4.76	0.8	1.7		3.81
		NP-TNGA160412GH6	★		★	★	★										9.525	4.76	1.2	1.9		3.81
		NEW NP-TNGA160404VA6	★														9.525	4.76	0.4	1.6		3.81
		NEW NP-TNGA160408VA6	★														9.525	4.76	0.8	1.7		3.81
		NEW NP-TNGA160412VA6	★														9.525	4.76	1.2	1.9		3.81
		NP-TNGA160404FS6	★		●	★	★		★								9.525	4.76	0.4	1.6		3.81
		NP-TNGA160408FS6	★		●	★	★		★								9.525	4.76	0.8	1.7		3.81
		NP-TNGA160412FS6	★		●	★	★		★								9.525	4.76	1.2	1.9		3.81
		NP-TNGA160404TS6	★			★											9.525	4.76	0.4	1.6		3.81
		NP-TNGA160408TS6	★			★											9.525	4.76	0.8	1.7		3.81
		NP-TNGA160412TS6	★			★											9.525	4.76	1.2	1.9		3.81
		NP-TNGA160404TA6	★			★	●		★	★							9.525	4.76	0.4	1.6		3.81
		NP-TNGA160408TA6	★			★	●		★	★							9.525	4.76	0.8	1.7		3.81
		NP-TNGA160412TA6	★			★	●		★	★							9.525	4.76	1.2	1.9		3.81
		NP-TNGA160404TH6				★	★			★							9.525	4.76	0.4	1.6		3.81
NP-TNGA160408TH6	★			★	●		★								9.525	4.76	0.8	1.7	3.81			
NP-TNGA160412TH6	★			★	●		★								9.525	4.76	1.2	1.9	3.81			
NEG	NP-AUSFÜHRUNG	NP-TNGA160402GS3	★			★										9.525	4.76	0.2	1.5	3.81	 C016 -018 E016 E037	
		NP-TNGA160404GS3	★		●	★		★		★						9.525	4.76	0.4	1.6	3.81		
		NP-TNGA160408GS3	★		●	★		★		●	★	●				9.525	4.76	0.8	1.7	3.81		
		NP-TNGA160412GS3	★		●	★		★		★	★	★				9.525	4.76	1.2	1.9	3.81		
		NP-TNGA160402GA3	★			★			★							9.525	4.76	0.2	1.5	3.81		
		NP-TNGA160404GA3	●			●	●		★							9.525	4.76	0.4	1.6	3.81		
		NP-TNGA160408GA3	●			●	●		●							9.525	4.76	0.8	1.7	3.81		
		NP-TNGA160412GA3	★			★	●		★							9.525	4.76	1.2	1.9	3.81		
		NP-TNGA160404GH3	★		★	★	●									9.525	4.76	0.4	1.6	3.81		
		NP-TNGA160408GH3	★		★	★	●									9.525	4.76	0.8	1.7	3.81		
		NP-TNGA160412GH3	★		★	★	●									9.525	4.76	1.2	1.9	3.81		
		NEW NP-TNGA160404VA3	★													9.525	4.76	0.4	1.6	3.81		
		NEW NP-TNGA160408VA3	●													9.525	4.76	0.8	1.7	3.81		
		NEW NP-TNGA160412VA3	★													9.525	4.76	1.2	1.9	3.81		
		NP-TNGA160402FS3	★			★			★							9.525	4.76	0.2	1.5	3.81		
		NP-TNGA160404FS3	●		●	●	●		★	★		●				9.525	4.76	0.4	1.6	3.81		
		NP-TNGA160408FS3	●		●	●	●		★	★		★				9.525	4.76	0.8	1.7	3.81		
		NP-TNGA160412FS3	●		●	●	●		★	★		★				9.525	4.76	1.2	1.9	3.81		

● = NEW

● : Lagerstandard. ★ : Lagerstandard in Japan.

PCBN

B

PCBN-WSP FÜR DAS HARTDREHEN

NEG

MIT LOCH

C

D

R

S

T

V

W

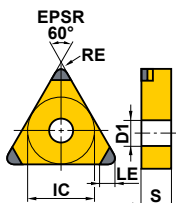
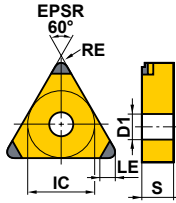

Werkstoff	H	Gehärtete Materialien	●	●	●	●	●	●	●	●	●	●	●	●	●	●	●	●	●	Schnittbedingungen :					Abmessungen (mm)	Abbildung	Zugehöriger Halter Seite		
	K	Guss																	●	●	●	IC	S	RE				LE	D1
Form	S	Hitzebeständige Legierungen, Titanlegierungen																		Verfassung (Letzte Ziffer der Bestellnummer) :					Abbildung	Zugehöriger Halter Seite			
	Sinterlegierungen																		●	●	●	IC	S	RE			LE	D1	
NP-AUSFÜHRUNG			Beschichtet PCBN																PCBN										C016 -018 E016 E037
	<b>NP-TNGA160404TS3</b>	●	●																										
	<b>NP-TNGA160408TS3</b>	●	●																										
	<b>NP-TNGA160412TS3</b>	●	●																										
	<b>NP-TNGA160404TA3</b>	●	●																										
	<b>NP-TNGA160408TA3</b>	●	●																										
	<b>NP-TNGA160412TA3</b>	●	●																										
	<b>NP-TNGA160404TH3</b>																												
	<b>NP-TNGA160408TH3</b>	*	*																										
	<b>NP-TNGA160412TH3</b>	*	*																										
	<b>NP-TNGA160404SF3</b>																												
	<b>NP-TNGA160408SF3</b>																												
	<b>NP-TNGA160412SF3</b>																												
	<b>NP-TNGA160404SE3</b>																												
<b>NP-TNGA160408SE3</b>																													
<b>NP-TNGA160412SE3</b>																													
NP-AUSFÜHRUNG																			PCBN										C016 -018 E016 E037
	<b>BM-TNGM160408TA3</b>		●																										



(Mit Spanbrecher)



● = NEW

PCBN

B

PCBN-WSP FÜR DAS HARTDREHEN

NEG

MIT LOCH

C

D

R

S

T

V

W



# PCBN-WSP FÜR DAS DREHEN [NEGATIV]



## 35° VN AUSFÜHRUNG WSP MIT LOCH

Werkstoff	H	Gehärtete Materialien											Schnittbedingungen :					Abmessungen (mm)	Abbildung	Zugehöriger Halter Seite				
	K	Guss											● : Stabile Bearbeitung ● : Allgemeine Bearbeitung ✱ : Instabile Bearbeitung											
Form	S	Hitzebeständige Legierungen, Titanlegierungen Sinterlegierungen											Verfassung (Letzte Ziffer der Bestellnummer) :					IC	S	RE	LE	D1		
	Beschichtet PCBN		PCBN					Voll-PCBN	Verfassung (Letzte Ziffer der Bestellnummer) :															
Bestellbezeichnung		NEW BC8210	BC8220	BC8105	BC8110	BC8120	BC8130	NEW BC5110	NEW MB8110	MB8120	MB8130	MB4120	MB710	MB730	MBS140						Abbildung	Zugehöriger Halter Seite		
PCBN B PCBN-WSP FÜR DAS HARTDREHEN NEG MIT LOCH C D R S T V W	NP-AUSFÜHRUNG	NP-VNGA16040GS4	★		●	★										9.525	4.76	0.4	2.5	3.81			 C019 -021 E017	
	NP-VNGA16040GS4	●		●	●											9.525	4.76	0.8	2.0	3.81				
	NP-VNGA160412GS4	★			★											9.525	4.76	1.2	1.5	3.81				
	NP-VNGA16040GA4		●			●	●		★							9.525	4.76	0.4	2.5	3.81				
	NP-VNGA160408GA4		●			●	●		★							9.525	4.76	0.8	2.0	3.81				
	NP-VNGA160412GA4		●			●	●		★							9.525	4.76	1.2	1.5	3.81				
	NP-VNGA16040GH4		★		★	★	★									9.525	4.76	0.4	2.5	3.81				
	NP-VNGA160408GH4		★		★	★	★									9.525	4.76	0.8	2.0	3.81				
	NP-VNGA160412GH4				★	★	★									9.525	4.76	1.2	1.5	3.81				
	NEW NP-VNGA16040VA4		★													9.525	4.76	0.4	2.5	3.81				
	NEW NP-VNGA160408VA4		★													9.525	4.76	0.8	2.0	3.81				
	NEW NP-VNGA160412VA4		★													9.525	4.76	1.2	1.5	3.81				
	NP-VNGA16040FS4		★		●	★	★		★							9.525	4.76	0.4	2.5	3.81				
	NP-VNGA160408FS4		★		●	★	★		★							9.525	4.76	0.8	2.0	3.81				
	NP-VNGA160412FS4					★										9.525	4.76	1.2	1.5	3.81				
	NP-VNGA16040TS4		★			★										9.525	4.76	0.4	2.5	3.81				
	NP-VNGA160408TS4		★			★										9.525	4.76	0.8	2.0	3.81				
	NP-VNGA16040TA4			★		★	●		★							9.525	4.76	0.4	2.5	3.81				
	NP-VNGA160408TA4			★		★	●		★							9.525	4.76	0.8	2.0	3.81				
	NP-VNGA160412TA4					★	●		★							9.525	4.76	1.2	1.5	3.81				
NP-VNGA16040TH4			★		★	★									9.525	4.76	0.4	2.5	3.81					
NP-VNGA160408TH4			★		★	★									9.525	4.76	0.8	2.0	3.81					
NP-VNGA160412TH4					★	★									9.525	4.76	1.2	1.5	3.81					
NP-AUSFÜHRUNG	NP-VNGA160402GS2	★			★										9.525	4.76	0.2	2.5	3.81	 C019 -021 E017				
NP-VNGA160404GS2	●		●	●		★			★						9.525	4.76	0.4	2.5	3.81					
NP-VNGA160408GS2	●		●	●		★			★						9.525	4.76	0.8	2.0	3.81					
NP-VNGA160412GS2	★			★											9.525	4.76	1.2	1.5	3.81					
NP-VNGA160402GA2		●			●			★							9.525	4.76	0.2	2.5	3.81					
NP-VNGA160404GA2		●			●	●		★							9.525	4.76	0.4	2.5	3.81					
NP-VNGA160408GA2		●			●	●		★							9.525	4.76	0.8	2.0	3.81					
NP-VNGA160412GA2		★			★	★		★							9.525	4.76	1.2	1.5	3.81					
NP-VNGA160404GH2		★		★	★	★									9.525	4.76	0.4	2.5	3.81					
NP-VNGA160408GH2		★		★	★	★									9.525	4.76	0.8	2.0	3.81					
NP-VNGA160412GH2				★	★	★									9.525	4.76	1.2	1.5	3.81					
NEW NP-VNGA16040VA2		●													9.525	4.76	0.4	2.5	3.81					
NEW NP-VNGA160408VA2		●													9.525	4.76	0.8	2.0	3.81					
NEW NP-VNGA160412VA2		★													9.525	4.76	1.2	1.5	3.81					
NP-VNGA160402FS2		★			★			★							9.525	4.76	0.2	2.5	3.81					
NP-VNGA160404FS2		★		●	★	●		★	★		★				9.525	4.76	0.4	2.5	3.81					
NP-VNGA160408FS2		★		●	★	●		★	★		●				9.525	4.76	0.8	2.0	3.81					
NP-VNGA160412FS2					★										9.525	4.76	1.2	1.5	3.81					

● = NEW

● : Lagerstandard. ★ : Lagerstandard in Japan.







# 80° CN AUSFÜHRUNG WSP OHNE LOCH

Werkstoff	H	Gehärtete Materialien	● ● ● ● ● ● ✱	● ● ● ✱	● ● ● ● ✱	● ● ● ● ✱	Schnittbedingungen : ● : Stabile Bearbeitung ● : Allgemeine Bearbeitung ✱ : Instabile Bearbeitung	Abmessungen (mm)				Abbildung	Zugehöriger Halter Seite				
	K	Guss															
	S	Hitzebeständige Legierungen, Titanlegierungen															
		Sinterlegierungen		●													
Form	Bestellbezeichnung	Beschichtet PCBN			PCBN			Voll-PCBN									
		NEW BC8210	BC8220	BC8105	BC8110	BC8120	BC8130	NEW BC5110	NEW MB8110	MB8120	MB8130	MB4120	MB710	MB730	MBS140		
		IC	S	RE	LE												
	CNGN120404									●	12.7	4.76	0.4	—		—	
	CNGN120408									●	12.7	4.76	0.8	—			
	CNGN120412										●	12.7	4.76	1.2			—

● = NEW

PCBN

B

PCBN-WSP FÜR DAS HARTDREHEN

# 55° DN AUSFÜHRUNG WSP OHNE LOCH

Werkstoff	H	Gehärtete Materialien	● ● ● ● ● ● ✱	● ● ● ✱	● ● ● ● ✱	● ● ● ● ✱	Schnittbedingungen : ● : Stabile Bearbeitung ● : Allgemeine Bearbeitung ✱ : Instabile Bearbeitung	Abmessungen (mm)				Abbildung	Zugehöriger Halter Seite				
	K	Guss															
	S	Hitzebeständige Legierungen, Titanlegierungen															
		Sinterlegierungen		●													
Form	Bestellbezeichnung	Beschichtet PCBN			PCBN			Voll-PCBN									
		NEW BC8210	BC8220	BC8105	BC8110	BC8120	BC8130	NEW BC5110	NEW MB8110	MB8120	MB8130	MB4120	MB710	MB730	MBS140		
		IC	S	RE	LE												
	DNGN110308										★	9.525	3.18	0.8	—		—
	DNGN110312										★	9.525	3.18	1.2	—		

● = NEW

NEG

OHNE LOCH

C

D

R

S

T

V

W

# RN AUSFÜHRUNG WSP OHNE LOCH

Werkstoff	H	Gehärtete Materialien	● ● ● ● ● ● ✱	● ● ● ✱	● ● ● ● ✱	● ● ● ● ✱	Schnittbedingungen : ● : Stabile Bearbeitung ● : Allgemeine Bearbeitung ✱ : Instabile Bearbeitung	Abmessungen (mm)				Abbildung	Zugehöriger Halter Seite					
	K	Guss																
	S	Hitzebeständige Legierungen, Titanlegierungen																
		Sinterlegierungen		●														
Form	Bestellbezeichnung	Beschichtet PCBN			PCBN			Voll-PCBN										
		NEW BC8210	BC8220	BC8105	BC8110	BC8120	BC8130	NEW BC5110	NEW MB8110	MB8120	MB8130	MB4120	MB710	MB730	MBS140			
		IC	S	RE	LE													
	RNGN090300										●	9.525	3.18	—	—		—	
	RNGN120300										●	12.7	3.18	—	—			
	RNGN120400											●	12.7	4.76	—			—

● = NEW

SORTEN > B004  
IDENTIFIKATION > B002

B049

# PCBN-WSP FÜR DAS DREHEN [NEGATIV]

## 90° SN AUSFÜHRUNG WSP OHNE LOCH

PCBN

B

PCBN-WSP FÜR DAS  
HARTDREHEN

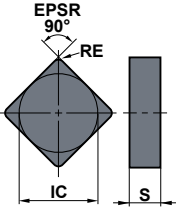
Werkstoff	H	Gehärtete Materialien	● ● ● ● ● ● ✱	● ● ● ✱	● ● ● ● ✱	● ● ● ● ✱	Schnittbedingungen : ● : Stabile Bearbeitung ● : Allgemeine Bearbeitung ✱ : Instabile Bearbeitung	Abmessungen (mm)				Abbildung	Zugehöriger Halter Seite		
	K	Guss						IC	S	RE	LE				
Form	S	Hitzebeständige Legierungen, Titanlegierungen													
		Sinterlegierungen													
Form	Bestellbezeichnung	Beschichtet PCBN	PCBN				Voll-PCBN	Abmessungen (mm)				Abbildung	Zugehöriger Halter Seite		
		NEW	NEW	NEW	NEW		IC	S	RE	LE					
	SNGN090308							●	9.525	3.18	0.8	—		—	
	SNGN090312							●	9.525	3.18	1.2	—			
	SNGN090316								●	9.525	3.18	1.6			—
	SNGN090408								★	9.525	4.76	0.8			—
	SNGN090412								★	9.525	4.76	1.2			—
	SNGN120408								●	12.7	4.76	0.8			—
	SNGN120412								●	12.7	4.76	1.2			—
	SNGN120416								●	12.7	4.76	1.6			—

● = NEW

NEG

OHNE  
LOCH

C

D

R

S

T

V

W

## 60° TN AUSFÜHRUNG WSP OHNE LOCH

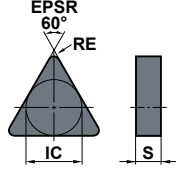
Werkstoff	H	Gehärtete Materialien	● ● ● ● ● ● ✱	● ● ● ✱	● ● ● ● ✱	● ● ● ● ✱	Schnittbedingungen : ● : Stabile Bearbeitung ● : Allgemeine Bearbeitung ✱ : Instabile Bearbeitung	Abmessungen (mm)				Abbildung	Zugehöriger Halter Seite	
	K	Guss						IC	S	RE	LE			
Form	S	Hitzebeständige Legierungen, Titanlegierungen												
		Sinterlegierungen												
Form	Bestellbezeichnung	Beschichtet PCBN	PCBN				Voll-PCBN	Abmessungen (mm)				Abbildung	Zugehöriger Halter Seite	
		NEW	NEW	NEW	NEW		IC	S	RE	LE				
	TNGN160408							●	9.525	4.76	0.8	—		—
	TNGN160412							●	9.525	4.76	1.2	—		
	TNGN160416								●	9.525	4.76	1.6		

● = NEW

● : Lagerstandard. ★ : Lagerstandard in Japan.

□ : Nichtstandard, Herstellung nur auf Anfrage.



# PCBN-WSP FÜR DAS DREHEN [POSITIV]

## 80° CC AUSFÜHRUNG WSP MIT LOCH

PCBN

B

PCBN-WSP FÜR DAS HARTDREHEN

POSITIV 7°

MIT LOCH

C

D

R

S

T

V

W

Werkstoff	H	Gehärtete Materialien	● ● ● ● ● ●					● ● ● ● ● ●					● ● ● ● ● ●					Schnittbedingungen : ● : Stabile Bearbeitung ● : Allgemeine Bearbeitung ✱ : Instabile Bearbeitung ● : Verfärbung (Letzte Ziffer der Bestellnummer) : Siehe Seite B021		
	K	Guss	● ● ● ● ● ●					● ● ● ● ● ●					● ● ● ● ● ●							
Form	S	Hitzebeständige Legierungen, Titanlegierungen	● ● ● ● ● ●					● ● ● ● ● ●					● ● ● ● ● ●					Abbildung	Zugehöriger Halter Seite	
		Sinterlegierungen	● ● ● ● ● ●					● ● ● ● ● ●					● ● ● ● ● ●							
Form	Bestellbezeichnung	Beschichtet PCBN					PCBN					Abmessungen (mm)					Abbildung	Zugehöriger Halter Seite		
		NEW BC8210	BC8220	BC8105	BC8110	BC8120	BC8130	NEW BC5110	NEW MB8110	MB8120	MB8130	MB4120	MB710	MB730	IC	S			RE	LE
NP-AUSFÜHRUNG	NP-CCGW09T304SE2										✱			9.525	3.97	0.4	1.8	4.4		C024 D010 E007 E008 E032 E036
	NP-CCGW09T308SE2										●			9.525	3.97	0.8	2.0	4.4		
NP-AUSFÜHRUNG (Vollprofil) *1	NP-CCGW09T304GSWS2	●	●	●										9.525	3.97	0.4	1.8	4.4		C024 D010 E032 E036
	NP-CCGW09T308GSWS2	●	●	●										9.525	3.97	0.8	2.0	4.4		
	NP-CCGW09T304GWS2	●		●	●			★						9.525	3.97	0.4	1.8	4.4		
	NP-CCGW09T308GWS2	●		●	●			★						9.525	3.97	0.8	2.0	4.4		
	NP-CCGW09T304GBWL2			★	★	★			★					9.525	3.97	0.4	1.8	4.4		
	NP-CCGW09T308GBWL2			★	★	★			★					9.525	3.97	0.8	2.0	4.4		
	NP-CCGW09T304FSWS2	●	●	★	★			★						9.525	3.97	0.4	1.8	4.4		
	NP-CCGW09T308FSWS2	●	●	★	★			★						9.525	3.97	0.8	2.0	4.4		
	NP-CCGW09T304FBWL2			★	★	★			★					9.525	3.97	0.4	1.8	4.4		
NP-CCGW09T308FBWL2			★	★	★			★					9.525	3.97	0.8	2.0	4.4			
NP-AUSFÜHRUNG	BF-CCGT09T304TS2	●		●										9.525	3.97	0.4	1.8	4.4		C024 D010 E032 E036
	BF-CCGT09T308TS2	●		●										9.525	3.97	0.8	2.0	4.4		
NP-AUSFÜHRUNG	BM-CCGT09T304TA2	●		●										9.525	3.97	0.4	1.8	4.4		C024 D010 E032 E036
	BM-CCGT09T308TA2	●		●										9.525	3.97	0.8	2.0	4.4		
NP-AUSFÜHRUNG	* NP-CCGW03S102GS		●											3.57	1.39	0.2	1.1	2.0		E018
	* NP-CCGW03S104GS		●											3.57	1.39	0.4	1.0	2.0		
	* NP-CCGW04T002GS		●											4.37	1.79	0.2	1.5	2.4		
	* NP-CCGW04T004GS		●											4.37	1.79	0.4	1.4	2.4		
	* NP-CCGW03S102FS	●		●				★						3.57	1.39	0.2	1.1	2.0		
	* NP-CCGW03S104FS	●		●				●						3.57	1.39	0.4	1.0	2.0		
	* NP-CCGW04T002FS	●		●				●						4.37	1.79	0.2	1.5	2.4		
* NP-CCGW04T004FS	●		●				●						4.37	1.79	0.4	1.4	2.4			

\*1 Vor dem Einsatz der Wiper-WSP beachten Sie bitte Seite B024.

\* Der Durchmesser des Innenkreises entspricht nicht dem ISO-Standard. (Für SCLC-Typ)

● = NEW

● : Lagerstandard. ★ : Lagerstandard in Japan.













# PCBN-WSP FÜR DAS DREHEN [POSITIV]

## 60° TP AUSFÜHRUNG WSP MIT LOCH

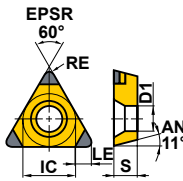
Werkstoff	H	Gehärtete Materialien	● ● ● ● ● ●					● ● ● ● ● ●					● ● ● ● ● ●					Schnittbedingungen : ● : Stabile Bearbeitung ● : Allgemeine Bearbeitung ✱ : Instabile Bearbeitung ● : Verfassung (Letzte Ziffer der Bestellnummer) : Siehe Seite B021					
	K	Guss	● ● ● ● ● ●					● ● ● ● ● ●					● ● ● ● ● ●										
Form	S	Hitzebeständige Legierungen, Titanlegierungen	● ● ● ● ● ●					● ● ● ● ● ●					● ● ● ● ● ●					Abbildung	Zugehöriger Halter Seite				
		Sinterlegierungen	● ● ● ● ● ●					● ● ● ● ● ●					● ● ● ● ● ●										
Form	Bestellbezeichnung	Beschichtet PCBN					PCBN					Abmessungen (mm)					Abbildung	Zugehöriger Halter Seite					
		NEW	NEW	NEW	NEW	NEW	NEW	NEW	NEW	NEW	NEW	NEW	NEW	NEW	NEW	NEW			IC	S	RE	LE	D1
PCBN	NP-AUSFÜHRUNG		NP-TPGB090202SF3											★			5.56	2.38	0.2	1.5	2.9		E009
			NP-TPGB090204SF3											★			5.56	2.38	0.4	1.6	2.9		
			NP-TPGB110302SF3											★			6.35	3.18	0.2	1.5	3.4		
			NP-TPGB110304SF3											★			6.35	3.18	0.4	1.6	3.4		
			NP-TPGB110308SF3											★			6.35	3.18	0.8	1.7	3.4		
			NP-TPGB090202SE3											★			5.56	2.38	0.2	1.5	2.9		
			NP-TPGB090204SE3											★			5.56	2.38	0.4	1.6	2.9		
			NP-TPGB110302SE3											★			6.35	3.18	0.2	1.5	3.4		
			NP-TPGB110304SE3											★			6.35	3.18	0.4	1.6	3.4		
			NP-TPGB110308SE3											★			6.35	3.18	0.8	1.7	3.4		

● = NEW

PCBN

B

PCBN-WSP FÜR DAS HARTDREHEN

POSI 11°

MIT LOCH

C

D

R

S

T

V

W

● : Lagerstandard. ★ : Lagerstandard in Japan.

















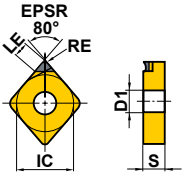

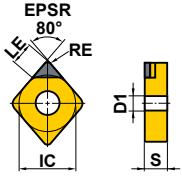
# PKD-WSP FÜR DAS DREHEN [NEGATIV]

## 80° CN AUSFÜHRUNG WSP MIT LOCH

Werkstoff	N	Nicht-Eisen-Metalle	PKD	Abmessungen (mm)					Abbildung	Zugehöriger Halter Seite
				IC	S	RE	LE	D1		
NP-AUSFÜHRUNG  (Mit Spanbrecher)			★	12.7	4.76	0.2	1.7	5.16	 Abbildung zeigt rechte WSP.	C008 C009 E015 E038 H006 -008
			★	12.7	4.76	0.4	1.8	5.16		
			★	12.7	4.76	0.8	2.0	5.16		
			★	12.7	4.76	0.4	3.6	5.16	 Abbildung zeigt rechte WSP.	C008 C009 E015 E038 H006 -008
			★	12.7	4.76	0.8	3.6	5.16		

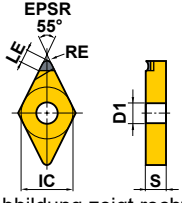
## 55° DN AUSFÜHRUNG WSP MIT LOCH

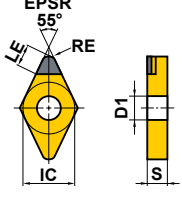
Werkstoff	N	Nicht-Eisen-Metalle	PKD	Abmessungen (mm)					Abbildung	Zugehöriger Halter Seite
				IC	S	RE	LE	D1		
NP-AUSFÜHRUNG  (Mit Spanbrecher)			★	12.7	4.76	0.2	2.2	5.16	 Abbildung zeigt rechte WSP.	C010 C011 E015 E038 -040 H009 H010
			★	12.7	4.76	0.4	2.1	5.16		
			★	12.7	4.76	0.8	2.0	5.16		
			★	12.7	4.76	0.4	2.9	5.16	 Abbildung zeigt rechte WSP.	C010 C011 E015 E038 -040 H009 H010
			★	12.7	4.76	0.8	2.4	5.16		

★ : Lagerstandard in Japan.

# 90° SN AUSFÜHRUNG WSP MIT LOCH

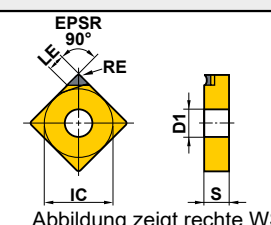
Werkstoff	N	Nicht-Eisen-Metalle	●	Schnittbedingungen :					
				● : Stabile Bearbeitung	● : Allgemeine Bearbeitung	✦ : Instabile Bearbeitung			
Form	Bestellbezeichnung	PKD	Abmessungen (mm)					Abbildung	Zugehöriger Halter Seite
		MD220	IC	S	RE	LE	D1		
NP-AUSFÜHRUNG	NP-SNMM120404R-F	★	12.7	4.76	0.4	2.0	5.16	 <p>Abbildung zeigt rechte WSP.</p>	C012 -015 E016 E037
	NP-SNMM120408R-F	★	12.7	4.76	0.8	2.2	5.16		



(Mit Spanbrecher)

PKD

B

PKD-WSP FÜR DAS DREHEN

NEG

MIT  
LOCH

C

D

R

S

T

V

W

# 60° TN AUSFÜHRUNG WSP MIT LOCH

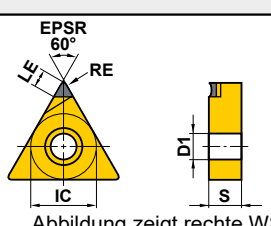
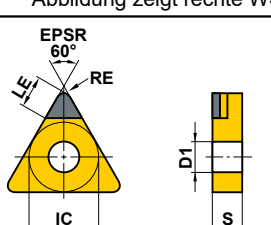
Werkstoff	N	Nicht-Eisen-Metalle	●	Schnittbedingungen :					
				● : Stabile Bearbeitung	● : Allgemeine Bearbeitung	✦ : Instabile Bearbeitung			
Form	Bestellbezeichnung	PKD	Abmessungen (mm)					Abbildung	Zugehöriger Halter Seite
		MD220	IC	S	RE	LE	D1		
NP-AUSFÜHRUNG	NP-TNMM160402R-F	★	9.525	4.76	0.2	1.5	3.81	 <p>Abbildung zeigt rechte WSP.</p>	C016 -018 E016 E037
	NP-TNMM160404R-F	★	9.525	4.76	0.4	1.6	3.81		
	NP-TNMM160408R-F	★	9.525	4.76	0.8	1.7	3.81		
	TNGA160402	★	9.525	4.76	0.2	3.1	3.81		C016 -018 E016 E037
	TNGA160404	★	9.525	4.76	0.4	2.9	3.81		
	TNGA160408	★	9.525	4.76	0.8	2.8	3.81		



(Mit Spanbrecher)



SORTEN > B028  
IDENTIFIKATION > B002

B065

# PKD-WSP FÜR DAS DREHEN [NEGATIV]



## 35° VN AUSFÜHRUNG WSP MIT LOCH

Werkstoff	N	Nicht-Eisen-Metalle	●	Schnittbedingungen :						
				● : Stabile Bearbeitung	● : Allgemeine Bearbeitung	✦ : Instabile Bearbeitung				
Form	Bestellbezeichnung	PKD	Abmessungen (mm)					Abbildung	Zugehöriger Halter Seite	
		MD220	IC	S	RE	LE	D1			
<b>PKD</b> <b>B</b> (Mit Spanbrecher)	NP-AUSFÜHRUNG	NP-VNMM160402R-F	★	9.525	4.76	0.2	2.5	3.81		C019 -021 E017
		NP-VNMM160404R-F	★	9.525	4.76	0.4	2.5	3.81		
		NP-VNMM160408R-F	★	9.525	4.76	0.8	2.0	3.81		
	VNGA160404	VNGA160404	★	9.525	4.76	0.4	2.6	3.81		C019 -021 E017
	VNGA160408	VNGA160408	★	9.525	4.76	0.8	1.8	3.81		

PKD-WSP FÜR DAS DREHEN

**NEG**

**MIT LOCH**

C

D

R

S

T





V

W

● : Lagerstandard. ★ : Lagerstandard in Japan.

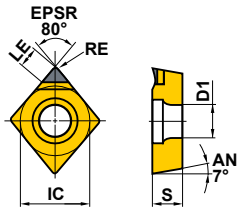

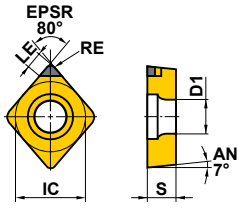
# PKD- WSP FÜR DAS DREHEN [POSITIV]

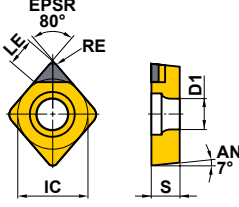
## 80° CC AUSFÜHRUNG WSP MIT LOCH

Werkstoff	N	Nicht-Eisen-Metalle	PKD	Abmessungen (mm)					Abbildung	Zugehöriger Halter Seite
	MD220			IC	S	RE	LE	D1		
 (Mit Spanbrecher)	NP-AUSFÜHRUNG	NP-CCMH060202	★	6.35	2.38	0.2	1.7	2.8		C024 D010 E007 E008 E032 E036
		NP-CCMH060204	★	6.35	2.38	0.4	1.8	2.8		
 (Mit Spanbrecher)	NP-AUSFÜHRUNG	* NP-CCMW03S102	●	3.57	1.39	0.2	1.1	2.0		E018
		* NP-CCMW03S104	★	3.57	1.39	0.4	1.0	2.0		
		* NP-CCMW04T002	●	4.37	1.79	0.2	1.5	2.4		
		* NP-CCMW04T004	★	4.37	1.79	0.4	1.4	2.4		
 (Mit Spanbrecher)		CCMW060202	★	6.35	2.38	0.2	2.9	2.8		C024 D010 E007 E008 E032 E036
		CCMW060204	★	6.35	2.38	0.4	2.9	2.8		
		CCMW09T302	★	9.525	3.97	0.2	3.3	4.4		
		CCMW09T304	★	9.525	3.97	0.4	3.3	4.4		

\* Der Innenkreis der WSP ist eine Sonderausführung. (Für SCLC-Typ)

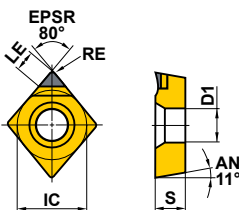
## 80° CP AUSFÜHRUNG WSP MIT LOCH

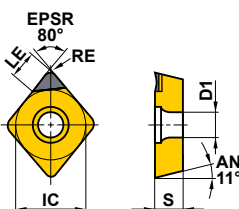
Werkstoff	N	Nicht-Eisen-Metalle	PKD	Abmessungen (mm)					Abbildung	Zugehöriger Halter Seite
	MD220			IC	S	RE	LE	D1		
 (Mit Spanbrecher)	NP-AUSFÜHRUNG	NP-CPMH080202	★	7.94	2.38	0.2	1.7	3.5		E007 E008
		NP-CPMH080204	★	7.94	2.38	0.4	1.8	3.5		
		NP-CPMH090302	★	9.525	3.18	0.2	1.7	4.5		
		NP-CPMH090304	★	9.525	3.18	0.4	1.8	4.5		
 (Mit Spanbrecher)		CPGT080202	★	7.94	2.38	0.2	3.7	3.4		-
		CPGT080204	★	7.94	2.38	0.4	3.6	3.4		
		CPGT090302	★	9.525	3.18	0.2	3.3	4.4		
		CPGT090304	★	9.525	3.18	0.4	3.3	4.4		



# PKD-WSP FÜR DAS DREHEN [POSITIV]

## 55° DC AUSFÜHRUNG WSP MIT LOCH

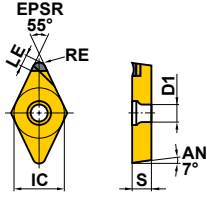
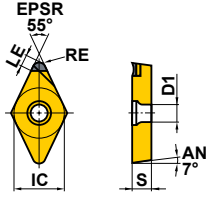

Werkstoff	N	Nicht-Eisen-Metalle	PKD	Abmessungen (mm)					Abbildung	Zugehöriger Halter Seite
				IC	S	RE	LE	D1		
NP-AUSFÜHRUNG  (Mit Spanbrecher)			★	6.35	2.38	0.2	1.4	2.8	 <p>Abbildung zeigt linke WSP.</p>	C025 D011 D026 E010 E011 E031 E033
			★	6.35	2.38	0.2	1.4	2.8		
			★	6.35	2.38	0.4	1.5	2.8		
			★	6.35	2.38	0.4	1.5	2.8		
			★	9.525	3.97	0.2	1.4	4.4		
			★	9.525	3.97	0.2	1.4	4.4		
			★	9.525	3.97	0.4	1.5	4.4		
			★	9.525	3.97	0.4	1.5	4.4		
			★	6.35	2.38	0.2	2.7	2.8		
			★	6.35	2.38	0.4	2.5	2.8		
		★	9.525	3.97	0.2	3.0	4.4		C025 D011 D026 E010 E011 E031 E033	
		★	9.525	3.97	0.4	2.9	4.4			

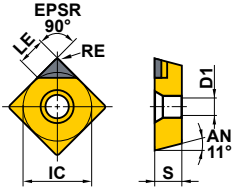
## 90° SP AUSFÜHRUNG WSP MIT LOCH

Werkstoff	N	Nicht-Eisen-Metalle	PKD	Abmessungen (mm)					Abbildung	Zugehöriger Halter Seite
				IC	S	RE	LE	D1		
(Mit Spanbrecher)			★	9.525	3.18	0.4	3.7	4.8		-
			★	9.525	3.18	0.8	3.8	4.8		

★ : Lagerstandard in Japan.

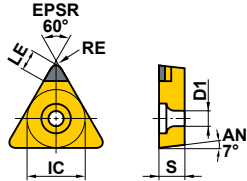
# 60° TC AUSFÜHRUNG WSP MIT LOCH

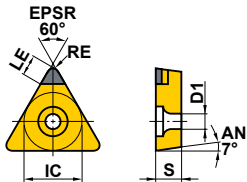
Werkstoff	N	Nicht-Eisen-Metalle	●	Schnittbedingungen :					
				● : Stabile Bearbeitung	● : Allgemeine Bearbeitung	✦ : Instabile Bearbeitung			
Form	Bestellbezeichnung	PKD	Abmessungen (mm)					Abbildung	Zugehöriger Halter Seite
		MD220	IC	S	RE	LE	D1		
	TCMW110202	★	6.35	2.38	0.2	2.7	2.8		C029 E030
	TCMW110204	★	6.35	2.38	0.4	2.6	2.8		
	TCGW060102	★	3.97	1.59	0.2	1.5	2.3		-
	TCGW060104	★	3.97	1.59	0.4	1.6	2.3		
	TCGW060108	★	3.97	1.59	0.8	1.4	2.3		

PKD

B

PKD-WSP FÜR DAS DREHEN

POSI  
7°

MIT  
LOCH

C

D

R

S

T

V

W

# PKD-WSP FÜR DAS DREHEN [POSITIV]

## 60° TP AUSFÜHRUNG WSP MIT LOCH

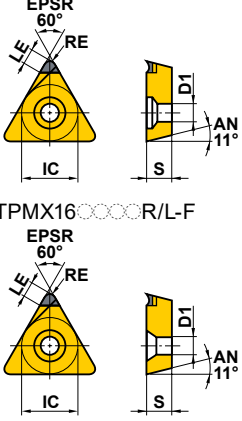
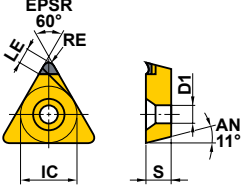
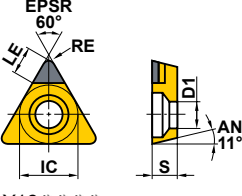
Werkstoff	N	Nicht-Eisen-Metalle	PKD	Schnittbedingungen :					Abbildung	Zugehöriger Halter Seite
				● : Stabile Bearbeitung	● : Allgemeine Bearbeitung	✦ : Instabile Bearbeitung				
Form	Bestellbezeichnung	MD220	IC	S	RE	LE	D1			
<b>PKD</b>  <b>B</b>  PKD-WSP FÜR DAS DREHEN  POSI 11° MIT LOCH  C  D  R  S  T  V  W	NP-AUSFÜHRUNG									
	NP-TPMX090202R-F	★	5.56	2.38	0.2	1.5	3.0	 <p>NP-TPMX160302L-F</p>	E009 E027	
	NP-TPMX090202L-F	★	5.56	2.38	0.2	1.5	3.0			
	NP-TPMX090204L-F	★	5.56	2.38	0.4	1.6	3.0			
	NP-TPMX090208L-F	★	5.56	2.38	0.8	1.7	3.0			
	NP-TPMX110302L-F	★	6.35	3.18	0.2	1.5	3.5			
	NP-TPMX110304L-F	★	6.35	3.18	0.4	1.6	3.5			
	NP-TPMX110308L-F	★	6.35	3.18	0.8	1.7	3.5			
	NP-TPMX160302L-F	★	9.525	3.18	0.2	1.5	4.8			
	NP-TPMX160304L-F	★	9.525	3.18	0.4	1.6	4.8			
NP-TPMX160308L-F	★	9.525	3.18	0.8	1.7	4.8				
(Mit Spanbrecher)								Abbildung zeigt rechte WSP.		
NP-AUSFÜHRUNG										
NP-TPMH080202R-F	★	4.76	2.38	0.2	1.5	2.4		E009		
NP-TPMH080202L-F	★	4.76	2.38	0.2	1.5	2.4				
NP-TPMH080204R-F	★	4.76	2.38	0.4	1.6	2.4				
NP-TPMH080204L-F	★	4.76	2.38	0.4	1.6	2.4				
NP-TPMH090202R-F	★	5.56	2.38	0.2	1.5	2.9				
NP-TPMH090202L-F	★	5.56	2.38	0.2	1.5	2.9				
NP-TPMH090204R-F	★	5.56	2.38	0.4	1.6	2.9				
NP-TPMH090204L-F	★	5.56	2.38	0.4	1.6	2.9				
NP-TPMH110302R-F	★	6.35	3.18	0.2	1.5	3.4				
NP-TPMH110302L-F	★	6.35	3.18	0.2	1.5	3.4				
NP-TPMH110304R-F	★	6.35	3.18	0.4	1.6	3.4				
NP-TPMH110304L-F	★	6.35	3.18	0.4	1.6	3.4				
NP-TPMH160302R-F	★	9.525	3.18	0.2	1.5	4.4				
NP-TPMH160302L-F	★	9.525	3.18	0.2	1.5	4.4				
NP-TPMH160304R-F	★	9.525	3.18	0.4	1.6	4.4				
(Mit Spanbrecher)								Abbildung zeigt linke WSP.		
TPGX080202	★	4.76	2.38	0.2	1.8	2.5		E009 E027		
TPGX080204	★	4.76	2.38	0.4	1.7	2.5				
TPGX080208	★	4.76	2.38	0.8	1.4	2.5				
TPGX090202	★	5.56	2.38	0.2	2.7	3.0				
TPGX090204	★	5.56	2.38	0.4	2.6	3.0				
TPGX090208	★	5.56	2.38	0.8	2.3	3.0				
TPGX110302	★	6.35	3.18	0.2	2.7	3.5				
TPGX110304	★	6.35	3.18	0.4	2.6	3.5				
TPGX110308	★	6.35	3.18	0.8	2.3	3.5				
TPGX160304	★	9.525	3.18	0.4	2.9	4.8				
TPGX160308	★	9.525	3.18	0.8	2.6	4.8				

★ : Lagerstandard in Japan.

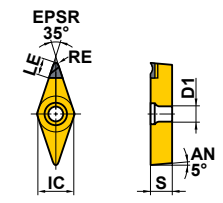

# 35° VB AUSFÜHRUNG WSP MIT LOCH

Werkstoff	N	Nicht-Eisen-Metalle	●	Schnittbedingungen :				PKD	Abmessungen (mm)					Abbildung	Zugehöriger Halter Seite
				● : Stabile Bearbeitung	● : Allgemeine Bearbeitung	✦ : Instabile Bearbeitung	IC		S	RE	LE	D1			
NP-AUSFÜHRUNG    (Mit Spanbrecher)			★	6.35	3.18	0.1	2.5	2.85		D010 D011 E013 E014					
			★	6.35	3.18	0.2	2.5	2.85							
			★	6.35	3.18	0.4	2.5	2.85							
			★	6.35	3.18	0.05	2.5	2.85							

PKD

B

PKD-WSP FÜR DAS DREHEN

POSI  
5°  
7°

MIT  
LOCH

C

D

R

S



T

V

W

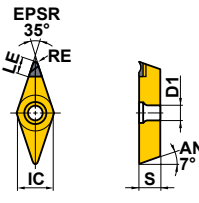

# 35° VC AUSFÜHRUNG WSP MIT LOCH

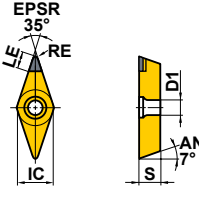
Werkstoff	N	Nicht-Eisen-Metalle	●	Schnittbedingungen :				PKD	Abmessungen (mm)					Abbildung	Zugehöriger Halter Seite
				● : Stabile Bearbeitung	● : Allgemeine Bearbeitung	✦ : Instabile Bearbeitung	IC		S	RE	LE	D1			
NP-AUSFÜHRUNG    (Mit Spanbrecher)			★	4.76	2.38	0.1	2.5	2.4		C030 C031 D013 E014 E034					
			★	4.76	2.38	0.2	2.5	2.4							
			★	4.76	2.38	0.4	2.5	2.4							
			★	4.76	2.38	0.05	2.5	2.4							
			★	6.35	3.18	0.1	2.5	2.8							
			★	6.35	3.18	0.2	2.5	2.8							
			★	6.35	3.18	0.4	2.5	2.8							
NEW  			★	6.35	3.18	0.1	3.1	2.8		C030 D013 E034					
			★	6.35	3.18	0.2	3.0	2.8							
			★	6.35	3.18	0.4	2.6	2.8							

★ = NEW

SORTEN > B028  
IDENTIFIKATION > B002

B071

# PKD-WSP FÜR DAS DREHEN [POSITIV]

## 80° WC AUSFÜHRUNG WSP MIT LOCH

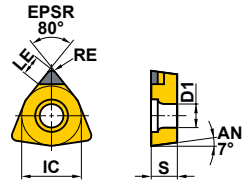
Werkstoff	N	Nicht-Eisen-Metalle	PKD	Abmessungen (mm)					Abbildung	Zugehöriger Halter Seite
				IC	S	RE	LE	D1		
			★	9.525	3.97	0.4	3.0	4.4		E029

PKD

B

PKD-WSP FÜR DAS DREHEN

POSJ  
7°  
11°  
MIT  
LOCH

C

D

R

S

T

V

W

## 80° WP AUSFÜHRUNG WSP MIT LOCH

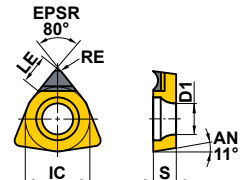
Werkstoff	N	Nicht-Eisen-Metalle	PKD	Abmessungen (mm)					Abbildung	Zugehöriger Halter Seite
				IC	S	RE	LE	D1		
 (Mit Spanbrecher)			★	6.35	2.38	0.2	2.9	2.8		E012
			★	6.35	2.38	0.4	2.9	2.8		
			★	9.525	3.18	0.2	3.3	4.4		
			★	9.525	3.18	0.4	3.3	4.4		

★ : Lagerstandard in Japan.

# 55° DE AUSFÜHRUNG WSP MIT LOCH

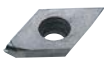
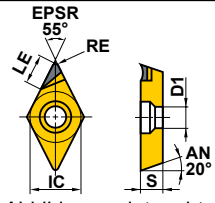
Werkstoff	N	Nicht-Eisen-Metalle	●	Schnittbedingungen :					
				● : Stabile Bearbeitung	● : Allgemeine Bearbeitung	✦ : Instabile Bearbeitung			
Form	Bestellbezeichnung	PKD	Abmessungen (mm)					Abbildung	Zugehöriger Halter Seite
		MD220	IC	S	RE	LE	D1		
	DEGX150404R-F	★	12.7	4.76	0.4	2.9	5.1	 <p>Abbildung zeigt rechte WSP.</p>	C033
	DEGX150404L-F	★	12.7	4.76	0.4	2.9	5.1		
(Mit Spanbrecher)									

PKD

B

PKD-WSP FÜR DAS DREHEN

POSI 20°

MIT LOCH

C

D

R



S

T

V

W

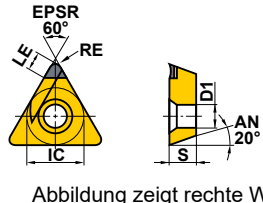
# 60° TE AUSFÜHRUNG WSP MIT LOCH

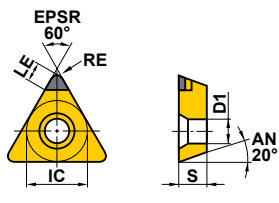
Werkstoff	N	Nicht-Eisen-Metalle	●	Schnittbedingungen :					
				● : Stabile Bearbeitung	● : Allgemeine Bearbeitung	✦ : Instabile Bearbeitung			
Form	Bestellbezeichnung	PKD	Abmessungen (mm)					Abbildung	Zugehöriger Halter Seite
		MD220	IC	S	RE	LE	D1		
	TEGX160302R	★	9.525	3.18	0.2	3.8	4.4	 <p>Abbildung zeigt rechte WSP.</p>	C035 E041
	TEGX160302L	★	9.525	3.18	0.2	3.8	4.4		
	TEGX160304R	★	9.525	3.18	0.4	3.6	4.4		
	TEGX160304L	★	9.525	3.18	0.4	3.6	4.4		
(Mit Spanbrecher)									
	TEGX160302	★	9.525	3.18	0.2	3.1	4.4		C035 E041
	TEGX160304	★	9.525	3.18	0.4	2.9	4.4		

SORTEN > B028

IDENTIFIKATION > B002

B073

# PKD-WSP FÜR DAS DREHEN [POSITIV]

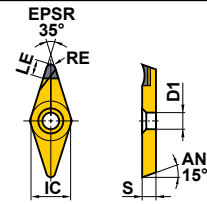

## 35° VDAUSFÜHRUNG WSP MIT LOCH

Werkstoff	N	Nicht-Eisen-Metalle	●	Schnittbedingungen :					Abbildung	Zugehöriger Halter Seite
				● : Stabile Bearbeitung	● : Allgemeine Bearbeitung	✦ : Instabile Bearbeitung				
Form	Bestellbezeichnung	PKD	Abmessungen (mm)					Abbildung	Zugehöriger Halter Seite	
		MD220	IC	S	RE	LE	D1			
 (Mit Spanbrecher)	VDGX160302R-F	●	9.525	3.18	0.2	3.1	4.5	 Abbildung zeigt rechte WSP.	C035	
	VDGX160304R-F	●	9.525	3.18	0.4	2.7	4.5			

PKD

B

PKD-WSP FÜR DAS DREHEN

POSITIV  
15°

MIT  
LOCH

C

D

R

S

T

V

W

● : Lagerstandard. ★ : Lagerstandard in Japan.

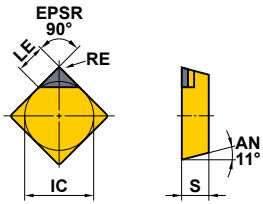

# 90° SP AUSFÜHRUNG WSP OHNE LOCH

Werkstoff	N	Nicht-Eisen-Metalle	●	Schnittbedingungen :				
				● : Stabile Bearbeitung	● : Allgemeine Bearbeitung	✦ : Instabile Bearbeitung		
Form	Bestellbezeichnung	PKD	Abmessungen (mm)				Abbildung	Zugehöriger Halter Seite
		MD220	IC	S	RE	LE		
	SPGN090302	★	9.525	3.18	0.2	3.7		-
	SPGN090304	★	9.525	3.18	0.4	3.7		
	SPGN090308	★	9.525	3.18	0.8	3.8		
	SPGN120304	★	12.7	3.18	0.4	3.7		
	SPGN120308	★	12.7	3.18	0.8	3.8		
	SPGN120312	★	12.7	3.18	1.2	3.7		

PKD

B

PKD-WSP FÜR DAS DREHEN

POSI 11°

OHNE LOCH

C

D

R

S

T

V

W

# 60° TP AUSFÜHRUNG WSP OHNE LOCH

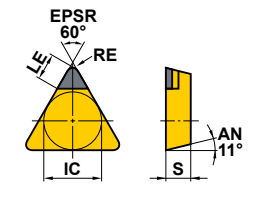
Werkstoff	N	Nicht-Eisen-Metalle	●	Schnittbedingungen :				
				● : Stabile Bearbeitung	● : Allgemeine Bearbeitung	✦ : Instabile Bearbeitung		
Form	Bestellbezeichnung	PKD	Abmessungen (mm)				Abbildung	Zugehöriger Halter Seite
		MD220	IC	S	RE	LE		
	TPGN110302	★	6.35	3.18	0.2	2.7		E028
	TPGN110304	★	6.35	3.18	0.4	2.6		
	TPGN110308	★	6.35	3.18	0.8	2.3		
	TPGN160302	★	9.525	3.18	0.2	3.1		
	TPGN160304	★	9.525	3.18	0.4	2.9		
	TPGN160308	★	9.525	3.18	0.8	2.6		

SORTEN > B028

IDENTIFIKATION > B002

B075

# Notizen

---

A series of horizontal dashed lines for taking notes, spanning the width of the page.

# Notizen

---

A series of horizontal dashed lines for writing notes, spanning the width of the page.

# ALLGEMEINE ERKLÄRUNG: DREHWERKZEUGE

● Wie sind die Seiten dieses Kapitels aufgebaut

① Aufgelistet nach der Form der Drehwendeplatte.  
(Beachten Sie das Inhaltsverzeichnis auf der nächsten Seite.)

**AUSFÜHRUNG DES DREHHALTERS**  
Die ersten vier Buchstaben der Bestellbezeichnung, sowie der Anwendungsbereich werden aufgelistet.

**PRODUKTBEZEICHNUNG IN BEZUG AUF DIE WSP-AUSFÜHRUNG**

**PRODUKT KAPITEL**

**ABBILDUNG ZEIGT DEN ANWENDUNGSBEREICH**  
Verwenden Sie die Abbildungen mit den Bearbeitungsrichtungen als Entscheidungshilfe für Ihren Anwendungsbereich.

**ABBILDUNG**

**SPANBRECHER ÜBERSICHT**

**DREHEN**  
**VN** WSP DREHHALTER

**DVNN** Außen-, Kopierdrehen **DOPPELKLEMM** Ausführung

Bestellbezeichnung	Lager	WSP Bezeichnung	Abmessungen (mm)				Unterplatte	Control	Verriegelungs- schlüssel	Spannschraube	Schlüssel				
			H	B	LF	LH	HF	WF							
DVNN2020K16	●	VN A VN G VN M	1604	20	20	125	44	20	10	DCSWZ BSWZ	LLP13 LLP13	DKK113 DKK113	DCS2 DCS2	DO020T DO020T	TKY15F TKY15F
DVNN2525M16	●	VN A VN G VN M	1604	25	25	150	44	25	12,5	DCSWZ BSWZ	LLP13 LLP13	DKK113 DKK113	DCS2 DCS2	DO020T DO020T	TKY15F TKY15F

\* Spannmoment (N·m) : DO020T13.5

**DVPN** Außen-, Kopierdrehen **DOPPELKLEMM** Ausführung

Bestellbezeichnung	Lager	WSP Bezeichnung	Abmessungen (mm)				Unterplatte	Control	Verriegelungs- schlüssel	Spannschraube	Schlüssel				
			H	B	LF	LH	HF	WF							
DVPNRL2020K16	●	VN A VN G VN M	1604	20	20	125	32	20	25	DCSWZ BSWZ	LLP13 LLP13	DKK113 DKK113	DCS2 DCS2	DO020T DO020T	TKY15F TKY15F
DVPNRL2525M16	●	VN A VN G VN M	1604	25	25	150	32	25	32	DCSWZ BSWZ	LLP13 LLP13	DKK113 DKK113	DCS2 DCS2	DO020T DO020T	TKY15F TKY15F

\* Spannmoment (N·m) : DO020T13.5

**PVNN** Außen-, Kopierdrehen **MP** Ausführung

Bestellbezeichnung	Lager	WSP Bezeichnung	Abmessungen (mm)				Unterplatte	Control	Verriegelungs- schlüssel	Anschlag	Schlüssel		
			H	B	LF	LH	HF	WF					
PVNN2020K16	●	VN A VN G VN M	1604	20	20	125	38	20	10	PV322 (PV321)	P11S	HSP05008C E03	HKY25R HKY25R
PVNN2525M16	●	VN A VN G VN M	1604	25	25	150	38	25	12,5	PV322 (PV321)	P11S	HSP05008C E03	HKY25R HKY25R

\*1 Spannmoment (N·m) : HSP05008C=2,5  
\*2 Bitte folgende Unterlegplatten: PV321 und PV323 bei Wendeschneidplatten mit größerem RE 0,4 mm und RE 1,2 mm verwenden. Spannschlüssel HKY25R, HKY30R für Befestigungsfeder, Spannschlüssel HKY40R für Spannschraube

**PVPN** Außen-, Kopierdrehen **MP** Ausführung

Bestellbezeichnung	Lager	WSP Bezeichnung	Abmessungen (mm)				Unterplatte	Control	Verriegelungs- schlüssel	Anschlag	Schlüssel		
			H	B	LF	LH	HF	WF					
PVPNRL2020K16	●	VN A VN G VN M	1604	20	20	125	32	20	25	PV322 (PV321)	P11S	HSP05008C E03	HKY25R HKY25R
PVPNRL2525M16	●	VN A VN G VN M	1604	25	25	150	32	25	32	PV322 (PV321)	P11S	HSP05008C E03	HKY25R HKY25R

\*1 Spannmoment (N·m) : HSP05008C=2,5  
\*2 Bitte folgende Unterlegplatten: PV321 und PV323 bei Wendeschneidplatten mit größerem RE 0,4 mm und RE 1,2 mm verwenden. Bei Verwendung von Wendeschneidplatten sollte die Unterlegplatte separat bestellt werden.

Bemerkung 1) Die Abbildungen der Wendeschneidplatten dienen nur als Beispiel. Die Buchstaben bezeichnen den Spanbrecher, und die Abmessung bezieht sich auf den Innendurchmesser.  
● Lagerstandard.  
\* Lagerstandard in Japan.

**LEGENDE FÜR LAGERSYMBOLS**  
Wird auf jeder Doppelseite auf der linken Seite gezeigt.

**QUERVERWEISE / VERFÜGBARE WSP**  
Weist auf weitere detaillierte Produktinformationen hin.

**STANDARDPRODUKTE**  
Listet Bestellbezeichnung, Lagerstatus (Rechts/Links), Abmessungen, verfügbare WSP und Ersatzteile auf.

**QUERVERWEIS AUF ANDERE SEITEN**  
-ERSATZTEILE  
-TECHNISCHE DATEN  
Beinhaltet Querverweise für alle auf dieser Doppelseite aufgeführten Produkte.

DVNN WSP	> A126 - A129	CBN & PKD WSP	> B046, B047, B066	SCHNITTDATENEMPFERUNG	> A074, B030
DVPN WSP	> A126 - A129	CBN & PKD WSP	> B046, B047, B066	ERSATZTEILE	> N001
PVNN WSP	> A126 - A129	CBN & PKD WSP	> B046, B047, B066	TECHNISCHE DATEN	> P001

DREHEN

# DREHWERKZEUGE





KLASSIFIKATION .....	C002
IDENTIFIKATION .....	C006
SPANNSYSTEM .....	C007
<b>STANDARDHALTER</b>	
CN○○WSP DREHHALTER .....	C008
DN○○WSP DREHHALTER .....	C010
SN○○WSP DREHHALTER .....	C012
TN○○WSP DREHHALTER .....	C016
VN○○WSP DREHHALTER .....	C019
WN○○WSP DREHHALTER .....	C022
CC○○WSP DREHHALTER .....	C024
DC○○WSP DREHHALTER .....	C025
RC○○WSP DREHHALTER .....	C026
SC○○WSP DREHHALTER .....	C028
TC○○WSP DREHHALTER .....	C029
VC○○WSP DREHHALTER .....	C030
XC○○WSP DREHHALTER .....	C032
TL HALTER .....	C037
<b>AL HALTER</b>	
DE○○WSP DREHHALTER .....	C034
TE○○WSP DREHHALTER .....	C035
VD○○WSP DREHHALTER .....	C036



\*Alphabetisches Inhaltsverzeichnis

C008 <b>DCLN</b>	C012 <b>PSBN</b>	C029 <b>STGC</b>
C010 <b>DDJN</b>	C014 <b>PSDN</b>	C035 <b>STGE</b>
C016 <b>DTGN</b>	C015 <b>PSKN</b>	C030 <b>SVJC</b>
C019 <b>DVJN</b>	C013 <b>PSSN</b>	C036 <b>SVJD</b>
C021 <b>DVPN</b>	C013 <b>PSTN</b>	C031 <b>SVPC</b>
C020 <b>DVVN</b>	C017 <b>PTFN</b>	C030 <b>SVVC</b>
C022 <b>DWLN</b>	C016 <b>PTGN</b>	C032 <b>SXZC</b>
C009 <b>MCLN</b>	C019 <b>PVJN</b>	C037 <b>TLHR</b>
C012 <b>MSBN</b>	C021 <b>PVPN</b>	
C014 <b>MSSN</b>	C020 <b>PVVN</b>	
C018 <b>MTEN</b>	C022 <b>PWLN</b>	
C017 <b>MTJN</b>	C024 <b>SCLC</b>	
C018 <b>MTQN</b>	C025 <b>SDJC</b>	
C023 <b>MWLN</b>	C034 <b>SDJE</b>	
C009 <b>PCBN</b>	C025 <b>SDNC</b>	
C008 <b>PCLN</b>	C034 <b>SDNE</b>	
C011 <b>PDHN</b>	C027 <b>SRDC</b>	
C010 <b>PDJN</b>	C027 <b>SRGC</b>	
C026 <b>PRDC</b>	C028 <b>SSSC</b>	
C026 <b>PRGC</b>	C035 <b>STFE</b>	

# KLASSIFIKATION (Negative WSP)

Halterbezeichnung	Eigenschaften Schaftgrößen (H x B x L)	Außendrehen Plandrehen		Außendrehen Kopierdrehen		Außendrehen	
		KAPR=95°	KAPR=93°	KAPR=72.5°	KAPR=91°		
<b>LL Halter</b> 	<ul style="list-style-type: none"> <li>● Kniehebel.</li> <li>● ISO Standard.</li> <li>● Vielfältige Halterausführungen.</li> <li>● Anwendungsbereich von Schlichten bis Schwerzerspannung.</li> <li>● Wirtschaftliche negative WSP.</li> </ul> 10 x 10 x 70   25 x 25 x 150 12 x 12 x 80   32 x 25 x 170 16 x 16 x 100   32 x 32 x 170 20 x 20 x 125						
		<b>PCLN</b> ↻ C008	<b>PWLN</b> ↻ C022	<b>PDJN</b> ↻ C010		<b>PTGN</b> ↻ C016	
<b>DOPPEL KLEMM Halter</b> 	<ul style="list-style-type: none"> <li>● Doppelklemmung.</li> <li>● Sichere WSP-Klemmung.</li> <li>● Präzise Schneidkantenpositionierung.</li> <li>● Wirtschaftliche negative WSP.</li> <li>● Kleine WSP verfügbar.</li> </ul> 16 x 16 x 100   25 x 25 x 150 20 x 20 x 125   32 x 25 x 170						
		<b>DCLN</b> ↻ C008	<b>DWLN</b> ↻ C022	<b>DDJN</b> ↻ C010	<b>DVJN</b> ↻ C019	<b>DVVN</b> ↻ C020	<b>DTGN</b> ↻ C016
<b>DOPPEL KLEMM Halter</b> (Für Schwerzerspannung) 	<ul style="list-style-type: none"> <li>● Doppelklemm Halter.</li> <li>● Sichere WSP-Klemmung.</li> <li>● Geeignet für schwere Zerspanung.</li> <li>● Negative WSP.</li> </ul> 32 x 32 x 170 40 x 40 x 200						
		<b>MCLN</b> ↻ C009					
<b>WP Halter</b> 	<ul style="list-style-type: none"> <li>● Doppelklemm Halter.</li> <li>● Einfacher Plattenwechsel.</li> <li>● Wirtschaftliche negative WSP.</li> </ul> 20 x 20 x 125 25 x 25 x 150 32 x 25 x 170						
		<b>MWLN</b> ↻ C023	<b>MTJN</b> ↻ C017				
<b>MP Halter</b> 	<ul style="list-style-type: none"> <li>● Excenterspannung.</li> <li>● WSP in Rhombus.</li> <li>● Geeignet für Freistriche.</li> </ul> 20 x 20 x 125 25 x 25 x 150						
			<b>PVJN</b> ↻ C019	<b>PVVN</b> ↻ C020			

DREHEN C

	Außendreihen	Außendreihen, Fasen		Außendreihen, Plandreihen, Fasen	Plandreihen		Plandreihen, Kopierdreihen	Außendreihen, Kopierdreihen	Standard Auswahl				
	KAPR=75°	KAPR=60°	KAPR=45°	KAPR=45°	KAPR=75°	KAPR=91°	KAPR=105° 107.5° 117.5°	Spezielles Design (Positive WSP)	Rationell	Geringer Schnittwiderstand (scharf)	Klemmstabilität (WSP)	Leistungsdreihen	Spezialisiert
	PCBN ↻ C009	PSBN ↻ C012	PSTN ↻ C013	PSDN ↻ C014	PSSN ↻ C013	PSKN ↻ C015	PTFN ↻ C017	PDHN ↻ C011	PRGC ↻ C026	PRDC ↻ C026			
							DVPN ↻ C021						
	MSBN ↻ C012			MSSN ↻ C014									
		MTEN ↻ C018					MTQN ↻ C018						
							PVPN ↻ C021						

Hinweis 1) ◎ : 1. Empfehlung ○ : 2. Empfehlung



# KLASSIFIKATION(Positive WSP)

Halterbezeichnung	Eigenschaften Schaftgrößen (H x B x L)	Außendreihen, Plandrehen	Außendreihen, Kopierdrehen					
		KAPR=95°	KAPR=93° 95°	KAPR=62.5° 72.5°				
<b>PROFILHALTER</b>	<ul style="list-style-type: none"> <li>• Doppelklemmhalter.</li> <li>• WSP in Rhombus.</li> <li>• Für das Profildrehen mit bis zu 60° Konturwinkel</li> </ul> 16 x 16 x 100 20 x 20 x 125 25 x 25 x 150							
<b>SP Halter</b>	<ul style="list-style-type: none"> <li>• Schraubenklemmung.</li> <li>• Minihalter mit 7°WSP.</li> </ul> 8 x 8 x 60 10 x 10 x 70 12 x 12 x 80 16 x 16 x 100 20 x 20 x 125 25 x 25 x 150							
<b>AL Halter</b> (Für die Aluminium Bearbeitung)	<ul style="list-style-type: none"> <li>• Schraubenklemmung.</li> <li>• 20° positive WSP.</li> <li>• (35° rhombus WSP 15°)</li> <li>• Großer Spanwinkel, scharfe Schneidkante.</li> </ul> 16 x 16 x 100 20 x 20 x 125 25 x 25 x 150							
<b>TL Halter</b>	<ul style="list-style-type: none"> <li>• Kegelklemmung.</li> <li>• Gute Schlichtoberfläche durch runde Form der WSP.</li> </ul> 20 x 20 x 125 25 x 25 x 150 32 x 25 x 170							
<b>SMALL TOOLS</b>	<ul style="list-style-type: none"> <li>• Schraubenklemmung.</li> <li>• Werkzeuge, die an linearen Werkzeugträgern angebracht werden.</li> <li>• Minihalter mit 7°WSP.</li> </ul> 8 x 8 x 125 10 x 10 x 125 12 x 12 x 150 16 x 16 x 150							
<b>SMALL TOOLS</b>	<ul style="list-style-type: none"> <li>• Schraubenklemmung.</li> <li>• Werkzeuge, die an linearen Werkzeugträgern angebracht werden.</li> <li>• Hohe Stabilität aufgrund von vertikaler Wendeschneidplattenklemmung. (BTA/CTB Ausführung)</li> <li>• Hinterdrehen (BTA/CTB Ausführung)</li> </ul> 8 x 10 x 120 10 x 10 x 120 12 x 12 x 120 16 x 16 x 120							

DREHEN

	Außendreihen	Außendreihen, Plandreihen, Fasen	Plandreihen	Plandreihen, Kopierdrehen	Außendreihen, Kopierdrehen	Standard Auswahl				
	<p><b>KAPR=90° 91°</b></p>	<p><b>KAPR=45°</b></p>	<p><b>KAPR=91°</b></p>	<p><b>KAPR=117.5°</b></p>	<p>Spezielles Design</p>	Rationell	Geringer Schnittwiderstand (scharf)	Klemmstabilität (WSP)	Leistungsdrehen	Spezialisiert
					<p><b>SXZC</b> ↻ C032</p>	○	○			
	<p><b>STGC</b> ↻ C029</p>	<p><b>SSSC</b> ↻ C028</p>		<p><b>SVPC</b> ↻ C031</p>	<p><b>SRGC</b> ↻ C027</p>	○				
	<p><b>STGE</b> ↻ C035</p>		<p><b>STFE</b> ↻ C035</p>			○			○	
					<p><b>TLHR</b> ↻ C037</p>	○			○	
	<p><b>SCAC-SM</b> ↻ D010</p>			<p><b>SVPP-SM</b> ↻ D013</p>		○				
					<p>Spezielles Design</p> <p><b>BTAH/CTBH</b> ↻ D014, D015</p> <p><b>BTVH</b> ↻ D016</p>	○				

Hinweis 1) ○ : 1. Empfehlung ○ : 2. Empfehlung

# IDENTIFIKATION

■ LL Halter / DOPPELKLEMMHALTER /  
SP Halter / PROFILHALTER / AL Halter

**P** **C** **L** **N** **R** **25** **25** **M** **12**

① WSP Spannung

D	Doppelklemmausführung
M	Mehrfachklemmung Mit seitlicher Anlegeplatte
P	Kniehebel
S	Schraubenklemmung

③ Schneidwinkel KAPR

A	90° Nicht abgesetzt
B	75°
D	45° Neutral
E	60°
F	90°
G	90° Abgesetzt
H	107.5°
J	93°
K	75°
L	95°
N	62.5°
P	117.5°
Q	105°
S	45°
T	60°
V	72.5°
Z	Sonder

④ WSP Freiwinkel

C	7° Positiv
N	Negativ
E	20° Positiv

⑤ Bearbeitungsrichtung

R	Rechtsausführung
L	Linksausführung
N	Neutral

⑥ Schaftquerschnitt H/B (mm)  
(Höhe und Breite)

8	08
10	10
12	12
16	16
20	20
25	25
32	32

⑦ Werkzeuglänge LF (mm)

D	60
E	70
F	80
H	100
K	125
M	150
P	170
Q	180
R	200

⑧ Schneidkantenlänge (mm)

Innenmessdurchmesser	WSP Form					
	Vierkant	Dreikant	Rund	Rhombus 80°	Rhombus 55°	Rhombus 35°
6.00	-	-	06	-	-	-
6.35	-	11	-	06	07	11
7.94	-	13	-	-	-	-
8.00	-	-	08	-	-	-
9.525	09	16	-	09	11	16
10.00	-	-	10	-	-	-
12.00	-	-	12	-	-	-
12.70	12	22	-	12	15	-
15.875	15	27	-	16	-	-
16.00	-	-	16	-	-	-
19.05	19	-	-	19	-	-
20.00	-	-	20	-	-	-
25.00	-	-	25	-	-	-
25.40	25	-	-	-	-	-
32.00	-	-	32	-	-	-

② Wendeplattenform

C	Rhomboid 80°
D	Rhomboid 55°
R	Rund
S	Vierkant
T	Dreikant
V	Rhomboid 35°
W	Sechskant
X	Spezielles Design

# SPANNSYSTEM

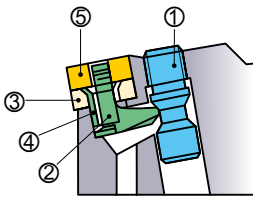
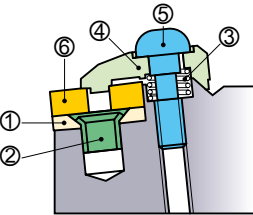
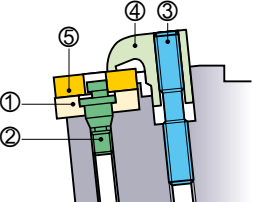
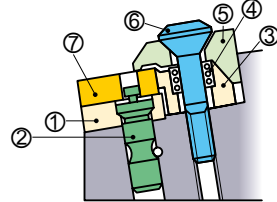
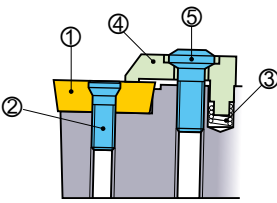
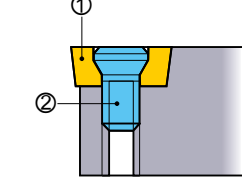
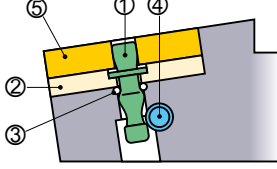
Variante (Halter)	Aufbau	
<b>Kniehebelklemmung (LL HALTER)</b>		<ul style="list-style-type: none"> <li>① Spannschraube</li> <li>② Kniehebel</li> <li>③ Unterlegplatte</li> <li>④ Befestigungsfeder</li> <li>⑤ Wendeplatte</li> </ul>
<b>Doppelklemmung (DOPPELKLEMM) HALTER</b>		<ul style="list-style-type: none"> <li>① Unterlegplatte</li> <li>② Befestigungsfeder</li> <li>③ Feder</li> <li>④ Spannfinger</li> <li>⑤ Spannschraube</li> <li>⑥ Wendeplatte</li> </ul>
<b>Mehrfachklemmung (DOPPELKLEMM) HALTER</b> (Für Schwerzerspannung)		<ul style="list-style-type: none"> <li>① Unterlegplatte</li> <li>② Befestigungsfeder</li> <li>③ Spannschraube</li> <li>④ Spannfinger</li> <li>⑤ Wendeplatte</li> </ul>
<b>Mehrfachklemmung (Mit seitlicher Anlegeplatte) (WP HALTER)</b>		<ul style="list-style-type: none"> <li>① Unterlegplatte</li> <li>② Befestigungsfeder</li> <li>③ Seitl. Anlegeplatte</li> <li>④ Feder</li> <li>⑤ Spannfinger</li> <li>⑥ Spannschraube</li> <li>⑦ Wendeplatte</li> </ul>
<b>Doppelt wirkende Zweifachklemme (PROFILHALTER)</b>		<ul style="list-style-type: none"> <li>① Wendeplatte</li> <li>② Spannschraube (1)</li> <li>③ Feder</li> <li>④ Spannfinger</li> <li>⑤ Spannschraube (2)</li> </ul>
<b>Schraubklemmung (SP HALTER) (AL HALTER)</b>		<ul style="list-style-type: none"> <li>① Wendeplatte</li> <li>② Spannschraube</li> </ul>
<b>Exzenterspannung (MP HALTER)</b>		<ul style="list-style-type: none"> <li>① Exzenterstift</li> <li>② Unterlegplatte</li> <li>③ Anschlagring</li> <li>④ Verriegelungsschraube</li> <li>⑤ Wendeplatte</li> </ul>

DREHEN

# DREHEN





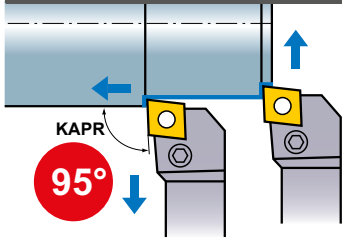

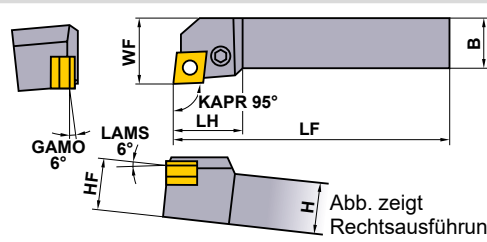

## CN WSP DREHHALTER





### PCLN



### Längs-, Plandrehen LL Ausführung



Schichten	Leicht	Mittel	Mittel
FP  (12)	LP  (12)	MP  (12,16,19)	MK  (12,16,19)
Mittel	Mittlere bis Schruppen	Rostfrei	CBN
Standard  (09,12,16,19)	RP  (12,16,19)	MM  (12,16,19)	 (12)

Bestellbezeichnung	Lager		WSP Bezeichnung	Abmessungen (mm)											
	R	L		H	B	LF	LH	HF	WF	Unterlegplatte	Befestigungsfeder	Kniehebel	Spannschraube	Schlüssel	
PCLNR/L1616H09	●	●	CNMG	09T3	16	16	100	22	16	20	LLSCN3T3	LLP13	LLCL13	LLCS106	HKY25R
PCLNR/L2020K09	●	●		09T3	20	20	125	22	20	25	LLSCN3T3	LLP13	LLCL13	LLCS106	HKY25R
PCLNR/L2525M09	●	●		09T3	25	25	150	22	25	32	LLSCN3T3	LLP13	LLCL13	LLCS106	HKY25R
PCLNR/L2020K12	●	●	CNMA CNMG CNMM CNGA CNGG CNGM	1204	20	20	125	28	20	25	LLSCN42	LLP14	LLCL14	LLCS108	HKY30R
PCLNR/L2525M12	●	●		1204	25	25	150	28	25	32	LLSCN42	LLP14	LLCL14	LLCS108	HKY30R
PCLNR/L3225P12	●	●		1204	32	25	170	28	32	32	LLSCN42	LLP14	LLCL14	LLCS108	HKY30R
PCLNR/L3232P16	●	●		1606	32	32	170	32	32	40	LLSCN53	LLP15	LLCL25	LLCS508	HKY30R
PCLNR/L3232P19	●	●		1906	32	32	170	40	32	40	LLSCN63	LLP16	LLCL16	LLCS310	HKY40R

\* Spannmoment (N • m) : LLCS106=2.2, LLCS108=3.3, LLCS508=3.3, LLCS310=7.0



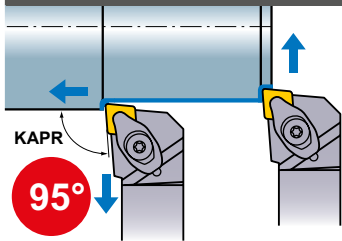

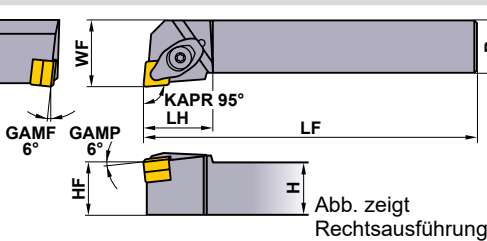

### DCLN



### Außendrehen, Plandrehen DOPPELKLEMM-Ausführung



Schichten	Leicht	Mittel	Mittel
FP  (12)	LP  (12)	MP  (12)	MK  (12)
Mittel	Mittlere bis Schruppen	Rostfrei	CBN
Standard  (09,12)	RP  (12)	MM  (12)	 (12)

Bestellbezeichnung	Lager		WSP Bezeichnung	Abmessungen (mm)												
	R	L		H	B	LF	LH	HF	WF	Unterlegplatte	Befestigungsfeder	Spannfinger	Feder	Spannschraube	Schlüssel	
DCLNR/L1616H09	●	●	CNMG	09T3	16	16	100	25	16	20	LLSCN3T3 (LLSCN33)	LLP23	DCK2211	DCS2	DC0520T	TKY15F
DCLNR/L1616H09-T	●	●		0903	16	16	100	25	16	20	LLSCN33	LLP23	DCK2211	DCS2	DC0520T	TKY15F
DCLNR/L2020K09	●	●		09T3	20	20	125	25	20	25	LLSCN3T3 (LLSCN33)	LLP23	DCK2211	DCS2	DC0520T	TKY15F
DCLNR/L2020K09-T	●	●		0903	20	20	125	25	20	25	LLSCN33	LLP23	DCK2211	DCS2	DC0520T	TKY15F
DCLNR/L2525M09	●	●		09T3	25	25	150	25	25	32	LLSCN3T3 (LLSCN33)	LLP23	DCK2211	DCS2	DC0520T	TKY15F
DCLNR/L2525M09-T	●	●		0903	25	25	150	25	25	32	LLSCN33	LLP23	DCK2211	DCS2	DC0520T	TKY15F
DCLNR/L2020K12	●	●	CNMA CNMG CNMM CNGA CNGG CNGM	1204	20	20	125	29	20	25	LLSCN42	LLP14	DCK2613	DCS1	DC0621T	TKY20F
DCLNR/L2525M12	●	●		1204	25	25	150	29	25	32	LLSCN42	LLP14	DCK2613	DCS1	DC0621T	TKY20F
DCLNR/L3225P12	●	●		1204	32	25	170	29	32	32	LLSCN42	LLP14	DCK2613	DCS1	DC0621T	TKY20F

\*1 Spannmoment (N • m) : DC0520T=3.5, DC0621T=5.0

\*2 Beim Einsatz von 3.18mm dicken WSP muss die Unterlegplatte LLSCN33 verwendet werden. Die Unterlegplatte für 3.18mm dicke WSP muss separat bestellt werden.

Hinweis 1) Die Abbildungen der Wendeschneidplatten dienen nur als Beispiel. Die Buchstaben bezeichnen den Spanbrecher und die Abmessung bezieht sich auf den Innenkreisdurchmesser.

● : Lagerstandard.

PCLN WSP > A098–A104  
DCLN WSP > A098–A104

PCBN & PKD WSP > B036–B038, B064  
SCHNITTDATENEMPFEHLUNGEN > A074, B020

MCLN		Außendrehen, Plandrehen		DOPPELKLEMM Ausführung Für Schwerzerspannung							Mittel		Mittlere bis Schruppen		
											MH	Standard	MS	RP	
				 (19)		 (19)		 (19)		 (19)					
				Schwerzerspannung		Schwerzerspannung		Schwerzerspannung		Mittel					
				 (19)		 (19)		 (19)		 (19)					
				Schwerzerspannung		Schwerzerspannung		Schwerzerspannung		Mittel					
Bestellbezeichnung	Lager	WSP Bezeichnung		Abmessungen (mm)											
	R			H	B	LF	LH	HF	WF	Unterlegplatte	Befestigungsfeder	Spannfinger	Spannschraube*	Schlüssel	
MCLNR3232P19	●	CNMG	1906	32	32	170	36	32	40	MSCN63	MP6	CKW6	LS25	HKY40R	
MCLNR4040R19	●	CNMM CNMA	1906	40	40	200	36	40	50	MSCN63	MP6	CKW6	LS25	HKY40R	

\* Spannmoment (N • m) : LS25=8.2

PCBN		Außendrehen		LL Ausführung							Schichten		Leicht		Mittel		Mittel	
											FP	LP	MP	MK				
				 (12)		 (12)		 (12)		 (12)								
				Mittel		Mittlere bis Schruppen		Rostfrei										
				 (12)		 (12)		 (12)										
				Standard		RP		MM										
Bestellbezeichnung	Lager	WSP Bezeichnung		Abmessungen (mm)														
	R L			H	B	LF	LH	HF	WF	Unterlegplatte	Befestigungsfeder	Kniehebel	Spannschraube*	Schlüssel				
PCBNR/L2020K12	● ●	CN A CN G	1204	20	20	125	28	20	17	LLSCN42	LLP14	LLCL14	LLCS108	HKY30R				
PCBNR/L2525M12	● ●	CN M	1204	25	25	150	25	25	22	LLSCN42	LLP14	LLCL14	LLCS108	HKY30R				

\* Spannmoment (N • m) : LLCS108=3.3

MCLN WSP > A100 – A104  
 PCBN WSP > A098 – A104  
 PCBN & PKD WSP > B036 – B038, B064

SCHNITTDATENEMPFEHLUNGEN > A074, B020  
 ERSATZTEILE > N001  
 TECHNISCHE DATEN > P001

## PDJN

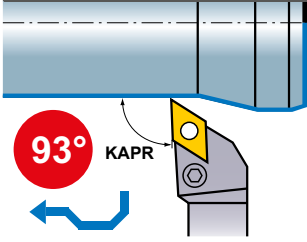

### Außendrehen, Kopierdrehen **LL Ausführung**

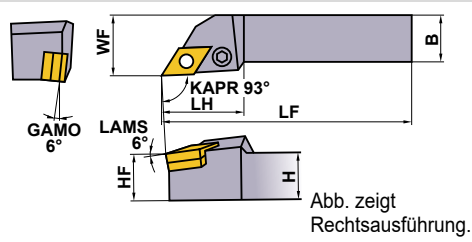









Schichten	Leicht	Mittel	Mittel
FP	LP	MP	MK
 (15)	 (15)	 (15)	 (15)
Mittlere bis Schruppen	Rostfrei	G-Toleranz	CBN
RP	MM	R/L	
 (15)	 (15)	 (15)	 (15)

Abb. zeigt Rechtsausführung.

Bestellbezeichnung	Lager		WSP Bezeichnung	Abmessungen (mm)							*2				*1	
	R	L		H	B	LF	LH	HF	WF	Unterlegplatte	Befestigungsfeder	Kniehebel	Spannschraube	Schlüssel		
PDJNR/L2020K15	●	●	DNMA DNMG DNMM DNMX DNGA DNGG DNMG	1504	20	20	125	35	20	25	LLSDN43 (LLSDN42)	LLP14	LLCL24	LLCS108	HKY30R	
PDJNR/L2525M15	●	●		1504	25	25	150	35	25	32	LLSDN43 (LLSDN42)	LLP14	LLCL24	LLCS108	HKY30R	
PDJNR/L3225P15	●	●		1504	32	25	170	35	32	32	LLSDN43 (LLSDN42)	LLP14	LLCL24	LLCS108	HKY30R	

\*1 Spannungmoment (N · m) : LLCS108=3.3

\*2 Beim Einsatz von 6.35mm dicken WSP muss die Unterlegplatte LLSDN42 verwendet werden. Die Unterlegplatte für 6.35mm dicke WSP muss separat bestellt werden.

DREHEN

## DDJN

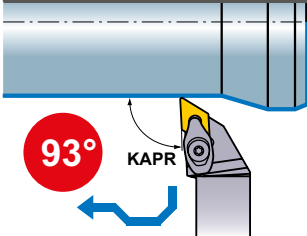

### Außendrehen, Kopierdrehen **DOPPELKLEMM-Ausführung**

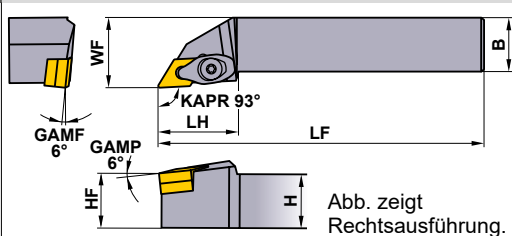

Schichten	Leicht	Mittel	Mittel
FP	LP	MP	MK
 (15)	 (11,15)	 (15)	 (11,15)
Mittlere bis Schruppen	Rostfrei	G-Toleranz	CBN
RP	MM	R/L	
 (15)	 (15)	 (15)	 (15)

Abb. zeigt Rechtsausführung.

Bestellbezeichnung	Lager		WSP Bezeichnung	Abmessungen (mm)							*2				*1	
	R	L		H	B	LF	LH	HF	WF	Unterlegplatte	Befestigungsfeder	Spannfinger	Feder	Spannschraube	Schlüssel	
DDJNR/L1616H11	●	●	DNMG DNGA	1104	16	16	100	28	16	20	LLSDN32	LLP23	DCK2211	DCS2	DC0520T	TKY15F
DDJNR/L2020K11	●	●		1104	20	20	125	28	20	25	LLSDN32	LLP23	DCK2211	DCS2	DC0520T	TKY15F
DDJNR/L2525M11	●	●		1104	25	25	150	28	25	32	LLSDN32	LLP23	DCK2211	DCS2	DC0520T	TKY15F
DDJNR/L3225P11	●	●		1104	32	25	170	28	32	32	LLSDN32	LLP23	DCK2211	DCS2	DC0520T	TKY15F
DDJNR/L2020K15	●	●	DNMA DNMG DNMM DNMX DNGA DNGG DNMG	1504	20	20	125	37	20	25	LLSDN43 (LLSDN42)	LLP24	DCK2613	DCS1	DC0621T	TKY20F
DDJNR/L2020K15-T	●	●		1506	20	20	125	37	20	25	LLSDN42	LLP24	DCK2613	DCS1	DC0621T	TKY20F
DDJNR/L2525M15	●	●		1504	25	25	150	37	25	32	LLSDN43 (LLSDN42)	LLP24	DCK2613	DCS1	DC0621T	TKY20F
DDJNR/L2525M15-T	●	●		1506	25	25	150	37	25	32	LLSDN42	LLP24	DCK2613	DCS1	DC0621T	TKY20F
DDJNR/L3225P15	●	●		1504	32	25	170	37	32	32	LLSDN43 (LLSDN42)	LLP24	DCK2613	DCS1	DC0621T	TKY20F
DDJNR/L3225P15-T	●	●		1506	32	25	170	37	32	32	LLSDN42	LLP24	DCK2613	DCS1	DC0621T	TKY20F

\*1 Spannungmoment (N · m) : DC0520T=3.5, DC0621T=5.0

\*2 Beim Einsatz von 6.35mm dicken WSP muss die Unterlegplatte LLSDN42 verwendet werden. Die Unterlegplatte für 6.35mm dicke WSP muss separat bestellt werden.

Hinweis 1) Die Abbildungen der Wendeschneidplatten dienen nur als Beispiel. Die Buchstaben bezeichnen den Spanbrecher und die Abmessung bezieht sich auf den Innenkreisdurchmesser.

● : Lagerstandard.

PDJN WSP > A105 – A111  
DDJN WSP > A105 – A111

PCBN & PKD WSP > B039 – B042, B064  
SCHNITTDATENEMPFEHLUNGEN > A074, B020



# PDHN

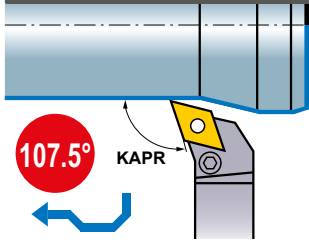

## Plan-, Kopierdrehen **LL Ausführung**

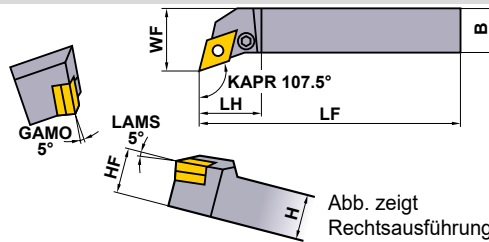

Schichten	Leicht	Mittel	Mittel
FP (15)	LP (15)	MP (15)	MK (15)
Mittlere bis Schruppen	Rostfrei	G-Toleranz	CBN
RP (15)	MM (15)	R/L (15)	(15)

Bestellbezeichnung	Lager		WSP Bezeichnung	Abmessungen (mm)							*2				*1	
	R	L		H	B	LF	LH	HF	WF	Unterlegplatte	Befestigungsfeder	Spannfinger	Spannschraube	Schlüssel		
<b>PDHNR/L2020K15</b>	●	●	DNMA DNMG DNMM	1504	20	20	125	34	20	25	LLSDN43 (LLSDN42)	LLP14	LLCL24	LLCS108	HKY30R	
<b>PDHNR/L2525M15</b>	●	●	DNGA DNMG DNMM	1504	25	25	150	34	25	32	LLSDN43 (LLSDN42)	LLP14	LLCL24	LLCS108	HKY30R	
<b>PDHNR/L3225P15</b>	●	●	DNGG DNMG	1504	32	25	170	34	32	32	LLSDN43 (LLSDN42)	LLP14	LLCL24	LLCS108	HKY30R	

\*1 Spannmoment (N · m) : LLCS108=3.3

\*2 Beim Einsatz von 6.35mm dicken WSP muss die Unterlegplatte LLSDN42 verwendet werden. Die Unterlegplatte für 6.35mm dicke WSP muss separat bestellt werden.



PDHN WSP	> A105–A111
PCBN & PKD WSP	> B039–B042, B064
SCHNITTDATENEMPFEHLUNGEN	> A074, B020

ERSATZTEILE	> N001
TECHNISCHE DATEN	> P001



## PSBN

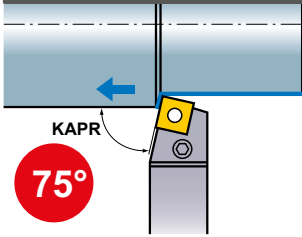

### Außendrehen LL Ausführung

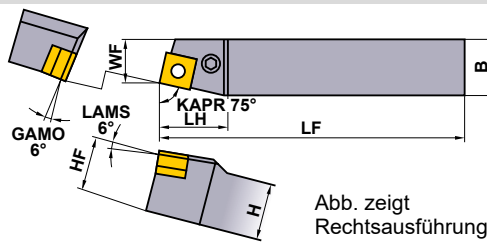

Schichten	Leicht	Mittel	Mittel
FP (12)	LP (12)	MP (12)	MK (12,15,19)
Mittlere bis Schruppen	Rostfrei	G-Toleranz	CBN
RP (12,15,19)	MM (12,15,19)	R/L (09,12)	(12)

Bestellbezeichnung	Lager		WSP Bezeichnung	Abmessungen (mm)						Zubehör						
	R	L		H	B	LF	LH	HF	WF	Unterlegplatte	Befestigungsfeder	Spannfeder	Kniehebel	Spannschraube*	Schlüssel	
PSBNR/L1212F09	●		SNMA SNMG SNGA SNGG	0903	12	12	80	20	12	13	—	—	HLS2	LLCL13S	LLCS105	HKY20R
PSBNR/L1616H09	●	●		0903	16	16	100	22	16	13	LLSSN33	LLP23	—	LLCL13	LLCS106	HKY25R
PSBNR/L2020K12	●	●		1204	20	20	125	28	20	17	LLSSN42	LLP14	—	LLCL14	LLCS108	HKY30R
PSBNR/L2525M12	●	●		1204	25	25	150	25	25	22	LLSSN42	LLP14	—	LLCL14	LLCS108	HKY30R
PSBNR/L2525M15	●	●		1506	25	25	150	33	25	22	LLSSN53	LLP15	—	LLCL25	LLCS508	HKY30R
PSBNR/L3232P19	●	●		1906	32	32	170	40	32	27	LLSSN63	LLP16	—	LLCL16	LLCS310	HKY40R

\* Spannmoment (N • m) : LLCS105=1.5, LLCS106=2.2, LLCS108=3.3, LLCS508=3.3, LLCS310=7.0

DREHEN C

## MSBN

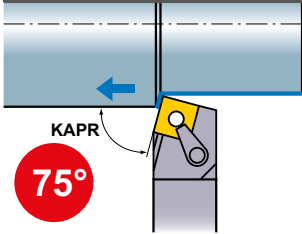

### Außendrehen DOPPELKLEMM-Ausführung Für Schwerzerspannung

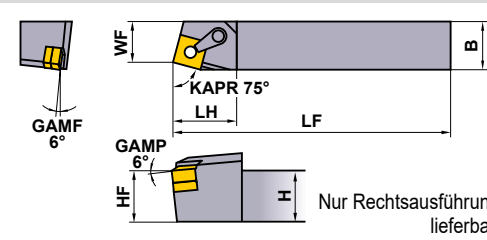

Mittel	Mittel	Mittel	Mittlere bis Schruppen
MH (19)	Standard (19)	MS (19)	RP (19)
Schwerzerspannung	Schwerzerspannung	Schwerzerspannung	Mittel
HZ (19)	HX (19)	HL (19)	Glatt (19)

Bestellbezeichnung	Lager	WSP Bezeichnung	Abmessungen (mm)						Zubehör					
	R		H	B	LF	LH	HF	WF	Unterlegplatte	Befestigungsfeder	Spannfinger	Spannschraube*	Schlüssel	
MSBNR3232P19	●	SNMG SNMM SNMA	1906	32	32	170	41	32	27	MSSN63	MP6	CKW6	LS25	HKY40R
MSBNR4040R19	●	SNMG SNMM SNMA	1906	40	40	200	41	40	35	MSSN63	MP6	CKW6	LS25	HKY40R

\* Spannmoment (N • m) : LS25=8.2

Hinweis 1) Die Abbildungen der Wendeschneidplatten dienen nur als Beispiel. Die Buchstaben bezeichnen den Spanbrecher und die Abmessung bezieht sich auf den Innenkreisdurchmesser.

● : Lagerstandard.  
★ : Lagerstandard in Japan.

PSBN WSP > A113–A118  
MSBN WSP > A114–A118

PCBN & PKD WSP > B043, B065  
SCHNITTDATENEMPFEHLUNGEN > A074, B020

Bestellbezeichnung		Lager		WSP Bezeichnung		Abmessungen (mm)							Schichten		Leicht	Mittel	Mittel
		R	L			H	B	LF	LH	HF	WF	Unterlegplatte	Befestigungsfeder	Kniehebel	Spannschraube*	Schlüssel	
<b>PSTNR/L1616H09</b>		●	●	SNMA SNMG SNMM SNGA SNGG	0903	16	16	100	20	16	13	LLSSN33	LLP23	LLCL13	LLCS106	HKY25R	
<b>PSTNR/L2020K12</b>		●	★		1204	20	20	125	25	20	17	LLSSN42	LLP14	LLCL14	LLCS108	HKY30R	
<b>PSTNR/L2525M12</b>		●	●		1204	25	25	150	25	25	22	LLSSN42	LLP14	LLCL14	LLCS108	HKY30R	

\* Spannmoment (N • m) : LLCS106=2.2, LLCS108=3.3

Bestellbezeichnung		Lager		WSP Bezeichnung		Abmessungen (mm)								Schichten		Leicht	Mittel	Mittel
		R	L			H	B	LF	LH	HF	WF	WF2	Unterlegplatte	Befestigungsfeder	Kniehebel	Spannschraube*	Schlüssel	
<b>PSSNR/L1616H09</b>		●	●	SNMA SNMG SNMM SNGA SNGG	0903	16	16	100	22	16	20	(14)	LLSSN33	LLP23	LLCL13	LLCS106	HKY25R	
<b>PSSNR/L2020K12</b>		●	●		1204	20	20	125	31	20	25	(17)	LLSSN42	LLP14	LLCL14	LLCS108	HKY30R	
<b>PSSNR/L2525M12</b>		●	●		1204	25	25	150	31	25	32	(24)	LLSSN42	LLP14	LLCL14	LLCS108	HKY30R	
<b>PSSNR/L3232P15</b>		●	●		1506	32	32	170	34	32	40	(29)	LLSSN53	LLP15	LLCL25	LLCS508	HKY30R	
<b>PSSNR/L3232P19</b>		●	●		1906	32	32	170	40	32	40	(27)	LLSSN63	LLP16	LLCL16	LLCS310	HKY40R	

Hinweis 1) Nur beim Plandrehen oder Fasen und bei Verwendung einer Wendeschneidplatte mit rechts- oder linksseitigem Spanbrecher bitte die linke Wendeschneidplatte für rechten Halter und die rechte Wendeschneidplatte für linken Halter verwenden.

\* Spannmoment (N • m) : LLCS106=2.2, LLCS108=3.3, LLCS508=3.3, LLCS310=7.0

PSTN WSP > A113–A118  
PSSN WSP > A113–A118  
PCBN & PKD WSP > B043, B065

SCHNITTDATENEMPFEHLUNGEN > A074, B020  
ERSATZTEILE > N001  
TECHNISCHE DATEN > P001

# DREHEN

## SN WSP DREHHALTER

### MSSN

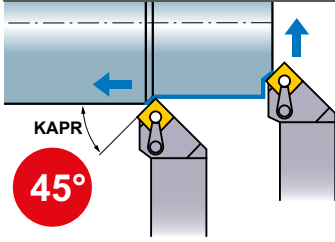

#### Außendrehen, Plandrehen, Fasen **DOPPELKLEMM-Ausführung** Für Schwerzerspannung

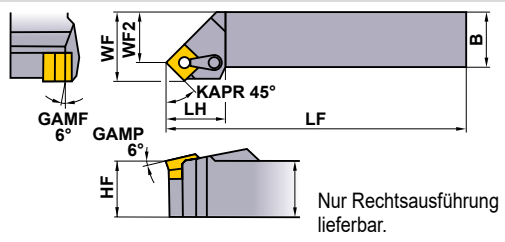

Mittel	Mittel	Mittel	Schuppen
MH (19)	Standard (19)	MS (19)	RP (19)
Schwerzerspannung HZ (19)	Schwerzerspannung HX (19)	Schwerzerspannung HL (19)	Mittel Glatt (19)

Bestellbezeichnung	Lager R	WSP Bezeichnung	Abmessungen (mm)												
			H	B	LF	LH	HF	WF	WF2	Unterlegplatte	Befestigungsfeder	Spannfinger	Spannschraube*	Schlüssel	
<b>MSSNR3232P19</b>	●	SNMG SNMM SNMA	1906	32	32	170	44	32	40	27	MSSN63	MP6	CKW6	LS25	HKY40R
<b>MSSNR4040R19</b>	●	1906	40	40	200	44	40	50	37	MSSN63	MP6	CKW6	LS25	HKY40R	

\* Spannmoment (N • m) : LS25=8.2

DREHEN

### PSDN

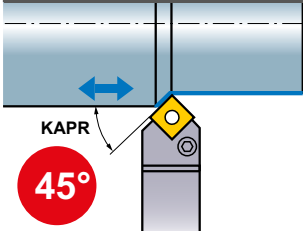

#### Außendrehen, Fasen **LL Ausführung**

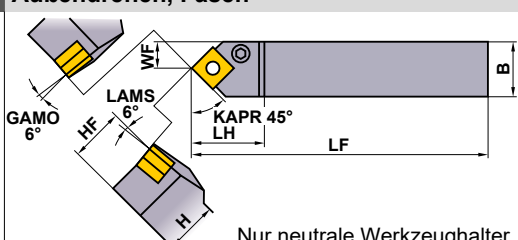

Schichten	Leicht	Mittel	Mittel
FP (12)	LP (12)	MP (12)	MK (12)
Mittlere bis Schuppen RP (12)	Rostfrei MM (12)	G-Toleranz R/L (09,12)	CBN (12)

Bestellbezeichnung	Lager	WSP Bezeichnung	Abmessungen (mm)												
			H	B	LF	LH	HF	WF	Unterlegplatte	Befestigungsfeder	Spannfeder	Kniehebel	Spannschraube*	Schlüssel	
<b>PSDNN1212F09</b>	●	0903	12	12	80	20	12	6.0	—	—	HLS2	LLCL13S	LLCS105	HKY20R	
<b>PSDNN1616H09</b>	●	SNMA SNMG	0903	16	16	100	22	16	8.0	LLSSN33	LLP23	—	LLCL13	LLCS106	HKY25R
<b>PSDNN2020K12</b>	●	SNMA SNMG SNMM	1204	20	20	125	28	20	10.0	LLSSN42	LLP14	—	LLCL14	LLCS108	HKY30R
<b>PSDNN2525M12</b>	●	SNGA SNGG	1204	25	25	150	28	25	12.5	LLSSN42	LLP14	—	LLCL14	LLCS108	HKY30R
<b>PSDNN3225P12</b>	●	1204	32	25	170	28	32	12.5	LLSSN42	LLP14	—	LLCL14	LLCS108	HKY30R	

\* Spannmoment (N • m) : LLCS105=1.5, LLCS106=2.2, LLCS108=3.3

Hinweis 1) Die Abbildungen der Wendeschneidplatten dienen nur als Beispiel. Die Buchstaben bezeichnen den Spanbrecher und die Abmessung bezieht sich auf den Innenkreisdurchmesser.

● : Lagerstandard.

MSSN WSP > A114–A118  
PSDN WSP > A113–A118

PCBN & PKD WSP > B043, B065  
SCHNITTDATENEMPFEHLUNGEN > A074, B020

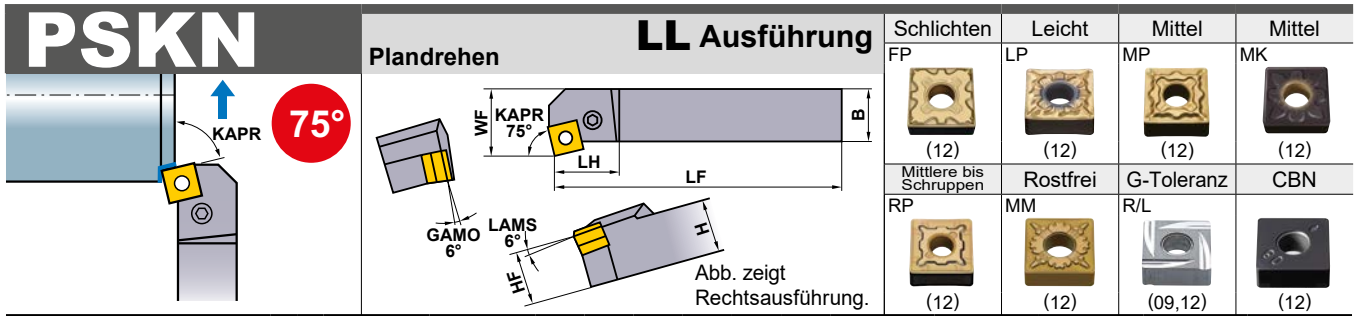

Bestellbezeichnung	Lager		WSP Bezeichnung	Abmessungen (mm)											
	R	L		H	B	LF	LH	HF	WF	Unterlegplatte	Befestigungsfeder	Kniehebel	Spannschraube*	Schlüssel	
<b>PSKNR/L1616H09</b>	●	●	SNMA SNMG	0903	16	16	100	20	16	20	LLSSN33	LLP23	LLCL13	LLCS106	HKY25R
<b>PSKNR/L2020K12</b>	●	●	SNMM SNGA	1204	20	20	125	25	20	25	LLSSN42	LLP14	LLCL14	LLCS108	HKY30R
<b>PSKNR/L2525M12</b>	●	●	SNGA SNGG	1204	25	25	150	25	25	32	LLSSN42	LLP14	LLCL14	LLCS108	HKY30R

Hinweis 1) Bei Verwendung von linken und rechten Spanbrechern, verwenden Sie bitte rechte WSP mit linken Haltern und linke WSP mit rechten Haltern.

\* Spannmoment (N • m) : LLCS106=2.2, LLCS108=3.3

**DREHEN**

PSKN WSP > A113–A118  
 PCBN & PKD WSP > B043, B065  
 SCHNITTDATENEMPFEHLUNGEN > A074, B020

ERSATZTEILE > N001  
 TECHNISCHE DATEN > P001

# DREHEN





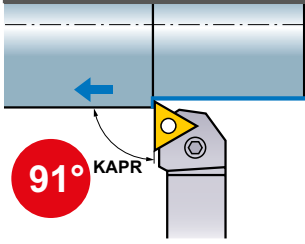

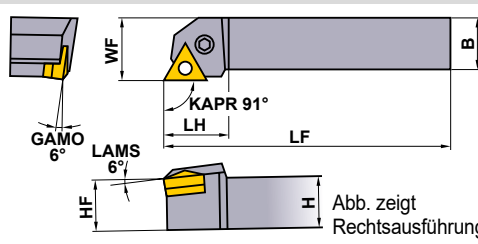

## TN WSP DREHHALTER

### PTGN



### Außendrehen LL Ausführung



Schichten	Leicht	Mittel	Mittel
FP  (16)	LP  (16,22)	MP  (16,22)	MK  (16,22)
Mittlere bis Schruppen	Rostfrei	G-Toleranz	CBN
RP  (16,22,27)	MM  (16,22)	R/L  (11,16,22)	 (16)

Bestellbezeichnung	Lager		WSP Bezeichnung	Abmessungen (mm)							*2		Spannfeder	Kniehebel	Spannschraube *1	Schlüssel
	R	L		H	B	LF	LH	HF	WF	Unterlegplatte	Befestigungsfeder					
PTGNR/L1010E11	●	●	TNMA TNMG TNMM TNGA TNGG TNGM	1103	10	10	70	17	10	12	—	—	HLS1	LLCL12S	LLCS105	HKY20F
PTGNR/L1212F11	●	●		1103	12	12	80	17	12	16	—	—	HLS1	LLCL12S	LLCS105	HKY20F
PTGNR/L1616H16	●	●		1604	16	16	100	22	16	20	LLSTN32 (LLSTN33)	LLP13 (LLP23)	—	LLCL13	LLCS106	HKY25R
PTGNR/L2020K16	●	●		1604	20	20	125	22	20	25	LLSTN32 (LLSTN33)	LLP13 (LLP23)	—	LLCL13	LLCS106	HKY25R
PTGNR/L2525M16	●	●		1604	25	25	150	22	25	32	LLSTN32 (LLSTN33)	LLP13 (LLP23)	—	LLCL13	LLCS206	HKY25R
PTGNR/L2525M22	●	●		2204	25	25	150	28	25	32	LLSTN42	LLP14	—	LLCL14	LLCS108	HKY30R
PTGNR/L3225P22	●	●		2204	32	25	170	28	32	32	LLSTN42	LLP14	—	LLCL14	LLCS108	HKY30R
PTGNR/L3232P27	●	●		2706	32	32	170	35	32	40	LLSTN53	LLP15	—	LLCL25	LLCS508	HKY30R

\*1 Spannmoment (N · m) : LLCS105=1.5, LLCS106=2.2, LLCS206=2.2, LLCS108=3.3, LLCS508=3.3

PTGNR/L1010E11 • PTGNR/L1212F11 Spannmoment (N · m) : LLCS105=1.0

\*2 Beim Einsatz von 3.18mm dicken WSP muß die Unterlegplatte LLSTN33 und Befestigungsfeder LLP23 verwendet werden. Die Unterlegplatte und Befestigungsfeder für die 3.18mm dicke WSP müssen separat bestellt werden.

### DTGN

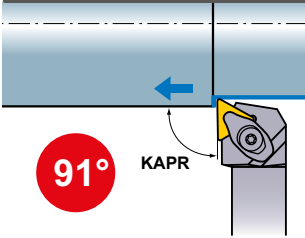

### Außendrehen DOPPELKLEMM-Ausführung

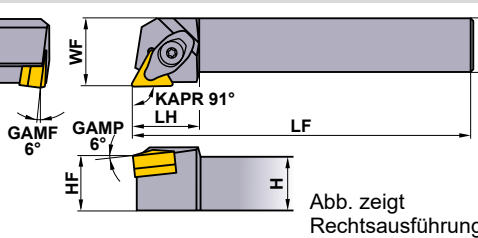

Schichten	Leicht	Mittel	Mittel
FP  (16)	LP  (16)	MP  (16)	MK  (16)
Mittlere bis Schruppen	Rostfrei	G-Toleranz	CBN
RP  (16)	MM  (16)	R/L  (16)	 (16)

Bestellbezeichnung	Lager		WSP Bezeichnung	Abmessungen (mm)							*2		Spannfinger	Feder	Spannschraube *1	Schlüssel
	R	L		H	B	LF	LH	HF	WF	Unterlegplatte	Befestigungsfeder					
DTGNR/L1616H16	●	●	TNMA TNMG TNMM TNGA TNGG TNGM	1604	16	16	100	25	16	20	LLSTN32 (LLSTN33)	LLP23	DCK2211	DCS2	DC0520T	TKY15F
DTGNR/L1616H16-T	●	●		1603	16	16	100	25	16	20	LLSTN33	LLP23	DCK2211	DCS2	DC0520T	TKY15F
DTGNR/L2020K16	●	●		1604	20	20	125	25	20	25	LLSTN32 (LLSTN33)	LLP23	DCK2211	DCS2	DC0520T	TKY15F
DTGNR/L2020K16-T	●	●		1603	20	20	125	25	20	25	LLSTN33	LLP23	DCK2211	DCS2	DC0520T	TKY15F
DTGNR/L2525M16	●	●		1604	25	25	150	25	25	32	LLSTN32 (LLSTN33)	LLP23	DCK2211	DCS2	DC0520T	TKY15F
DTGNR/L2525M16-T	●	●		1603	25	25	150	25	25	32	LLSTN33	LLP23	DCK2211	DCS2	DC0520T	TKY15F

\*1 Spannmoment (N · m) : DC0520T=3.5

\*2 Beim Einsatz von 3.18mm dicken WSP muß die Unterlegplatte LLSTN33 verwendet werden. Die Unterlegplatte für 3.18mm dicke WSP muß separat bestellt werden.

Hinweis 1) Die Abbildungen der Wendeschneidplatten dienen nur als Beispiel. Die Buchstaben bezeichnen den Spanbrecher und die Abmessung bezieht sich auf den Innenkreisdurchmesser.

● : Lagerstandard.

PTGN WSP > A119–A125  
DTGN WSP > A119–A125

PCBN & PKD WSP > B044, B045, B065  
SCHNITTDATENEMPFEHLUNGEN > A074, B020

Bestellbezeichnung		Lager		WSP Bezeichnung	Abmessungen (mm)							*2		*1	
		R	L		H	B	LF	LH	HF	WF	Unterlegplatte	Befestigungsfeder	Kniehebel	Spannschraube	Schlüssel
<b>PTFNR/L1616H16</b>	●●	TNMA	1604	16	16	100	22	16	20	LLSTN32 (LLSTN33)	LLP13 (LLP23)	LLCL13	LLCS106	HKY25R	
<b>PTFNR/L2020K16</b>	●●	TNMG	1604	20	20	125	22	20	25	LLSTN32 (LLSTN33)	LLP13 (LLP23)	LLCL13	LLCS106	HKY25R	
<b>PTFNR/L2525M16</b>	●●	TNMM	1604	25	25	150	22	25	32	LLSTN32 (LLSTN33)	LLP13 (LLP23)	LLCL13	LLCS206	HKY25R	
<b>PTFNR/L2525M22</b>	●●	TNGA TNGG TNGM	2204	25	25	150	28	25	32	LLSTN42	LLP14	LLCL14	LLCS108	HKY30R	

Hinweis 1) Bei Verwendung von linken und rechten Spanbrechern, verwenden Sie bitte rechte WSP mit linken Haltern und linke WSP mit rechten Haltern.

\*1 Spannungmoment (N · m) : LLCS106=2.2, LLCS206=2.2, LLCS108=3.3

\*2 Beim Einsatz von 3.18mm dicken WSP muss die Unterlegplatte LLSTN33 und Befestigungsfeder LLP23 verwendet werden. Die Unterlegplatte für 3.18mm dicke WSP muss separat bestellt werden.

Bestellbezeichnung		Lager		WSP Bezeichnung	Abmessungen (mm)							*2		*1		
		R	L		H	B	LF	LH	HF	WF	Unterlegplatte	Befestigungsfeder	Spannfinger	Seitl. Anlegeplatte	Feder	Spannschraube
<b>MTJNR/L2020K16N</b>	●●	TN A	1604	20	20	125	31	20	25	WPSTN33	CCP33	CCK13	CPT13	MES2	SLCS105	HKY25R HKY40R
<b>MTJNR/L2525M16N</b>	●●	TN G	1604	25	25	150	31	25	32	WPSTN33	CCP33	CCK13	CPT13	MES2	SLCS105	HKY25R HKY40R
<b>MTJNR/L2525M22N</b>	●●	TN M	2204	25	25	150	38	25	32	WPSTN43	CCP34	CCK14	CPT14	MES3	SLCS106	HKY30R HKY40R

\*1 Spannungmoment (N · m) : SLCS105=7.0, SLCS106=7.0

\*2 Spannschlüssel HKY25R, HKY30R für Befestigungsfeder, Spannschlüssel HKY40R für Spannschraube.

PTFN WSP > A119 – A125  
 MTJN WSP > A119 – A125  
 PCBN & PKD WSP > B044, B045, B065

SCHNITTDATENEMPFEHLUNGEN > A074, B020  
 ERSATZTEILE > N001  
 TECHNISCHE DATEN > P001



# DREHEN

## TN WSP DREHHALTER

### MTEN

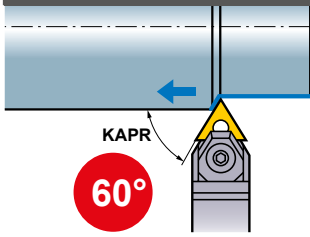

#### Außendrehen, Fasen WP Ausführung

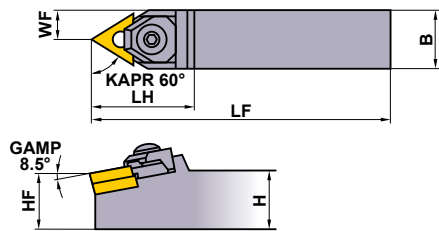

Schichten	Leicht	Mittel	Mittel
FP  (16)	LP  (16.22)	MP  (16.22)	MK  (16.22)
Mittlere bis Schruppen	Rostfrei	G-Toleranz	CBN
RP  (16.22)	MM  (16.22)	R/L  (16.22)	 (16)

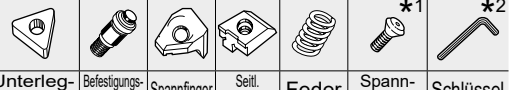
Bestellbezeichnung	Lager	WSP Bezeichnung	Abmessungen (mm)														
			H	B	LF	LH	HF	WF	Unterlegplatte	Befestigungsfeder	Spannfinger	Seitl. Anlegeplatte	Feder	Spannschraube	Schlüssel		
<b>MTENN2020K16N</b>	●	TN:A TN:G 1604	20	20	125	34	20	10	WPSTN33	CCP33	CCK13	CPT13	MES2	SLCS105	HKY25R HKY40R		
<b>MTENN2525M22N</b>	●	TN:M TN:MX 2204	25	25	150	44	25	12.5	WPSTN43	CCP34	CCK14	CPT14	MES3	SLCS106	HKY30R HKY40R		

\*1 Spannmoment (N · m) : SLCS105=7.0, SLCS106=7.0

\*2 Spannschlüssel HKY25R, HKY30R für Befestigungsfeder, Spannschlüssel HKY40R für Spannschraube.

DREHEN

### MTQN

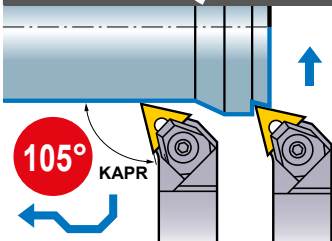

#### Plan-, Kopierdrehen WP Ausführung

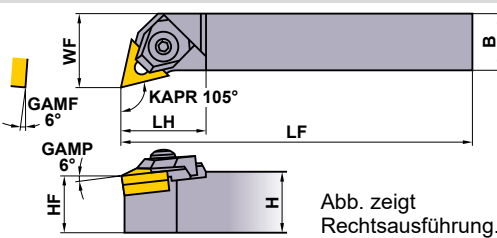

Schichten	Leicht	Mittel	Mittel
FP  (16)	LP  (16.22)	MP  (16.22)	MK  (16.22)
Mittlere bis Schruppen	Rostfrei	G-Toleranz	CBN
RP  (16.22)	MM  (16.22)	R/L  (16.22)	 (16)

Bestellbezeichnung	Lager		WSP Bezeichnung	Abmessungen (mm)														
	R	L		H	B	LF	LH	HF	WF	Unterlegplatte	Befestigungsfeder	Spannfinger	Seitl. Anlegeplatte	Feder	Spannschraube	Schlüssel		
<b>MTQNR/L2020K16N</b>	●	●	TN:A TN:G 1604	20	20	125	31	20	25	WPSTN33	CCP33	CCK13	CPT13	MES2	SLCS105	HKY25R HKY40R		
<b>MTQNR/L2525M22N</b>	●	●	TN:M TN:MX 2204	25	25	150	36	25	32	WPSTN43	CCP34	CCK14	CPT14	MES3	SLCS106	HKY30R HKY40R		

Hinweis 1) Beim Einsatz von rechten und linken WSP, rechte WSP für linke Halter, linke WSP für rechte Halter.

\*1 Spannmoment (N · m) : SLCS105=7.0, SLCS106=7.0

\*2 Spannschlüssel HKY25R, HKY30R für Befestigungsfeder, Spannschlüssel HKY40R für Spannschraube.

Hinweis 2) Die Abbildungen der Wendeschneidplatten dienen nur als Beispiel. Die Buchstaben bezeichnen den Spanbrecher und die Abmessung bezieht sich auf den Innenkreisdurchmesser.

● : Lagerstandard.  
★ : Lagerstandard in Japan.

MTEN WSP > A119–A125  
MTQN WSP > A119–A125

PCBN & PKD WSP > B044, B045, B065  
SCHNITTDATENEMPFEHLUNGEN > A074, B020

PVJN		Außen-, Kopierdrehen		MP Ausführung						Schichten						
										Leicht	Mittel	Mittel	Mittel			
Bestellbezeichnung		Lager		WSP Bezeichnung		Abmessungen (mm)						*2		*1		
						R	L	H	B	LF	LH	HF	WF	Unterlegplatte	Exzenterstift	Verriegelungsschraube
<b>PVJNR/L2020K16</b>		●	●	VN A	1604	20	20	125	32	20	25	PV322 (PV321) (PV323)	P11S	HSP05008C	E03	HKY25R
<b>PVJNR/L2525M16</b>		●	●	VN G VN M	1604	25	25	150	38	25	32	P11S	HSP05008C	E03	HKY25R	

\*1 Spannmoment (N • m) : HSP05008C=2.5

\*2 Bitte folgende Unterlegplatten PV321 und PV323 bei Wendeschneidplatten mit größeren RE 0,4 mm und RE 1,2 mm verwenden.  
Bei Verwendung von Wendeschneidplatten sollte die Unterlegplatte separat bestellt werden.

DVJN		Außen-, Kopierdrehen		DOPPELKLEMM-Ausführung						Schichten							
										Leicht	Mittel	Mittel	Mittel				
Bestellbezeichnung		Lager		WSP Bezeichnung		Abmessungen (mm)						*2		*1			
						R	L	H	B	LF	LH	HF	WF	Unterlegplatte	Befestigungsfeder	Spannfinger	Feder
<b>DVJNR/L2020K16</b>		●	●	VN A	1604	20	20	125	41	20	25	DCSVN32	LLP13	DCK3113	DCS2	DC0520T	TKY15F
<b>DVJNR/L2525M16</b>		●	●	VN G VN M	1604	25	25	150	41	25	32	DCSVN32	LLP13	DCK3113	DCS2	DC0520T	TKY15F

\* Spannmoment (N • m) : DC0520T=3.5



# DREHEN

## VN WSP DREHHALTER

### DVVN

#### Außen-, Kopierdrehen **DOPPELKLEMM-Ausführung**

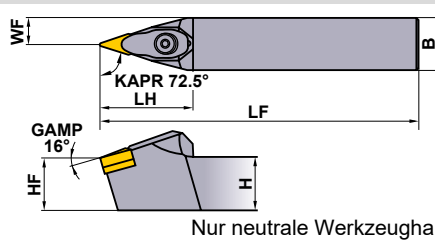
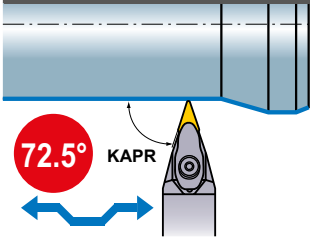

Nur neutrale Werkzeughalter.

Schichten	Leicht	Mittel	Mittel
FP	LP	MP	MK
(16)	(16)	(16)	(16)
Mittel	Rostfrei	G-Toleranz	CBN
Standard	MM	R/L	
(16)	(16)	(16)	(16)

Bestellbezeichnung	Lager	WSP Bezeichnung	Abmessungen (mm)												
			H	B	LF	LH	HF	WF	Unterlegplatte	Befestigungsfeder	Spannfinger	Feder	Spannschraube	Schlüssel	
<b>DVVNN2020K16</b>	●	VN A VN G VN M	1604	20	20	125	44	20	10	DCSVN32	LLP13	DCK3113	DCS2	DC0520T	TKY15F
<b>DVVNN2525M16</b>	●	VN A VN G VN M	1604	25	25	150	44	25	12.5	DCSVN32	LLP13	DCK3113	DCS2	DC0520T	TKY15F

\* Spannmoment (N • m) : DC0520T=3.5

### PVVN

#### Außen-, Kopierdrehen **MP Ausführung**

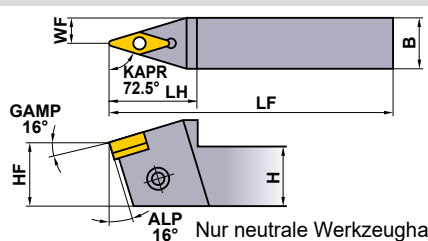
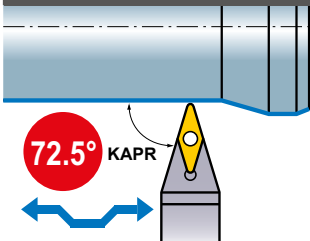

Nur neutrale Werkzeughalter.

Schichten	Leicht	Mittel	Mittel
FP	LP	MP	MK
(16)	(16)	(16)	(16)
Mittel	Rostfrei	G-Toleranz	CBN
Standard	MM	R/L	
(16)	(16)	(16)	(16)

Bestellbezeichnung	Lager	WSP Bezeichnung	Abmessungen (mm)											
			H	B	LF	LH	HF	WF	Unterlegplatte	Exzenterstift	Verriegelungsschraube	Anschlagring	Schlüssel	
<b>PVVNN2020K16</b>	●	VN A VN G VN M	1604	20	20	125	38	20	10	PV322 (PV321) (PV323)	P11S	HSP05008C	E03	HKY25R
<b>PVVNN2525M16</b>	●	VN A VN G VN M	1604	25	25	150	38	25	12.5	PV322 (PV321) (PV323)	P11S	HSP05008C	E03	HKY25R

\*1 Spannmoment (N • m) : HSP05008C=2.5

\*2 Bitte folgende Unterlegplatten PV321 und PV323 bei Wendeschneidplatten mit größeren RE 0,4 mm und RE 1,2 mm verwenden.

Spannschlüssel HKY25R, HKY30R für Befestigungsfeder, Spannschlüssel HKY40R für Spannschraube

Hinweis 1) Die Abbildungen der Wendeschneidplatten dienen nur als Beispiel. Die Buchstaben bezeichnen den Spanbrecher und die Abmessung bezieht sich auf den Innenkreisdurchmesser.

● : Lagerstandard.  
★ : Lagerstandard in Japan.

DVVN WSP > A126–A129  
PVVN WSP > A126–A129

PCBN & PKD WSP > B046, B047, B066  
SCHNITTDATENEMPFEHLUNGEN > A074, B020

Bestellbezeichnung		Lager		WSP Bezeichnung		Abmessungen (mm)						Schichten		Leicht	Mittel	Mittel	
		R	L			H	B	LF	LH	HF	WF	Unterlegplatte	Befestigungs-feder	Spannfinger	Feder	Spann-schraube	Schlüssel
<b>DVPNR/L2020K16</b>		●	★	VN: A	1604	20	20	125	32	20	25	DCSVN32	LLP13	DCK3113	DCS2	DC0520T	TKY15F
<b>DVPNR/L2525M16</b>		●	●	VN: G VN: M	1604	25	25	150	32	25	32	DCSVN32	LLP13	DCK3113	DCS2	DC0520T	TKY15F

\* Spannmoment (N • m) : DC0520T=3.5

Bestellbezeichnung		Lager		WSP Bezeichnung		Abmessungen (mm)						Schichten		Leicht	Mittel	Mittel
		R	L			H	B	LF	LH	HF	WF	Unterlegplatte	Exzenterstift	Verriegelungs-schraube	Anschlagring	Schlüssel
<b>PVNR/L2020K16</b>		●	●	VN: A	1604	20	20	125	32	20	25	PV322 (PV321)	P11S	HSP05008C	E03	HKY25R
<b>PVNR/L2525M16</b>		●	●	VN: G VN: M	1604	25	25	150	32	25	32	(PV323)	P11S	HSP05008C	E03	HKY25R

\*1 Spannmoment (N • m) : HSP05008C=2.5

\*2 Bitte folgende Unterlegplatten PV321 und PV323 bei Wendeschneidplatten mit größeren RE 0,4 mm und RE 1,2 mm verwenden.  
Bei Verwendung von Wendeschneidplatten sollte die Unterlegplatte separat bestellt werden.

DVPN WSP > A126 – A129  
 PVPN WSP > A126 – A129  
 PCBN & PKD WSP > B046, B047, B066

SCHNITTDATENEMPFEHLUNGEN > A074, B020  
 ERSATZTEILE > N001  
 TECHNISCHE DATEN > P001



# DREHEN

## WN WSP DREHHALTER

### PWLN

Außendrehen, Plandrehen

LL Ausführung

Leicht	Mittel
LP  (06)	MP  (06)
Rostfrei	
MM  (06)	

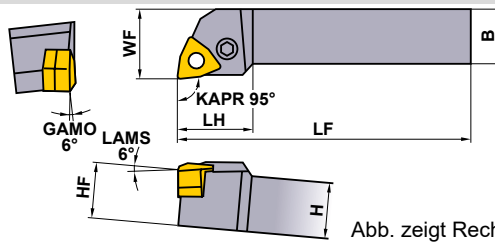
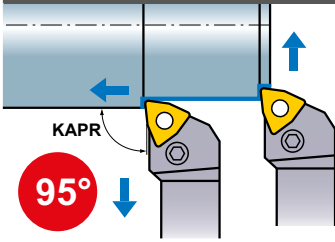

Bestellbezeichnung	Lager		WSP Bezeichnung	Abmessungen (mm)							*2				*1	
	R	L		H	B	LF	LH	HF	WF	Unterlegplatte	Befestigungsfeder	Kniehebel	Spannschraube	Schlüssel		
PWLN/L1616H06	●	●	WNMG	06T3	16	16	100	22	16	20	LLSWN3T3 (LLSWN32)	LLP13	LLCL13	LLCS106	HKY25R	
PWLN/L2020K06	●	●		06T3	20	20	125	22	20	25	LLSWN3T3 (LLSWN32)	LLP13	LLCL13	LLCS106	HKY25R	
PWLN/L2525M06	●	●		06T3	25	25	150	25	25	32	LLSWN3T3 (LLSWN32)	LLP13	LLCL13	LLCS106	HKY25R	

\*1 Spannmoment (N · m) : LLCS106=2.2

\*2 Beim Einsatz von 4.76mm dicken WSP muss die Unterlegplatte LLSWN32 verwendet werden. Die Unterlegplatte für 4.76mm dicke WSP muss separat bestellt werden.

DREHEN C

### DWLN

Außendrehen, **DOPPELKLEMM**-Ausführung Plandrehen

Schichten	Leicht	Mittel	Mittel
FP  (08)	LP  (06,08)	MP  (06,08)	MK  (08)
Mittel	Mittlere bis Schruppen	Rostfrei	CBN
Standard  (08)	RP  (08)	MM  (06,08)	 (08)

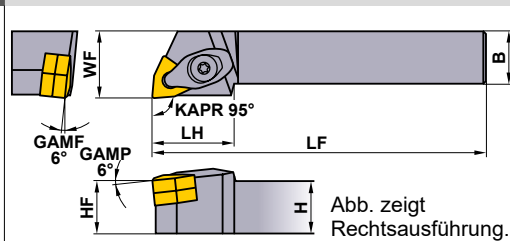
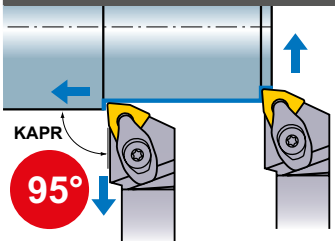

Bestellbezeichnung	Lager		WSP Bezeichnung	Abmessungen (mm)							*2				*1	
	R	L		H	B	LF	LH	HF	WF	Unterlegplatte	Befestigungsfeder	Spannfinger	Feder	Spannschraube	Schlüssel	
DWLN/L1616H06	●	●	WNMA WNMG WNGA	06T3	16	16	100	25	16	20	LLSWN3T3 (LLSWN32)	LLP23	DCK2211	DCS2	DC0520T	TKY15F
DWLN/L2020K06	●	●		06T3	20	20	125	25	20	25	LLSWN3T3 (LLSWN32)	LLP23	DCK2211	DCS2	DC0520T	TKY15F
DWLN/L2020K06-T	●	●		0604	20	20	125	25	20	25	LLSWN32	LLP23	DCK2211	DCS2	DC0520T	TKY15F
DWLN/L2525M06	●	●		06T3	25	25	150	25	25	32	LLSWN3T3 (LLSWN32)	LLP23	DCK2211	DCS2	DC0520T	TKY15F
DWLN/L2525M06-T	●	●		0604	25	25	150	25	25	32	LLSWN32	LLP23	DCK2211	DCS2	DC0520T	TKY15F
DWLN/L2020K08	●	●		0804	20	20	125	31	20	25	LLSWN42	LLP14	DCK2613	DCS1	DC0621T	TKY20F
DWLN/L2525M08	●	●		0804	25	25	150	31	25	32	LLSWN42	LLP14	DCK2613	DCS1	DC0621T	TKY20F
DWLN/L3225P08	●	●		0804	32	25	170	31	32	32	LLSWN42	LLP14	DCK2613	DCS1	DC0621T	TKY20F

\*1 Spannmoment (N · m) : DC0520T=3.5, DC0621T=5.0

\*2 Beim Einsatz von 4.76mm dicken WSP muss die Unterlegplatte LLSWN32 verwendet werden. Die Unterlegplatte für 4.76mm dicke WSP muss separat bestellt werden.

Hinweis 1) Die Abbildungen der Wendeschneidplatten dienen nur als Beispiel. Die Buchstaben bezeichnen den Spanbrecher und die Abmessung bezieht sich auf den Innendurchmesser.

● : Lagerstandard.

PWLN WSP > A130–A133  
DWLN WSP > A130–A134

PCBN WSP > B048  
SCHNITTDATENEMPFEHLUNGEN > A074, B020

MWLN		Außendrehen, Fasen		WP Ausführung						Schichten		Leicht	Mittel	Mittel			
										FP	LP	MP	MK				
				 (08)		 (08)		 (08)		 (08)							
				Mittel	Mittlere bis Schruppen	Rostfrei	CBN										
		 Abb. zeigt Rechtsausführung.		 (08)		 (08)		 (08)		 (08)							
				Standard	RP	MM											
Bestellbezeichnung	Lager		WSP Bezeichnung	Abmessungen (mm)													
	R	L		H	B	LF	LH	HF	WF	Unterlegplatte	Befestigungsfeder	Seitl. Anlegeplatte	Spannring	Spannschraube*	Feder	Schlüssel	
MWLN/L2020K08	●	●	WNMA WNMG WNGA	0804	20	20	125	32	20	25	WPSWN43	CCP34	CPT24	CCK13	SLCS105	MES2	HKY40R
MWLN/L2525M08	●	●		0804	25	25	150	32	25	32	WPSWN43	CCP34	CPT24	CCK13	SLCS105	MES2	HKY40R
MWLN/L3225P08	●	●		0804	32	25	170	32	32	32	WPSWN43	CCP34	CPT24	CCK13	SLCS105	MES2	HKY40R

\* Spannmoment (N • m) : SLCS105=7.0

DREHEN

MWLN WSP > A130 – A134  
 PCBN WSP > B048  
 SCHNITTDATENEMPFEHLUNGEN > A074, B020

ERSATZTEILE > N001  
 TECHNISCHE DATEN > P001

# DREHEN



## SCLC

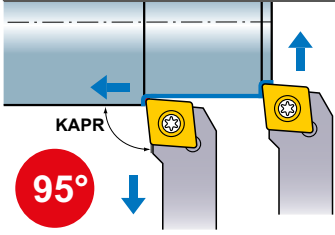

### Außendrehen, Fasen **SP Ausführung**





Abb. zeigt Rechtsausführung.

Schichten	Leicht	Mittel	Rostfrei
FP  (06,09)	LP  (06,09)	MP  (06,09,12)	FM  (06,09)
Rostfrei	Rostfrei	Glatt	PKD/CBN
LM  (06,09)	MM  (06,09,12)	 (06,09,12)	 (06,09,12)

Bestellbezeichnung	Lager		WSP Bezeichnung	Abmessungen (mm)						*1										
	R	L		H	B	LF	LH	HF	WF	Spanschraube	Schlüssel									
<b>SCLCR/L0808D06</b>	●	●	<table border="0"> <tr><td>CC</td><td>B</td></tr> <tr><td>CC</td><td>H #2</td></tr> <tr><td>CC</td><td>T</td></tr> <tr><td>CC</td><td>W</td></tr> </table>	CC	B	CC	H #2	CC	T	CC	W	0602	8	8	60	8.9	8	10	TS25	TKY08F
CC	B																			
CC	H #2																			
CC	T																			
CC	W																			
<b>SCLCR/L1010E06</b>	●	●	0602	10	10	70	8.9	10	12	TS25	TKY08F									
<b>SCLCR/L1212F09</b>	●	●	09T3	12	12	80	13.6	12	16	TS43	TKY15F									
<b>SCLCR/L1616H12</b>	●	●	1204	16	16	100	16.7	16	20	TS5	TKY25F									

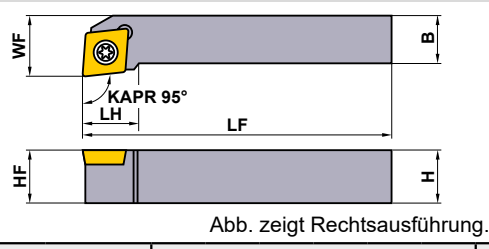
\*1 Spannmoment (N · m) : TS25=1.0, TS43=3.5, TS5=7.5

\*2 Bei Verwendung von CCGH und CCMH Wendeschneidplatten wird die Verwendung der Spanschraube TS253 empfohlen.







Hinweis 1) Die Abbildungen der Wendeschneidplatten dienen nur als Beispiel. Die Buchstaben bezeichnen den Spanbrecher und die Abmessung bezieht sich auf den Innenkreisdurchmesser.

DREHEN

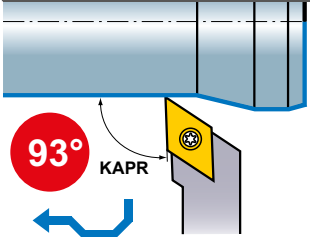
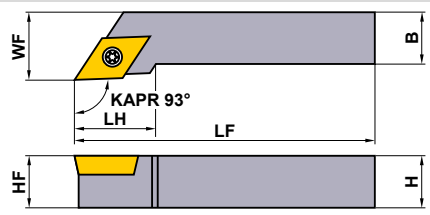





C

● : Lagerstandard.

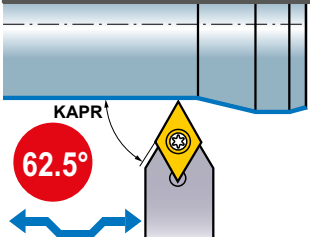
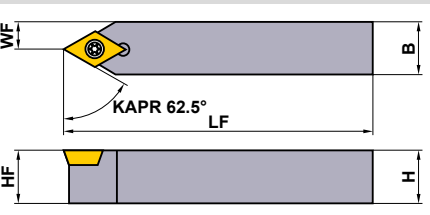
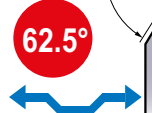
SCLC WSP	> A139 – A145
PCBN & PKD WSP	> B051, B052, B067
SCHNITTDATENEMPFEHLUNGEN	> A074, B020

SDJC		Außen-, Kopierdrehen		SP Ausführung					Schichten				
									Leicht	Mittel	Rostfrei		
				FP	LP	MP	FM	FP	LP	MP	FM		
				Rostfrei				Glatt		PKD/CBN			
				LM	MM			LM	MM				
Bestellbezeichnung	Lager	WSP Bezeichnung		Abmessungen (mm)									
	R L			H	B	LF	LH	HF	WF	Unterlegplatte	Schraube Unterlegplatte	Spannschraube	Schlüssel
SDJCR/L1010E07	● ●	DCET DCGT DCMW DCMT DCGW	0702	10	10	70	12	10	12	—	—	TS25	TKY08F
SDJCR/L1212F11	● ●		11T3	12	12	80	18	12	16	—	—	TS43	TKY15F
SDJCR/L1616H11	● ●		11T3	16	16	100	18	16	20	—	—	TS43	TKY15F
SDJCR/L2020K11	● ●		11T3	20	20	125	18	20	25	SPSDN32	JSS6	TS406	TKY15R
SDJCR/L2525M11	● ●		11T3	25	25	150	25	25	32	SPSDN32	JSS6	TS406	TKY15R

\* Spannmoment (N • m) : TS25=1.0, TS43=3.5

SDNC		Außen-, Kopierdrehen		SP Ausführung					Schichten			
									Leicht	Mittel	Rostfrei	
				FP	LP	MP	FM	FP	LP	MP	FM	
				Rostfrei				Glatt		PKD/CBN		
				LM	MM			LM	MM			
Bestellbezeichnung	Lager	WSP Bezeichnung		Abmessungen (mm)								
	R L			H	B	LF	HF	WF	Unterlegplatte	Schraube Unterlegplatte	Spannschraube	Schlüssel
SDNCN0808D07	●	DCET DCGT DCMW DCMT DCGW	0702	8	8	60	8	4	—	—	TS25	TKY08F
SDNCN1010E07	●		0702	10	10	70	10	5	—	—	TS25	TKY08F
SDNCN1212F11	●		11T3	12	12	80	12	6	—	—	TS43	TKY15F
SDNCN1616H11	●		11T3	16	16	100	16	8	—	—	TS43	TKY15F
SDNCN2525M11	●		11T3	25	25	150	25	12.5	SPSDN32	JSS6	TS406	TKY15R

\* Spannmoment (N • m) : TS25=1.0, TS43=3.5

# DREHEN

## RC WSP DREHHALTER

### PRGC

Außen-, Plan-, Kopierdrehen

LL Ausführung

Mittel



Abb. zeigt Rechtsausführung.



(10,12,16,20)

Schwerzerspannung

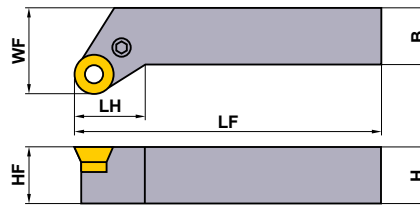
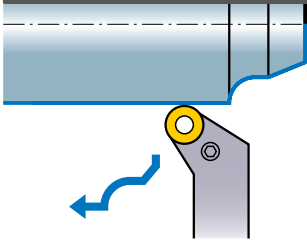
RR



(16,20)

Bestellbezeichnung	Lager		WSP Bezeichnung	Abmessungen (mm)						Unterlegplatte	Befestigungsfeder	Kniehebel	Spannschraube	Schlüssel	
	R	L		H	B	LF	LH	HF	WF						
PRGCR/L2525M10	●	●	RCMX	1003M0	25	25	150	16.7	25	32	LLSRN103	LLP13	LLCL110	LLCS205	HKY20R
PRGCR/L2525M12	●	●		1204M0	25	25	150	17.5	25	32	LLSRN123	LLP13	LLCL112	LLCS106	HKY25R
PRGCR/L2525M16	●	★		1606M0	25	25	150	19.9	25	32	LLSRN164	LLP24	LLCL116	LLCS306	HKY25R
PRGCR/L3232P20	●	●		2006M0	32	32	170	23.8	32	40	LLSRN204	LLP15	LLCL120	LLCS508	HKY30R

\* Spannmoment (N • m) : LLCS205=1.5, LLCS106=2.2, LLCS306=2.2, LLCS508=3.3

DREHEN

C

### PRDC

Außen-, Kopierdrehen

LL Ausführung

Mittel

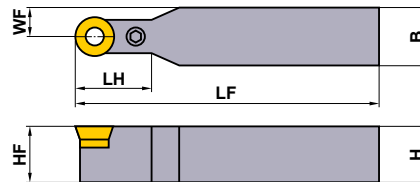
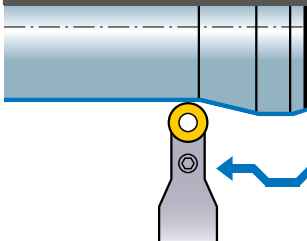

Nur neutrale Werkzeughalter.



(10,12,16,20)

Schwerzerspannung

RR



(16,20)

Bestellbezeichnung	Lager		WSP Bezeichnung	Abmessungen (mm)						Unterlegplatte	Befestigungsfeder	Kniehebel	Spannschraube	Schlüssel	
	R	L		H	B	LF	LH	HF	WF						
PRDCN2020K10	●	●	RCMX	1003M0	20	20	125	23	20	10.0	LLSRN103	LLP13	LLCL110	LLCS205	HKY20R
PRDCN2525M12	●	●		1204M0	25	25	150	24	25	12.5	LLSRN123	LLP13	LLCL112	LLCS106	HKY25R
PRDCN3225P12	●	●		1204M0	32	25	170	24	32	12.5	LLSRN123	LLP13	LLCL112	LLCS106	HKY25R
PRDCN3225P16	●	●		1606M0	32	25	170	28	32	12.5	LLSRN164	LLP24	LLCL116	LLCS306	HKY25R
PRDCN3232P20	●	●		2006M0	32	32	170	33	32	16.0	LLSRN204	LLP15	LLCL120	LLCS508	HKY30R

\* Spannmoment (N • m) : LLCS205=1.5, LLCS106=2.2, LLCS306=2.2, LLCS508=3.3

Hinweis 1) Die Abbildungen der Wendeschneidplatten dienen nur als Beispiel. Die Buchstaben bezeichnen den Spanbrecher und die Abmessung bezieht sich auf den Innkreisdurchmesser.

● : Lagerstandard. ★ : Lagerstandard in Japan.

PRGC WSP > A154  
 PRDC WSP > A154  
 SCHNITTDATENEMPFEHLUNGEN > A074, B020

# SRGC

**Außen-, Plan-, Kopierdrehen** **SP Ausführung**

Mittlere Zerspanung  
Schlitzzerspanung  
AZ



(08)

Mittel

Standard

(06,08)

Abb. zeigt Rechtsausführung.

Bestellbezeichnung	Lager		WSP Bezeichnung		Abmessungen (mm)					* 		
	R	L			H	B	LF	LH	HF	WF	Spannschraube	Schlüssel
<b>SRGCR/L1616H06</b>	●	●	RCMT	0602	16	16	100	10	16	20	TS25	TKY08F
<b>SRGCR/L1616H08</b>	●	●	RCGT	0803	16	16	100	14.5	16	22	TS3	TKY08F

\* Spannmoment (N • m) : TS25=1.0, TS3=1.0

**DREHEN**

# SRDC

**Außen-, Kopierdrehen** **SP Ausführung**



Mittlere Zerspanung  
Schlitzzerspanung  
AZ

(08)

Mittel

Standard

(06,08)

Bestellbezeichnung	Lager		WSP Bezeichnung		Abmessungen (mm)					* 		
	R	L			H	B	LF	LH	HF	WF	Spannschraube	Schlüssel
<b>SRDCN1616H06</b>	●	●	RCMT	0602	16	16	100	12	16	8	TS25	TKY08F
<b>SRDCN1616H08</b>	●	●	RCGT	0803	16	16	100	16	16	8	TS3	TKY08F

\* Spannmoment (N • m) : TS25=1.0, TS3=1.0

SRGC WSP > A154  
 SRDC WSP > A154  
 SCHNITTDATENEMPFEHLUNGEN > A074, B020

ERSATZTEILE > N001  
 TECHNISCHE DATEN > P001









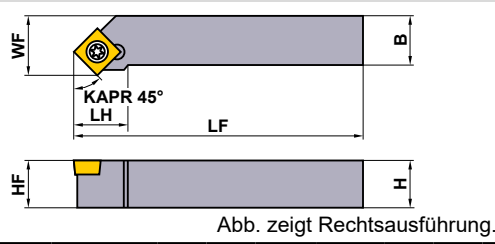
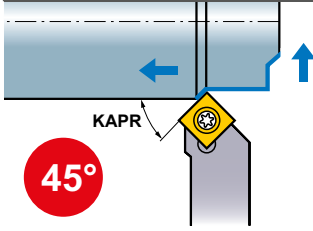

# DREHEN

**SC** WSP  
DREHHALTER

**SSSC**

Außendrehen, Fasen, **SP** Ausführung  
Plan-



Schichten	Leicht	Mittel	Rostfrei
FP  (09)	LP  (09)	MP  (09,12)	FM  (09)
Rostfrei	Rostfrei	Mittel	Glatt
LM  (09)	MM  (09,12)	Standard  (09,12)	 (09,12)

Bestellbezeichnung	Lager		WSP Bezeichnung	Abmessungen (mm)										
	R	L		H	B	LF	LH	HF	WF	Unterlegplatte	Schraube Unterlegplatte	Spannschraube	Schlüssel	
<b>SSSCR/L1212F09</b>	●	●	SCMW SCMT	09T3	12	12	80	15.2	12	13	—	—	TS43	TKY15F
<b>SSSCR/L1616H09</b>	●	●		09T3	16	16	100	15.2	16	17	—	—	TS43	TKY15F
<b>SSSCR/L2020K12</b>	●			1204	20	20	125	18	20	22	SPSSN42	JSS7	TS53	TKY25R
<b>SSSCR/L2525M12</b>	●			1204	25	25	150	25	25	27	SPSSN42	JSS7	TS53	TKY25R

\* Spannmoment (N • m) : TS43=3.5

Hinweis 1) Die Abbildungen der Wendeschneidplatten dienen nur als Beispiel. Die Buchstaben bezeichnen den Spanbrecher und die Abmessung bezieht sich auf den Innendurchmesser.

DREHEN

C

● : Lagerstandard.





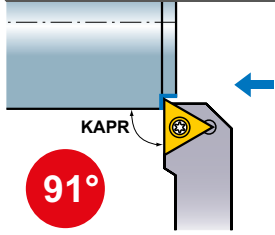

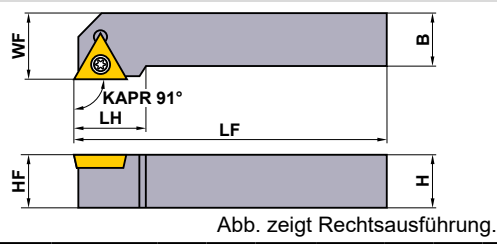

SSSC WSP > A155, A156  
SCHNITTDATENEMPFEHLUNGEN > A074, B020



## STGC



### Außendrehen **SP Ausführung**



Schichten	Leicht	Mittel	Rostfrei
FP  (11,16)	LP  (11,16)	MP  (11,13,16)	FM  (11,16)
Rostfrei	Rostfrei	Glatt	PKD/CBN
LM  (11,16)	MM  (11,13,16)	 (11,13,16)	 (11,13,16)

Bestellbezeichnung	Lager		WSP Bezeichnung	Abmessungen (mm)										
	R	L		H	B	LF	LH	HF	WF	Unterleg- platte	Schraube Unterlegplatte	Spannschraube	Schlüssel	
<b>STGCR/L1010E11</b>	●	●	TCGT TCMT TCGW TCMW	1102	10	10	70	13.5	10	12	—	—	TS25	TKY08F
<b>STGCR/L1212F13</b>	●	●		1303	12	12	80	17.6	12	16	—	—	TS3	TKY08F
<b>STGCR/L1616H16</b>	●	●		16T3	16	16	100	20.7	16	20	—	—	TS43	TKY15F
<b>STGCR/L2020K16</b>	●	●		16T3	20	20	125	22.9	20	25	SPSTN32	JSS6	TS406	TKY15R

\* Spannmoment (N • m) : TS25=1.0, TS3=1.0, TS43=3.5

# DREHEN





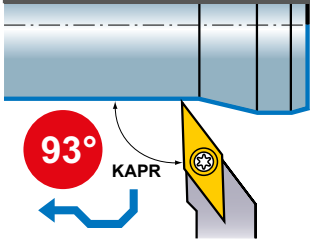

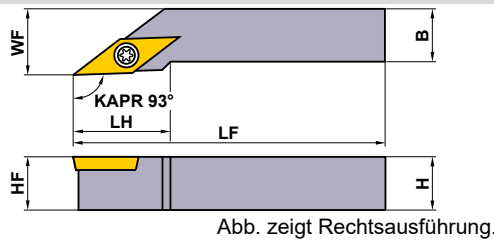

## VC WSP DREHHALTER



### SVJC



#### Außen-, Kopierdrehen **SP Ausführung**

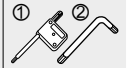

Schichten	Leicht	Mittel	Rostfrei
FP	LP	MP	FM
 (11,16)	 (11,16)	 (16)	 (11,16)
Rostfrei	Rostfrei	Mittel	Glatt
LM	MM	Standard	
 (11,16)	 (16)	 (11,16)	 (11,16)

Bestellbezeichnung	Lager		WSP Bezeichnung	Abmessungen (mm)										
	R	L		H	B	LF	LH	HF					WF	
<b>SVJCR/L1010E11</b>	●	●	VCGT VCGW VCMT VCMW	1103	10	10	70	17	10	12	—	—	TS25	⊙TKY08F
<b>SVJCR/L1616H16</b>	●	●		1604	16	16	100	25	16	20	—	—	TS43	⊙TKY15F
<b>SVJCR/L2020K16</b>	●	●		1604	20	20	125	40	20	25	SPSVN32	BCP141	TS44	⊙TKY15R
<b>SVJCR/L2525M16</b>	●	●		1604	25	25	150	40	25	32	SPSVN32	BCP141	TS44	⊙TKY15R

\* Spannmoment (N • m) : TS25=1.0, TS43=3.5, TS44=3.5

DREHEN



C

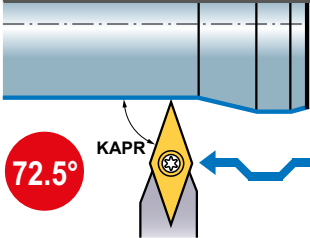

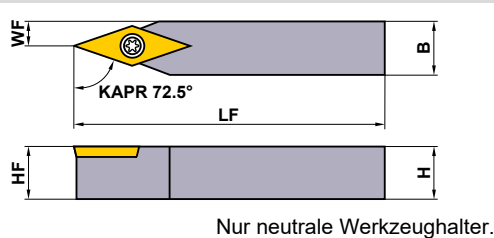

### SVVC

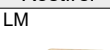
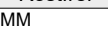
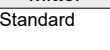

#### Außen-, Kopierdrehen **SP Ausführung**



Schichten	Leicht	Mittel	Rostfrei
FP	LP	MP	FM
 (16)	 (16)	 (16)	 (16)
Rostfrei	Rostfrei	Mittel	Glatt
LM	MM	Standard	
 (16)	 (16)	 (16)	 (16)

Bestellbezeichnung	Lager		WSP Bezeichnung	Abmessungen (mm)									
	R	L		H	B	LF	HF	WF					
<b>SVVCN1616H16</b>	●		VCGT VCGW VCMT VCMW	1604	16	16	100	16	8	—	—	TS43	⊙TKY15F
<b>SVVCN2020K16</b>	●			1604	20	20	125	20	10	SPSVN32	BCP141	TS44	⊙TKY15R
<b>SVVCN2525M16</b>	●			1604	25	25	150	25	12.5	SPSVN32	BCP141	TS44	⊙TKY15R

\* Spannmoment (N • m) : TS43=3.5, TS44=3.5

Hinweis 1) Die Abbildungen der Wendeschneidplatten dienen nur als Beispiel. Die Buchstaben bezeichnen den Spanbrecher und die Abmessung bezieht sich auf den Innenkreisdurchmesser.

● : Lagerstandard.

SVJC WSP > A167 – A169  
SVVC WSP > A167 – A169





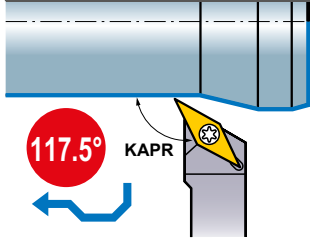

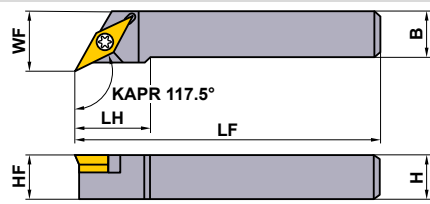

PCBN & PKD WSP > B060, B071  
SCHNITTDATENEMPFEHLUNGEN > A074, B020





# SVPC



## Plan-, Kopierdrehen **SP Ausführung**



Schichten	Leicht	Mittel	Rostfrei
FP	LP	MP	FM
 (16)	 (16)	 (16)	 (16)
Rostfrei	Rostfrei	Mittel	Glatt
LM	MM	Standard	
 (16)	 (16)	 (16)	 (16)

Bestellbezeichnung	Lager		WSP Bezeichnung	Abmessungen (mm)										
	R	L		H	B	LF	LH	HF	WF	Unterlegplatte	Befestigungs-feder	Spannschraube *	Schlüssel	
<b>SVPCR/L2020K16</b>	●	●	VCGT VCGW VCMT VCMW	1604	20	20	125	30	20	25	SPSVN32	BCP141	TS44	TKY15R
<b>SVPCR/L2525M16</b>	●	●	VCGT VCGW VCMT VCMW	1604	25	25	150	30	25	32	SPSVN32	BCP141	TS44	TKY15R

\* Spannmoment (N • m) : TS44=3.5

**DREHEN**

## SXZC

Außen-,  
Kopierdrehen

**PROFILHALTER**

Schichten  
SVX



Abb. zeigt Rechtsausführung.

Bestellbezeichnung	Lager		WSP Bezeichnung	Abmessungen (mm)						*						
	R	L		H	B	LF	LH	HF	WF	Spannschraube	Spannfinger	Spannfinger Schraube	Feder	WSP Schlüssel	Schlüssel (Spannfinger)	
<b>SXZCR/L1616H15</b>	●	●	XCMT	1503	16	16	100	35	16	20	TS255	AMS3	AJS3010T10	ASS2	TKY08F	TKY10F
<b>SXZCR/L2020K15</b>	●	●		1503	20	20	125	35	20	25	TS255	AMS3	AJS3010T10	ASS2	TKY08F	TKY10F
<b>SXZCR/L2525M15</b>	●	●		1503	25	25	150	40	25	32	TS255	AMS3	AJS3010T10	ASS2	TKF08F	TKF10F

\* Spannmoment (N • m) : TS255=1.0, AJS3010T10=2.5

DREHEN

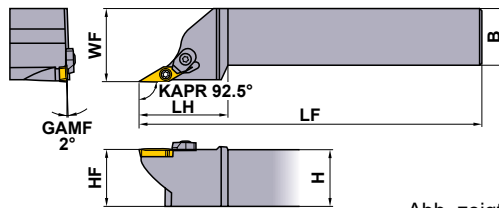
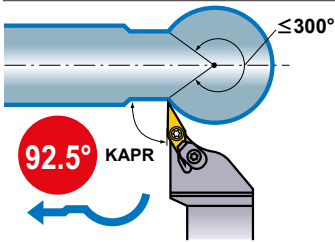
## ANWENDUNGSBEREICH

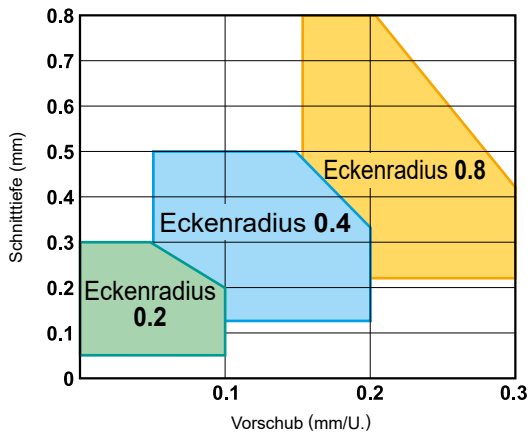

## SCHNITTDATENEMPFEHLUNGEN

	Material	Härte	Sorte	Schnittgeschw. (m/min)
<b>P</b>	Allg. Baustahl	≤180HB	<b>UE6020</b>	250 (150–350)
	C-Stahl, Leg. Stahl	150HB–250HB	<b>UE6020</b>	175 (100–250)
<b>M</b>	Rostfreier Stahl	≤200HB	<b>VP15TF</b>	100 (70–120)

Hinweis 1) Die oben angegebenen Schnittdaten sind allgemeine Ausgangsdaten.

Entsprechend den Maschinengegebenheiten, sowie Werkstückgeometrie und Werkstückklemmung müssen Anpassungen vorgenommen werden.

Hinweis 2) Die Abbildungen der Wendeschneidplatten dienen nur als Beispiel. Die Buchstaben bezeichnen den Spanbrecher und die Abmessung bezieht sich auf den Innenkreisdurchmesser.

● : Lagerstandard.

## HINWEIS

### Hinweise zum Kopieren der Stirnseite

Beim Ausdrehen der Stirnseite ist Folgendes zu beachten:

Tiefe von Stirnseite  
Bis 10mm

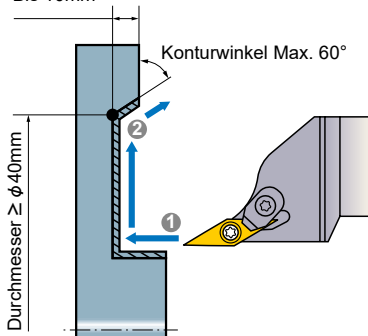

#### ● Bearbeiten eines Außendurchmessers (Schritt ①)

- Zur Verhinderung von Gratbildung sollte die Schnitttiefe geringer als der halbe Eckenradius sein.

#### ● Bearbeiten einer Fase (Schritt ②)

- Zur Reduzierung der Spankontaktlänge sollte die Schnitttiefe geringer als der halbe Eckenradius sein.
- Zur Verhinderung von Kollisionen zwischen Werkzeug und Werkstück sollten der Schnittdurchmesser mind. 40mm, der Konturwinkel max. 60° und die Tiefe von der Stirnseite max. 10mm betragen.

#### ● Schneidenwechsel

- Es wird empfohlen das Werkzeug neu zu vermessen, um die Bearbeitungspräzision zu sichern.

### Nicht möglich

#### ● Bearbeiten von Keilriemenscheiben

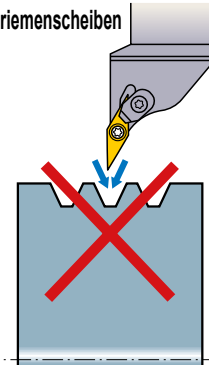

Beim Bearbeiten von Keilriemenscheiben ist eine VNMG-Schneidplatte zu verwenden.

C

DREHEN

# DREHEN [FÜR DIE ALUMINIUMBEARBEITUNG]

**DE** WSP  
DREHHALTER

## SDJE

Außen-,  
Kopierdrehen

**AL** Ausführung

Schichten

Mittel

R/L-F

R/L

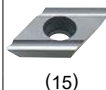
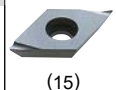

(15)

(15)

PKD

R/L-F



(15)

Abb. zeigt Rechtsausführung.

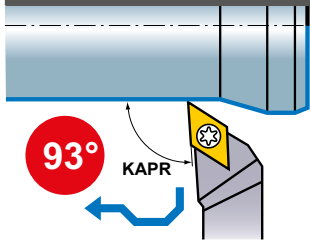

93°

KAPR

DREHEN

C

Bestellbezeichnung	Lager		WSP Bezeichnung	Abmessungen (mm)						* Spanschraube	* Schlüssel	
	R	L		H	B	LF	LH	HF	WF			
SDJER/L1616H15	●	●	DEGX	1504	16	16	100	27	16	20	CS451190T	TKY20F
SDJER/L2020K15	●	●		1504	20	20	125	35	20	25	CS451190T	TKY20F
SDJER/L2525M15	●	●		1504	25	25	150	35	25	32	CS451190T	TKY20F

\* Spannmoment (N • m) : CS451190T=5.0

## SDNE

Außen-,  
Kopierdrehen

**AL** Ausführung

Schichten

Mittel

R/L-F

R/L

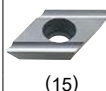
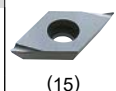

(15)

(15)

PKD

R/L-F



(15)

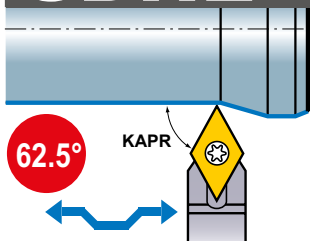

62.5°

KAPR

Bestellbezeichnung	Lager		WSP Bezeichnung	Abmessungen (mm)					* Spanschraube	* Schlüssel	
	R	L		H	B	LF	HF	WF			
SDNEN1616H15	●		DEGX	1504	16	16	100	16	8	CS451190T	TKY20F
SDNEN2020K15	●			1504	20	20	125	20	10	CS451190T	TKY20F
SDNEN2525M15	●			1504	25	25	150	25	12.5	CS451190T	TKY20F

\* Spannmoment (N • m) : CS451190T=5.0

## SCHNITTDATENEMPFEHLUNGEN

Material	Sorte	Schnittgeschw. (m/min)	Vorschub (mm/U.)	Schnitttiefe (mm)
N Aluminiumlegierung	HTi10	400	0.05-0.3	0.2-3.0
	MD220	800	0.05-0.3	0.2-0.5

Hinweis 1) Die Abbildungen der Wendschneidplatten dienen nur als Beispiel. Die Buchstaben bezeichnen den Spanbrecher und die Abmessung bezieht sich auf den Innenkreisdurchmesser.

● : Lagerstandard. ★ : Lagerstandard in Japan.

SDJE WSP > A153  
SDNE WSP > A153  
PKD WSP > B073

STGE		Außendreihen								AL Ausführung		Mittel	PKD
										R/L	R/L	(16)	(16)
Bestellbezeichnung	Lager	WSP Bezeichnung		Abmessungen (mm)					*				
	R L			H	B	LF	LH	HF	WF	Spannschraube	Schlüssel		
STGER/L1616H16	★ ★	TEGX	1603	16	16	100	22	16	20	FC400890T	TKY10F		
STGER/L2020K16	★ ★		1603	20	20	125	22	20	25	FC400890T	TKY10F		
STGER/L2525M16	★ ★		1603	25	25	150	22	25	32	FC400890T	TKY10F		

\* Spannmoment (N • m) : FC400890T=2.5

DREHEN

STFE		Plandrehen								AL Ausführung		Mittel	PKD
										R/L	R/L	(16)	(16)
Bestellbezeichnung	Lager	WSP Bezeichnung		Abmessungen (mm)					*				
	R L			H	B	LF	LH	HF	WF	Spannschraube	Schlüssel		
STFER/L1616H16	★ ★	TEGX	1603	16	16	100	22	16	20	FC400890T	TKY10F		
STFER/L2020K16	★ ★		1603	20	20	125	22	20	25	FC400890T	TKY10F		
STFER/L2525M16	★ ★		1603	25	25	150	22	25	32	FC400890T	TKY10F		

Hinweis 1) Bei Verwendung von linken und rechten Spanbrechern, verwenden Sie bitte rechte WSP mit linken Haltern und linke WSP mit rechten Haltern.

\* Spannmoment (N • m) : FC400890T=2.5

## SCHNITTDATENEMPFEHLUNGEN

Material	Sorte	Schnittgeschw. (m/min)	Vorschub (mm/U.)	Schnitttiefe (mm)
N Aluminiumlegierung	HTi10	400	0.05–0.3	0.2–3.0
	MD220	800	0.05–0.3	0.2–0.5

STGE WSP > A161  
 STFE WSP > A161  
 PKD WSP > B073

ERSATZTEILE > N001  
 TECHNISCHE DATEN > P001



# DREHEN [FÜR DIE ALUMINIUMBEARBEITUNG]

**VD** WSP  
DREHHALTER

**SVJD**

Außen-,  
Kopierdrehen

**AL Ausführung**

Schichten  
R/L



Abb. zeigt Rechtsausführung.



Bestellbezeichnung	Lager		WSP Bezeichnung	Abmessungen (mm)						*		
	R	L		H	B	LF	LH	HF	WF	Spanschraube	Schlüssel	
<b>SVJDR/L1616H16</b>	★	★	VDGX	1603	16	16	100	30	16	20	FC400890T	TKY10F
<b>SVJDR/L2020K16</b>	★	★		1603	20	20	125	30	20	25	FC400890T	TKY10F
<b>SVJDR/L2525M16</b>	★	★		1603	25	25	150	30	25	32	FC400890T	TKY10F

\* Spannmoment (N • m) : FC400890T=2.5

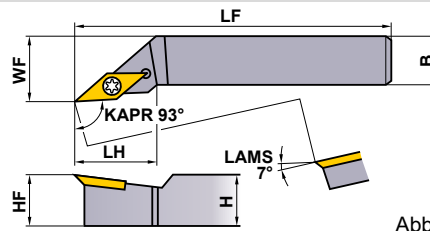
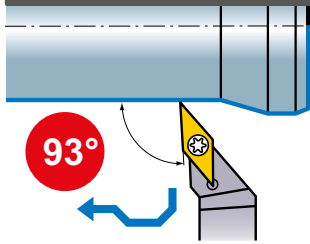
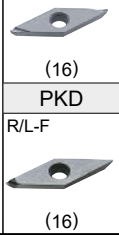
DREHEN

## SCHNITTDATENEMPFEHLUNGEN

Material	Sorte	Schnittgeschw. (m/min)	Vorschub (mm/U.)	Schnitttiefe (mm)
N Aluminiumlegierung	HTi10	400	0.05–0.3	0.2–3.0
	MD220	800	0.05–0.3	0.2–0.5

Hinweis 1) Die Abbildungen der Wendeschneidplatten dienen nur als Beispiel. Die Buchstaben bezeichnen den Spanbrecher und die Abmessung bezieht sich auf den Innenkreisdurchmesser.

● : Lagerstandard. ★ : Lagerstandard in Japan.

SVJD WSP > A170  
PKD WSP > B074

# TL HALTER

## HALTER

Abbildung	Neue Bestellbezeichnung	Alte Bestellbezeichnung	Lager	WSP Bezeichnung	Abmessungen (mm)					
					IC	H	B	HF	LF	LH
<b>TLHR</b> (Außen-, Kopierdrehen) 	<b>TLHR2020K5</b>	TLHR2020K5	●	RTG05A	5	20	20	20	125	16
	<b>TLHR2020K6</b>	TLHR2020K6	●	RTG06A	6	20	20	20	125	16
	<b>TLHR2525M7</b>	TLHR2525M7	●	RTG07A	7	25	25	25	150	20
	<b>TLHR3225P10</b>	TLHR54P10	●	RTG10A	10	32	25	32	170	25

## WSP

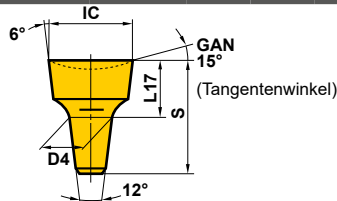

Bestellbezeichnung	Lager		Abmessungen (mm)			
	Hartmetall		IC	S	D4	L17
	UTi20T	HTi10				
<b>RTG05A</b>	●	●	5	7.5	2.5	3.5
<b>RTG06A</b>	●	●	6	7.5	3.5	3.5
<b>RTG07A</b>	●		7	11	3.5	5
<b>RTG08A</b>	●	●	8	11	4.5	5
<b>RTG10A</b>	●	●	10	14	5.5	6.5

## PLATTENSITZ

Bei Herstellung eigener Sonderwerkzeughalter muss der Plattensitz laut Zeichnung fixiert werden.

Plattensitzabmessung	WSP Durchmesser IC	Abmessungen (mm)					Kegeldurchmesser
		h	d1	d2	l1	l2	
	5	4	2.5	1.9	1.85	3.2	1.5
	6	4	3.5	2.9	2.35	3.7	2.5
	7	6	3.5	2.5	2.75	4.3	2.1
	8	6	4.5	3.5	3.25	4.8	3.1
	10	7.5	5.5	4.2	4.15	5.9	3.8
	12	7.5	7.5	6.2	5.15	6.9	5.8

# Notizen

---

A series of horizontal dashed lines for taking notes, spanning the width of the page.

# Notizen

---

A series of horizontal dashed lines for writing notes.

# ALLGEMEINE ERKLÄRUNG: DREHEN SMALL TOOLS

## ● Wie sind die Seiten dieses Kapitels aufgebaut

- 1) Untergruppen aufgeteilt nach Produkt Serien und Bearbeitungsmethoden. (Beachten Sie das Inhaltsverzeichnis auf der nächsten Seite.)
- 2) Bearbeitungsmethoden wie Außendrehen → Außen Einstechen → Gewindedrehen → Ausdrehen.

**AUSFÜHRUNG DES DREHHALTERS**  
Die ersten vier Buchstaben der Bestellbezeichnung, sowie der Anwendungsbereich werden aufgelistet.

**ANWENDUNG**

**PRODUKT KAPITEL**

**ABBILDUNG ZEIGT DEN ANWENDUNGSBEREICH**  
Die Abbildungen und Bearbeitungspfeile beschreiben die möglichen Bearbeitungsarten, sowie den Anstellwinkel.

**ABBILDUNG SPANBRECHER ÜBERSICHT**

**SMALL TOOLS**

### AUSSEN LÄNGSDREHEN

#### SCAC-SM

Nicht abgesetzt

Bestellbezeichnung	WSP Bezeichnung	Abmessungen (mm)										Spannweite	Schlüssel	
		H	B	LF	LH	HBKW	HF	WF2	LF	LF	LF			
SCACRL0909K06-SM	090200	8	8	125	11	1,6	8	0	TS254	TKY09R				
SCACRL1010K06-SM	090200	10	10	125	—	—	10	0	TS254	TKY09R				
SCACRL1010K09-SM	090200	10	10	125	16	3,5	10	0	TS43	TKY15R				
SCACRL1212M09-SM	090200	12	12	150	14	1,5	12	0	TS43	TKY15R				
SCACRL1616M09-SM	090200	16	16	150	—	—	16	0	TS43	TKY15R				

\* Spannmoment (N·m) : TS254=1,0, TS43=3,5

#### SCLC-SM

Nicht abgesetzt

Bestellbezeichnung	WSP Bezeichnung	Abmessungen (mm)										Spannweite	Schlüssel
		H	B	LF	LH	HBKW	HF	WF2	LF	LF	LF		
SCLCRL0909K06-SM	090200	8	8	125	11	2,1	8	0	TS254	TKY09R			
SCLCRL1010K06-SM	090200	10	10	125	—	—	10	0	TS254	TKY09R			
SCLCRL1010K09-SM	090200	10	10	125	20	4	10	0	TS43	TKY15R			
SCLCRL1212M09-SM	090200	12	12	150	18	2	12	0	TS43	TKY15R			
SCLCRL1616M09-SM	090200	16	16	150	—	—	16	0	TS43	TKY15R			

\* Spannmoment (N·m) : TS254=1,0, TS43=3,5

#### SDJC-SM

Nicht abgesetzt

Bestellbezeichnung	WSP Bezeichnung	Abmessungen (mm)										Spannweite	Schlüssel
		H	B	LF	LH	HBKW	HF	WF2	LF	LF	LF		
SDJCLR0909K07-SM	070200	8	8	125	16	2	8	0	TS254	TKY09R			
SDJCLR1010K07-SM	070200	10	10	125	—	—	10	0	TS254	TKY09R			
SDJCLR1010K11-SM	110200	10	10	125	24	4	10	0	TS43	TKY15R			
SDJCLR1212M11-SM	110200	12	12	150	22	2	12	0	TS43	TKY15R			
SDJCLR1616M11-SM	110200	16	16	150	—	—	16	0	TS43	TKY15R			

\* Spannmoment (N·m) : TS254=1,0, TS43=3,5

#### SDNC-SM

Neutraler WSP-Halter  
Nicht abgesetzt

Bestellbezeichnung	WSP Bezeichnung	Abmessungen (mm)										Spannweite	Schlüssel
		H	B	LF	LH	HBKW	HF	WF2	LF	LF	LF		
SDNCLR0909K07-SM	070200	8	8	125	—	—	8	3	TS254	TKY09R			
SDNCLR1010K07-SM	070200	10	10	125	—	—	10	3	TS254	TKY09R			
SDNCLR1010K11-SM	110200	10	10	125	24	2	10	5	TS43	TKY15R			
SDNCLR1212M11-SM	110200	12	12	150	—	—	12	5	TS43	TKY15R			
SDNCLR1616M11-SM	110200	16	16	150	—	—	16	5	TS43	TKY15R			

\* Spannmoment (N·m) : TS254=1,0, TS43=3,5

**SCHNITTDATENEMPFEHLUNG**

Werkstoff	Härte	Sorte	Schnittgeschw. (m/min)	Vorschub (mm/U)
P C-Stahl, Leg. Stahl	180HB-280HB	MS6015/VP15TF	100 (50-150)	0,08 (0,01-0,15)
		MS6015	110 (30-180)	0,08 (0,01-0,15)
		NX2555	150 (50-250)	0,08 (0,01-0,15)
M Allg. Baustahl	—	VP15TF/MP9005/MP9015	80 (50-120)	0,08 (0,02-0,1)
		MS9025	100 (50-180)	0,08 (0,01-0,15)
N Aluminium Leg.	—	HT10/MT9005	150 (70-230)	0,09 (0,03-0,15)
		MT9005	60 (40-80)	0,08 (0,04-0,12)
S Hitzebeständiger Stahl	—	MP9015/MS9025	50 (20-75)	0,08 (0,04-0,12)

Hinweis 1) Die Abbildungen der Wendeschneidplatten dienen nur als Beispiel. Die Buchstaben bezeichnen den Spanbrecher, und die Abmessung bezieht sich auf den Innendurchmesser.  
Hinweis 2) Abmessungen für WSP-Schneidplatte NE 0,2 gezeigt.

● : Lagerstandard. \* : Lagerstandard in Japan.

**LEGENDE FÜR LAGERSYMBOL**  
Wird auf jeder Doppelseite auf der linken Seite gezeigt.

**STANDARDPRODUKTE**  
Listet Bestellbezeichnung, Lagerstatus (Rechts/Links), Abmessungen, verfügbare WSP und Ersatzteile auf.

**QUERVERWEISE / VERFÜGBARE WSP**  
Weist auf weitere detaillierte Produktinformationen hin.

**QUERVERWEIS AUF ANDERE SEITEN**  
·ERSATZTEILE  
·TECHNISCHE DATEN  
Beinhaltet Querverweise für alle auf dieser Doppelseite aufgeführten Produkte.

**SCHNITTDATENEMPFEHLUNGEN**  
Für jeden Werkstoff werden allgemeine Schnittdatenempfehlungen gemäß der ISO-Klassifizierung nach P, M, K und N angegeben.

# DREHEN

# SMALL TOOLS

GESAMTÜBERSICHT DER SMALL TOOLS.....	D002
KLASSIFIKATION.....	D006

## STANDARDWERKZEUGE FÜR DIE PRÄZISIONSBEARBEITUNG

### AUSSEN LÄNGSDREHEN

SCAC-SM.....	D010
SCLC-SM.....	D010
SDJC-SM.....	D011
SDNC-SM.....	D011
SVLP-SM.....	D012
SVJB-SM.....	D012
SVJC-SM.....	D013
SVPP-SM.....	D013
SVVB-SM.....	D013

### AUSSEN RÜCKWÄRTSDREHEN

BTAH.....	D014
CTBH.....	D015
BTVH.....	D016

### AUSSEN EINSTECHEN

GTAH.....	D018
GTBH.....	D018
GTCH.....	D018

### AUSSEN ABSTECHEN

CTAH.....	D020
CTAH-S.....	D020
CTBH.....	D022

### AUSSENGEWINDE DREHEN

TTAH.....	D024
-----------	------

### AUSSEN LÄNGSDREHEN, KOPIEREN, PLANDREHEN

SH.....	D026
---------	------

#### \*Alphabetisches Inhaltsverzeichnis

D014 BTAH	D018 GTAH	D012 SVJB-SM
D014 BTAT (WSP)	D018 GTAT (WSP)	D013 SVJC-SM
D015 BTBT (WSP)	D018 GTBH	D012 SVLP-SM
D016 BTVH	D018 GTBT (WSP)	D013 SVPP-SM
D016 BTVT (WSP)	D018 GTCH	D013 SVVB-SM
D020 CTAH	D018 GTCT (WSP)	D024 TTAH
D020 CTAH-S	D010 SCAC-SM	D024 TTAT (WSP)
D021 CTAT (WSP)	D010 SCLC-SM	
D015 CTBH	D011 SDJC-SM	
D022 CTBT (WSP)	D011 SDNC-SM	

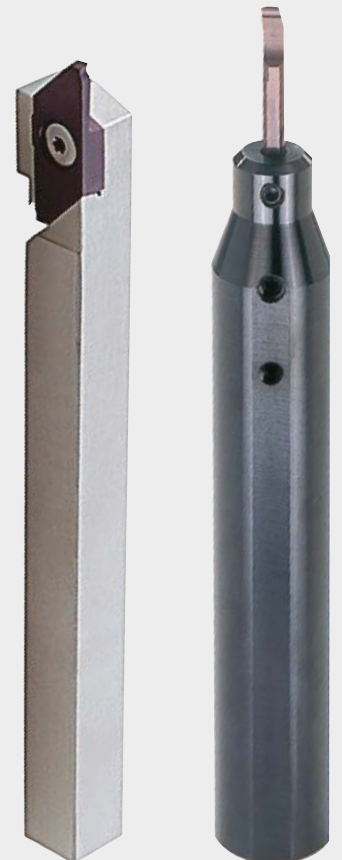

# GESAMTÜBERSICHT DER SMALL TOOLS

WERKZEUGE FÜR DAS AUSSENDREHEN, ABSTECHEN UND GEWINDEDREHEN

SMALL TOOLS

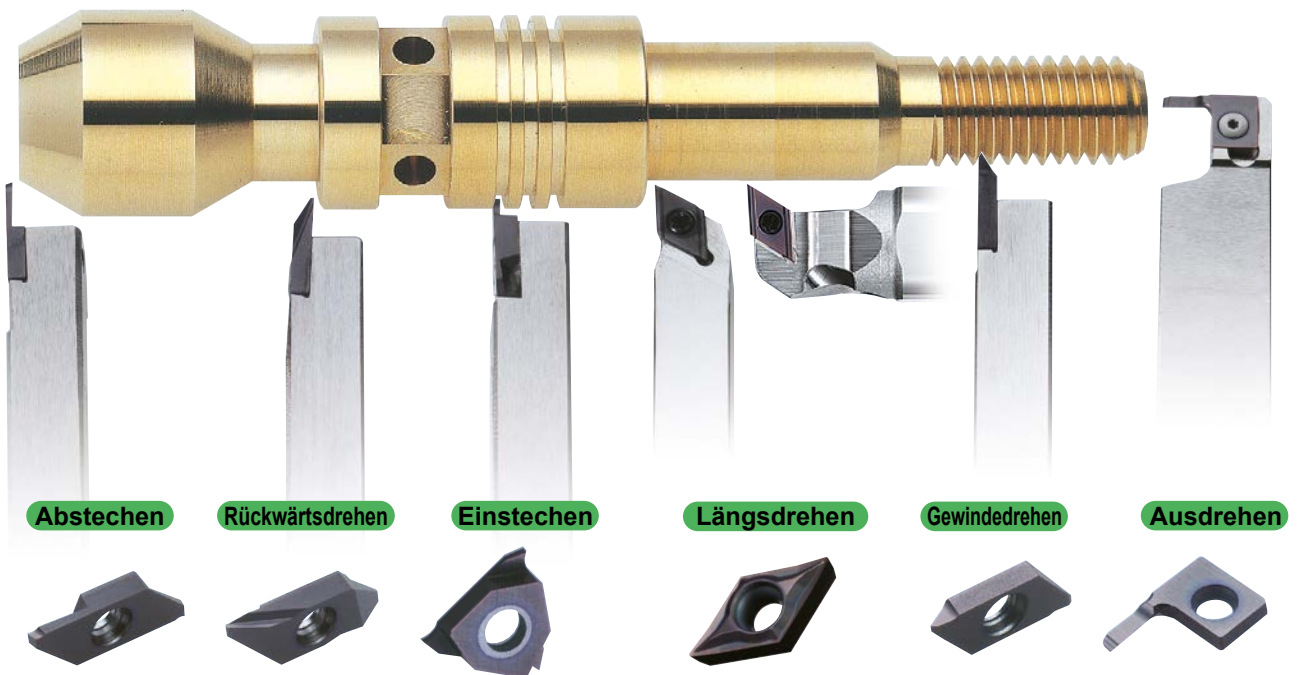

PVD-beschichtete Hartmetallsorte für Kohlenstoffstähle

## MS6015

Optimal zum Drehen von reinem Eisen-, Kohlenstoff- und Automatenstählen, sowie zum Erzielen hoher Oberflächengüten und präziser Maßhaltigkeit.

	MS6015	Herkömmlich
Beschichtung	TiCN Multilayer	TiAlN
Härte (HV)	3,000	2,800
Verschleißkoeffizient (Kohlenstoffstahl)	Low	High
Härte des Substrats (HRA)	92.0	92.0
T.R.S (GPa)	2.0	2.0

Multilayer-Beschichtung Ti-C-N

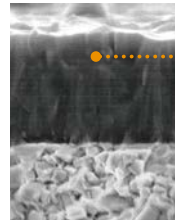

Hervorragender Verschleißwiderstand und Vermeidung von Aufbauschneidbildung für beste Ergebnisse bei der Bearbeitung von Kohlenstoffstahl.

PVD-beschichtete Hartmetallsorte für Präzisions- und Kleinteilbearbeitung

## MS9025 NEW

Effektive Reduzierung des Kerbverschleißes mit ausgewogener Balance zwischen Verschleißfestigkeit und Bruchwiderstand.

### Verbessertes Hartmetallsubstrat

Die Wärmeleitfähigkeit wurde durch eine optimierte Korngröße verbessert, die wiederum den Grenzkontakt zwischen den WC-Partikeln verringert. Diese Optimierung senkt die Schneidentemperatur während der Bearbeitung.

#### MS9025

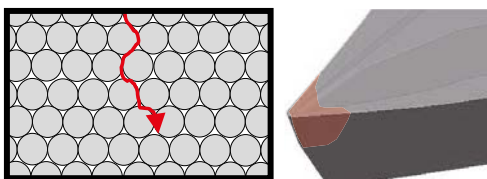

Geringere Schneidkantentemperaturen dank der verbesserten Wärmeleitfähigkeit.

#### Herkömmliches Produkt

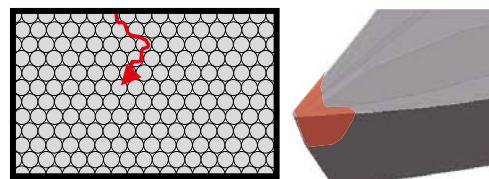

Höhere Schneidkantentemperaturen durch größeren Grenzkontakt der Partikel.

● Gesinterter Spanbrecher

Schneidenradien mit Minustoleranz ausgeführt

- Bestens geeignet für die Kleinteilebearbeitung, welche häufig Minustoleranzen erfordern.
- Die Bestellnummer ist mit dem Buchstaben "M" markiert, als Zeichen für Minustoleranz. Beispiel: DCGT11T301M-FS
- Der Eckenradius ist zur besseren Erkennbarkeit an der Seite des Schneidplattenetiketts aufgedruckt.

Kombination aus geschwungener Schneidkante und hervorstehendem Spanbrecher für effizienten Spanbruch.

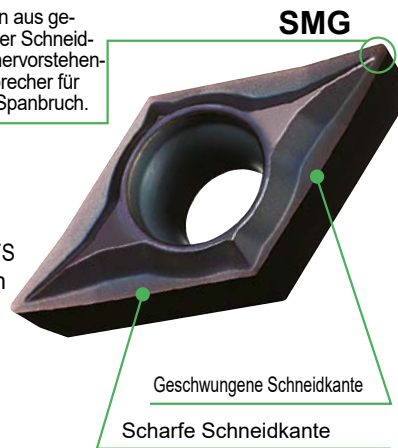

FS

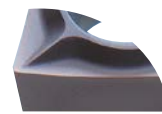

FS-P



LS

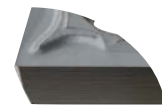

LS-P



● Radiustoleranz



E-Toleranz  
RE  $\begin{smallmatrix} 0 \\ -0.02 \end{smallmatrix}$  mm

Artikelbezeichnungen mit "M"

RE  $\begin{smallmatrix} 0 \\ -0.05 \end{smallmatrix}$  mm

(Konventionelle WSP, G-Toleranz)  
RE  $\pm 0.10$  mm

● Abstechen

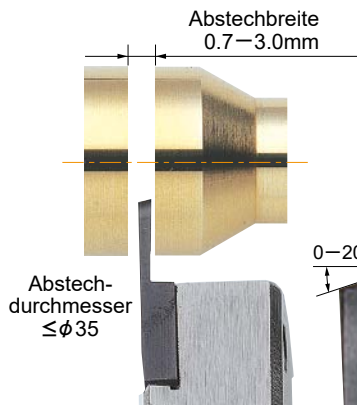

● Hinterdrehen



● Gewindedrehen



● Mechanismus zur WSP Klemmung  
(Kann direkt in der Maschine gewechselt werden)

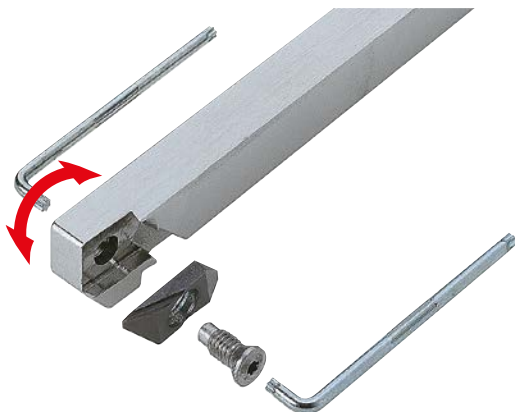

Spezielle Klemmschraube zur Klemmung

● Einstechen

- 3-schneidig
- Stechbreite 0.3—3.0mm
- Seitliches Verfahren ist möglich

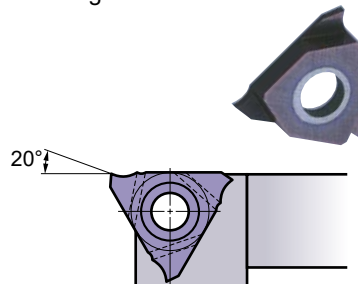

● Längsdrehen

- E-Toleranz WSP
- Große Auswahl an Wendeschneidplatten mit kleinem Eckenradius
- 30° Freiwinkel

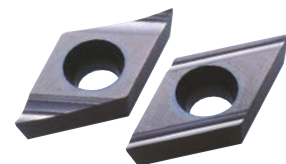



## Werkzeuge für einen breiten Einsatzbereich in der Kleinteilfertigung

Außendrehen	Werkzeuge für das Längsdrehen, Kopierdrehen, Profildrehen, Abstechen, Rückwärtsdrehen und Gewindedrehen von Kleinteilen.
Innendrehen	Werkzeuge für das interne Plandrehen und Gewindedrehen von Kleinteilen.
Bohren	Spezielle VHM Bohrer mit oder ohne Innenkühlung im Durchmesserbereich $\phi 0.1 - 3.0\text{mm}$ sind standardmäßig lieferbar.
Schaftfräser	VHM Schaft-, Kugelkopf-, Nuten- sowie Torusfräser sind in einer Vielzahl von Ausführungen lieferbar.

## Präzisions-WSP für produktive Bearbeitungen

Hohe Qualität	E-Toleranz, scharfe Schneidkante, hochpräziser kleiner Eckenradius, glatte Oberflächengüte
Sorten	PVD-Beschichtung MS6015/VP15TF/MP9005/MP9015
Hohe Effizienz	Ein Nachschleifen der Werkzeuge ist dank austauschbarer Platten nicht notwendig.

## Werkzeuge für die Kleinteilfertigung

Werkzeughalter	Halter für radiale, axiale, abgewinkelte und gerade Montage.
Haltergrößen	Quadratischer Schaft : 8–16mm Zylinderschaft : unter $\phi 25.4\text{mm}$



## WERKZEUGE FÜR DIE KLEINTEILFERTIGUNG

- Schaftwerkzeuge für Multi-Task-Bearbeitungen (z.B. Mini-Revolver und Linearschlitten).
- Für die Bearbeitung von Werkstücken mit kleinem Durchmesser (5mm und kleiner).
- Halter für Längsdrehen, Einstechen, Abstechen, Rückwärtsdrehen sowie Gewindedrehen.

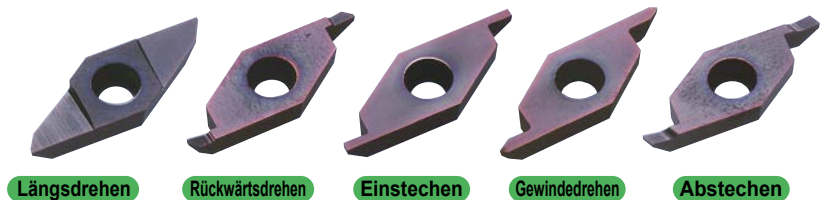

## WERKZEUGE FÜR DIE INNENBEARBEITUNG

### Vollhartmetall **MICRO-MINI TWIN Bohrstangen**

Min. Durchmesser  $\phi 2.2$ –

Ausdrehen  
Einstechen  
Gewindedrehen



Zylinderschaft

Vierkantschaft

## MICRO-DEX Bohrstangen

Min. Durchmesser  
 $\phi 5.0$ –

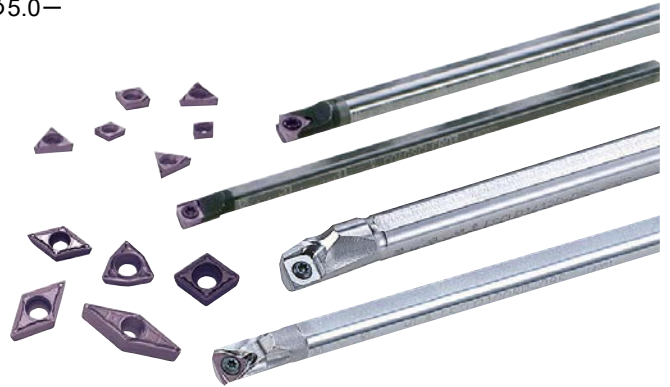

Min. Durchmesser  
 $\phi 10.0$

## DIMPLE BAR

(Weitere Informationen zu diesen Werkzeugen im Kapitel Bohrstangen.)

## WERKZEUGE FÜR DAS BOHREN

Violett beschichteter Präzisionsbohrer

**VAPDS/VAPDM** (Teilprofil)  
(Für rostfreien Stahl)

**VAPDSB**  
(Für das Anbohren)

Bohrer aus Vollhartmetall

**MVS/DWAE**

Vollhartmetall-Flachbodenbohrer

**MFE**

Vollhartmetallbohrer zum  
Zentrieren und Anfasen

**DLE**



Mikro-Vollhartmetallbohrer

**MSE**-Bohrer

**MSE/MSP** (Zentrierbohrer)



Vollhartmetall-Tieflochbohrer

Mikro-Vollhartmetall-Einlippenbohrer  
mit durchgehenden Kühlkanalbohrungen

**MGS**



## WERKZEUGE FÜR DAS FRÄSEN

Schaftfräser aus Vollhartmetall

**MSTAR / MSTAR Plus** VHM-Schaftfräserserie



Vibrationsreduzierte

Vollhartmetallfräser zur Bearbeitung  
schwer zerspanbarer Materialien

**SMART MIRACLE** VHM-Schaftfräserserie



D

SMALL TOOLS

# KLASSIFIKATION

## WERKZEUGE FÜR MEHRSPINDELAUTOMATEN

### ● LÄNGSDREHEN

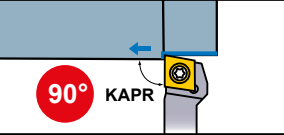
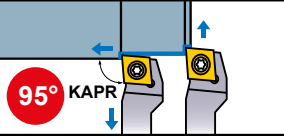
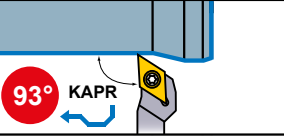
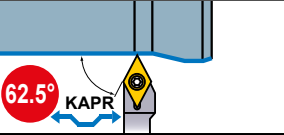
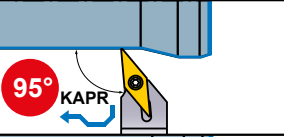
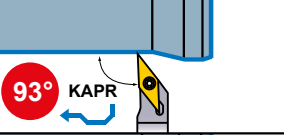
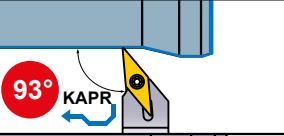
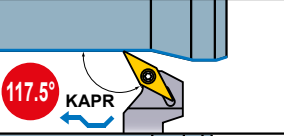
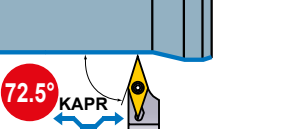
Halter-bezeichnung	Schaftgröße (mm) (H x W x L)	Abbildung
<b>SCAC-SM</b> ↻ D010	8 x 8 x 125 10 x 10 x 125 12 x 12 x 150 16 x 16 x 150	
<b>SCLC-SM</b> ↻ D010	8 x 8 x 125 10 x 10 x 125 12 x 12 x 150 16 x 16 x 150	
<b>SDJC-SM</b> ↻ D011	8 x 8 x 125 10 x 10 x 125 12 x 12 x 150 16 x 16 x 150	
<b>SDNC-SM</b> ↻ D011	8 x 8 x 125 10 x 10 x 125 12 x 12 x 150 16 x 16 x 150	
<b>SVLP-SM</b> ↻ D012	10 x 10 x 125 12 x 12 x 150 16 x 16 x 150	
<b>SVJB-SM</b> ↻ D012	10 x 10 x 125 12 x 12 x 150 16 x 16 x 150	
<b>SVJC-SM</b> ↻ D013	10 x 10 x 120 12 x 12 x 120 16 x 16 x 120	
<b>SVPP-SM</b> ↻ D013	10 x 10 x 125 12 x 12 x 150 16 x 16 x 150	
<b>SVVB-SM</b> ↻ D013	10 x 10 x 125 12 x 12 x 150 16 x 16 x 150	

### ● RÜCKWÄRTSDREHEN

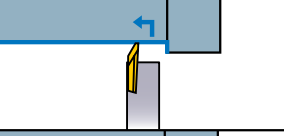
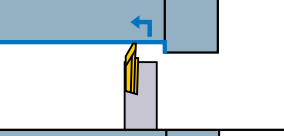
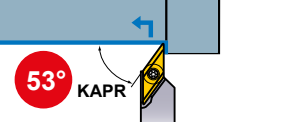
Halter-bezeichnung	Schaftgröße (mm) (H x W x L)	Abbildung
<b>BTAH</b> (WSP-Größe 2.8,3.5,5.0mm) ↻ D014	8 x 10 x 120 10 x 10 x 120 12 x 12 x 120 16 x 16 x 120	
<b>CTBH</b> (WSP-Größe 4.5,6.0mm) ↻ D015	10 x 10 x 120 12 x 12 x 120 16 x 16 x 120	
<b>BTVH</b> (WSP-Größe 7.5mm) ↻ D016	10 x 10 x 120 12 x 12 x 120 16 x 16 x 120	

### ● GEWINDEDREHEN

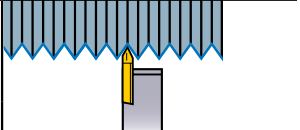
Halter-bezeichnung	Schaftgröße (mm) (H x W x L)	Abbildung
<b>TTAH</b> ↻ D024	8 x 10 x 120 10 x 10 x 120 12 x 12 x 120 16 x 16 x 120	

### ● EINSTECHEN

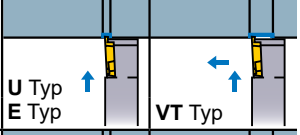
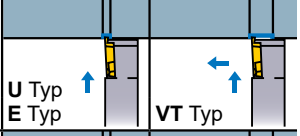
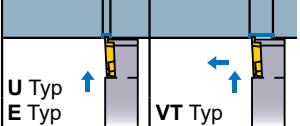
Halter-bezeichnung	Schaftgröße (mm) (H x W x L)	Abbildung
<b>GTAH</b> (Schnittbreite 0.3–3.0mm) ↻ D018	8 x 8 x 80 8 x 8 x 120 10 x 10 x 80 10 x 10 x 120 12 x 12 x 80 12 x 12 x 120 16 x 16 x 120	
<b>GTBH</b> (Schnittbreite 1.45–3.0mm) ↻ D018	10 x 10 x 80 10 x 10 x 120 12 x 12 x 120 16 x 16 x 120	
<b>GTCH</b> (Schnittbreite 2.5–3.0mm) ↻ D018	10 x 10 x 80 10 x 10 x 120	

### ● ABSTECHEN

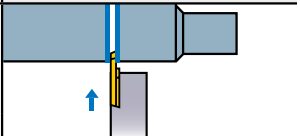
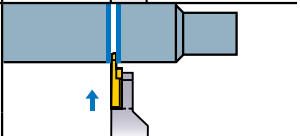
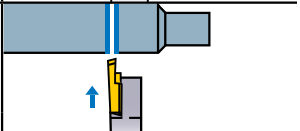
Halter-bezeichnung	Schaftgröße (mm) (H x W x L)	Abbildung
<b>CTAH</b> (Max. Abstechedurchm. 12mm) ↻ D020	8 x 10 x 120 10 x 10 x 120 12 x 12 x 120 16 x 16 x 120	
<b>CTAH-S</b> (Max. Abstechedurchm. 12mm) ↻ D020	10 x 10 x 80	
<b>CTBH</b> (Max. Abstechedurchm. 16mm) ↻ D022	10 x 10 x 120 12 x 12 x 120 16 x 16 x 120	

## FÜR LANGDREHAUTOMATEN

### ● DIMPLE BAR DREHHALTER

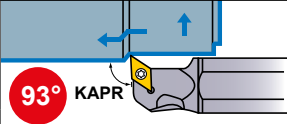

Halter-bezeichnung	Schaftgröße (mm) (Schaft Durchm. x L)	Abbildung
<b>SH</b> (Längsdrehen, Kopieren, Plandrehen) ↪ D026	$\phi 15.875 \times 100$ $\phi 19.05 \times 125$ $\phi 20 \times 125$ $\phi 22 \times 125$ $\phi 25.4 \times 150$	 93° KAPR

### ● GEWINDEDREHEN

Halter-bezeichnung	Schaftgröße (mm) (H x W x L)	Abbildung
<b>MMT</b> ↪ G019	$12 \times 12 \times 100$ $16 \times 16 \times 100$ $20 \times 20 \times 125$ $25 \times 25 \times 150$ $32 \times 32 \times 170$	

## WERKZEUGE FÜR REVOLVERMASCHINEN

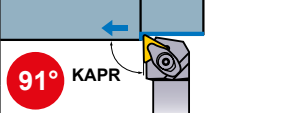
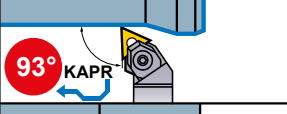
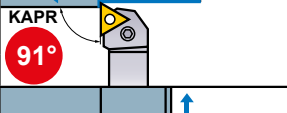
### ● LÄNGSDREHEN

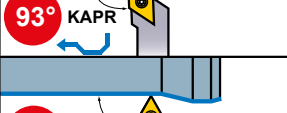
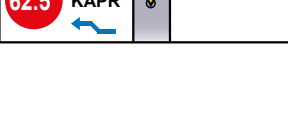
Halter-bezeichnung	Schaftgröße (mm) (H x W x L)	Abbildung
<b>DTGN</b> ↪ C016	$16 \times 16 \times 100$ $20 \times 20 \times 125$ $25 \times 25 \times 150$	 91° KAPR
<b>MTJN</b> ↪ C017	$20 \times 20 \times 125$ $25 \times 25 \times 150$	 93° KAPR
<b>PTGN</b> ↪ C016	$10 \times 10 \times 70$ $12 \times 12 \times 80$ $16 \times 16 \times 100$ $20 \times 20 \times 125$ $25 \times 25 \times 150$	 KAPR 91°
<b>SCLC</b> ↪ C024	$8 \times 8 \times 60$ $10 \times 10 \times 70$ $12 \times 12 \times 80$ $16 \times 16 \times 100$	 95° KAPR
<b>SDJC</b> ↪ C025	$10 \times 10 \times 70$ $12 \times 12 \times 80$ $16 \times 16 \times 100$	 93° KAPR
<b>SDNC</b> ↪ C025	$8 \times 8 \times 60$ $10 \times 10 \times 70$ $12 \times 12 \times 80$ $16 \times 16 \times 100$	 62.5° KAPR

# KLASSIFIZIERUNG DER INNENDREHWERKZEUGE (FÜR ALLGEMEINE BEARBEITUNGEN)

D  
SMALL TOOLS

Produktbezeichnung	Halter
<b>MICRO-MINI TWIN</b> Bohrstangen (Vollhartmetall) E021, E022	<b>CB CR</b>  Min. Durchmesser : 2.2mm
<b>MICRO-MINI</b> Bohrstangen (Vollhartmetall) E024	<b>COFR-BLS</b>  Min. Durchmesser : 3.2mm
<b>MICRO-DEX</b> Bohrstangen (Hartmetallschaft) E018	<b>SCLC</b>  Min. Durchmesser : 5mm
<b>MICRO-DEX</b> Bohrstangen (Hartmetallschaft) E019	<b>STUC</b>  Min. Durchmesser : 8mm
<b>MICRO-DEX</b> Bohrstangen (Hartmetallschaft) E018	<b>SWUB</b>  Min. Durchmesser : 6mm
<b>F-Ausführung</b> Bohrstangen (Stahlschaft) E029	<b>FSWL1</b>  Min. Durchmesser : 5.8mm
<b>F-Ausführung</b> Bohrstangen (Hartmetallschaft) E029	<b>FSWL2</b>  Min. Durchmesser : 5.8mm
<b>DIMPLE BAR</b> (Stahlschaft) (Hartmetallschaft) E007, E008	<b>FSCLC/P FSCLC/P-E</b>  Min. Durchmesser : 10mm

Produktbezeichnung	Halter
<b>DIMPLE BAR</b> (Stahlschaft) (Hartmetallschaft) E010	<b>FSDUC FSDUC-E</b>  Min. Durchmesser : 14mm
<b>DIMPLE BAR</b> (Stahlschaft) (Hartmetallschaft) E011	<b>FSDQC FSDQC-E</b>  Min. Durchmesser : 13mm
<b>DIMPLE BAR</b> (Stahlschaft) (Hartmetallschaft) E009	<b>FSTUP FSTUP-E</b>  Min. Durchmesser : 10mm
<b>DIMPLE BAR</b> (Stahlschaft) E013	<b>FSVUB/C</b>  Min. Durchmesser : 16mm
<b>DIMPLE BAR</b> (Stahlschaft) E013	<b>FSVPB/C</b>  Min. Durchmesser : 16mm
<b>DIMPLE BAR</b> (Stahlschaft) E014	<b>FSVJB/C</b>  Min. Durchmesser : 16mm
<b>DIMPLE BAR</b> (Stahlschaft) (Hartmetallschaft) E012	<b>FSWUB/P FSWUB/P-E</b>  Min. Durchmesser : 10mm

# KLASSIFIZIERUNG DER INNENDREHWERKZEUGE (EINSTECHEN/GEWINDEDREHEN) (SCHAFTFRÄSER/BOHREN)

## FÜR EINSTECHEN UND GEWINDEDREHEN

Produktbezeichnung	Halter
<b>MICRO-MINI TWIN Bohrstangen</b> (Vollhartmetall) ➔ F127	<b>CG Ausführung (Einstechen)</b>  Min. Durchmesser : 3mm
<b>MICRO-MINI TWIN Bohrstangen</b> (Vollhartmetall) ➔ G031	<b>CT Ausführung (Gewindedrehen)</b>  Min. Durchmesser : 3mm

## SCHAFTFRÄSER

Schaftfräser aus Vollhartmetall	➔ I026
Schaftfräser aus HSS	➔ I034

## BOHREN

Produktbezeichnung	Hartmetallbohrer
<b>Bohrer aus Vollhartmetall</b> ➔ M036	<b>MVS-Serie</b> 
<b>Bohrer aus Vollhartmetall</b> ➔ M020	<b>DWAE-Serie</b> 
<b>Führende Bohrerreihe</b> ➔ M012	<b>DLE-Serie</b> 
<b>Flachbohrer</b> ➔ M018	<b>MFE-Serie</b> 

Bohrer aus Vollhartmetall ➔ M004

Einlippenbohrer aus Vollhartmetall ➔ M079

Bohrer aus HSS ➔ M005



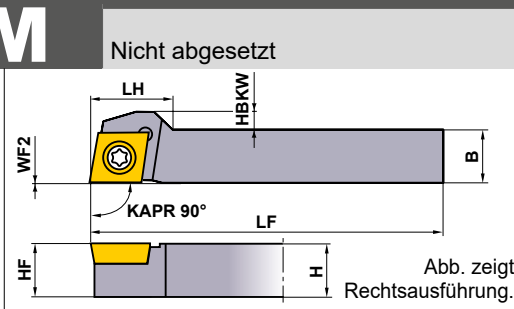
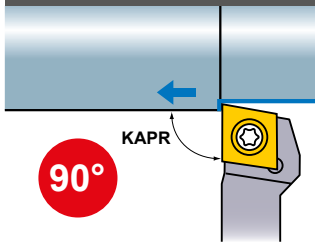

# AUSSEN LÄNGSDREHEN

## SCAC-SM



Schichten SMG/FS (06,09)	Schichten R/L-F (06)	Leicht R/L-SS (06,09)	Leicht LS (06,09)
Mittel	Mittel	Für Nicht-Eisen Metalle	Leicht
R/L-SN (06,09)	R/L-SR (06,09)	AZ (06,09)	LS-P (06,09)



Bestellbezeichnung	Lager		WSP Bezeichnung	Abmessungen (mm)							*  		
	R	L		H	B	LF	LH	HBKW	HF	WF2	Spannschraube	Schlüssel	
SCACR/L0808K06-SM	●	★		0602	8	8	125	11	1.6	8	0	TS254	TKY08R
SCACR/L1010K06-SM	●	★		0602	10	10	125	—	—	10	0	TS254	TKY08R
SCACR/L1010K09-SM	●	★		09T3	10	10	125	16	3.5	10	0	TS43	TKY15R
SCACR/L1212M09-SM	●	★		09T3	12	12	150	14	1.5	12	0	TS43	TKY15R
SCACR/L1616M09-SM	●	★		09T3	16	16	150	—	—	16	0	TS43	TKY15R

\* Spannmoment (N · m) : TS254=1.0, TS43=3.5

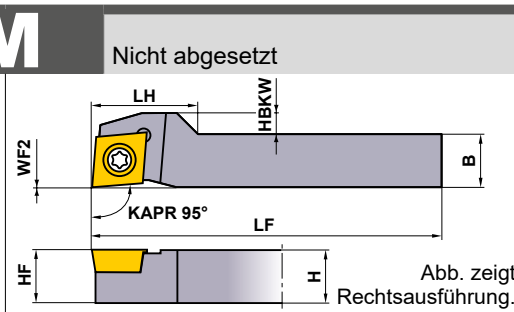
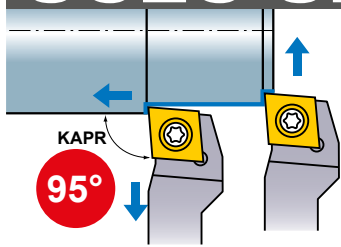
## SCLC-SM



Schichten SMG/FS (06,09)	Schichten R/L-F (06)	Leicht R/L-SS (06,09)	Leicht LS (06,09)
Mittel	Mittel	Für Nicht-Eisen Metalle	Leicht
R/L-SN (06,09)	R/L-SR (06,09)	AZ (06,09)	LS-P (06,09)

Bestellbezeichnung	Lager		WSP Bezeichnung	Abmessungen (mm)							*  		
	R	L		H	B	LF	LH	HBKW	HF	WF2	Spannschraube	Schlüssel	
SCLCR/L0808K06-SM	●	★		0602	8	8	125	11	2.1	8	0	TS254	TKY08R
SCLCR/L1010K06-SM	●	★		0602	10	10	125	—	—	10	0	TS254	TKY08R
SCLCR/L1010K09-SM	●	★		09T3	10	10	125	20	4	10	0	TS43	TKY15R
SCLCR/L1212M09-SM	●	★		09T3	12	12	150	18	2	12	0	TS43	TKY15R
SCLCR/L1616M09-SM	●	★		09T3	16	16	150	—	—	16	0	TS43	TKY15R

\* Spannmoment (N · m) : TS254=1.0, TS43=3.5

Hinweis 1) Die Abbildungen der Wendschneidplatten dienen nur als Beispiel. Die Buchstaben bezeichnen den Spanbrecher, und die Abmessung bezieht sich auf den Innenkreisdurchmesser.

Hinweis 2) Abmessungen für WSP-Schneidenecke RE 0,2 gezeigt.

● : Lagerstandard. ★ : Lagerstandard in Japan.

SCAC-SM WSP	> A139 – A145
SCLC-SM WSP	> A139 – A145
CBN & PKD WSP	> B051, B052, B067

# SDJC-SM

Nicht abgesetzt



Abb. zeigt Rechtsausführung.

Schichten	Schichten	Leicht	Leicht
SMG/FS	R/L-F	R/L-SS	LS
(07, 11)	(07, 11)	(07, 11)	(07, 11)
Mittel	Mittel	Für Nicht-Eisen Metalle	Leicht
R/L-SN	R/L-SR	AZ	LS-P
(07, 11)	(07, 11)	(07, 11)	(07, 11)

Bestellbezeichnung	Lager		WSP Bezeichnung	Abmessungen (mm)							* Spannschraube	Schlüssel	
	R	L		H	B	LF	LH	HBKW	HF	WF2			
SDJCR/L0808K07-SM	●	★	DCMT DCMW DCET DCGT DCGW	0702	8	8	125	15	2	8	0	TS254	TKY08R
SDJCR/L1010K07-SM	●	★		0702	10	10	125	—	—	10	0	TS254	TKY08R
SDJCR/L1010K11-SM	●	★		11T3	10	10	125	24	4	10	0	TS43	TKY15R
SDJCR/L1212M11-SM	●	★		11T3	12	12	150	22	2	12	0	TS43	TKY15R
SDJCR/L1616M11-SM	●	★		11T3	16	16	150	—	—	16	0	TS43	TKY15R

\* Spannmoment (N • m) : TS254=1.0, TS43=3.5

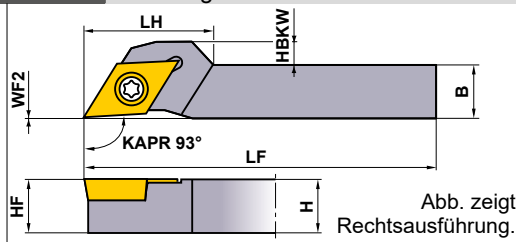
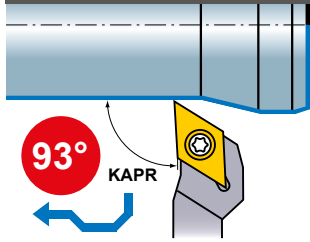
# SDNC-SM

Neutraler WSP-Halter  
Nicht abgesetzt



Abb. zeigt Rechtsausführung.

Schichten	Schichten	Leicht	Leicht
SMG/FS	R/L-F	R/L-SS	LS
(07, 11)	(07, 11)	(07, 11)	(07, 11)
Mittel	Mittel	Für Nicht-Eisen Metalle	Leicht
R/L-SN	R/L-SR	AZ	LS-P
(07, 11)	(07, 11)	(07, 11)	(07, 11)

Bestellbezeichnung	Lager		WSP Bezeichnung	Abmessungen (mm)							* Spannschraube	Schlüssel	
	R	L		H	B	LF	LH	HBKW	HF	WF2			
SDNCR/L0808K07-SM	●	★	DCMT DCMW DCET DCGT DCGW	0702	8	8	125	—	—	8	3	TS254	TKY08R
SDNCR/L1010K07-SM	●	★		0702	10	10	125	—	—	10	3	TS254	TKY08R
SDNCR/L1010K11-SM	●	★		11T3	10	10	125	24	2	10	5	TS43	TKY15R
SDNCR/L1212M11-SM	●	★		11T3	12	12	150	—	—	12	5	TS43	TKY15R
SDNCR/L1616M11-SM	●	★		11T3	16	16	150	—	—	16	5	TS43	TKY15R

\* Spannmoment (N • m) : TS254=1.0, TS43=3.5

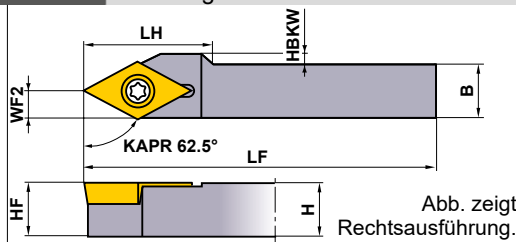
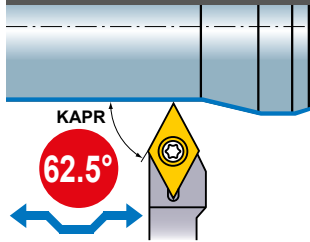
## SCHNITTDATENEMPFEHLUNGEN

	Material	Härte	Sorte	Schnittgeschw. (m/min)	Vorschub (mm/U.)
P	C-Stahl, Leg. Stahl	180HB–280HB	MS6015/VP15TF	100 (50–150)	0.08 (0.01–0.15)
			MS6015	110 (30–180)	0.08 (0.01–0.15)
	Allg. Baustahl	—	NX2525	150 (50–250)	0.08 (0.01–0.15)
M	Rostfreier Stahl	≤200HB	VP15TF/MP9005/MP9015	80 (50–120)	0.06 (0.02–0.1)
		230HB	MS9025	100 (50–180)	0.08 (0.01–0.15)
N	Aluminiumlegierung	—	HTi10/MT9005	150 (70–230)	0.09 (0.03–0.15)
S	Titanlegierung	—	MT9005	60 (40–80)	0.08 (0.04–0.12)
	Hitzebeständiger Stahl	—	MP9015/MS9025	50 (20–75)	0.08 (0.04–0.12)

SDJC-SM WSP > A147–A152  
SDNC-SM WSP > A147–A152  
CBN & PKD WSP > B054, B055, B068

ERSATZTEILE > N001  
TECHNISCHE DATEN > P001



# AUSSEN LÄNGSDREHEN

## SVLP-SM

Nicht abgesetzt



Abb. zeigt Rechtsausführung.

Schichten  
R/L-SRF



Schichten  
SMG

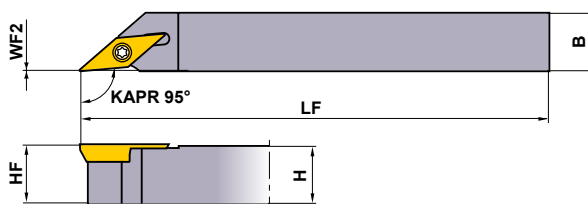
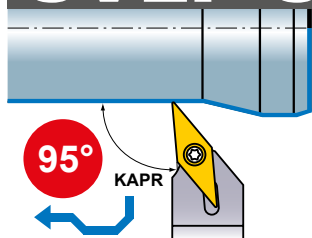

(08,11)

Bestellbezeichnung	Lager		WSP Bezeichnung	Abmessungen (mm)					* Spannschraube	Schlüssel	
	R	L		H	B	LF	HF	WF2			
SVLPR/L1010K08-SM	●	★	VPET VPGT	0802	10	10	125	10	0	TS202	TKY06R
SVLPR/L1212M08-SM	●	★		0802	12	12	150	12	0	TS202	TKY06R
SVLPR/L1010K11-SM	●	★		1103	10	10	125	10	0	TS255	TKY08R
SVLPR/L1212M11-SM	●	★		1103	12	12	150	12	0	TS255	TKY08R
SVLPR/L1616M11-SM	●	★		1103	16	16	150	16	0	TS255	TKY08R

\* Spannmoment (N · m) : TS202=0,6, TS255=1,0

## SVJB-SM

Nicht abgesetzt



Abb. zeigt Rechtsausführung.

Schichten  
R/L-F



Mittel  
R/L-SN

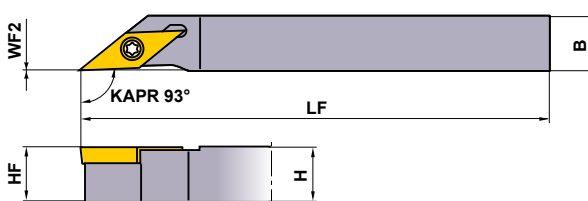
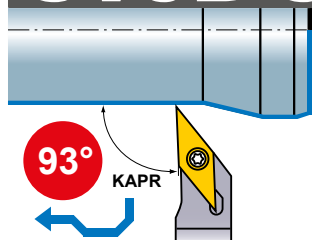
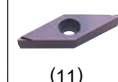

Mittel  
R/L-SR

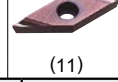

(11)

Bestellbezeichnung	Lager		WSP Bezeichnung	Abmessungen (mm)					* Spannschraube	Schlüssel	
	R	L		H	B	LF	HF	WF2			
SVJBR/L1010K11-SM	●	★	VBMT VBET VBGT VBGW	1103	10	10	125	10	0	TS255	TKY08R
SVJBR/L1212M11-SM	●	★		1103	12	12	150	12	0	TS255	TKY08R
SVJBR/L1616M11-SM	●	★		1103	16	16	150	16	0	TS255	TKY08R

\* Spannmoment (N · m) : TS255=1,0

## SCHNITTDATENEMPFEHLUNGEN

	Material	Härte	Sorte	Schnittgeschw. (m/min)	Vorschub (mm/U.)
P	C-Stahl, Leg. Stahl	180HB–280HB	MS6015/VP15TF	100 (50–150)	0.08 (0.01–0.15)
	Allg. Baustahl	–	MS6015	110 (30–180)	0.08 (0.01–0.15)
			NX2525	150 (50–250)	0.08 (0.01–0.15)
M	Rostfreier Stahl	≤200HB	VP15TF/MP9005/MP9015	80 (50–120)	0.06 (0.02–0.1)
		230HB	MS9025	100 (50–180)	0.08 (0.01–0.15)
N	Aluminiumlegierung	–	HTi10/MT9005	150 (70–230)	0.09 (0.03–0.15)
S	Titanlegierung	–	MT9005	60 (40–80)	0.08 (0.04–0.12)
	Hitzebeständiger Stahl	–	MP9015/MS9025	50 (20–75)	0.08 (0.04–0.12)

Hinweis 1) Die Abbildungen der Wendeschneidplatten dienen nur als Beispiel. Die Buchstaben bezeichnen den Spanbrecher, und die Abmessung bezieht sich auf den Innenkreisdurchmesser.

Hinweis 2) Abmessungen für WSP-Schneidenecke RE 0,2 aufgezzeigt.

● : Lagerstandard. ★ : Lagerstandard in Japan.

SVLP-SM WSP	> A171
SVJB-SM WSP	> A164–A166
CBN & PKD WSP	> B059, B071

# SVJC-SM

Nicht abgesetzt



Abb. zeigt Rechtsausführung.

Schichten	Schichten	Leicht	Leicht
FP	FM	LS	LS-P
(11)	(11)	(11,13)	(11,13)
Leicht	Leicht	Leicht	
LP	LM	LS	
(11)	(11)	(11)	

Bestellbezeichnung	Lager		WSP Bezeichnung	Abmessungen (mm)						*		
	R	L		H	B	LF	HBKW	HF	WF2	Spannschraube	Schlüssel	
SVJCR/L1010JX11-SM	●	●	VCMW VCMT VCGT	1103	10	10	120	—	10	0	TS255	TKY08R
SVJCR/L1212JX11-SM	●	●		1103	12	12	120	—	12	0	TS255	TKY08R
SVJCR/L1616JX11-SM	●	●		1103	16	16	120	—	16	0	TS255	TKY08R
SVJCR/L1010JX13-SM	●	●		1303	10	10	120	2	10	0	TS32	TKY08R
SVJCR/L1212JX13-SM	●	●		1303	12	12	120	—	12	0	TS32	TKY08R
SVJCR/L1616JX13-SM	●	●		1303	16	16	120	—	16	0	TS32	TKY08R

\* Spannmoment (N • m) : TS255=1.0, TS32=1.0

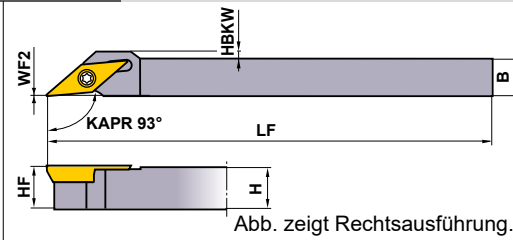
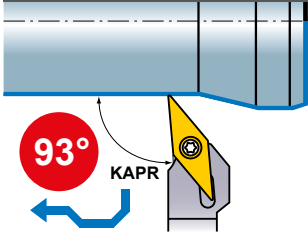
# SVPP-SM



Abb. zeigt Rechtsausführung.

Bestellbezeichnung	Lager		WSP Bezeichnung	Abmessungen (mm)						*			
	R	L		H	B	LF	LH	HBKW	HF	WF2	Spannschraube	Schlüssel	
SVPPR/L1010K11-SM	●	★	VPET VPGT	1103	10	10	125	20	8	10	0	TS255	TKY08R
SVPPR/L1212M11-SM	●	★		1103	12	12	150	20	6	12	0	TS255	TKY08R
SVPPR/L1616M11-SM	●	★		1103	16	16	150	17	—	16	0	TS255	TKY08R

\* Spannmoment (N • m) : TS255=1.0

# SVVB-SM

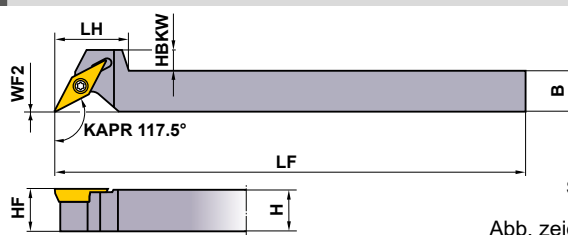
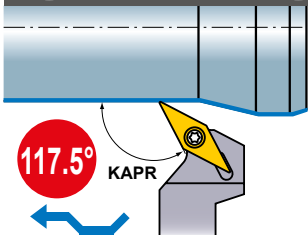
Neutraler WSP Halter



Abb. zeigt Rechtsausführung.

Bestellbezeichnung	Lager		WSP Bezeichnung	Abmessungen (mm)					*		
	R	L		H	B	LF	HF	WF2	Spannschraube	Schlüssel	
SVVBR/L1010K11-SM	●	★	VBET VBGT VBMT VBGW	1103	10	10	125	10	3	TS255	TKY08R
SVVBR/L1212M11-SM	●	★		1103	12	12	150	12	3	TS255	TKY08R
SVVBR/L1616M11-SM	●	★		1103	16	16	150	16	3	TS255	TKY08R

\* Spannmoment (N • m) : TS255=1.0

SVJC-SM WSP > A167–A169  
 SVPP-SM WSP > A171  
 SVVB-SM WSP > A164–A166

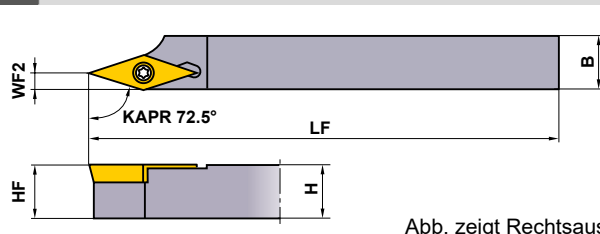
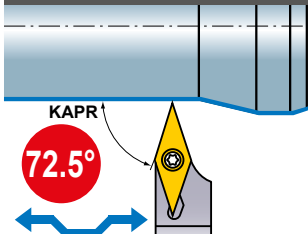
CBN & PKD WSP > B059, B060, B071  
 ERSATZTEILE > N001  
 TECHNISCHE DATEN > P001

D  
SMALL TOOLS

# AUSSEN RÜCKWÄRTSDREHEN

## BTAH



Abb. zeigt Rechtsausführung.

Bestellbezeichnung	Lager		WSP Bezeichnung	Abmessungen (mm)										* Spannschraube	Schlüssel			
	R	L		H	B	LF	LH	HF	WF2	HBH	HBL	CDX						
BTahr/L0810-50	●	★	BTAT	5528	○	○	R/L-B	8	10	120	15	8	3.5	4	9.5	5.5	NS402W	NKY15S
BTahr/L1010-50	●	★		6035	○	○	R/L-B	10	10	120	15	10	3.5	2	9.5	5.5	NS402W	NKY15S
BTahr/L1212-50	●	★		605000RX				12	12	120	15	12	3.5	—	9.5	5.5	NS403W	NKY15S
BTahr/L1616-50	●			7235	○	○	R-SMB	16	16	120	15	16	3.5	—	9.5	5.5	NS403W	NKY15S

Hinweis 1) Bitte verwenden Sie rechte WSP für rechte Halter und linke WSP für linke Halter.

Hinweis 2) Maximale Schnitttiefe auf weniger als 60 % der effektiven Schneidkantenlänge (LE) einstellen.

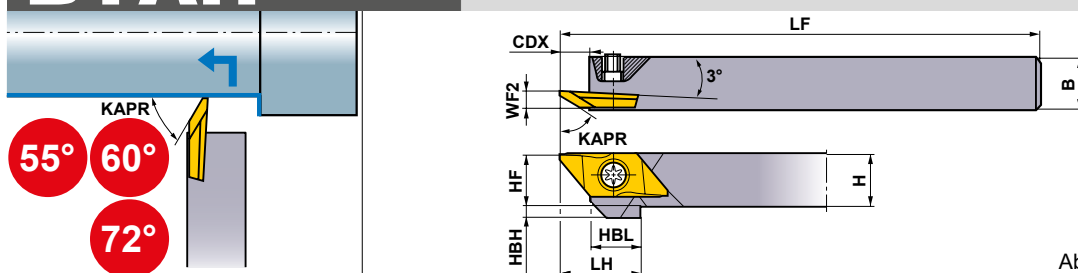
\* Spannmoment (N • m) : NS402W=1.0, NS403W=1.0

### WSP

Bestellbezeichnung	Richtung	Beschichtet		Abmessungen (mm)							* LE (mm)	Abbildung	
		VP15TF	NEW MS6015	PSIRR/L*	RER/L	CF	L	W1	CW	S			
NEW BTAT7235V5R-SMB	R	●		72°	0.05	0.3	20	8	1.4	2.5	3.5	Mit Spanbrecher	
NEW BTAT723501MR-SMB	R	●		72°	0.08	0.3	20	8	1.4	2.5	3.5		
NEW BTAT723502MR-SMB	R	●		72°	0.18	0.3	20	8	1.4	2.5	3.5		
BTAT552800R-B	R	●	●	55°	0	0	20	8	0.5	2.5	2.8		
BTAT552800L-B	L	★		55°	0	0	20	8	0.5	2.5	2.8	<p>Typ SMB (gesintert)</p> <p>Typ B (geschliffen)</p> <p>Abb. zeigt rechte WSP.</p>	
BTAT552801R-B	R	●	●	55°	0.1	0	20	8	0.5	2.5	2.8		
BTAT552801L-B	L	★		55°	0.1	0	20	8	0.5	2.5	2.8		
BTAT603500R-B	R	●	●	60°	0	0	20	8	0.5	2.5	3.5		
BTAT603500L-B	L	★		60°	0	0	20	8	0.5	2.5	3.5		
NEW BTAT603501MR-B	R	●	●	60°	0.08	0	20	8	0.5	2.5	3.5		
BTAT603501R-B	R	●	●	60°	0.1	0	20	8	0.5	2.5	3.5		
BTAT603501L-B	L	★		60°	0.1	0	20	8	0.5	2.5	3.5		
BTAT605000RX	R	●		60°	0	0	20	8	1.25	2.5	5.0		Ohne Spanbrecher

Hinweis 1) Abmessungen REL und PSIRR für rechten Werkzeughalter sowie RER und PSIRL für linken Werkzeughalter.

\* Angegebener Winkel bei Montage auf Halter.

● = NEW

### SCHNITTDATENEMPFEHLUNGEN

	Material	Härte	Sorte	Schnittgeschw. (m/min)	Vorschub (mm/U.)
P	C-Stahl, Leg. Stahl	180HB–280HB	MS6015/VP15TF	100 (50–150)	0.08 (0.01–0.15)
	Allg. Baustahl	—	MS6015	110 (30–180)	0.08 (0.01–0.15)
M	Rostfreier Stahl	≤200HB	VP15TF	80 (50–120)	0.06 (0.02–0.1)
N	Aluminiumlegierung	—	MS6015	150 (70–230)	0.09 (0.03–0.15)

● : Lagerstandard. ★ : Lagerstandard in Japan.

(5 WSP je VPE)

# CTBH





Abb. zeigt Rechtsausführung.

Bestellbezeichnung	Lager		WSP Bezeichnung	Abmessungen (mm)								*  					
	R	L		H	B	LF	LH	HF	WF2	HBH	HBL	CDX	Spannschraube	Schlüssel			
CTBHR/L1010-160	●	●	BTBT	60450	○	R/L-B	10	10	120	19.5	10	3.4	2	12	7.5	NS402W	NKY15S
CTBHR/L1212-160	●	●		606000	R/L	12	12	120	19.5	12	3.4	—	12	7.5	NS403W	NKY15S	
CTBHR/L1616-160	●	●		7055	○	R-SMB	16	16	120	19.5	16	3.4	—	12	7.5	NS403W	NKY15S

Hinweis 1) Bitte verwenden Sie rechte WSP für rechte Halter und linke WSP für linke Halter.

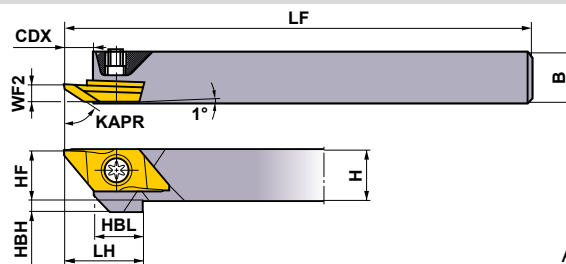
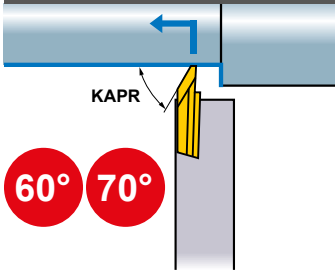
Hinweis 2) Maximale Schnitttiefe auf weniger als 60 % der effektiven Schneidkantenlänge (LE) einstellen.

\* Spannmoment (N · m) : NS402W=1.0, NS403W=1.0

## WSP

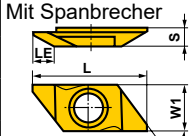
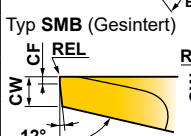
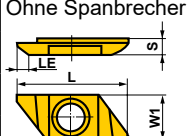
Bestellbezeichnung	Richtung	Beschichtet		Abmessungen (mm)								LE* (mm)	Abbildung
		VP15TF	NEW MS6015	PSIRR/L*	RER/L	CF	L	W1	CW	S	CDX		
NEW BTBT7055V5R-SMB	R	●		70°	0.05	0.3	25	9.4	1.35	3.5	6.5	5.5	Mit Spanbrecher 
NEW BTBT705501MR-SMB	R	●		70°	0.08	0.3	25	9.4	1.35	3.5	6.5	5.5	
NEW BTBT705502MR-SMB	R	●		70°	0.18	0.3	25	9.4	1.35	3.5	6.5	5.5	
BTBT604500R-B	R	●	●	60°	0	0.2	25	9.4	0.7	3.5	5.5	4.5	Typ SMB (Gesintert) Typ B (geschliffen)  Abb. zeigt rechte WSP.
BTBT604500L-B	L	★		60°	0	0.2	25	9.4	0.7	3.5	5.5	4.5	
NEW BTBT604501MR-B	R		●	60°	0.08	0.3	25	9.4	0.7	3.5	5.5	4.5	
BTBT604501R-B	R	●	●	60°	0.1	0.3	25	9.4	0.7	3.5	5.5	4.5	
BTBT604501L-B	L	★		60°	0.1	0.3	25	9.4	0.7	3.5	5.5	4.5	
BTBT606000R	R	●		60°	0	0.2	25	9.4	0.7	3.5	7	6.0	
BTBT606000L	L	★		60°	0	0.2	25	9.4	0.7	3.5	7	6.0	Ohne Spanbrecher  Abb. zeigt rechte WSP.

Hinweis 1) Abmessungen REL und PSIRR für rechten Werkzeughalter sowie RER und PSIRL für linken Werkzeughalter.

\* Angegebener Winkel bei Montage auf Halter.

● = NEW

# AUSSEN RÜCKWÄRTSDREHEN

## BTVH

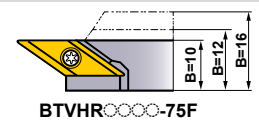
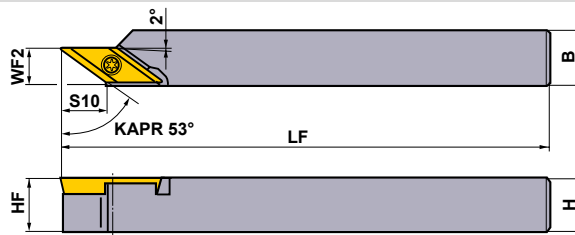
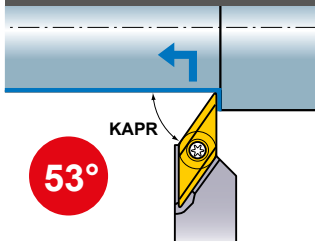

Nur Rechtsausführung  
lieferbar.

Bestellbezeichnung	Lager	WSP Bezeichnung	Abmessungen (mm)						*	
	R		H	B	LF	HF	WF2	S10	Spannschraube	Schlüssel
<b>BTVHR1010-75</b>	●	BTVT 5375○○R-B	10	10	120	10	7.5	8.5	NS251	NKY15S
<b>BTVHR1212-75</b>	●		12	12	120	12	7.5	8.5	NS251	NKY15S
<b>BTVHR1616-75</b>	●		16	16	120	16	7.5	8.5	NS251	NKY15S
<b>BTVHR1010-75F</b>	●		10	10	120	10	10.0	8.5	NS251	NKY15S
<b>BTVHR1212-75F</b>	●		12	12	120	12	10.0	8.5	NS251	NKY15S
<b>BTVHR1616-75F</b>	●		16	16	120	16	10.0	8.5	NS251	NKY15S

Hinweis 1) Maximale Schnitttiefe auf weniger als 30 % der effektiven Schneidkantenlänge (LE) einstellen.

Hinweis 2) Für die Bearbeitung unter hoher Belastung wird der F-Typ empfohlen.

\* Spannmoment (N • m) : NS251=1.0

SMALL TOOLS

D

## WSP

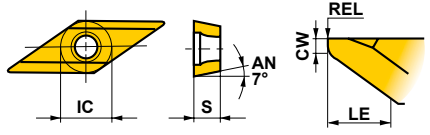
Bestellbezeichnung	Richtung	Beschichtet	Abmessungen (mm)				LE* (mm)	Abbildung
		VP15TF	IC	S	REL	CW		
<b>BTVT5375V5R-B</b>	R	●	6.35	3.18	0.05	0.5	7.5	Mit Spanbrecher 
<b>BTVT537501R-B</b>	R	●	6.35	3.18	0.1	0.5	7.5	

\* Angegebener Winkel bei Montage auf Halter.

## SCHNITTDATENEMPFEHLUNGEN

	Material	Härte	Sorte	Schnittgeschw. (m/min)	Vorschub (mm/U.)
<b>P</b>	C-Stahl, Leg. Stahl	180HB–280HB	<b>VP15TF</b>	100 (50–150)	0.08 (0.01–0.15)
	Allg. Baustahl	–	<b>VP15TF</b>	110 (30–180)	0.08 (0.01–0.15)
<b>M</b>	Rostfreier Stahl	≤200HB	<b>VP15TF</b>	80 (50–120)	0.06 (0.02–0.1)
<b>N</b>	Aluminiumlegierung	–	<b>VP15TF</b>	150 (70–230)	0.09 (0.03–0.15)

● : Lagerstandard.  
(5 WSP je VPE)

ERSATZTEILE > N001  
TECHNISCHE DATEN > P001



# AUSSEN EINSTECHEN

## GTAH, GTBH, GTCH



Abb. zeigt Rechtsausführung.

Bestellbezeichnung	Lager		WSP Bezeichnung	Abmessungen (mm)									Schnittbreite (mm)	*2		
	R	L		H	B	HF	LF	CDX*1	LH	HBH	HBL	Spannschraube		Schlüssel		
<b>Standard Schaft</b>																
GTAHR/L0808-20S	●	★	GTAT	○○○○	8	8	8	80	2	15	5	12.9	0.3-3.0	NS404W	NKY15S	
GTAHR/L1010-20S	●	★	GTBT *1	○○○○	10	10	10	80	2	15	3	12.9	0.3-3.0	NS404W	NKY15S	
GTAHR/L1212-20S	●	★	GTCT *1	○○○○	12	12	12	80	2	15	1	12.9	0.3-3.0	NS404W	NKY15S	
GTBHR/L1010-30S	●	★	GTBT. GTCT	○○○○	10	10	10	80	3	15	3	13.4	1.45-3.0	NS404W	NKY15S	
GTCHR/L1010-30S	★	★	GTCT	○○○○	10	10	10	80	3	15	3	13.4	2.5-3.0	NS404W	NKY15S	
<b>Langer Schaft</b>																
GTAHR/L0808-20	●	★	GTAT	○○○○	8	8	8	120	2	15	5	12.9	0.3-3.0	NS404W	NKY15S	
GTAHR/L1010-20	●	★	GTBT *1	○○○○	10	10	10	120	2	15	3	12.9	0.3-3.0	NS404W	NKY15S	
GTAHR/L1212-20	●	★	GTCT *1	○○○○	12	12	12	120	2	15	1	12.9	0.3-3.0	NS404W	NKY15S	
GTAHR/L1616-20	●	★	GTCT	○○○○	16	16	16	120	2	15	-	12.9	0.3-3.0	NS404W	NKY15S	
GTBHR/L1010-30	●	★	GTBT. GTCT	○○○○	10	10	10	120	3	15	3	13.4	1.45-3.0	NS404W	NKY15S	
GTBHR/L1212-30	●	★	GTBT. GTCT	○○○○	12	12	12	120	3	15	1	13.4	1.45-3.0	NS404W	NKY15S	
GTBHR/L1616-30	●	★	GTCT	○○○○	16	16	16	120	3	15	-	13.4	1.45-3.0	NS404W	NKY15S	
GTCHR/L1010-30	★	★	GTCT	○○○○	10	10	10	120	3	15	3	13.4	2.5-3.0	NS404W	NKY15S	

Hinweis 1) Bitte verwenden Sie rechte WSP für rechte Halter und linke WSP für linke Halter.

\*1 Stechtiefen größer als CDX Abmessungen (max. Stechtiefe) sind nicht möglich.

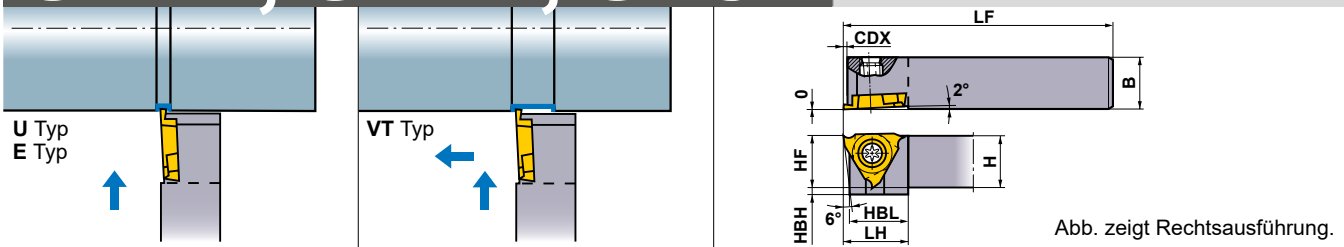
\*2 Spannmoment (N · m) : NS404W=1.0

### WSP

Bestellbezeichnung	Richtung	Beschichtet	Abmessungen (mm)					Abbildung
			VP15TF	CW	CDX*1	RER/L	IC	
GTAH03006V3R-U	R	●	0.3	0.6	0.03	9.525	3.18	
GTAH03006V3L-U	L	★	0.3	0.6	0.03	9.525	3.18	
GTAH05012V5R-U	R	●	0.5	1.2	0.05	9.525	3.18	
GTAH05012V5L-U	L	★	0.5	1.2	0.05	9.525	3.18	
GTAH07520V5R-U	R	●	0.75	2.0	0.05	9.525	3.18	
GTAH07520V5L-U	L	★	0.75	2.0	0.05	9.525	3.18	
GTAH09520V5R-U	R	●	0.95	2.0	0.05	9.525	3.18	
GTAH09520V5L-U	L	★	0.95	2.0	0.05	9.525	3.18	
GTAH10020V5R-U	R	●	1.0	2.0	0.05	9.525	3.18	
GTAH10020V5L-U	L	★	1.0	2.0	0.05	9.525	3.18	
GTAH10320V5R-U	R	●	1.03	2.0	0.05	9.525	3.18	
GTAH12520V5R-U	R	●	1.25	2.0	0.05	9.525	3.18	
GTAH12520V5L-U	L	★	1.25	2.0	0.05	9.525	3.18	
GTBT14530V5R-U	R	●	1.45	3.0	0.05	9.525	3.18	
GTBT14530V5L-U	L	★	1.45	3.0	0.05	9.525	3.18	
GTBT15030V5R-U	R	●	1.5	3.0	0.05	9.525	3.18	
GTBT15030V5L-U	L	★	1.5	3.0	0.05	9.525	3.18	
GTBT17530V5R-U	R	●	1.75	3.0	0.05	9.525	3.18	
GTBT17530V5L-U	L	★	1.75	3.0	0.05	9.525	3.18	
GTBT20030V5R-U	R	●	2.0	3.0	0.05	9.525	3.18	
GTBT20030V5L-U	L	★	2.0	3.0	0.05	9.525	3.18	
GTCT25030V5R-U	R	★	2.5	3.0	0.05	9.525	3.18	
GTCT25030V5L-U	L	★	2.5	3.0	0.05	9.525	3.18	

Abb. zeigt rechte WSP.

\*Stechtiefen größer als CDX Abmessungen (max Stechtiefe) sind nicht möglich.

● : Lagerstandard. ★ : Lagerstandard in Japan.  
(5 WSP je VPE)

# WSP

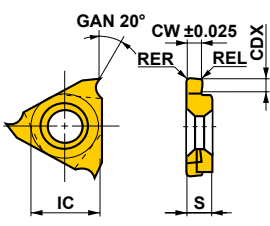
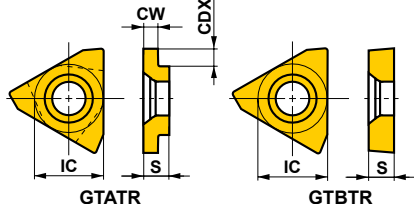
Bestellbezeichnung	Richtung	Beschichtet	Hartmetall	Abmessungen (mm)					Abbildung
		VP15TF	TF15	CW	CDX	RER/L	IC	S	
GTAT03306V3R-E	R	●		0.33	0.6	0.03	9.525	3.18	 <p>Abb. zeigt rechte WSP.</p>
GTAT03306V3L-E	L	★		0.33	0.6	0.03	9.525	3.18	
GTAT04312V3R-E	R	●		0.43	1.2	0.03	9.525	3.18	
GTAT04312V3L-E	L	★		0.43	1.2	0.03	9.525	3.18	
GTAT05312V5R-E	R	●		0.53	1.2	0.05	9.525	3.18	
GTAT05312V5L-E	L	★		0.53	1.2	0.05	9.525	3.18	
GTAT07520V5R-E	R	●		0.75	2.0	0.05	9.525	3.18	
GTAT07520V5L-E	L	★		0.75	2.0	0.05	9.525	3.18	
GTAT09520V5R-E	R	●		0.95	2.0	0.05	9.525	3.18	
GTAT09520V5L-E	L	★		0.95	2.0	0.05	9.525	3.18	
GTAT10020V5R-E	R	●		1.0	2.0	0.05	9.525	3.18	
GTAT10020V5L-E	L	★		1.0	2.0	0.05	9.525	3.18	
GTAT1002001R-E	R	●		1.0	2.0	0.1	9.525	3.18	
GTAT1002001L-E	L	★		1.0	2.0	0.1	9.525	3.18	
GTAT12020V5R-E	R	●		1.2	2.0	0.05	9.525	3.18	
GTAT12020V5L-E	L	★		1.2	2.0	0.05	9.525	3.18	
GTAT1202001R-E	R	●		1.2	2.0	0.1	9.525	3.18	
GTAT1202001L-E	L	★		1.2	2.0	0.1	9.525	3.18	
GTAT14020V5R-E	R	●		1.4	2.0	0.05	9.525	3.18	
GTAT14020V5L-E	L	★		1.4	2.0	0.05	9.525	3.18	
GTBT15030V5R-E	R	●		1.5	3.0	0.05	9.525	3.18	
GTBT15030V5L-E	L	★		1.5	3.0	0.05	9.525	3.18	
GTBT1503001R-E	R	●		1.5	3.0	0.1	9.525	3.18	
GTBT1503001L-E	L	★		1.5	3.0	0.1	9.525	3.18	
GTBT18030V5R-E	R	●		1.8	3.0	0.05	9.525	3.18	
GTBT18030V5L-E	L	★		1.8	3.0	0.05	9.525	3.18	
GTBT20030V5R-E	R	●		2.0	3.0	0.05	9.525	3.18	
GTBT20030V5L-E	L	★		2.0	3.0	0.05	9.525	3.18	
GTBT2003001R-E	R	●		2.0	3.0	0.1	9.525	3.18	
GTBT2003001L-E	L	★		2.0	3.0	0.1	9.525	3.18	
GTBT22530V5R-E	R	●		2.25	3.0	0.05	9.525	3.18	
GTBT22530V5L-E	L	★		2.25	3.0	0.05	9.525	3.18	
GTCT25030V5R-E	R	★		2.5	3.0	0.05	9.525	3.18	
GTCT25030V5L-E	L	★		2.5	3.0	0.05	9.525	3.18	
GTCT27530V5R-E	R	★		2.75	3.0	0.05	9.525	3.18	
GTCT27530V5L-E	L	★		2.75	3.0	0.05	9.525	3.18	
GTCT30030V5R-E	R	★		3.0	3.0	0.05	9.525	3.18	
GTCT30030V5L-E	L	★		3.0	3.0	0.05	9.525	3.18	
GTATR	R		★★	1.76	3.0	—	9.525	3.18	<p>Glatt</p>  <p>Abb. zeigt rechte WSP.</p>
GTATL	L		★★	1.76	3.0	—	9.525	3.18	
GTBTR	R		★★	—	0	—	9.525	3.18	
GTBTL	L		★★	—	0	—	9.525	3.18	

\* 10 Stck.

D  
SMALL TOOLS



# AUSSEN ABSTECHEN

## CTAH



Abb. zeigt Rechtsausführung.

Bestellbezeichnung	Lager		WSP Bezeichnung	Abmessungen (mm)									CUTDIA (mm)	*2		
	R	L		H	B	HF	LF	LH	CDX	HBH	HBL	S10		Spannschraube	Schlüssel	
CTAHR/L0810-120	●	●	CTAT	○ ○ ○ ○	8	10	8	120	15	5.5	4	9.5	22	12 (8)*1	NS402W	NKY15S
CTAHR/L1010-120	●	●		○ ○ ○ ○	10	10	10	120	15	5.5	2	9.5	22		NS402W	NKY15S
CTAHR/L1212-120	●	●		○ ○ ○ ○	12	12	12	120	15	5.5	—	9.5	22		NS403W	NKY15S
CTAHR/L1616-120	●	●		○ ○ ○ ○	16	16	16	120	15	5.5	—	9.5	22		NS403W	NKY15S

\*1 Bei einer Abstechbreite von (CW) 0,7 mm.

\*2 Spannmoment (N • m) : NS402W=1.0, NS403W=1.0

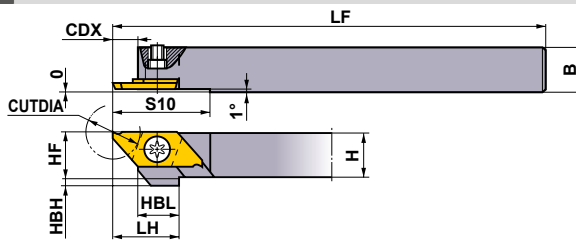
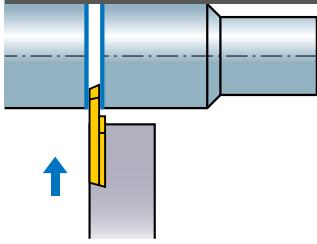
SMALL TOOLS

## CTAH-S



Abb. zeigt Rechtsausführung.

Bestellbezeichnung	Lager	WSP Bezeichnung	Abmessungen (mm)										CUTDIA (mm)	*2		
			H	B	HF	LF	LH	CDX	HBH	HBL	S10	S11		Spannschraube	Schlüssel	
CTAHR1010-120S	●	CTAT	○ ○ ○ ○	10	10	10	80	15	16	2	9.5	16	5.5	12 (8)*1	NS401	NKY25R

\*1 Bei einer Abstechbreite von (CW) 0,7 mm.

\*2 Spannmoment (N • m) : NS401=3.5

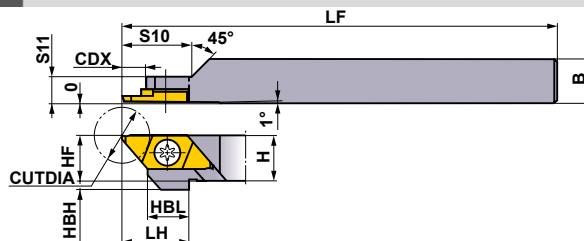
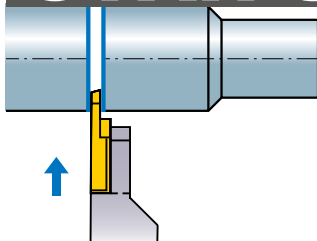
## SCHNITTDATENEMPFEHLUNGEN

	Material	Härte	Sorte	Schnittgeschw. (m/min)	Vorschub (mm/U.)
P	C-Stahl, Leg. Stahl	180HB–280HB	MS6015/VP15TF	100 (50–150)	0.05 (0.02–0.09)
	Allg. Baustahl	—	MS6015	110 (30–180)	0.05 (0.01–0.09)
M	Rostfreier Stahl	≤200HB	VP15TF	80 (50–120)	0.03 (0.02–0.05)
N	Aluminiumlegierung	—	MS6015	150 (70–230)	0.07 (0.03–0.11)

● : Lagerstandard.  
(5 WSP je VPE)

# WSP

Halter	Ausführung	Spanbrecher	Abbildung	Geometrie	Bestellbezeichnung	Richtung	Beschichtet		Abmessungen (mm)								CUTDIA (mm)			
							VP15TF	MS6015	CW	CDX	RER/L	L	W1	S	LBB					
Rechtsausführung	16°	Mit Spanbrecher			CTAT07080V5RR-B	R	●		0.7	4.5	0.05	20	8	2.5	1.5	8				
					CTAT10120V5RR-B	R	●	●	1.0	6.7	0.05	20	8	2.5	1.5	12				
					CTAT15120V5RR-B	R	●	●	1.5	6.7	0.05	20	8	2.5	1.5	12				
					CTAT20120V5RR-B	R	●	●	2.0	6.7	0.05	20	8	2.5	1.5	12				
	16°	Mit Spanbrecher			CTAT15120V5RR-BX	R	●		1.5	6.7	0.05	20	8	2.5	1.5	12				
					CTAT20120V5RR-BX	R	●		2.0	6.7	0.05	20	8	2.5	1.5	12				
					0°	Mit Spanbrecher			CTAT10120V5RN-B	N	●	●	1.0	6.7	0.05	20	8	2.5	1.5	12
									CTAT15120V5RN-B	N	●	●	1.5	6.7	0.05	20	8	2.5	1.5	12
	0°	Mit Spanbrecher			CTAT20120V5RN-B	N	●	●	2.0	6.7	0.05	20	8	2.5	1.5	12				
					CTAT15120V5RN-BX	N	●		1.5	6.7	0.05	20	8	2.5	1.5	12				
					CTAT20120V5RN-BX	N	●		2.0	6.7	0.05	20	8	2.5	1.5	12				
					16°	Ohne Spanbrecher			CTAT10110V5RL-B	L	●		1.0	6.7	0.05	20	8	2.5	1.5	11
CTAT15110V5RL-B	L	●		1.5					6.7	0.05	20	8	2.5	1.5	11					
CTAT20110V5RL-B	L	●		2.0					6.7	0.05	20	8	2.5	1.5	11					
Linksausführung	20°	Ohne Spanbrecher			CTAT1012000RR	R	●	●	1.0	6.7	0	20	8	2.5	3.5	12				
					CTAT1512000RR	R	●	●	1.5	6.7	0	20	8	2.5	3.5	12				
					CTAT2012000RR	R	●	●	2.0	6.7	0	20	8	2.5	3.5	12				
	16°	Mit Spanbrecher			CTAT07080V5LL-B	L	●		0.7	4.5	0.05	20	8	2.5	1.5	8				
					CTAT10120V5LL-B	L	●		1.0	6.7	0	20	8	2.5	1.5	12				
					CTAT15120V5LL-B	L	●		1.5	6.7	0	20	8	2.5	1.5	12				
					CTAT20120V5LL-B	L	●		2.0	6.7	0	20	8	2.5	1.5	12				
	0°	Mit Spanbrecher			CTAT10120V5LN-B	N	●	●	1.0	6.7	0.05	20	8	2.5	1.5	12				
					CTAT15120V5LN-B	N	●	●	1.5	6.7	0.05	20	8	2.5	1.5	12				
					CTAT20120V5LN-B	N	●	●	2.0	6.7	0.05	20	8	2.5	1.5	12				
	16°	Ohne Spanbrecher			CTAT10110V5LR-B	R	●	●	1.0	6.7	0.05	20	8	2.5	1.5	11				
					CTAT15110V5LR-B	R	●	●	1.5	6.7	0.05	20	8	2.5	1.5	11				
CTAT20110V5LR-B					R	●	●	2.0	6.7	0.05	20	8	2.5	1.5	11					
20°	Ohne Spanbrecher			CTAT1012000LL	L	●		1.0	6.7	0	20	8	2.5	3.5	12					
				CTAT1512000LL	L	●		1.5	6.7	0	20	8	2.5	3.5	12					
				CTAT2012000LL	L	●		2.0	6.7	0	20	8	2.5	3.5	12					



Abb. zeigt rechte WSP.

D

SMALL TOOLS

# AUSSEN ABSTECHEN

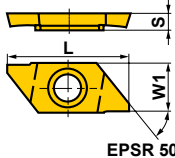
## CTBH



Abb. zeigt Rechtsausführung.

Bestellbezeichnung	Lager		WSP Bezeichnung	Abmessungen (mm)										CUTDIA (mm)	*	
	R	L		H	B	HF	LF	LH	CDX	HBH	HBL	S10	Spannschraube		Schlüssel	
CTBHR/L1010-160	●	●	CTBT	10	10	10	120	19.5	7.5	2	9.5	25	16	NS402W	NKY15S	
CTBHR/L1212-160	●	●		12	12	12	120	19.5	7.5	—	9.5	25	16	NS403W	NKY15S	
CTBHR/L1616-160	●	●		16	16	16	120	19.5	7.5	—	9.5	25	16	NS403W	NKY15S	

\* Spannmoment (N • m) : NS402W=1.0, NS403W=1.0

SMALL TOOLS

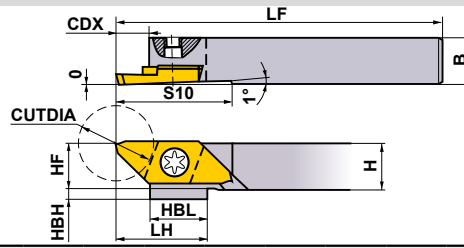
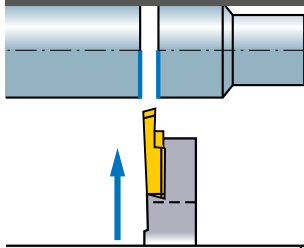
### WSP

Halter	Ausführung	Spantbrecher	Abbildung	Geometrie	Bestellbezeichnung	Richtung	Beschichtet		Abmessungen (mm)							CUTDIA (mm)
							VP15TF	MS6015	CW	CDX	RER/L	L	W1	S		
Rechtsausführung	16°	Mit Spantbrecher			CTBT15160V5RR-B	R	●	●	1.5	9.2	0.05	25	9.4	3.5	16	
					CTBT20160V5RR-B	R	●	●	2.0	9.2	0.05	25	9.4	3.5	16	
	0°				CTBT20160V5RN-B	N	●	●	2.0	9.2	0.05	25	9.4	3.5	16	
Linksausführung	16°	Mit Spantbrecher			CTBT20160V5LL-B	L	●		2.0	9.2	0.05	25	9.4	3.5	16	
	0°				CTBT20160V5LN-B	N	●	●	2.0	9.2	0.05	25	9.4	3.5	16	
	16°				CTBT20145V5LR-B	R	●	●	2.0	9.2	0.05	25	9.4	3.5	14.5	

Abb. zeigt rechte WSP.

### SCHNITTDATENEMPFEHLUNGEN

	Material	Härte	Sorte	Schnittgeschw. (m/min)	Vorschub (mm/U.)
P	C-Stahl, Leg. Stahl	180HB–280HB	MS6015/VP15TF	100 (50–150)	0.05 (0.02–0.09)
	Allg. Baustahl	—	MS6015	110 (30–180)	0.05 (0.01–0.09)
M	Rostfreier Stahl	≤200HB	VP15TF	80 (50–120)	0.03 (0.02–0.05)
N	Aluminiumlegierung	—	MS6015	150 (70–230)	0.07 (0.03–0.11)

● : Lagerstandard.  
(5 WSP je VPE)

ERSATZTEILE > N001  
TECHNISCHE DATEN > P001

# Notizen

---

A series of horizontal dashed lines for writing notes, spanning the width of the page.

# AUSSENGEWINDE DREHEN

## TTAH











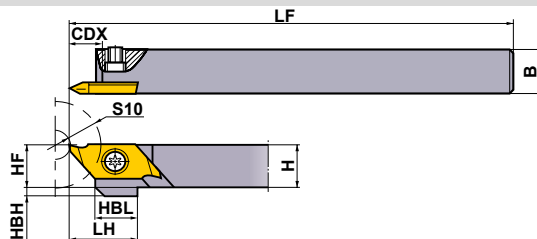
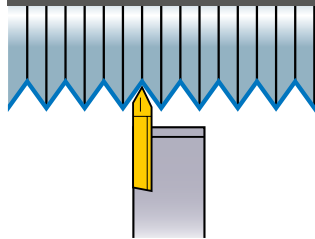





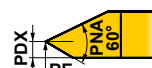

Abb. zeigt Rechtsausführung.

Bestellbezeichnung	Lager		WSP Bezeichnung	Abmessungen (mm)										*  	
	R	L		H	B	HF	LF	LH	HBH	HBL	CDX	S10	Spannschraube	Schlüssel	
TTAHR/L0810	●	★	TTAT		8	10	8	120	15	4	9.5	7	6.5	NS402W	NKY15S
TTAHR/L1010	●	★			10	10	10	120	15	2	9.5	7	6.5	NS402W	NKY15S
TTAHR/L1212	●	★			12	12	12	120	15	—	9.5	7	6.5	NS403W	NKY15S
TTAHR/L1616	●	★			16	16	16	120	15	—	9.5	7	6.5	NS403W	NKY15S

\* Spannmoment (N • m) : NS402W=1.0, NS403W=1.0

SMALL TOOLS

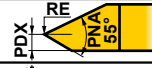
## WSP

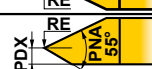
Halter	Ausführung	Spanbrecher	Abbildung	Geometrie	Bestellbezeichnung	Richtung	Beschichtet	Abmessungen (mm)					Steigung mm (Gang/Zoll)
							VP15TF	PDX	RE	L	W1	S	
Rechtsausführung		Mit Spanbrecher	Allg. Bearbeitung Teilprofil (60°)		TTAT60075F5RR-B	R	●	0.4	0.05 Glatt	20.0	8.0	2.5	0.2–0.75 (80–36)
					TTAT60125V5RR-B	R	●	0.8	0.05	20.0	8.0	2.5	0.5–1.25 (40–16)
					TTAT60075F5RL-B	L	●	0.4	0.05 Glatt	20.0	8.0	2.5	0.2–0.75 (80–36)
					TTAT60125V5RL-B	L	●	0.8	0.05	20.0	8.0	2.5	0.5–1.25 (40–16)
Linksausführung		Mit Spanbrecher	Allg. Bearbeitung Teilprofil (60°)		TTAT6015001RN-B	N	●	1.25	0.1	20.0	8.0	2.5	1.0–1.5 (24–18)
					TTAT60075F5LR-B	R	●	0.4	0.05 Glatt	20.0	8.0	2.5	0.2–0.75 (80–36)
					TTAT60125V5LR-B	R	●	0.8	0.05	20.0	8.0	2.5	0.5–1.25 (40–16)
					TTAT60075F5LL-B	L	●	0.4	0.05 Glatt	20.0	8.0	2.5	0.2–0.75 (80–36)
Linksausführung		Mit Spanbrecher	Allg. Bearbeitung Teilprofil (60°)		TTAT60125V5LL-B	L	●	0.8	0.05	20.0	8.0	2.5	0.5–1.25 (40–16)
					TTAT6015001LN-B	N	●	1.25	0.1	20.0	8.0	2.5	1.0–1.5 (24–18)
					TTAT55158V5RR-B	R	●	0.8	0.05	20.0	8.0	2.5	(40–16)
					TTAT55158V5RL-B	L	●	0.8	0.05	20.0	8.0	2.5	(40–16)
Rechtsausführung		Mit Spanbrecher	Allg. Bearbeitung Teilprofil (55°)		TTAT55158V5LR-B	R	●	0.8	0.05	20.0	8.0	2.5	(40–16)
					TTAT55158V5LL-B	L	●	0.8	0.05	20.0	8.0	2.5	(40–16)
Linksausführung		Mit Spanbrecher	Allg. Bearbeitung Teilprofil (55°)		TTAT55158V5LR-B	R	●	0.8	0.05	20.0	8.0	2.5	(40–16)
					TTAT55158V5LL-B	L	●	0.8	0.05	20.0	8.0	2.5	(40–16)

## SCHNITTDATENEMPFEHLUNGEN

Material	Härte	Schnittgeschw. (m/min)	Material	Härte	Schnittgeschw. (m/min)
<b>P</b> C-Stahl, Leg. Stahl	180HB–280HB	100 (50–150)	<b>M</b> Rostfreier Stahl	≤200HB	80 (50–120)
Allg. Baustahl	—	110 (30–180)	<b>N</b> Aluminiumlegierung	—	150 (70–230)

● : Lagerstandard. ★ : Lagerstandard in Japan.  
(5 WSP je VPE)

## ANWENDUNG DER HALTER

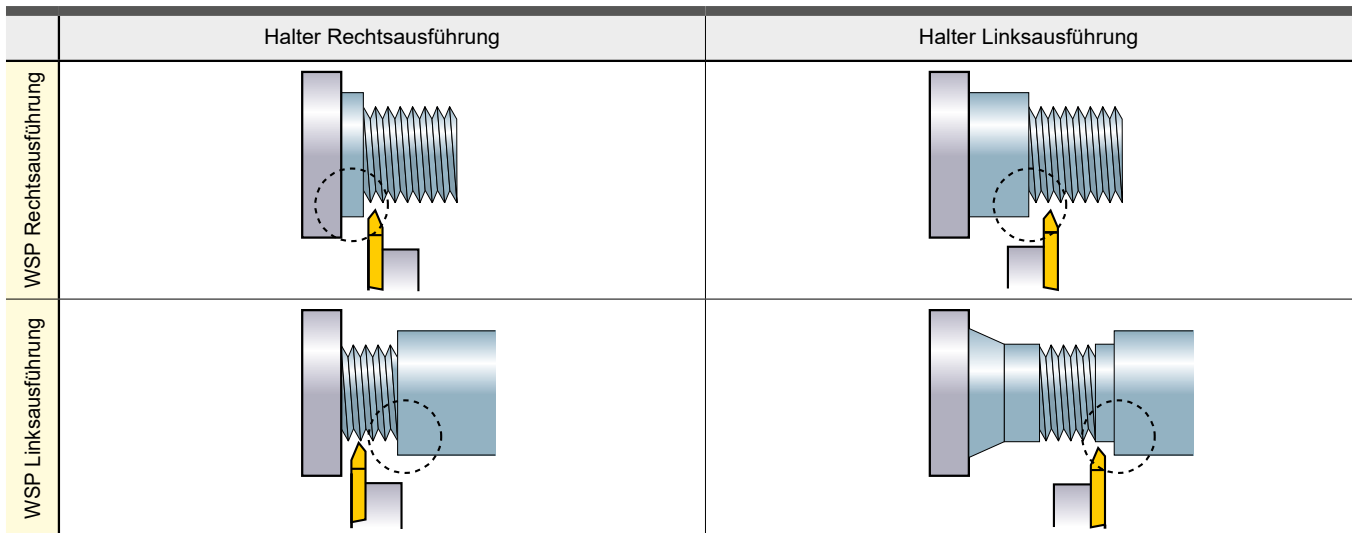

\*Die obigen Kombinationen ermöglichen die Bearbeitung der Seite von

## ÜBERSICHT GEWINDESCHNITTIEFEN

Möglicher Bearbeitungsbereich

Steigung (mm)	Gewindesteigung in (mm)										Anzahl der Durchgänge
	$\geq \phi 1.0$	$\geq \phi 1.2$	$\geq \phi 1.6$	$\geq \phi 2.0$	$\geq \phi 2.5$	$\geq \phi 3.0$	$\geq \phi 4.0$	$\geq \phi 5.0$	$\geq \phi 6.0$	$\geq \phi 7.0$	
0.2											2 – 4
0.25											3 – 5
0.3											4 – 6
0.35											5 – 7
0.4											6 – 8
0.45											
0.5											
0.6											
0.7											
0.75											
0.8											
1											
1.25											
1.5											

Gewindeschneiden  
nicht möglich

\*Metrisches Gewinde (60°)

Steigung (Gang/Zoll)	Gewindesteigung in									Anzahl der Durchgänge
Zoll	$\geq \phi 0.060$	$\geq \phi 0.073$	$\geq \phi 0.086$	$\geq \phi 0.099$	$\geq \phi 0.112$	$\geq \phi 0.164$	$\geq \phi 0.190$	$\geq \phi 0.250$	$\geq \phi 0.313$	
mm	$\geq \phi 1.524$	$\geq \phi 1.854$	$\geq \phi 2.184$	$\geq \phi 2.515$	$\geq \phi 2.845$	$\geq \phi 4.166$	$\geq \phi 4.826$	$\geq \phi 6.350$	$\geq \phi 7.938$	
80										3 – 5
72										4 – 6
64										5 – 7
56										
48										
44										
40										
32										
28										
26										
24										
20										
18										6 – 8
16										

Gewindeschneiden  
nicht möglich

\*Gewindeform UN-amerikanisch, Whitworth

ERSATZTEILE > N001  
TECHNISCHE DATEN > P001





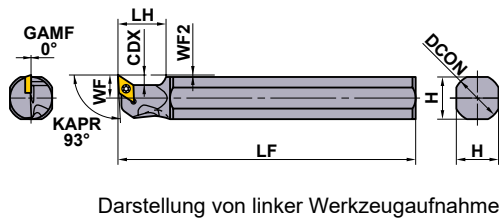
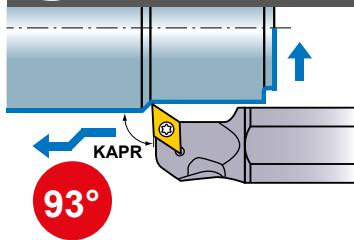

D025

# AUSSEN LÄNGSDREHEN, KOPIEREN, PLANDREHEN (FÜR REVOLVERMASCHINEN)

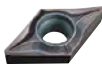
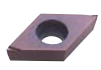
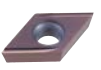
## SH

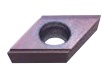

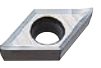
Darstellung von linker Werkzeugaufnahme.

Schichten SMG/FS	Schichten R-F	Leicht R-SS	Leicht LS
			
(07, 11)	(07, 11)	(07, 11)	(07, 11)
Mittel R-SN	Mittel R-SR	Für Nicht-Eisen Metalle AZ	Leicht LS-P
			
(07, 11)	(07, 11)	(07, 11)	(07, 11)

SMALL TOOLS

D

Bestellbezeichnung	Lager	WSP Bezeichnung	Abmessungen (mm)								* Spannschraube	Schlüssel
			DCON	LF	LH	H	WF	CDX	WF2			
SH16H-FSDUCL07	★	DCMT DCMW DCET DCGT DCGW	0702	15.875	100	20	14	7.75	4.2	0.75	TS254	TKY08R
SH19K-FSDUCL07	★			19.05	125	20	17	9.25	4.2	0.75	TS254	TKY08R
SH20K-FSDUCL07	★			20	125	20	18	9.75	4.2	0.75	TS254	TKY08R
SH22K-FSDUCL07	★			22	125	20	20	10.75	4.2	0.75	TS254	TKY08R
SH25M-FSDUCL07	★			25.4	150	20	23	12.25	4.2	0.75	TS254	TKY08R
SH16H-FSDUCL11	★	DCMT DCMW DCET DCGT DCGW	11T3	15.875	100	20	15	7.75	6.4	0.75	TS43	TKY15R
SH19K-FSDUCL11	★			19.05	125	20	17	9.25	6.4	0.75	TS43	TKY15R
SH20K-FSDUCL11	★			20	125	20	18	9.75	6.4	0.75	TS43	TKY15R
SH22K-FSDUCL11	★			22	125	20	20	10.75	6.4	0.75	TS43	TKY15R
SH25M-FSDUCL11	★			25.4	150	20	23	12.25	6.4	0.75	TS43	TKY15R

Hinweis 1) Bei Verwendung von linken und rechten Spanbrechern, verwenden Sie bitte WSP in Rechtsausführung.  
 Hinweis 2) Die Abbildungen der Wendeschneidplatten dienen nur als Beispiel. Die Buchstaben bezeichnen den Spanbrecher, und die Abmessung bezieht sich auf den Innenkreisdurchmesser.

\* Spannmoment (N • m) : TS254=1.0, TS43=3.5

## SCHNITTDATENEMPFEHLUNGEN

	Material	Härte	Sorte	Schnittgeschw. (m/min)	Vorschub (mm/U.)
P	C-Stahl, Leg. Stahl	180HB–280HB	MS6015/VP15TF	100 (50–150)	0.08 (0.01–0.15)
	Allg. Baustahl	–	MS6015	110 (30–180)	0.08 (0.01–0.15)
			NX2525	150 (50–250)	0.08 (0.01–0.15)
M	Rostfreier Stahl	≤200HB	VP15TF/MP9005/MP9015	80 (50–120)	0.06 (0.02–0.1)
		230HB	MS9025	100 (50–180)	0.08 (0.01–0.15)
N	Aluminiumlegierung	–	HTi10/MT9005	150 (70–230)	0.09 (0.03–0.15)
S	Titanlegierung	–	MT9005	60 (40–80)	0.08 (0.04–0.12)
	Hitzebeständiger Stahl	–	MP9015/MS9025	50 (20–75)	0.08 (0.04–0.12)

★ : Lagerstandard in Japan.

SH○○○ WSP

➤ A147–A152

CBN & PKD WSP

➤ B054, B055, B068

# Notizen

---

A series of horizontal dashed lines for writing notes, spanning the width of the page.



# ALLGEMEINE ERKLÄRUNG: DREHEN BOHRSTANGEN

## Wie sind die Seiten dieses Kapitels aufgebaut

- 1. Aufgelistet nach Produkksreien.  
(Beachten Sie das Inhaltsverzeichnis auf der nächsten Seite.)

### BOHRSTANGENAUSFÜHRUNG

Die ersten Buchstaben der Bestellbezeichnung, sowie der Anwendungsbereich wird aufgelistet.

### PRODUKTNAME

### PRODUKT KAPITEL

### PRODUKT-EIGENSCHAFTEN

### BOHRSTANGEN

## DIMPLE BAR

• Ausgerechneter Vibrationswiderstand durch den leichten Dimple-Kopf.  
 • Bessere Spannbrechereffektivität durch zusätzlichen Spannkopf.  
 • Laser gestrichelte Ausdragskallierung am Schaft (Stahlschaft).  
 • Plus ist bis für Durchmesser (Hintermaßschachtel mit 3x8 Durchmesser).

FSCLC/P/E

Bestellbezeichnung	WSP Bezeichnung	DCON	LF	LDRED	WF	H	GAMP	DMIN	Max. Empf. ist Verh.	Schichten	Leicht	Mittel
FSCLC1008RL-08E	0802	8	140	13,8	5	7,2	12°	10	7	TS253	TKY08F	
FSCLC1008R-08E-2/3	0802	8	90	13,8	5	7,2	12°	10	5	TS253	TKY08F	
FSCLC1008R-08E-1/2	0802	8	70	13,8	5	7,2	12°	10	3	TS253	TKY08F	
FSCLP1210RL-08E	0802	10	160	16,0	6	9	5°	12	7,5	TS250	TKY10F	
FSCLP1210R-08E-2/3	0802	10	105	16,0	6	9	5°	12	5	TS250	TKY10F	
FSCLP1210R-08E-1/2	0802	10	80	16,0	6	9	5°	12	3	TS250	TKY10F	
FSCLP1412RL-08E	0802	12	180	17,8	7	11	4°	14	8	TS250	TKY10F	
FSCLP1412R-08E-2/3	0802	12	120	17,8	7	11	4°	14	5	TS250	TKY10F	
FSCLP1412R-08E-1/2	0802	12	90	17,8	7	11	4°	14	3	TS250	TKY10F	
FSCLP1816RL-09E	0903	16	220	21,8	9	15	3,5°	18	8	TS240	TKY15F	
FSCLP1816R-09E-2/3	0903	16	145	21,8	9	15	3,5°	18	5	TS240	TKY15F	
FSCLP1816R-09E-1/2	0903	16	110	21,8	9	15	3,5°	18	3	TS240	TKY15F	
FSCLP2220RL-09E	0903	20	250	24,0	11	19	2°	22	8	TS310	TKY10F	
FSCLP2220R-09E-2/3	0903	20	165	24,0	11	19	2°	22	5	TS310	TKY10F	
FSCLP2220R-09E-1/2	0903	20	125	24,0	11	19	2°	22	3	TS310	TKY10F	

\*1 Spannmoment (N·m): TS253=1,0, TS250=2,5, TS240=3,5  
 \*2 Durch Wechsel der Spannschraube kann eine andere Wendschneidplatte verwendet werden. Siehe Seite E006.

### ABBILDUNG ZEIGT DEN ANWENDUNGSBEREICH

Die Abbildungen und Bearbeitungs Pfeile beschreiben die möglichen Bearbeitungsarten sowie den Anstellwinkel.

### ABBILDUNG

### SPANBRECHER ÜBERSICHT

## FSTUP

• Kühlmittelbohrung  
 • Schichten  
 • Leicht  
 • Mittel

Bestellbezeichnung	WSP Bezeichnung	DCON	LF	LDRED	WF	H	GAMP	DMIN	Max. Empf. ist Verh.	Schichten	Leicht	Mittel
FSTUP1008RL-08A	0802	8	125	16	5	7,2	10°	10	3	TS250	TKY08F	
FSTUP1210RL-09A	0902	10	150	22,5	6	9	8°	12	3,5	TS250	TKY08F	
FSTUP1412RL-09A	0902	12	150	27	7	11	7°	14	4	TS250	TKY08F	
FSTUP1816RL-11A	1103	16	180	36	9	15	4°	18	5	TS310	TKY10F	
FSTUP2220RL-11A	1103	20	220	45	11	19	0°	22	5	TS310	TKY10F	
FSTUP3228RL-16A	1603	25	270	56,3	16	23,4	0°	32	5	TS40	TKY15F	

\*1 Spannmoment (N·m): TS250=0,6, TS250=1,0, TS310=2,5, TS40=3,5  
 \*2 Durch Wechsel der Spannschraube kann eine andere Wendschneidplatte verwendet werden. Siehe Seite E006.

## FSTUP E

• HM-Schaft  
 • Kühlmittelbohrung  
 • Schichten  
 • Leicht  
 • Mittel

Bestellbezeichnung	WSP Bezeichnung	DCON	LF	LDRED	WF	H	GAMP	DMIN	Max. Empf. ist Verh.	Schichten	Leicht	Mittel
FSTUP1008RL-08E	0802	8	140	13,8	5	7,2	10°	10	7	TS250	TKY08F	
FSTUP1008R-08E-2/3	0802	8	90	13,8	5	7,2	10°	10	5	TS250	TKY08F	
FSTUP1008R-08E-1/2	0802	8	70	13,8	5	7,2	10°	10	3	TS250	TKY08F	
FSTUP1210RL-09E	0902	10	160	16,0	6	9	8°	12	7,5	TS250	TKY08F	
FSTUP1210R-09E-2/3	0902	10	105	16,0	6	9	8°	12	5	TS250	TKY08F	
FSTUP1210R-09E-1/2	0902	10	80	16,0	6	9	8°	12	3	TS250	TKY08F	
FSTUP1412RL-09E	0902	12	180	17,8	7	11	7°	14	8	TS250	TKY08F	
FSTUP1412R-09E-2/3	0902	12	120	17,8	7	11	7°	14	5	TS250	TKY08F	
FSTUP1412R-09E-1/2	0902	12	90	17,8	7	11	7°	14	3	TS250	TKY08F	
FSTUP1816RL-11E	1103	16	220	21,8	9	15	4°	18	8	TS310	TKY10F	
FSTUP1816R-11E-2/3	1103	16	145	21,8	9	15	4°	18	5	TS310	TKY10F	
FSTUP1816R-11E-1/2	1103	16	110	21,8	9	15	4°	18	3	TS310	TKY10F	
FSTUP2220RL-11E	1103	20	250	24,0	11	19	0°	22	8	TS310	TKY10F	
FSTUP2220R-11E-2/3	1103	20	165	24,0	11	19	0°	22	5	TS310	TKY10F	
FSTUP2220R-11E-1/2	1103	20	125	24,0	11	19	0°	22	3	TS310	TKY10F	

\*1 Spannmoment (N·m): TS250=0,6, TS250=1,0, TS310=2,5  
 \*2 Durch Wechsel der Spannschraube kann eine andere Wendschneidplatte verwendet werden. Siehe Seite E006.

Anmerkung 1) Die Fotos der Wendschneidplatten dienen lediglich als Beispiel. Die Buchstaben beziehen sich auf den Spannbrecher und die Abmessungen auf den Innendurchmesser.  
 Anmerkung 2) Die angegebenen Maße gelten für Wendschneidplatten mit Eckenradius RE 0,4. Artikel von 1. Buchstabe mit RE 0,6.  
 Anmerkung 3) Bei der Verwendung von Wendschneidplatten mit rechtsseitigem und linksseitigem Spannbrecher verwenden Sie bitte den linksseitigen Spannbrecher für den rechten Halter und den rechtsseitigen Spannbrecher für den linken Halter.

**E008**

• Lagerstandard. \* : Lagerstandard in Japan.  
 CP: WSP → A138-A145  
 CBN & PKD WSP → B081-B083, B087

**E009**

TP: WSP → A162, A163  
 CBN & PKD WSP → B087, B088, B090

SCHRITTBEZUGEN → E014  
 ERSATZTEILE → N001  
 TECHNISCHE DATEN → P001

**LEGENDE FÜR LAGERSYMBOL**

Wird auf jeder Doppelseite auf der linken Seite gezeigt.

**STANDARDPRODUKTE**

Beinhaltet Bestellbezeichnung, Lagerstatus Rechts/Links WSP, Abmessungen, mind. Durchmesser, Standard-Eckenradius, empfohlene L/D Verhältnis (max.) und Ersatzteile.

**MINDEST BEARBEITUNGSDURCHMESSER**

Ist farblich unterlegt, um schnell das richtige Werkzeug zu finden.

**QUERVERWEISE VERFÜGBARE WSP**

Weist auf weitere detaillierte Produktinformationen der verschiedenen WSP-Ausführungen hin.

**QUERVERWEIS AUF ANDERE SEITEN**

- ERSATZTEILE
- TECHNISCHE DATEN

Beinhaltet Querverweise für alle auf dieser Doppelseite aufgeführten Produkte.

# DREHEN

# BOHRSTANGEN

KLASSIFIKATION DER BOHRSTANGEN .....	E002
IDENTIFIKATION .....	E004

## STANDARD BOHRSTANGEN

EIGENSCHAFTEN DER DIMPLE BAR .....	E006
DIMPLE BAR .....	E007
DOPPEL KLEMM DIMPLE BAR .....	E015
MICRO-DEX BOHRSTANGEN .....	E018
MICRO-MINI TWIN BOHRSTANGEN .....	E021
MICRO-MINI BOHRSTANGEN .....	E024
F-AUSFÜHRUNG BOHRSTANGEN .....	E027
S-AUSFÜHRUNG BOHRSTANGEN .....	E030
P-AUSFÜHRUNG BOHRSTANGEN .....	E037
AL- AUSFÜHRUNG BOHRSTANGEN .....	E041

### \*Alphabetisches Inhaltsverzeichnis

E015 A○○○-DCLN	E019 C○○○STUC	E020 RBH
E015 A○○○-DDUN	E034 C○○○SVQC	E025 RBH
E016 A○○○-DSKN	E018 C○○○SWUB	E032 S○○○SCLC
E016 A○○○-DTFN	E021 CB	E036 S○○○SCZC
E017 A○○○-DVUN	E022 CR	E033 S○○○SDQC
E017 A○○○-DWLN	E028 FCTU1	E031 S○○○SDUC
E038 A○○○PCLN	E028 FCTU2	E035 S○○○SSKC
E039 A○○○PDQN	E007 FSCLC/P	E030 S○○○STFC
E038 A○○○PDUN	E011 FSDQC	E041 S○○○STFE
E040 A○○○PDZN	E010 FSDUC	E034 S○○○SVQC
E037 A○○○PSKN	E027 FSTU1	E035 S○○○SVUC
E037 A○○○PTFN	E027 FSTU2	E026 SBH
E039 A○○○PWLN	E009 FSTUP	
E024 C○○○-BLS	E014 FSVJB/C	
E018 C○○○SCLC	E013 FSVPB/C	
E032 C○○○SCLC	E013 FSVUB/C	
E033 C○○○SDQC	E029 FSWL1	
E031 C○○○SDUC	E029 FSWL2	
E030 C○○○STFC	E012 FSWUB/P	



# KLASSIFIKATION

Halterbezeichnung	DMIN Min. Durchmesser	Eigenschaften	KAPR=75°	KAPR=91°	KAPR=93°			
<b>MICRO-MINI TWIN Bohrstangen</b> 	ø2.2 - ø8.2	<ul style="list-style-type: none"> <li>Vollhartmetall Ausführung mit 2 Scheidkanten.</li> <li>Für das Plan- und Kopierdrehen.</li> <li>Mit und ohne Spanbrecher.</li> </ul>						
<b>MICRO-MINI TWIN Bohrstangen</b> 	ø3.2 - ø5.2	<ul style="list-style-type: none"> <li>Vollhartmetall (eine Schneidkante).</li> <li>l/d ist 5x Durchmesser.</li> <li>Schneidkante kann modifiziert werden, dadurch für einen breiten Anwendungsbereich geeignet (Schneiden, Stechen, Kopieren, etc.).</li> </ul>						
<b>MICRO-DEX Bohrstangen (Hartmetallschaft)</b> 	ø5 - ø8	<ul style="list-style-type: none"> <li>5°, 7° positive WSP.</li> <li>Hartmetallschaft.</li> <li>Einfache Handhabung.</li> <li>Geeignet für kleine Werkstücke.</li> <li>l/d ist 5x Durchmesser.</li> </ul>			 <b>SWUB</b> ↻ E018	 <b>STUC</b> ↻ E019		
<b>F-Ausführung Bohrstangen</b> 	ø5.8 - ø40	<ul style="list-style-type: none"> <li>11° positive WSP.</li> <li>Schraub- und Spannfingerklemmung.</li> <li>l/d ist 3 bis 5x Durchmesser.</li> <li>FSWL hat 7° positive WSP.</li> </ul>			 <b>FSTU</b> ↻ E027	 <b>FCTU</b> ↻ E028		
<b>DIMPLE BAR</b> 	ø10 - ø40	<ul style="list-style-type: none"> <li>5°, 7°, 11° positive WSP.</li> <li>Ausgezeichneter Vibrationswiderstand durch den leichten Dimple-Kopf.</li> <li>l/d ist 3 bis 5x Durchmesser (Hartmetallschaft ist 3-8x Durchmesser).</li> </ul>			 <b>FSTUP</b> ↻ E009	 <b>FSDUC</b> ↻ E010	 <b>FSVUB/C</b> ↻ E013	 <b>FSWUB/P</b> ↻ E012
<b>S-Ausführung Bohrstangen</b> 	ø11 - ø50	<ul style="list-style-type: none"> <li>ISO Standard.</li> <li>7° positive WSP.</li> <li>Schraubklemmung.</li> <li>l/d ist 3 bis 5x Durchmesser (Hartmetallschaft ist 7-8x Durchmesser).</li> </ul>	 <b>SSKC</b> ↻ E035	 <b>STFC</b> ↻ E030	 <b>SDUC</b> ↻ E031	 <b>SVUC</b> ↻ E035		
<b>AL- Ausführung (Für Aluminiumlegierung)</b> 	ø20 - ø32	<ul style="list-style-type: none"> <li>Geeignet für Nichteisenmetall.</li> <li>20° positive WSP.</li> <li>Schraubklemmung.</li> <li>l/d ist 6x Durchmesser.</li> <li>Sehr guter Vibrationswiderstand.</li> </ul>		 <b>STFE</b> ↻ E041				
<b>P-Ausführung Bohrstangen</b> 	ø20 - ø70	<ul style="list-style-type: none"> <li>ISO Standard.</li> <li>Wirtschaftliche neagtive WSP.</li> <li>Kniehebelklemmung und Excenterspannung.</li> <li>l/d ist 3x Durchmesser.</li> </ul>	 <b>PSKN</b> ↻ E037	 <b>PTFN</b> ↻ E037	 <b>PDUN</b> ↻ E038			
<b>DOPPEL KLEMM DIMPLE BAR</b> 	ø32 - ø50	<ul style="list-style-type: none"> <li>Wirtschaftliche neagtive WSP.</li> <li>Einschritttyp.</li> <li>Ausgezeichneter Vibrationswiderstand durch den leichten Dimple-Kopf. (Mit Kühlmittelbohrung.)</li> <li>l/d ist 3 bis 4x Durchmesser.</li> </ul>	 <b>DSKN</b> ↻ E016	 <b>DTFN</b> ↻ E016	 <b>DDUN</b> ↻ E015	 <b>DVUN</b> ↻ E017		

Hinweis 1) Werkzeuge mit blauem Symbol haben einen vibrationsreduzierenden Schaft.

(MICRO-DEX Bohrstangen sind nur mit Hartmetallschaft lieferbar)

Hinweis 2) l/d steht für das Längen-Durchmesser-Verhältnis. l zu der Schneidkante und dem Schaftdurchmesser d.

E

BOHRSTANGEN

	KAPR=94°	KAPR=95°	KAPR=107.5°–117.5°	KAPR=142°	KAPR=3°,5°	Standard Auswahl							
						Rationell	Geringer Schnittwiderstand (schmale WSP)	Spannfähigkeit (WSP)	Vibrationswiderstand	Leistungsstrehen	Kühlmittelbohrung	Sonderanwendung	Kleinertfertigung
		 CBORS(-B) E021		 CR E022			○		○*				○
	 COOFR-BLS E024						○						○
		 SCLC E018							○*				○
		 FSWL E029					○		○*				○
		 FSCLC/P E007	 FSDQC E011	 FSVPB/C E013	 FSVJB/C E014		○		○*	○*			
		 SCLC E032	 SDQC E033	 SVQC E034	 SCZC E036		○		○*				
							○		○			○	
	 PCLN E038	 PWLN E039	 PDQN E039		 PDZN E040		○	○		○	○		
	 DCLN E015	 DWLN E017											

Hinweis 3) ○: 1. Empfehlung, ○: 2. Empfehlung.  
Hinweis 4) \* Schaftausführung aus Vollhartmetall.

# IDENTIFIKATION

■ ISO CODE für Ausdrehwerkzeuge für die Innenbearbeitung

BOHRSTANGEN

A	● Halter mit Kühlmittelbohrung
	● Stahlschaft
C	● Vollhartmetallschaft
E	● Halter mit Kühlmittelbohrung
	● Vollhartmetallschaft
S	● Stahlschaft

08	φ 8	F	80
10	φ 10	H	100
12	φ 12	K	125
16	φ 16	M	150
20	φ 20	Q	180
25	φ 25	R	200
32	φ 32	S	250
40	φ 40	T	300
50	φ 50	U	350
		V	400

① Schaftausführung

② Schaftdurchmesser DCON (mm)

③ Werkzeuglänge LF (mm)

M

P

S

④ Klemmsystem

S 16 M S C L C R 09

⑤ WSP-Form		⑥ Werkzeug-Typ		⑦ WSP-Freiwinkel		⑨ WSP-Größe									
C		F		C		Inkreis- durchmesser der WSP (mm)	C	D	S	T	V	W			
D		K		E											
S		L		N			3.97	—	—	—	—	—	02		
T		Q		P			4.76	—	—	—	—	—	—		
V		U					5.56	—	—	09	—	—	L3		
W		Z					6.35	06	07	—	11	11	04		
							7.94	08	—	—	—	—	—		
						9.525	09	11	09	16	16	06			
						12.70	12	15	12	22	—	08			
						15.875	16	—	—	—	—	—			
						19.05	19	—	19	—	—	—			

⑧ Bearbeitungsrichtung

R	
L	

## ■ DIMPLE BAR

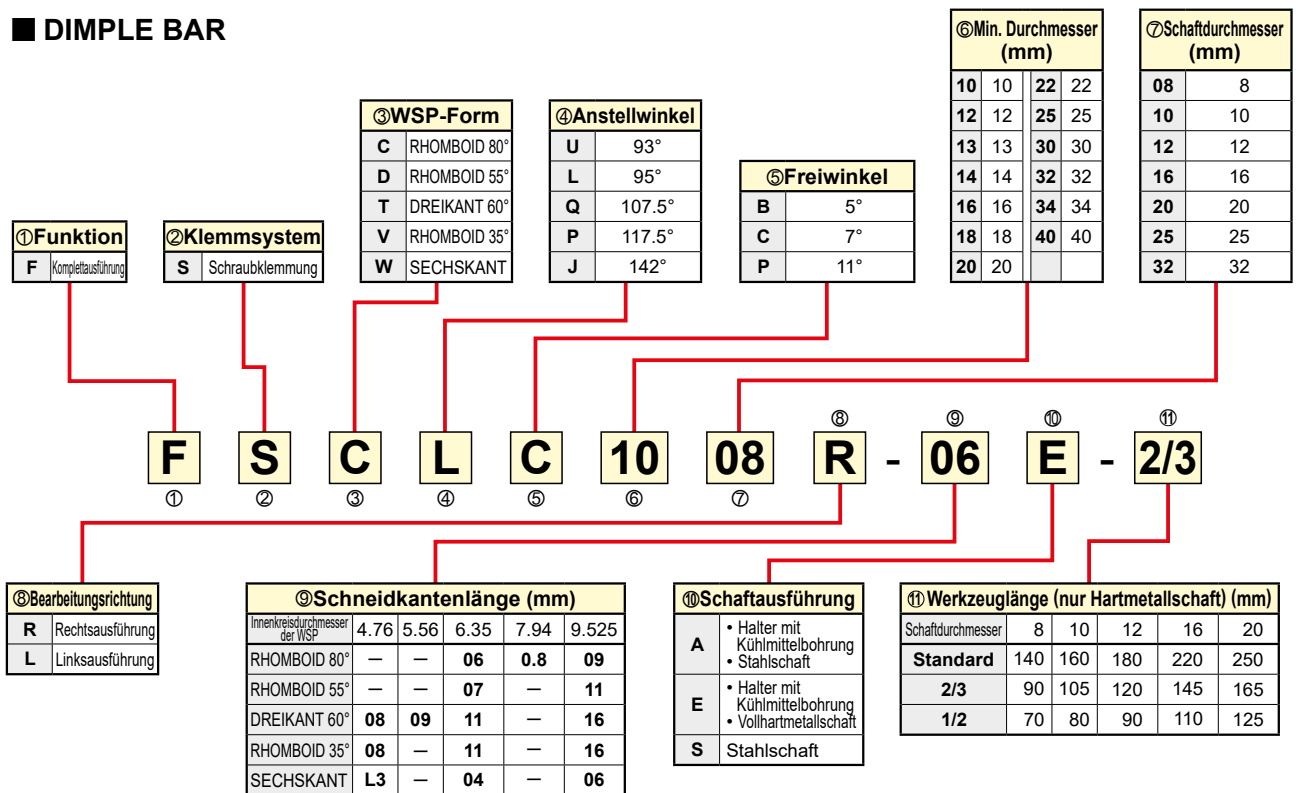

## ■ F-Ausführung Bohrstanzen

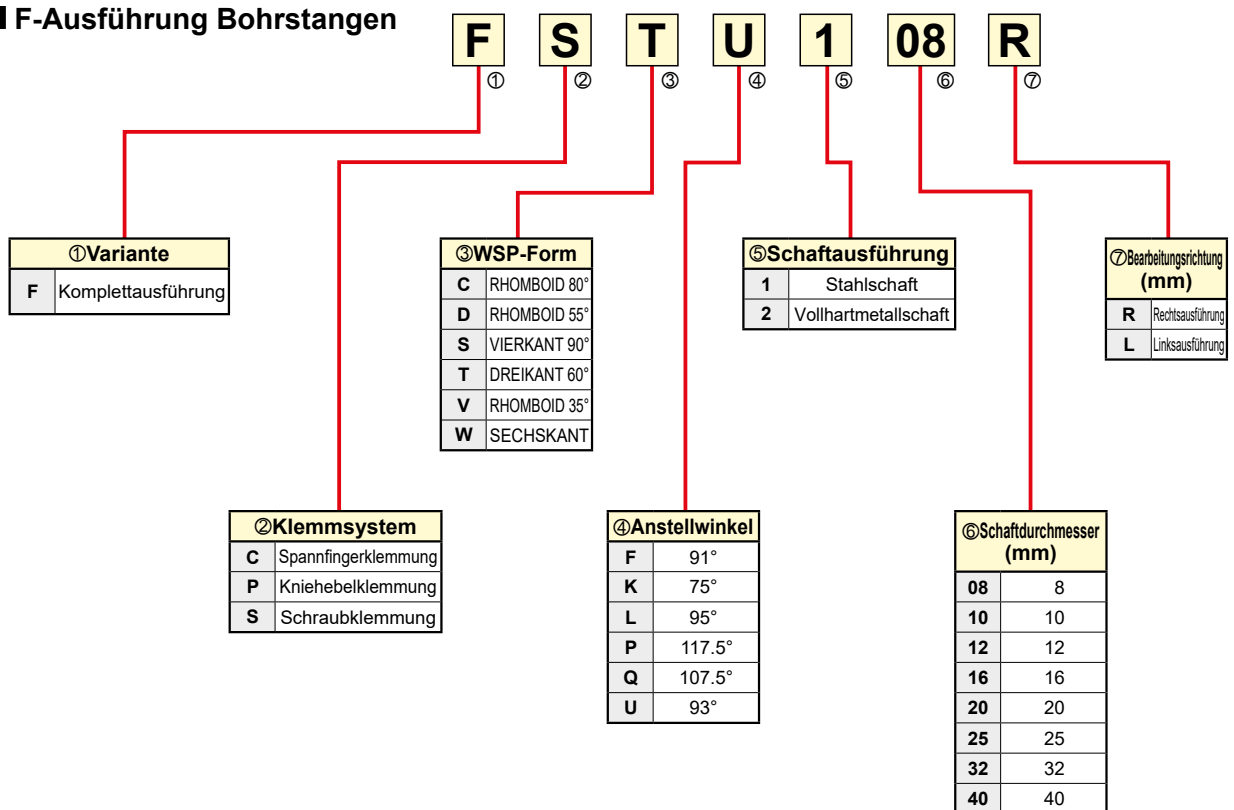

# EIGENSCHAFTEN DER DIMPLE BAR

Sehr stabiler Stahlschaft und leichter Dimple-Kopf. Reduzierung von Rattern und verbesserte Dämpfungseigenschaften durch computergestützte Vibrationsanalyse.

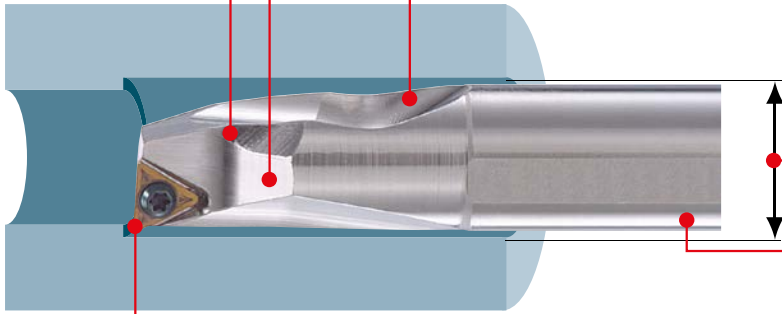

Bessere Spankontrolle/-abfuhr, durch zusätzlichen Spankanal.

Der gewichtsreduzierte Kopf mit großen Aussparungen reduziert das Vibrieren.

Auch verfügbar in kleineren Durchmessern als ISO-Standard.

Bohrstangen mit Skalierung am Schaft für einfache Einstellung in der Maschine oder Einstellgerät.

F und FS Spanbrecher erzeugen im Schlichten eine sehr gute Oberflächengüte, der MV Spanbrecher ermöglicht eine sehr gute Spanabfuhr. Extrem verschleißfeste PCBN-WSP für die Bearbeitung von gehärteten Materialien stehen auch zur Verfügung.

E

BOHRSTANGEN

## VIBRATIONSWIDERSTAND

### ● DIMPLE BAR

Kopfgewicht	Abklingzeit
49.7g	15.8ms



Bei Reduzierung des Kopfgewichtes, werden die Schwingungen deutlich reduziert.

### ● Herkömmliches Produkt

Kopfgewicht	Abklingzeit
70.1g	20ms



\* Die hier abgebildeten Ergebnisse wurden mit einer FSCLP1816R-09A unter folgenden Schnittbedingungen durchgeführt:  
l/d= 5, Schnitttiefe= 0.5 mm, Vorschub= 0.05 mm/U.

## Anleitung für die Nutzung von Wendeschneidplatten des Typs CCG/MT • CPG/MT • CPMX • TPG/MX

Durch Wechsel der Spannschraube können die in der folgenden Tabelle aufgelisteten Wendeschneidplatten verwendet werden.

### Halter : FSCLC/P • FSCLC/P...E

WSP Bezeichnung	Spannschraube
CCG/MT0602 (φ 6.35)	Kompatibel
CPG/MT0802 (φ 7.94)	Wechseln in TS3
CPG/MT0903 (φ 9.525)	Wechseln in TS4
CPMX0802 (φ 7.94)	Kompatibel
CPMX0903 (φ 9.525)	Kompatibel

### Halter : FSTUP • FSTUP...E

WSP Bezeichnung	Spannschraube
TPG/MX0802 (φ 4.76)	Wechseln in CS200T
TPG/MX0902 (φ 5.56)	Wechseln in CS250T
TPG/MX1103 (φ 6.35)	Wechseln in CS300890T

\* Wenn die Schraube zu lang ist, kürzen Sie diese bitte nach Bedarf.

Hinweis 1) Die Typen TPMT/W09, W11 können aufgrund einer abweichenden Klemmschraubengröße nicht verwendet werden.

# DIMPLE BAR

- Ausgezeichneter Vibrationswiderstand durch den leichten Dimple-Kopf.
- Bessere Spankontrolle/-abfuhr durch einen zusätzlichen Spankanal.
- Laser gedruckte Auskragskalierung am Schaft. (Stahlschaft).
- l/d ist 3 bis 5x Durchmesser (Hartmetallschaft ist 3-8x Durchmesser).

## FSCLC/P

## CC<sup>○</sup>WSP, CP<sup>○</sup>WSP

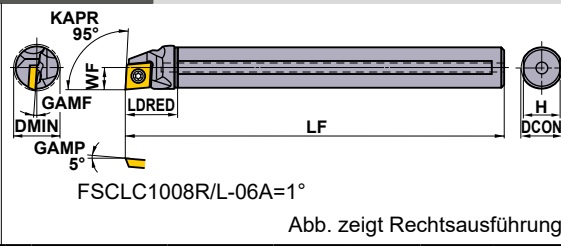
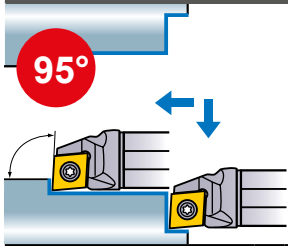

Schichten	Schichten	Schichten	Leicht
FP	FV	FM	SV
(06)	(06,08,09)	(06)	(06,08,09)
Leicht	Mittel	Mittel	PCBN/PKD
LP	MV	MP	
(06)	(06,08,09)	(06)	(06,08,09)

Abb. zeigt Rechtsausführung.

Bestellbezeichnung	Kühlmittelbohrung	Lager		WSP Bezeichnung	Abmessungen (mm)						Max. Empf. l/d Verh.	*1			
		R	L		DCON	LF	LDRED	WF	H	GAMF		DMIN	Spannschraube	Schlüssel	
FSCCLC1008R/L-06A	○	●	●	CC <sup>○</sup> B/H/T/W	0602 <sup>○</sup>	8	125	18	5	7.2	12°	10	3	TS253	TKY08F
FSCLP1210R/L-08A	○	●	●	CPMB CPMH CPMT*2 CPMX*2 CPGB CPGT*2	0802 <sup>○</sup>	10	150	22.5	6	9	5°	12	3.5	TS3D	TKY10F
FSCLP1210R/L-08S	-	★	★		0802 <sup>○</sup>	10	150	22.5	6	9	5°	12	3.5	TS3D	TKY10F
FSCLP1412R/L-08A	○	●	●		0802 <sup>○</sup>	12	150	27	7	11	4°	14	4	TS3D	TKY10F
FSCLP1816R/L-09A	○	●	●		0903 <sup>○</sup>	16	180	36	9	15	3.5°	18	5	TS4D	TKY15F
FSCLP2220R/L-09A	○	●	●		0903 <sup>○</sup>	20	220	45	11	19	2°	22	5	TS4D	TKY15F
FSCLP2220R-09S	-	★			0903 <sup>○</sup>	20	220	45	11	19	2°	22	5	TS4D	TKY15F
FSCLP3025R/L-09A	○	●	●		0903 <sup>○</sup>	25	250	56.3	15	23.4	0°	30	5	TS4D	TKY15F
FSCLP3025R-09S	-	★			0903 <sup>○</sup>	25	250	56.3	15	23.4	0°	30	5	TS4D	TKY15F

\*1 Spannmoment (N • m) : TS253=1.0, TS3D=2.5, TS4D=3.5

\*2 Durch Wechsel der Spannschraube kann ein andere Wendeschneidplatte verwendet werden. Siehe Seite E006.

Hinweis 1) Die Fotos der Wendeschneidplatten dienen lediglich als Beispiel. Die Buchstaben beziehen sich auf den Spanbrecher und die Abmessungen auf den Innenkreisdurchmesser.

Hinweis 2) Bei der Verwendung von Wendeschneidplatten mit rechtsseitigem und linksseitigem Spanbrecher verwenden Sie bitte den linksseitigen Spanbrecher für den rechten Halter und den rechtsseitigen Spanbrecher für den linken Halter.

- : Lagerstandard.
- ★ : Lagerstandard in Japan.

CC <sup>○</sup> WSP	> A139 – A145
CP <sup>○</sup> WSP	> A146
PCBN & PKD WSP	> B051 – B053, B067

SCHNITTBEDINGUNGEN	> E014
ERSATZTEILE	> N001
TECHNISCHE DATEN	> P001



# DIMPLE BAR

- Ausgezeichneter Vibrationswiderstand durch den leichten Dimple-Kopf.
- Bessere Spankontrolle/-abfuhr durch einen zusätzlichen Spankanal.
- Laser gedruckte Auskragskalierung am Schaft. (Stahlschaft).
- l/d ist 3 bis 5x Durchmesser (Hartmetallschaft ist 3-8x Durchmesser).

## FSCLC/P.E

HM-Schaft mit Kühlmittelbohrung CC $\odot$ WSP, CP $\odot$ WSP

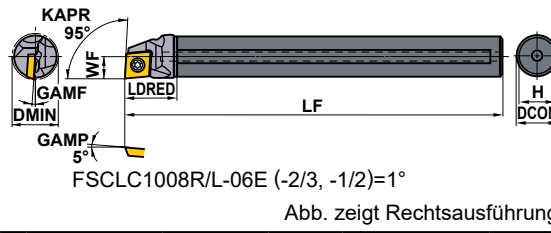
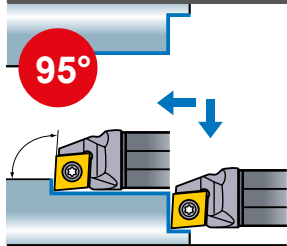

Schichten	Schichten	Schichten	Leicht
FP	FV	FM	SV
(06)	(06,08,09)	(06)	(06,08,09)
Leicht	Mittel	Mittel	PCBN/PKD
LP	MV	MP	
(06)	(06,08,09)	(06)	(06,08,09)

Bestellbezeichnung	Lager		WSP Bezeichnung	Abmessungen (mm)							Max. Empf. l/d Verh.	*1		
	R	L		DCON	LF	LDRED	WF	H	GAMF	DMIN		Spannschraube	Schlüssel	
FSCLC1008R/L-06E	●	●	CC $\odot$ B	0602 $\odot$	8	140	13.8	5	7.2	12°	10	7	TS253	TKY08F
FSCLC1008R-06E-2/3	●		CC $\odot$ H CC $\odot$ T	0602 $\odot$	8	90	13.8	5	7.2	12°	10	5	TS253	TKY08F
FSCLC1008R-06E-1/2	●		CC $\odot$ T CC $\odot$ W	0602 $\odot$	8	70	13.8	5	7.2	12°	10	3	TS253	TKY08F
FSCLP1210R/L-08E	●	●	CPMB CPMH CPMT *2 CPMX *2 CPGB CPGT *2	0802 $\odot$	10	160	16.0	6	9	5°	12	7.5	TS3D	TKY10F
FSCLP1210R-08E-2/3	●			0802 $\odot$	10	105	16.0	6	9	5°	12	5	TS3D	TKY10F
FSCLP1210R-08E-1/2	●			0802 $\odot$	10	80	16.0	6	9	5°	12	3	TS3D	TKY10F
FSCLP1412R/L-08E	●	●		0802 $\odot$	12	180	17.8	7	11	4°	14	8	TS3D	TKY10F
FSCLP1412R-08E-2/3	●			0802 $\odot$	12	120	17.8	7	11	4°	14	5	TS3D	TKY10F
FSCLP1412R-08E-1/2	●			0802 $\odot$	12	90	17.8	7	11	4°	14	3	TS3D	TKY10F
FSCLP1816R/L-09E	●	●		0903 $\odot$	16	220	21.8	9	15	3.5°	18	8	TS4D	TKY15F
FSCLP1816R-09E-2/3	●			0903 $\odot$	16	145	21.8	9	15	3.5°	18	5	TS4D	TKY15F
FSCLP1816R-09E-1/2	●			0903 $\odot$	16	110	21.8	9	15	3.5°	18	3	TS4D	TKY15F
FSCLP2220R/L-09E	●	●		0903 $\odot$	20	250	24.0	11	19	2°	22	8	TS4D	TKY15F
FSCLP2220R-09E-2/3	★			0903 $\odot$	20	165	24.0	11	19	2°	22	5	TS4D	TKY15F
FSCLP2220R-09E-1/2	★			0903 $\odot$	20	125	24.0	11	19	2°	22	3	TS4D	TKY15F

\*1 Spannmoment (N • m) : TS253=1.0, TS3D=2.5, TS4D=3.5

\*2 Durch Wechsel der Spannschraube kann eine andere Wendeschneidplatte verwendet werden. Siehe Seite E006.

Hinweis 1) Die Fotos der Wendeschneidplatten dienen lediglich als Beispiel. Die Buchstaben beziehen sich auf den Spanbrecher und die Abmessungen auf den Innendurchmesser.

Hinweis 2) Die angegebenen Maße gelten für Wendeschneidplatten mit Eckenradius RE 0.4. Artikel von ☆ Beschriftet mit RE 0.8)

Hinweis 3) Bei der Verwendung von Wendeschneidplatten mit rechtsseitigem und linksseitigem Spanbrecher verwenden Sie bitte den linksseitigen Spanbrecher für den rechten Halter und den rechtsseitigen Spanbrecher für den linken Halter.

BOHRSTANGEN

E

● : Lagerstandard. ★ : Lagerstandard in Japan.

CC $\odot$ WSP	> A139–A145
CP $\odot$ WSP	> A146
PCBN & PKD WSP	> B051–B053, B067

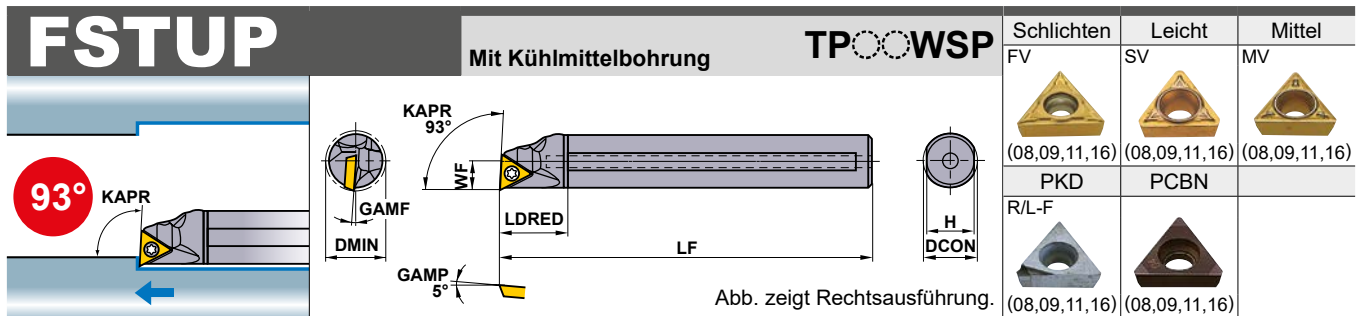

Bestellbezeichnung	Lager		WSP Bezeichnung	Abmessungen (mm)							Max. Empf. l/d Verh.	*1		
	R	L		DCON	LF	LDRED	WF	H	GAMP	DMIN		Spannschraube	Schlüssel	
FSTUP1008R/L-08A	●	●	TPMB TPMH TPMX*2 TPGB TPGH TPGX*2	0802	8	125	18	5	7.2	10°	10	3	TS2D	TKY06F
FSTUP1210R/L-09A	●	●		0902	10	150	22.5	6	9	8°	12	3.5	TS25D	TKY08F
FSTUP1412R/L-09A	●	●		0902	12	150	27	7	11	7°	14	4	TS25D	TKY08F
FSTUP1816R/L-11A	●	●		1103	16	180	36	9	15	4°	18	5	TS31D	TKY10F
FSTUP2220R/L-11A	●	●		1103	20	220	45	11	19	0°	22	5	TS31D	TKY10F
FSTUP3225R/L-16A <sup>*</sup>	●	●		1603	25	270	56.3	16	23.4	0°	32	5	TS4D	TKY15F

\*1 Spannmoment (N · m) : TS2D=0.6, TS25D=1.0, TS31D=2.5, TS4D=3.5

\*2 Durch Wechsel der Spannschraube kann eine andere Wendeschneidplatte verwendet werden. Siehe Seite E006.

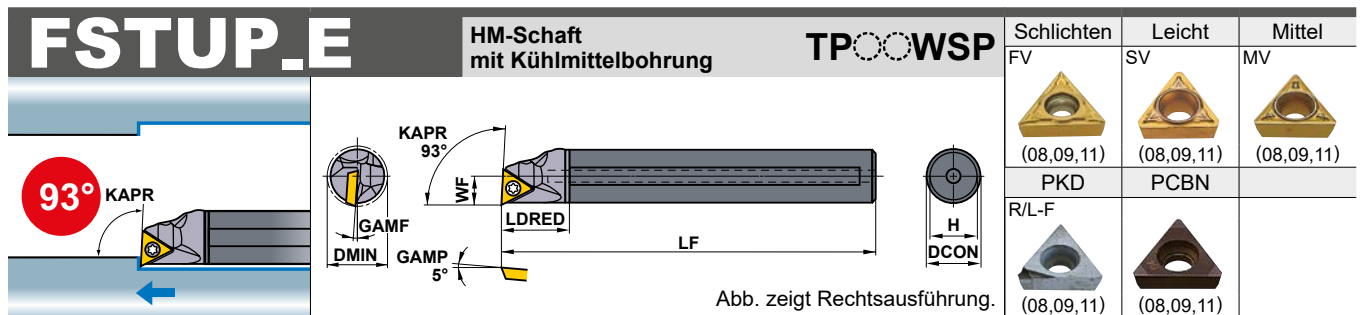

Bestellbezeichnung	Lager		WSP Bezeichnung	Abmessungen (mm)							Max. Empf. l/d Verh.	*1		
	R	L		DCON	LF	LDRED	WF	H	GAMP	DMIN		Spannschraube	Schlüssel	
FSTUP1008R/L-08E	●	●	TPMB TPMH TPMX*2 TPGB TPGH TPGX*2	0802	8	140	13.8	5	7.2	10°	10	7	TS2D	TKY06F
FSTUP1008R-08E-2/3	●	●		0802	8	90	13.8	5	7.2	10°	10	5	TS2D	TKY06F
FSTUP1008R-08E-1/2	●	●		0802	8	70	13.8	5	7.2	10°	10	3	TS2D	TKY06F
FSTUP1210R/L-09E	●	●		0902	10	160	16.0	6	9	8°	12	7.5	TS25D	TKY08F
FSTUP1210R-09E-2/3	●	●		0902	10	105	16.0	6	9	8°	12	5	TS25D	TKY08F
FSTUP1210R-09E-1/2	●	●		0902	10	80	16.0	6	9	8°	12	3	TS25D	TKY08F
FSTUP1412R/L-09E	●	●		0902	12	180	17.8	7	11	7°	14	8	TS25D	TKY08F
FSTUP1412R-09E-2/3	●	●		0902	12	120	17.8	7	11	7°	14	5	TS25D	TKY08F
FSTUP1412R-09E-1/2	●	●		0902	12	90	17.8	7	11	7°	14	3	TS25D	TKY08F
FSTUP1816R/L-11E	●	●		1103	16	220	21.8	9	15	4°	18	8	TS31D	TKY10F
FSTUP1816R-11E-2/3	●	●		1103	16	145	21.8	9	15	4°	18	5	TS31D	TKY10F
FSTUP1816R-11E-1/2	●	●		1103	16	110	21.8	9	15	4°	18	3	TS31D	TKY10F
FSTUP2220R/L-11E	●	●		1103	20	250	24.0	11	19	0°	22	8	TS31D	TKY10F
FSTUP2220R-11E-2/3	●	●		1103	20	165	24.0	11	19	0°	22	5	TS31D	TKY10F
FSTUP2220R-11E-1/2	●	●		1103	20	125	24.0	11	19	0°	22	3	TS31D	TKY10F

\*1 Spannmoment (N · m) : TS2D=0.6, TS25D=1.0, TS31D=2.5

\*2 Durch Wechsel der Spannschraube kann eine andere Wendeschneidplatte verwendet werden. Siehe Seite E006.

TPWSP > A162, A163  
PCBN & PKD WSP > B057, B058, B070

SCHNITTBEDINGUNGEN > E014  
ERSATZTEILE > N001  
TECHNISCHE DATEN > P001

# BOHRSTANGEN

## DIMPLE BAR

- Ausgezeichneter Vibrationswiderstand durch den leichten Dimple-Kopf.
- Bessere Spankontrolle/-abfuhr durch einen zusätzlichen Spankanal.
- Laser gedruckte Auskragskalierung am Schaft. (Stahlschaft).
- l/d ist 3 bis 5x Durchmesser (Hartmetallschaft ist 3-8x Durchmesser).

### FSDUC

### DC $\odot$ WSP

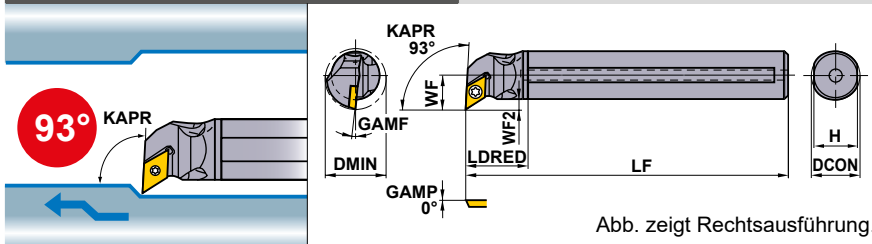

Schichten	Schichten	Leicht	Leicht
FP (07,11)	FM (07,11)	LP (07,11)	LM (07,11)
Mittel	Mittel	PKD	PCBN
MP (07,11)	MM (07,11)	R/L-F (07,11)	(07,11)

Bestellbezeichnung	Kühlmittelbohrung	Lager		WSP Bezeichnung	Abmessungen (mm)							Max. Empf. l/d Verh.	* Spannschraube	Schlüssel		
		R	L		DCON	LF	LDRED	WF	WF2	H	GAMF				DMIN	
FSDUC1410R/L-07A	○	●	●	DCMT DCMW DCGT DCGW	0702 $\odot$	10	150	18	8.3	3.3	9	7.5°	14	3.5	TS25	TKY08F
<b>NEW</b> FSDUC1410L-07S	—	★	★		0702 $\odot$	10	150	18	8.3	3.3	9	7.5°	14	3.5	TS25	TKY08F
FSDUC1612R/L-07A	○	●	●		0702 $\odot$	12	150	20	9.3	3.3	11	6°	16	4	TS25	TKY08F
FSDUC2016R/L-07A	○	●	●		0702 $\odot$	16	180	20	11.3	3.3	15	5°	20	5	TS25	TKY08F
FSDUC3220R/L-11A ☆	○	●	●		11T3 $\odot$	20	180	22.5	16.1	6.1	19	5°	32	5	TS43	TKY15F

\* Spannmoment (N · m) : TS25=1.0, TS43=3.5

BOHRSTANGEN

### FSDUC\_E

### HM-Schaft mit Kühlmittelbohrung DC $\odot$ WSP

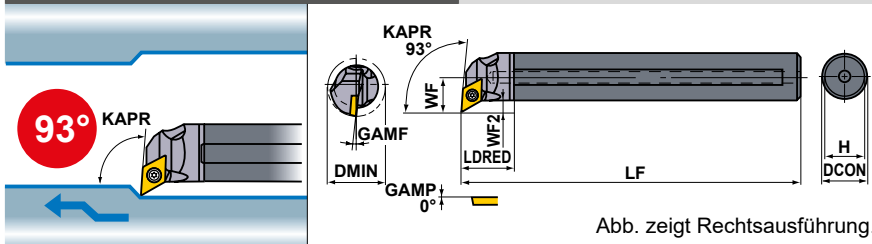

Schichten	Schichten	Leicht	Leicht
FP (07,11)	FM (07,11)	LP (07,11)	LM (07,11)
Mittel	Mittel	PKD	PCBN
MP (07,11)	MM (07,11)	R/L-F (07,11)	(07,11)

Bestellbezeichnung	Lager	Lager		WSP Bezeichnung	Abmessungen (mm)							Max. Empf. l/d Verh.	* Spannschraube	Schlüssel		
		R	L		DCON	LF	LDRED	WF	WF2	H	GAMF				DMIN	
FSDUC1410R/L-07E	●	★	★	DCMT DCMW DCGT DCGW	0702 $\odot$	10	160	16.0	8.3	3.3	9	7.5°	14	7.5	TS25	TKY08F
FSDUC1612R/L-07E	●	★	★		0702 $\odot$	12	180	17.8	9.3	3.3	11	6.0°	16	8	TS25	TKY08F
FSDUC2016R/L-07E	●	★	★		0702 $\odot$	16	220	21.8	11.3	3.3	15	5.0°	20	8	TS25	TKY08F
FSDUC3220R/L-11E ☆	●	★	★		11T3 $\odot$	20	250	24.0	16.1	6.1	19	5.0°	32	8	TS43	TKY15F

\* Spannmoment (N · m) : TS25=1.0, TS43=3.5

Hinweis 1) Die Fotos der Wendeschneidplatten dienen lediglich als Beispiel. Die Buchstaben beziehen sich auf den Spanbrecher und die Abmessungen auf den Innenkreisdurchmesser.

Hinweis 2) Die angegebenen Maße gelten für Wendeschneidplatten mit Eckenradius RE 0.4. (Artikel von ☆ Beschriftet mit RE 0.8)

Hinweis 3) Bei der Verwendung von Wendeschneidplatten mit rechtsseitigem und linksseitigem Spanbrecher verwenden Sie bitte den linksseitigen Spanbrecher für den rechten Halter und den rechtsseitigen Spanbrecher für den linken Halter.

● : Lagerstandard. ★ : Lagerstandard in Japan.

DC $\odot$  WSP > A147 – A152  
PCBN & PKD WSP > B054, B055, B068

FSDQC		Mit Kühlmittelbohrung DC $\odot$ WSP										Schichten		Schichten		Leicht		Leicht	
												FP	FM	LP	LM				
												 (07,11)		 (07,11)		 (07,11)		 (07,11)	
		Mittel		Mittel		PKD		PCBN											
												 (07,11)		 (07,11)		 (07,11)		 (07,11)	
		Mittel		Mittel		R/L-F		PCBN											
Abb. zeigt Rechtsausführung.																			
Bestellbezeichnung	Lager		WSP Bezeichnung	Abmessungen (mm)								Max. Empf. l/d Verh.	*						
	R	L		DCON	LF	LDRED	WF	WF2	H	GAMP	DMIN		Spannschraube	Schlüssel					
FSDQC1310R/L-07A	●	●	DCMT DCMW DCGT DCGW	0702 $\odot$	10	150	20.5	7.6	2.6	9	8°	13	3.5	TS25	TKY08F				
FSDQC1612R/L-07A	●	●		0702 $\odot$	12	150	22.5	8.6	2.6	11	6°	16	4	TS25	TKY08F				
FSDQC2016R/L-07A	●	●		0702 $\odot$	16	180	22.5	10.6	2.6	15	5°	20	5	TS25	TKY08F				
FSDQC2520R/L-11A <sup>☆</sup>	●	●		11T3 $\odot$	20	180	26	13.7	3.7	19	7°	25	5	TS43	TKY15F				

\* Spannmoment (N · m) : TS25=1.0, TS43=3.5

FSDQC_E		HM-Schaft mit Kühlmittelbohrung DC $\odot$ WSP										Schichten		Schichten		Leicht		Leicht	
												FP	FM	LP	LM				
												 (07,11)		 (07,11)		 (07,11)		 (07,11)	
		Mittel		Mittel		PKD		PCBN											
												 (07,11)		 (07,11)		 (07,11)		 (07,11)	
		Mittel		Mittel		R/L-F		PCBN											
Abb. zeigt Rechtsausführung.																			
Bestellbezeichnung	Lager		WSP Bezeichnung	Abmessungen (mm)								Max. Empf. l/d Verh.	*						
	R	L		DCON	LF	LDRED	WF	WF2	H	GAMP	DMIN		Spannschraube	Schlüssel					
FSDQC1310R/L-07E	●	●	DCMT DCMW DCGT DCGW	0702 $\odot$	10	162	18.4	7.6	2.6	9	8°	13	7.5	TS25	TKY08F				
FSDQC1612R/L-07E	●	●		0702 $\odot$	12	182	20.2	8.6	2.6	11	6°	16	8	TS25	TKY08F				
FSDQC2016R/L-07E	●	●		0702 $\odot$	16	222	24.2	10.6	2.6	15	5°	20	8	TS25	TKY08F				
FSDQC2520R/L-11E <sup>☆</sup>	●	●		11T3 $\odot$	20	254	28.0	13.7	3.7	19	7°	25	8	TS43	TKY15F				

\* Spannmoment (N · m) : TS25=1.0, TS43=3.5

E

BOHRSTANGEN

DC $\odot$ WSP > A147–A152  
PCBN & PKD WSP > B054, B055, B068

SCHNITTBEDINGUNGEN > E014  
ERSATZTEILE > N001  
TECHNISCHE DATEN > P001

E011

# BOHRSTANGEN

## DIMPLE BAR

- Ausgezeichneter Vibrationswiderstand durch den leichten Dimple-Kopf.
- Bessere Spankontrolle/-abfuhr durch einen zusätzlichen Spankanal.
- Laser gedruckte Auskragskalierung am Schaft (Stahlschaft).
- l/d ist 3 bis 5x Durchmesser (Hartmetallschaft ist 3-8x Durchmesser).

### FSWUB/P

Mit Kühlmittelbohrung

### WB<sup>○</sup>WSP, WP<sup>○</sup>WSP

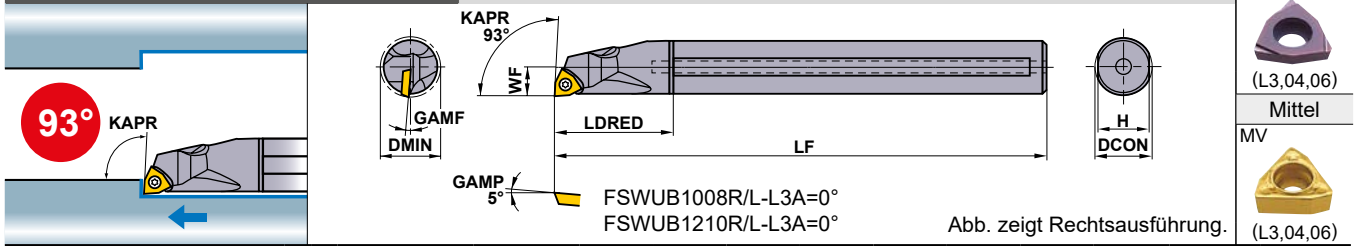

Schichten  
R/L-F-FS



FSWUB1008R/L-L3A=0°  
FSWUB1210R/L-L3A=0°

Abb. zeigt Rechtsausführung.

(L3,04,06)

Bestellbezeichnung	Lager		WSP Bezeichnung	Abmessungen (mm)							Max. Empf. l/d Verh.	*  		
	R	L		DCON	LF	LDRED	WF	H	GAMF	DMIN		Spannschraube	Schlüssel	
FSWUB1008R/L-L3A <sup>☆1</sup>	●	●	WBMT WBGT	L302 <sup>○</sup>	8	125	18	5	7.2	14°	10	3	TS2	TKY06F
FSWUB1210R/L-L3A <sup>☆1</sup>	●	●		L302 <sup>○</sup>	10	150	22.5	6	9	11°	12	3.5	TS2	TKY06F
FSWUP1412R/L-04A	●	●	WPMT WPGT	0402 <sup>○</sup>	12	150	27	7	11	4°	14	4	TS253	TKY08F
FSWUP1816R/L-04A	●	●		0402 <sup>○</sup>	16	180	36	9	15	1°	18	5	TS253	TKY08F
FSWUP2220R/L-06A <sup>☆2</sup>	●	●		0603 <sup>○</sup>	20	220	45	11	19	2°	22	5	TS4	TKY15F
FSWUP3025R/L-06A <sup>☆2</sup>	●	●		0603 <sup>○</sup>	25	250	56.3	15	23.4	0°	30	5	TS4	TKY15F

\* Spannmoment (N • m) : TS2=0.6, TS253=1.0, TS4=3.5

### FSWUB/P\_E

HM-Schaft  
mit Kühlmittelbohrung

### WB<sup>○</sup>WSP, WP<sup>○</sup>WSP

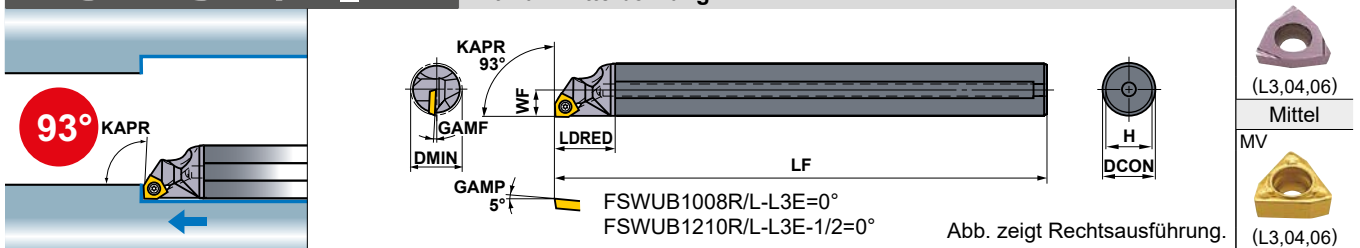

Schichten  
R/L-F-FS



FSWUB1008R/L-L3E=0°  
FSWUB1210R/L-L3E-1/2=0°

Abb. zeigt Rechtsausführung.

(L3,04,06)

Bestellbezeichnung	Lager		WSP Bezeichnung	Abmessungen (mm)							Max. Empf. l/d Verh.	*  		
	R	L		DCON	LF	LDRED	WF	H	GAMF	DMIN		Spannschraube	Schlüssel	
FSWUB1008R/L-L3E <sup>☆1</sup>	★	★	WBMT WBGT	L302 <sup>○</sup>	8	140	13.8	5	7.2	14°	10	7	TS2	TKY06F
FSWUB1008R-L3E-2/3 <sup>☆1</sup>	★			L302 <sup>○</sup>	8	90	13.8	5	7.2	14°	10	5	TS2	TKY06F
FSWUB1008R-L3E-1/2 <sup>☆1</sup>	★			L302 <sup>○</sup>	8	70	13.8	5	7.2	14°	10	3	TS2	TKY06F
FSWUB1210R/L-L3E <sup>☆1</sup>	★	★		L302 <sup>○</sup>	10	160	16.0	6	9	11°	12	7.5	TS2	TKY06F
FSWUB1210R-L3E-2/3 <sup>☆1</sup>	★			L302 <sup>○</sup>	10	105	16.0	6	9	11°	12	5	TS2	TKY06F
FSWUB1210R-L3E-1/2 <sup>☆1</sup>	★			L302 <sup>○</sup>	10	80	16.0	6	9	11°	12	3	TS2	TKY06F
FSWUP1412R/L-04E	★	★	WPMT WPGT	0402 <sup>○</sup>	12	180	17.8	7	11	4°	14	8	TS253	TKY08F
FSWUP1412R-04E-2/3	★			0402 <sup>○</sup>	12	120	17.8	7	11	4°	14	5	TS253	TKY08F
FSWUP1412R-04E-1/2	★			0402 <sup>○</sup>	12	90	17.8	7	11	4°	14	3	TS253	TKY08F
FSWUP1816R/L-04E	★	★		0402 <sup>○</sup>	16	220	21.8	9	15	1°	18	8	TS253	TKY08F
FSWUP1816R-04E-2/3	★			0402 <sup>○</sup>	16	145	21.8	9	15	1°	18	5	TS253	TKY08F
FSWUP1816R-04E-1/2	★			0402 <sup>○</sup>	16	110	21.8	9	15	1°	18	3	TS253	TKY08F
FSWUP2220R/L-06E <sup>☆2</sup>	★	★		0603 <sup>○</sup>	20	250	24.0	11	19	2°	22	8	TS4	TKY15F
FSWUP 2220R-06E-2/3 <sup>☆2</sup>	★			0603 <sup>○</sup>	20	165	24.0	11	19	2°	22	5	TS4	TKY15F
FSWUP 2220R-06E-1/2	★			0603 <sup>○</sup>	20	125	24.0	11	19	2°	22	3	TS4	TKY15F

\* Spannmoment (N • m) : TS2=0.6, TS253=1.0, TS4=3.5

Hinweis 1) Die Fotos der Wendeschneidplatten dienen lediglich als Beispiel. Die Buchstaben beziehen sich auf den Spanbrecher und die Abmessungen auf den Innenkreisdurchmesser.

Hinweis 2) Die angegebenen Maße gelten für Wendeschneidplatten mit Eckenradius RE 0.4. (Artikel von ☆1 beschriftet mit RE 0.2, Artikel von ☆2 beschriftet mit RE 0.8)

Hinweis 3) Bei der Verwendung von Wendeschneidplatten mit rechtsseitigem und linksseitigem Spanbrecher verwenden Sie bitte den

linksseitigen Spanbrecher für den rechten Halter und den rechtsseitigen Spanbrecher für den linken Halter.

● : Lagerstandard. ★ : Lagerstandard in Japan.

WB<sup>○</sup>WSP > A172  
WP<sup>○</sup>WSP > A174  
PKD WSP > B072



# FSVUB/C

## VC<sup>0</sup>WSP, VB<sup>0</sup>WSP

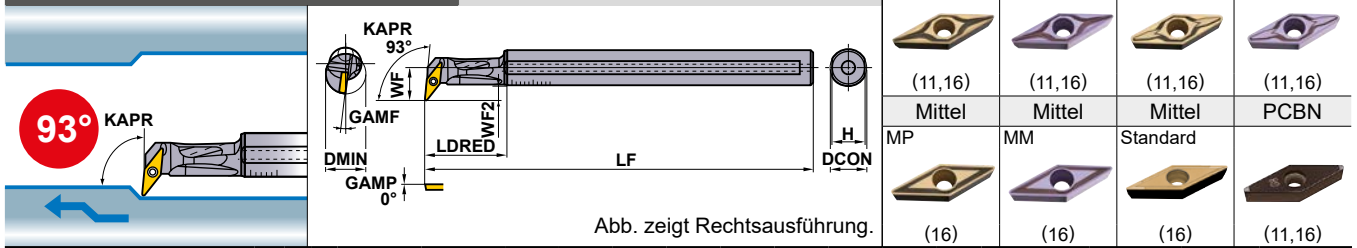

Bestellbezeichnung	Kühlmittelbohrung	Lager		WSP Bezeichnung	Abmessungen (mm)							Max. Empf. /d. Verh.	Unterlegplatte	Befestigungsfeder	Spannschraube*	Schlüssel		
		R	L		DCON	LF	LDRED	WF	WF2	H	GAMF						DMIN	
FSVUC1612R/L-08A	○	●	●	VC <sup>0</sup> GT VC <sup>0</sup> MT	0802	12	150	25	11	5.5	11	8°	16	4	—	—	TS202	TKY06F
FSVUB2016R/L-11A	○	●	●		1103	16	180	32.5	15.5	8	15	8°	20	5	—	—	TS255	TKY08F
FSVUB2520R/L-11A	○	●	●	VB <sup>0</sup> MT VB <sup>0</sup> MW	1103	20	200	40.5	17.5	8	19	7°	25	5	—	—	TS255	TKY08F
FSVUB2520R-11S	—	★		VB <sup>0</sup> ET	1103	20	200	40.5	17.5	8	19	7°	25	5	—	—	TS255	TKY08F
FSVUB3425R/L-16A <sup>☆2</sup>	○	●	●	VB <sup>0</sup> GW	1604	25	220	50	20.5	8.5	23.4	13°	34	5	SPSVN32	BCP141	TS35D	TKY15F
FSVUB4032R/L-16A <sup>☆2</sup>	○	●	●		1604	32	250	84.0	27.5	12	30.4	9°	40	5	SPSVN32	BCP141	TS35D	TKY15F

\* Spannmoment (N • m) : TS202=0.6, TS255=1.0, TS35D=3.5

# FSVVPB/C

## VC<sup>0</sup>WSP, VB<sup>0</sup>WSP

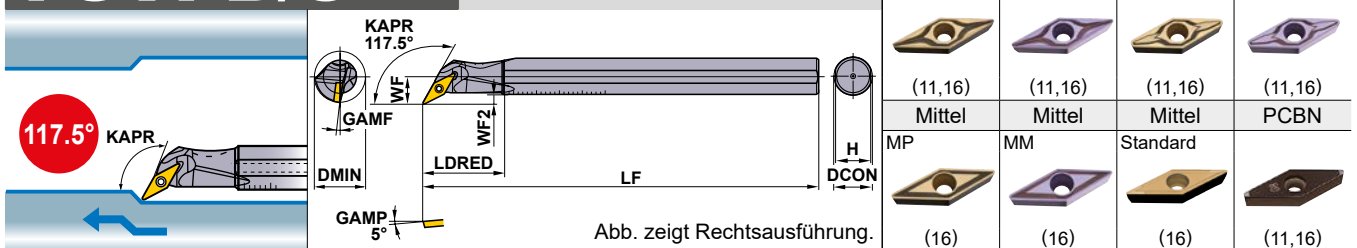

Bestellbezeichnung	Kühlmittelbohrung	Lager		WSP Bezeichnung	Abmessungen (mm)							Max. Empf. /d. Verh.	Unterlegplatte	Befestigungsfeder	Spannschraube*	Schlüssel		
		R	L		DCON	LF	LDRED	WF	WF2	H	GAMF						DMIN	
FSVPC1610R/L-08A	○	●	●	VC <sup>0</sup> GT VC <sup>0</sup> MT	0802	10	150	25	8	3	9	8°	16	3.5	—	—	TS202	TKY06F
FSVVPB2012R/L-11A	○	●	●		1103	12	150	28	10	4.5	11	8°	20	4	—	—	TS255	TKY08F
FSVVPB2516R/L-11A	○	●	●	VB <sup>0</sup> MT VB <sup>0</sup> MW	1103	16	180	35	12.5	5	15	5°	25	5	—	—	TS255	TKY08F
<b>NEW</b> FSVVPB3020R-11S	—	★		VB <sup>0</sup> ET	1103	20	200	40	15	5	19	5°	30	5	—	—	TS255	TKY08F
FSVVPB3425R/L-16A <sup>☆2</sup>	○	●	●	VB <sup>0</sup> GW	1604	25	220	50	17	5	23.4	13°	34	5	SPSVN32	BCP141	TS35D	TKY15F
FSVVPB4032R/L-16A <sup>☆2</sup>	○	●	●		1604	32	250	55	22	6.5	30.4	9°	40	5	SPSVN32	BCP141	TS35D	TKY15F

\* Spannmoment (N • m) : TS202=0.6, TS255=1.0, TS35D=3.5

VB <sup>0</sup> WSP	> A164 – A166
VC <sup>0</sup> WSP	> A167 – A169
PCBN & PKD WSP	> B059, B071

SCHNITTBEDINGUNGEN	> E014
ERSATZTEILE	> N001
TECHNISCHE DATEN	> P001

# DIMPLE BAR

- Ausgezeichneter Vibrationswiderstand durch den leichten Dimple-Kopf.
- Bessere Spankontrolle/-abfuhr durch einen zusätzlichen Spankanal.
- Laser gedruckte Auskragskalierung am Schaft (Stahlschaft).
- l/d ist 3 bis 5x Durchmesser.

## FSVJB/C

### VC<sup>○</sup>WSP, VB<sup>○</sup>WSP



Abb. zeigt Rechtsausführung.

Schichten	Schichten	Leicht	Leicht
FP	FM	LP	LM
(11)	(11)	(11)	(11)
Mittel			
MV			
(08,11)			

Bestellbezeichnung	Lager		WSP Bezeichnung	Abmessungen (mm)							Max. Empf. l/d Verh.	*	
	R	L		DCON	LF	LDRED	WF	H	GAMP	DMIN		Spannschraube	Schlüssel
FSVJC1612R/L-08S ☆	●	●	VCGT 0802 <sup>○</sup>	12	150	26	2	11	5°	16	4	TS202	TKY06F
FSVJC2016R/L-08S ☆	●	●	VCMT 0802 <sup>○</sup>	16	180	36	2	15	5°	20	5	TS202	TKY06F
FSVJB2520R/L-11S ☆	●	●	VBMT VBMW VBET VBGW 1103 <sup>○</sup>	20	200	37.5	2	19	5°	25	5	TS255	TKY08F
FSVJB3025R/L-11S ☆	●	●	1103 <sup>○</sup>	25	250	45	3.5	23.4	5°	30	5	TS255	TKY08F

\* Spannmoment (N • m) : TS202=0.6, TS255=1.0

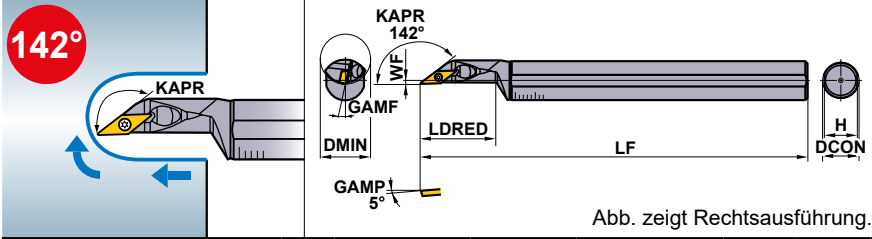
E

BOHRSTANGEN

## SCHNITTDATENEMPFEHLUNGEN

Material	Eigenschaften	Schnittmodus	Spanbrecher	Empfehlung	Schnittgeschw. (m/min)	L/D ≤ 3 (Stahlschaft)		L/D ≤ 4-5 (Stahlschaft)					
						Vorschub (mm/U.)	Schnitttiefe (mm)	Vorschub (mm/U.)	Schnitttiefe (mm)				
P Allg. Baustahl	≤180HB	Schichten	FP	FV	NX2525	170 (120-220)	0.10 (0.05-0.15)	-0.5	0.10 (0.05-0.15)	-0.5			
			LP	SV	MP3025	150 (100-200)	0.20 (0.10-0.25)	-1.0	0.15 (0.05-0.20)	-1.0			
			LP	SV	NX2525	160 (110-210)	0.20 (0.10-0.25)	-1.0	0.15 (0.05-0.20)	-1.0			
		Leicht	SV	-	NX3035	150 (100-200)	0.20 (0.10-0.25)	-1.0	0.15 (0.05-0.20)	-1.0			
			MP	MV	MP3025	140 (90-190)	0.25 (0.15-0.35)	-2.0	0.20 (0.15-0.25)	-1.5			
			MP	MV	NX2525	150 (100-200)	0.25 (0.15-0.35)	-2.0	0.20 (0.15-0.25)	-1.5			
	Mittel	MV	-	NX3035	140 (90-190)	0.25 (0.15-0.35)	-2.0	0.20 (0.15-0.25)	-1.5				
		180-350HB	Schichten	FP	-	MC6115	140 (90-190)	0.10 (0.05-0.15)	-0.5	0.10 (0.05-0.15)	-0.5		
				FV	-	VP15TF	140 (90-190)	0.10 (0.05-0.15)	-0.5	0.10 (0.05-0.15)	-0.5		
	FP			FV	NX2525	130 (80-180)	0.10 (0.05-0.15)	-0.5	0.10 (0.05-0.15)	-0.5			
	Leicht		LP	SV	MC6125	140 (90-190)	0.20 (0.10-0.25)	-1.0	0.15 (0.05-0.20)	-1.0			
			LP	SV	MP3025	110 (60-160)	0.20 (0.10-0.25)	-1.0	0.15 (0.05-0.20)	-1.0			
SV			-	NX3035	110 (60-160)	0.20 (0.10-0.25)	-1.0	0.15 (0.05-0.20)	-1.0				
Mittel	MP	MV	MC6125	130 (80-180)	0.25 (0.15-0.35)	-2.0	0.20 (0.15-0.25)	-1.5					
	MP	MV	MP3025	100 (60-150)	0.25 (0.15-0.35)	-2.0	0.20 (0.15-0.25)	-1.5					
	MV	-	NX3035	100 (60-150)	0.25 (0.15-0.35)	-2.0	0.20 (0.15-0.25)	-1.5					
M Rostfreier Stahl	≤200HB	Schichten	FM	FV	VP15TF	150 (110-190)	0.10 (0.05-0.15)	-0.5	0.10 (0.05-0.15)	-0.5			
			LM	-	MC7025	125 (85-165)	0.20 (0.10-0.25)	-1.0	0.15 (0.05-0.20)	-1.0			
			SV	-	US735	125 (85-165)	0.20 (0.10-0.25)	-1.0	0.15 (0.05-0.20)	-1.0			
		Leicht	LM	SV	VP15TF	130 (90-170)	0.20 (0.10-0.25)	-1.0	0.15 (0.05-0.20)	-1.0			
			MM	-	MC7025	105 (70-135)	0.20 (0.10-0.25)	-2.0	0.20 (0.15-0.25)	-1.0			
			MV	-	US735	125 (85-165)	0.20 (0.10-0.25)	-1.0	0.15 (0.05-0.20)	-1.0			
		Mittel	MM	MV	VP15TF	120 (80-160)	0.20 (0.10-0.25)	-2.0	0.20 (0.15-0.25)	-1.0			
			K Grauguss	Zugfestigkeit ≤350MPa	Schichten	F	FS	HTi10	130 (90-160)	0.15 (0.10-0.20)	-0.5	0.15 (0.05-0.20)	-0.5
						MK	-	MC5015	90 (60-120)	0.20 (0.15-0.25)	-2.0	0.20 (0.15-0.25)	-1.5
Mittel	MV	-			VP15TF	90 (60-120)	0.20 (0.10-0.25)	-2.0	0.20 (0.15-0.25)	-1.5			
N Aluminiumlegierung	-	Schichten	F	FS	HTi10	300 (200-400)	0.10 (0.05-0.15)	-0.5	0.10 (0.05-0.15)	-0.5			
			Glatt	-	MD220	200 (150-250)	0.10 (0.05-0.15)	-2.0	0.10 (0.05-0.15)	-1.0			
H Gehärteter Stahl	35-65HRC	Schichten	Glatt	-	MB8120	100 (80-200)	0.10 (0.05-0.15)	-0.15	0.10 (0.05-0.15)	-0.1			

Hinweis 1) Bei Vibrationen reduzieren Sie bitte die Schnittgeschwindigkeit.

Hinweis 2) Bei der Verwendung des Typs FSVJ, muss die Schnitttiefe geringer sein als der WSP Eckenradius.

Hinweis 3) Der empfohlene Druck für das innere Kühlmittel beträgt 10 Bar.

Hinweis 4) Die Fotos der Wendeschneidplatte dienen lediglich als Beispiel. Die Buchstaben beziehen sich auf den Spanbrecher und die Abmessungen auf den Innenkreisdurchmesser.

Hinweis 5) Die angegebenen Maße gelten für Wendeschneidplatten mit Eckenradius RE 0.4. (Artikel von ☆ beschriftet mit RE 0.8)

Hinweis 6) Bei der Verwendung von Wendeschneidplatten mit rechtsseitigem und linksseitigem Spanbrecher verwenden Sie bitte den linksseitigen Spanbrecher für den rechten Halter und den rechtsseitigen Spanbrecher für den linken Halter.

● : Lagerstandard. ★ : Lagerstandard in Japan.

VB <sup>○</sup> WSP	> A164-A166
VC <sup>○</sup> WSP	> A167-A169
PCBN & PKD WSP	> B059, B071

# DOPPEL KLEMM

# DIMPLE BAR

- Wirtschaftliche neagtive WSP.
- Einschritttyp.
- Ausgezeichneter Vibrationswiderstand durch den leichten Dimple-Kopf (mit Kühlmittelbohrung).
- l/d ist 3 bis 4x Durchmesser.

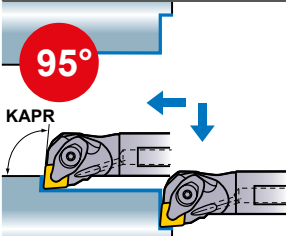
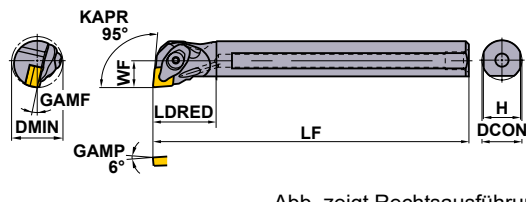
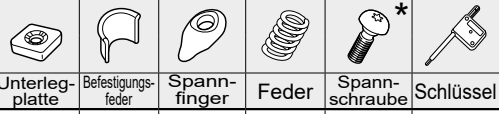
A○○○-DCLN		Mit Kühlmittelbohrung		CN○○WSP		Schichten	Leicht	Leicht	Mittel								
				Abb. zeigt Rechtsausführung.		FP (12)	SA (12)	LP (12)	LM (12)								
						Mittel	Mittel	Rostfrei	PCBN/PKD								
						MP (12)	Standard (12)	MM (12)	(12)								
Bestellbezeichnung	Lager		WSP Bezeichnung	Abmessungen (mm)													
	R	L		DCON	LF	LDRED	WF	H	GAMF	DMIN	Unterlegplatte	Befestigungsfeder	Spannring	Feder	Spannschraube	Schlüssel	
A25R-DCLNR/L12	●	●	CN○A	1204○○	25	200	40	17	23	13°	32	LLSCP42	LLP14	DCK2613	DCS1	DC0621T	TKY20F
A32S-DCLNR/L12	●	●	CN○G	1204○○	32	250	50	22	30	13°	40	LLSCN42	LLP14	DCK2613	DCS1	DC0621T	TKY20F
A40T-DCLNR/L12	●	●	CN○M	1204○○	40	300	63	27	37	10°	50	LLSCN42	LLP14	DCK2613	DCS1	DC0621T	TKY20F

\* Spannmoment (N • m) : DC0621T=5.0

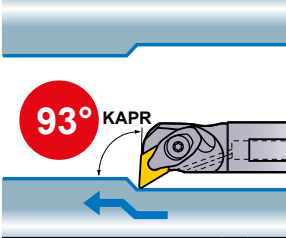
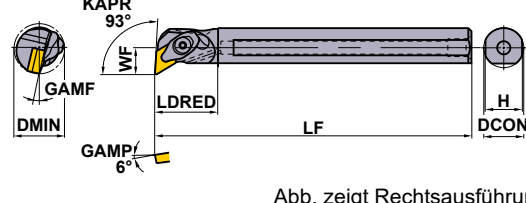
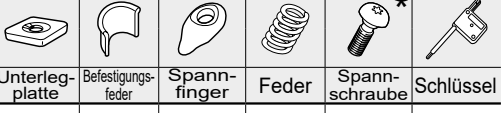
A○○○-DDUN		Mit Kühlmittelbohrung		DN○○WSP		Schichten	Leicht	Mittel	Mittel								
				Abb. zeigt Rechtsausführung.		FP (15)	LP (15)	MP (15)	MH (15)								
						Mittel	Rostfrei	G-Klasse	PCBN/PKD								
						Standard (15)	MM (15)	R/L (15)	(15)								
Bestellbezeichnung	Lager		WSP Bezeichnung	Abmessungen (mm)													
	R	L		DCON	LF	LDRED	WF	H	GAMF	DMIN	Unterlegplatte	Befestigungsfeder	Spannring	Feder	Spannschraube	Schlüssel	
A25R-DDUNR/L15	●	★	DN○A	1504○○	25	200	40	17	23	13°	35	LLSDP42	LLP14	DCK2613	DCS1	DC0621T	TKY20F
A32S-DDUNR/L15	●	●	DN○G	1504○○	32	250	50	22	30	13°	40	LLSDN42	LLP14	DCK2613	DCS1	DC0621T	TKY20F
A40T-DDUNR/L15	●	●	DN○M	1504○○	40	300	63	27	37	10°	50	LLSDN42	LLP14	DCK2613	DCS1	DC0621T	TKY20F

\* Spannmoment (N • m) : DC0621T=5.0

BOHRSTANGEN

## SCHNITTDATENEMPFEHLUNGEN

Material	Härte	Schnittmodus	l/d ≤ 3			l/d = 3–4		
			Schnittgeschw. (m/min)	Vorschub (mm/U.)	Schnitttiefe (mm)	Schnittgeschw. (m/min)	Vorschub (mm/U.)	Schnitttiefe (mm)
P C-Stahl, Leg. Stahl	180–350HB	Mittel	110 (80–140)	0.25 (0.1–0.4)	–5.0	110 (80–140)	0.2 (0.1–0.3)	–4.0
M Rostfreier Stahl	≤200HB	Mittel	80 (60–100)	0.2 (0.1–0.3)	–4.0	70 (50–100)	0.15 (0.1–0.25)	–3.0
K Grauguss	Zugfestigkeit ≤350MPa	Mittel	80 (60–100)	0.25 (0.1–0.4)	–5.0	80 (60–100)	0.2 (0.1–0.3)	–4.0

CN○○ WSP > A098–A104  
 DN○○ WSP > A105–A111  
 PCBN & PKD WSP > B036–B042, B064

ERSATZTEILE > N001  
 TECHNISCHE DATEN > P001







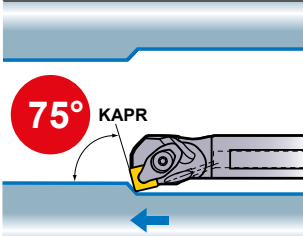
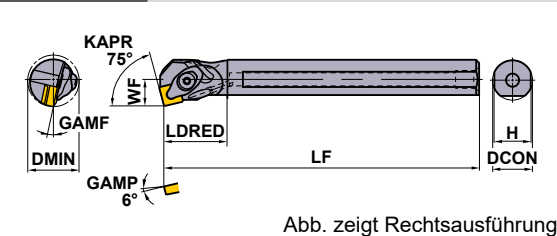

# BOHRSTANGEN

## DOPPEL KLEMM







# DIMPLE BAR

- Wirtschaftliche neagtive WSP.
- Einschnitttyp.
- Ausgezeichneter Vibrationswiderstand durch den leichten Dimple-Kopf (mit Kühlmittelbohrung).
- l/d ist 3 bis 4x Durchmesser.

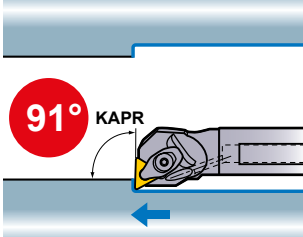
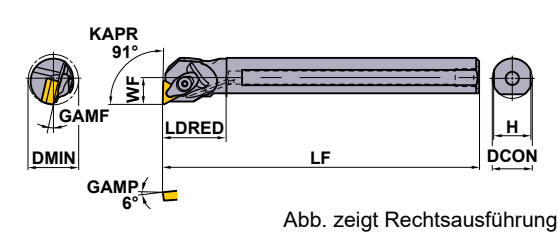
A○○○-DSKN		Mit Kühlmittelbohrung		SN○○WSP		Schichten	Leicht	Mittel	Mittel								
				Abb. zeigt Rechtsausführung.		FP (12)	LP (12)	MP (12)	MH (12)								
						Mittel	Rostfrei	G-Klasse	PCBN/PKD								
						Standard (12)	MM (12)	R/L (12)	(12)								
Bestellbezeichnung	Lager		WSP Bezeichnung	Abmessungen (mm)													
	R	L		DCON	LF	LDRED	WF	H	GAMF	DMIN	Unterlegplatte	Befestigungsfeder	Spannfinger	Feder	Spannschraube	Schlüssel	
A25R-DSKNR/L12	★	★	SNMA SONMG SONMM SONGA SONGG	1204○○	25	200	40	17	23	13°	32	LLSSP42	LLP14	DCK2613	DCS1	DC0621T	TKY20F
A32S-DSKNR/L12	★	★		1204○○	32	250	50	22	30	13°	40	LLSSN42	LLP14	DCK2613	DCS1	DC0621T	TKY20F

\* Spannmoment (N • m) : DC0621T=5.0

BOHRSTANGEN

A○○○-DTFN		Mit Kühlmittelbohrung		TN○○WSP		Schichten	Leicht	Mittel	Mittel								
				Abb. zeigt Rechtsausführung.		FP (16)	LP (16)	MP (16)	MH (16)								
						Mittel	Rostfrei	G-Klasse	PCBN/PKD								
						Standard (16)	MM (16)	R/L (16)	(16)								
Bestellbezeichnung	Lager		WSP Bezeichnung	Abmessungen (mm)													
	R	L		DCON	LF	LDRED	WF	H	GAMF	DMIN	Unterlegplatte	Befestigungsfeder	Spannfinger	Feder	Spannschraube	Schlüssel	
A25R-DTFNR/L16	●	●	TN○○A TN○○G TN○○M	1604○○	25	200	40	17	23	13°	32	LLSTP32	LLP23	DCK2211	DCS2	DC0520T	TKY15F
A32S-DTFNR/L16	★	★		1604○○	32	250	50	22	30	13°	40	LLSTN32	LLP23	DCK2211	DCS2	DC0520T	TKY15F

\* Spannmoment (N • m) : DC0520T=3.5

Hinweis 1) Die Fotos der Wendschneidplatten dienen lediglich als Beispiel. Die Buchstaben beziehen sich auf den Spanbrecher und die Abmessungen auf den Innenkreisdurchmesser.

Hinweis 2) Die angegebenen Maße gelten für Wendschneidplatten mit Eckenradius RE 0.8.

Hinweis 3) Bei der Verwendung von Wendschneidplatten mit rechtsseitigem und linksseitigem Spanbrecher verwenden Sie bitte den linksseitigen Spanbrecher für den rechten Halter und den rechtsseitigen Spanbrecher für den linken Halter.

● : Lagerstandard. ★ : Lagerstandard in Japan.

SN○○WSP	> A113–A118
TN○○WSP	> A119–A125
PCBN & PKD WSP	> B043–B045, B065

A $\circ\circ\circ$ -DVUN		Mit Kühlmittelbohrung		VN $\circ\circ$ WSP		Schichten	Leicht	Mittel	Mittel							
				FP	LP	MP	MH									
				(16)	(16)	(16)	(16)									
				Mittel	Rostfrei	G-Klasse	PCBN/PKD									
				Standard	MM	R/L										
				(16)	(16)	(16)	(16)									
				Abb. zeigt Rechtsausführung.												
Bestellbezeichnung	Lager	WSP Bezeichnung	Abmessungen (mm)													
	R		L	DCON	LF	LDRED	WF	H	GAMF							DMIN
<b>A40T-DVUNR/L16</b>	● ★	VN $\circ$ A VN $\circ$ G VN $\circ$ M	1604 $\circ\circ$	40	300	63	27	37	9°	50	DCSVN32	LLP13	DCK3113	DCS2	DC0520T	TKY15F

\* Spannmoment (N • m) : DC0520T=3.5

A $\circ\circ\circ$ -DWLN		Mit Kühlmittelbohrung		WN $\circ\circ$ WSP		Schichten	Leicht	Mittel	Mittel							
				FP	LP	MP	MK									
				(08)	(06,08)	(06,08)	(08)									
				Mittel	Mittel-Schruppen	Rostfrei										
				Standard	RP	MM										
				(08)	(08)	(06,08)										
				Abb. zeigt Rechtsausführung.												
Bestellbezeichnung	Lager	WSP Bezeichnung	Abmessungen (mm)													
	R		L	DCON	LF	LDRED	WF	H	GAMF							DMIN
<b>A25R-DWLNLR/L06</b>	● ★	WNMA WNMG	0604 $\circ\circ$	25	200	40	17	23	13°	35	LLSWP32	LLP23	DCK2211	DCS2	DC0520T	TKY15F
<b>A25R-DWLNLR/L08</b>	● ●	WNMA	0804 $\circ\circ$	25	200	40	17	23	13°	35	LLSWP42	LLP14	DCK2613	DCS1	DC0621T	TKY20F
<b>A32S-DWLNLR/L08</b>	● ●	WNMA WNMG	0804 $\circ\circ$	32	250	50	22	30	13°	40	LLSWN42	LLP14	DCK2613	DCS1	DC0621T	TKY20F
<b>A40T-DWLNLR/L08</b>	● ●	WNGA	0804 $\circ\circ$	40	300	63	27	37	10°	50	LLSWN42	LLP14	DCK2613	DCS1	DC0621T	TKY20F

\* Spannmoment (N • m) : DC0520T=3.5, DC0621T=5.0

E

BOHRSTANGEN

## SCHNITTDATENEMPFEHLUNGEN

Material	Härte	Schnittmodus	l/d ≤ 3			l/d = 3–4		
			Schnittgeschw. (m/min)	Vorschub (mm/U.)	Schnitttiefe (mm)	Schnittgeschw. (m/min)	Vorschub (mm/U.)	Schnitttiefe (mm)
<b>P</b> C-Stahl, Leg. Stahl	180–350HB	Mittel	110 (80–140)	0.25 (0.1–0.4)	–5.0	110 (80–140)	0.2 (0.1–0.3)	–4.0
<b>M</b> Rostfreier Stahl	≤200HB	Mittel	80 (60–100)	0.2 (0.1–0.3)	–4.0	70 (50–100)	0.15 (0.1–0.25)	–3.0
<b>K</b> Grauguss	Zugfestigkeit ≤350MPa	Mittel	80 (60–100)	0.25 (0.1–0.4)	–5.0	80 (60–100)	0.2 (0.1–0.3)	–4.0

VN $\circ\circ$ WSP > A126–A129  
 WN $\circ\circ$ WSP > A130–A134  
 PCBN & PKD WSP > B046–B048, B066

ERSATZTEILE > N001  
 TECHNISCHE DATEN > P001

E017

# BOHRSTANGEN

## MICRO-DEX BOHRSTANGEN

- Der kleinste Bearbeitungsdurchmesser ist  $\phi 5$ .
- $l/d$  ist 5x Durchmesser.
- 5°, 7° positive WSP, VHM-Schaft.
- Einfache Handhabung.
- Geeignet für kleine Werkstücke.

## CC<sup>○</sup>WSP

Hartmetallschaft

## CC<sup>○</sup>WSP

Schichten  
L-F

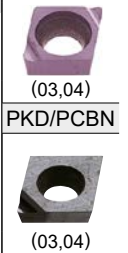
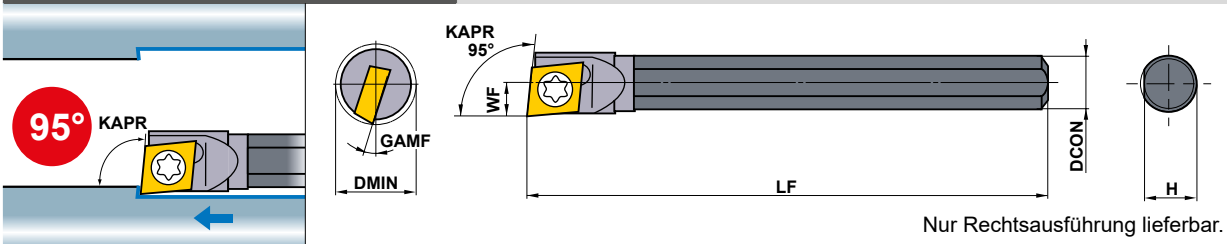

Nur Rechtsausführung lieferbar.

Bestellbezeichnung	Lager R	WSP Bezeichnung	Abmessungen (mm)						*2	Schlüssel	
			DCON	LF	WF	H	GAMF	DMIN			
<b>C04GSCLCR03</b>	●	*1	03S1 <sup>○</sup>	4	90	2.5	3.7	15°	5	TS16	TKY06F
<b>C05HSCLCR03</b>	●	CCGT	03S1 <sup>○</sup>	5	100	3.0	4.7	13°	6	TS16	TKY06F
<b>C06JSCLCR04</b>	●	CCGW	04T0 <sup>○</sup>	6	110	3.5	5.7	13°	7	TS21	TKY08F
<b>C07KSCLCR04</b>	●	CCMW	04T0 <sup>○</sup>	7	125	4.0	6.7	11°	8	TS21	TKY08F

\*1 Der Innenkreis der WSP ist eine Sonderausführung. (Für SCLC typ)

\*2 Spannmoment (N • m) : TS16=0.6, TS21=0.6

E

BOHRSTANGEN

## CC<sup>○</sup>SWUB

Hartmetallschaft

## WB<sup>○</sup>WSP

Schichten  
L-F

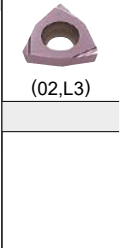
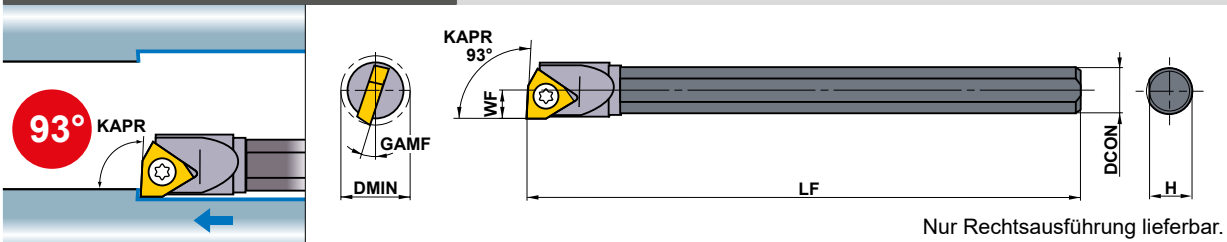

Nur Rechtsausführung lieferbar.

Bestellbezeichnung	Lager R	WSP Bezeichnung	Abmessungen (mm)						*2	Schlüssel	
			DCON	LF	WF	H	GAMF	DMIN			
<b>C05HSWUBR02</b>	●	WBGT	0201 <sup>○</sup> L-F	5	100	3.0	4.7	15°	6	TS21	TKY06F
<b>C06JSWUBR02</b>	●	WBMT	0201 <sup>○</sup> L-F	6	110	3.5	5.7	13°	7	TS2C	TKY06F
<b>C07KSWUBRL3</b>	●		L302 <sup>○</sup> L-F	7	125	4.0	6.7	15°	8	TS2	TKY06F

\* Spannmoment (N • m) : TS21=0.6, TS2C=0.6, TS2=0.6

Hinweis 1) Die Fotos der Wendeschneidplatten dienen lediglich als Beispiel. Die Buchstaben beziehen sich auf den Spanbrecher und die Abmessungen auf den Innenkreisdurchmesser.

Hinweis 2) Die angegebenen Maße gelten für Wendeschneidplatten mit Eckenradius RE 0.2.

Hinweis 3) Bei der Verwendung von Wendeschneidplatten mit rechtsseitigem und linksseitigem Spanbrecher verwenden Sie bitte den linksseitigen Spanbrecher für den rechten Halter und den rechtsseitigen Spanbrecher für den linken Halter.

● : Lagerstandard.

CC <sup>○</sup> WSP	> A140
WB <sup>○</sup> WSP	> A172
PCBN & PKD WSP	> B052, B067

# MICRO-DEX BOHRSTANGEN

## COOSTUC

Hartmetallschaft

TCGT WSP



Schichten

R/L-F

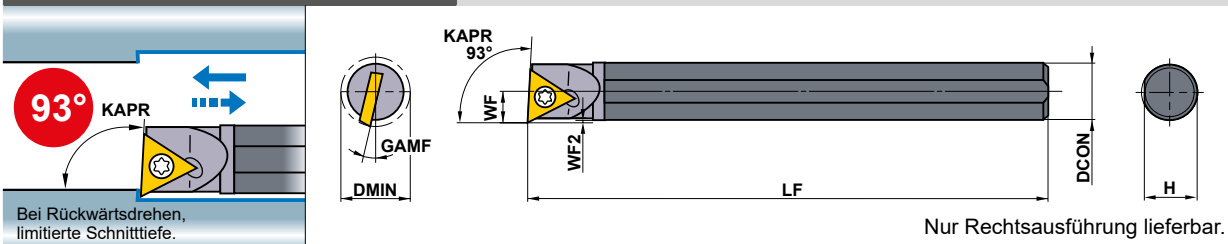

(06)



Bestellbezeichnung	Lager R	WSP Bezeichnung		Abmessungen (mm)							*  	
				DCON	LF	WF	WF2	H	GAMF	DMIN	Spannschraube	Schlüssel
<b>C07KSTUCR06</b>	●	TCGT	0601○○L-F	7	125	4.0	0.35	6.7	12°	<b>8</b>	TS2C	TKY06F

\* Spannmoment (N • m) : TS2C=0.6

E

BOHRSTANGEN

## SCHNITTDATENEMPFEHLUNGEN

	Material	Sorte	Schnittgeschw. (m/min)	Vorschub (mm/U.)	Schnitttiefe (mm)	l/d
P	C-Stahl, Leg. Stahl 180–350HB	<b>NX2525</b>	80 (40–120)	0.03 (0.01–0.05)	0.2 (0.1–0.3)	3–5
M	Rostfreier Stahl ≤200HB	<b>VP15TF</b>	80 (40–120)	0.03 (0.01–0.05)	0.2 (0.1–0.3)	3–5
K	Grauguss ≤350MPa	<b>VP15TF</b>	80 (40–120)	0.03 (0.01–0.05)	0.2 (0.1–0.3)	3–5
N	Aluminiumlegierung	<b>VP15TF</b>	120 (80–160)	0.05 (0.01–0.08)	0.4 (0.1–0.6)	3–5
		<b>MD220</b>	120 (80–160)	0.05 (0.01–0.08)	0.4 (0.1–0.6)	3–5
H	Gehärteter Stahl 35–65HRC	<b>MB8110</b>	80 (40–120)	0.03 (0.01–0.05)	0.1 (0.03–0.2)	3–5

TCGT WSP > A158  
ERSATZTEILE > N001  
TECHNISCHE DATEN > P001

E019

# BOHRSTANGEN

## MICRO-DEX BOHRSTANGEN

### STANDARD HALTER

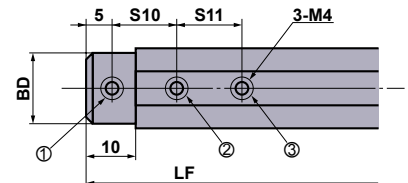
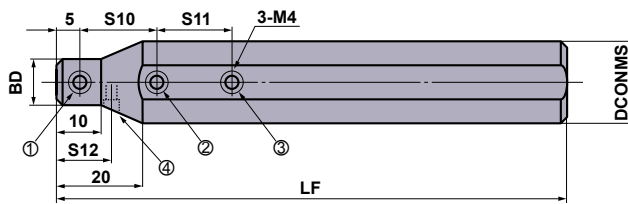

RBH22...N hat eine provisorische Stellschraube für verschiedene Maschinenspezifikationen.  
(Dargestellt durch die Nummer 4)

RBH158...N, RBH16...N,  
RBH190...N

Bestellbezeichnung	Lager	Abmessungen (mm)						MICRO-DEX	*1 Spannschraube				Schlüssel	Drehmoment (N • m)	
		DCONMS	DCONWS	BD	LF	S10	S11		S12	①	②	③			④
RBH15840N	★	15.875	4	15	100	15	15	—	C04GS...R...	A	A	A	—	HKY20F	2.0
RBH15850N	★	15.875	5	15	100	15	15	—	C05HS...R...	A	A	A	—	HKY20F	2.0
RBH15860N	★	15.875	6	15	100	15	15	—	C06JS...R...	A	A	A	—	HKY20F	2.0
RBH15870N	★	15.875	7	15	100	20	20	—	C07KS...R...	A	A	A	—	HKY20F	2.0
RBH1640N	●	16	4	15	100	15	15	—	C04GS...R...	A	A	A	—	HKY20F	2.0
RBH1650N	●	16	5	15	100	15	15	—	C05HS...R...	A	A	A	—	HKY20F	2.0
RBH1660N	●	16	6	15	100	15	15	—	C06JS...R...	A	A	A	—	HKY20F	2.0
RBH1670N	●	16	7	15	100	20	20	—	C07KS...R...	A	A	A	—	HKY20F	2.0
*2 RBH19040N	★	19.05	4	18	125	15	15	—	C04GS...R...	B	B	B	—	HKY20F	2.0
*2 RBH19050N	★	19.05	5	18	125	15	15	—	C05HS...R...	B	B	B	—	HKY20F	2.0
*2 RBH19060N	★	19.05	6	18	125	15	15	—	C06JS...R...	B	B	B	—	HKY20F	2.0
*2 RBH19070N	★	19.05	7	18	125	20	20	—	C07KS...R...	B	B	B	—	HKY20F	2.0
RBH2040N	★	20	4	13	125	15	15	—	C04GS...R...	A	B	B	—	HKY20F	2.0
RBH2050N	★	20	5	14	125	15	15	—	C05HS...R...	A	B	B	—	HKY20F	2.0
RBH2060N	★	20	6	15	125	15	15	—	C06JS...R...	A	B	B	—	HKY20F	2.0
RBH2070N	★	20	7	16	125	20	20	—	C07KS...R...	A	B	B	—	HKY20F	2.0
RBH2240N	★	22	4	13	125	15	15	12.5	C04GS...R...	A	B	B	A	HKY20F	2.0
RBH2250N	★	22	5	14	125	15	15	12.5	C05HS...R...	A	B	B	A	HKY20F	2.0
RBH2260N	★	22	6	15	125	15	15	15	C06JS...R...	A	B	B	A	HKY20F	2.0
RBH2270N	★	22	7	16	125	20	20	15	C07KS...R...	A	B	B	A	HKY20F	2.0
RBH2540N	★	25	4	13	150	15	15	—	C04GS...R...	A	C	C	—	HKY20F	2.0
RBH2550N	★	25	5	14	150	15	15	—	C05HS...R...	A	C	C	—	HKY20F	2.0
RBH2560N	★	25	6	15	150	15	15	—	C06JS...R...	A	C	C	—	HKY20F	2.0
RBH2570N	★	25	7	16	150	20	20	—	C07KS...R...	A	C	C	—	HKY20F	2.0
RBH25440N	★	25.4	4	13	150	15	15	—	C04GS...R...	A	C	C	—	HKY20F	2.0
RBH25450N	★	25.4	5	14	150	15	15	—	C05HS...R...	A	C	C	—	HKY20F	2.0
RBH25460N	★	25.4	6	15	150	15	15	—	C06JS...R...	A	C	C	—	HKY20F	2.0
RBH25470N	★	25.4	7	16	150	20	20	—	C07KS...R...	A	C	C	—	HKY20F	2.0

\*1 Bestellbezeichnung der Spannschrauben: A=HSS04004, B=HSS04006, C=HSS04008

\*2 Neue Bestellbezeichnung.

Alte Bestellbezeichnung	Neue Bestellbezeichnung
RBH1940N	RBH19040N
RBH1950N	RBH19050N
RBH1960N	RBH19060N
RBH1970N	RBH19070N

● : Lagerstandard. ★ : Lagerstandard in Japan.

# MICRO-MINI TWIN

## CB

Für Innenbearbeitung

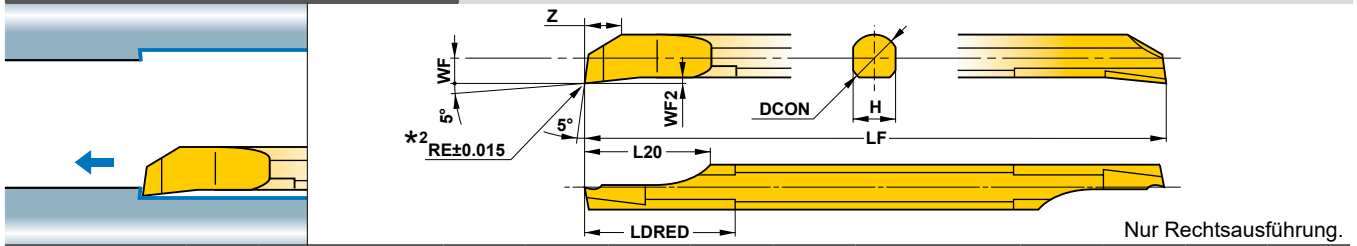

Bestellbezeichnung	Lager		Spanbrecher	Abmessungen (mm)										
	Hartmetall	Beschichtet		DMIN *1		RE	DCON	LF	L20	LDRED	WF	WF2	H	Z
	TF15	VP15TF		l/d ≤ 3	l/d > 3									
CB02RS	●	●	ohne	2.2	3.6	0.05	2	50	5	6	1	0.25	1.8	1.4
CB02RS-B	●	●	mit	2.2	3.9	0.05	2	50	5	6	1	0.25	1.8	1.4
CB02RS-01	●	●	ohne	2.2	3.6	0.1	2	50	5	6	1	0.25	1.8	1.4
CB02RS-01B	●	●	mit	2.2	4.2	0.1	2	50	5	6	1	0.25	1.8	1.4
CB02RS-02	●	●	ohne	2.2	3.6	0.2	2	50	5	6	1	0.25	1.8	1.4
CB02RS-02B	●	●	mit	2.2	4.9	0.2	2	50	5	6	1	0.25	1.8	1.4
CB03RS	●	●	ohne	3.2	4.2	0.05	3	50	7.5	9	1.5	0.35	2.7	2.3
CB03RS-B	●	●	mit	3.2	4.4	0.05	3	50	7.5	9	1.5	0.35	2.7	2.3
CB03RS-01	●	●	ohne	3.2	4.2	0.1	3	50	7.5	9	1.5	0.35	2.7	2.3
CB03RS-01B	●	●	mit	3.2	4.5	0.1	3	50	7.5	9	1.5	0.35	2.7	2.3
CB03RS-02	●	●	ohne	3.2	4.2	0.2	3	50	7.5	9	1.5	0.35	2.7	2.3
CB03RS-02B	●	●	mit	3.2	4.8	0.2	3	50	7.5	9	1.5	0.35	2.7	2.3
CB04RS	●	●	ohne	4.2	5.1	0.05	4	60	10	12	2	0.45	3.6	3.1
CB04RS-B	●	●	mit	4.2	5.2	0.05	4	60	10	12	2	0.45	3.6	3.1
CB04RS-01	●	●	ohne	4.2	5.1	0.1	4	60	10	12	2	0.45	3.6	3.1
CB04RS-01B	●	●	mit	4.2	5.3	0.1	4	60	10	12	2	0.45	3.6	3.1
CB04RS-02	●	●	ohne	4.2	5.1	0.2	4	60	10	12	2	0.45	3.6	3.1
CB04RS-02B	●	●	mit	4.2	5.5	0.2	4	60	10	12	2	0.45	3.6	3.1
CB05RS	●	●	ohne	5.2	6.0	0.05	5	70	12.5	15	2.5	0.55	4.5	3.9
CB05RS-B	●	●	mit	5.2	6.1	0.05	5	70	12.5	15	2.5	0.55	4.5	3.9
CB05RS-02	●	●	ohne	5.2	6.0	0.2	5	70	12.5	15	2.5	0.55	4.5	3.9
CB05RS-02B	●	●	mit	5.2	6.4	0.2	5	70	12.5	15	2.5	0.55	4.5	3.9
CB06RS	●	●	ohne	6.2	7.2	0.05	6	75	12.5	18	3	0.65	5.4	4.7
CB06RS-B	●	●	mit	6.2	7.3	0.05	6	75	12.5	18	3	0.65	5.4	4.7
CB06RS-02	●	●	ohne	6.2	7.2	0.2	6	75	12.5	18	3	0.65	5.4	4.7
CB06RS-02B	●	●	mit	6.2	7.8	0.2	6	75	12.5	18	3	0.65	5.4	4.7
CB07RS	●	●	ohne	7.2	8.6	0.05	7	85	12.5	21	3.5	0.75	6.3	5.5
CB07RS-B	●	●	mit	7.2	8.8	0.05	7	85	12.5	21	3.5	0.75	6.3	5.5
CB07RS-02	●	●	ohne	7.2	8.6	0.2	7	85	12.5	21	3.5	0.75	6.3	5.5
CB07RS-02B	●	●	mit	7.2	9.2	0.2	7	85	12.5	21	3.5	0.75	6.3	5.5
CB08RS	●	●	ohne	8.2	9.5	0.05	8	95	15	24	4	0.85	7.2	6.3
CB08RS-B	●	●	mit	8.2	9.6	0.05	8	95	15	24	4	0.85	7.2	6.3
CB08RS-02	●	●	ohne	8.2	9.5	0.2	8	95	15	24	4	0.85	7.2	6.3
CB08RS-02B	●	●	mit	8.2	9.8	0.2	8	95	15	24	4	0.85	7.2	6.3

\*1 DMIN : Min. Durchmesser

\*2 Das Maß RE stellt die Größe vor dem Schleifen eines Spanbrechers dar.

## SCHNITTDATENEMPFEHLUNGEN

Material	Micro-Mini Twin CB				Micro-Mini Twin CR		
	Schnittgeschw. (m/min)	Vorschub (mm/U.)	Schnitttiefe (mm)	l/d	Schnittgeschw. (m/min)	Vorschub (mm/U.)	
						03RS/04RS	05RS
<b>P</b> C-Stahl, Leg. Stahl 180–350HB	80 (40–120)	0.03 (0.01–0.05)	0.2 (0.1–0.3)	3–5	80 (40–120)	0.02 (0.01–0.03)	0.03 (0.01–0.05)
<b>M</b> Rostfreier Stahl ≤200HB	80 (40–120)	0.03 (0.01–0.05)	0.2 (0.1–0.3)	3–5	80 (40–120)	0.02 (0.01–0.03)	0.03 (0.01–0.05)
<b>K</b> Grauguss ≤350MPa	80 (40–120)	0.03 (0.01–0.05)	0.2 (0.1–0.3)	3–5	80 (40–120)	0.03 (0.01–0.05)	0.03 (0.01–0.05)
<b>N</b> Nichteisen Material	120 (80–160)	0.05 (0.01–0.08)	0.3 (0.1–0.5)	3–5	120 (80–160)	0.03 (0.01–0.05)	0.05 (0.01–0.08)

Hinweis 1) Einsatz von Kühlschmierstoff wird empfohlen.

Hinweis 2) Empfohlene Werkzeug-Ausraglänge des Typs CR beträgt LU+2mm.

BOHRSTANGEN

# MICRO-MINI TWIN

## CR

Zum Innenkopieren.

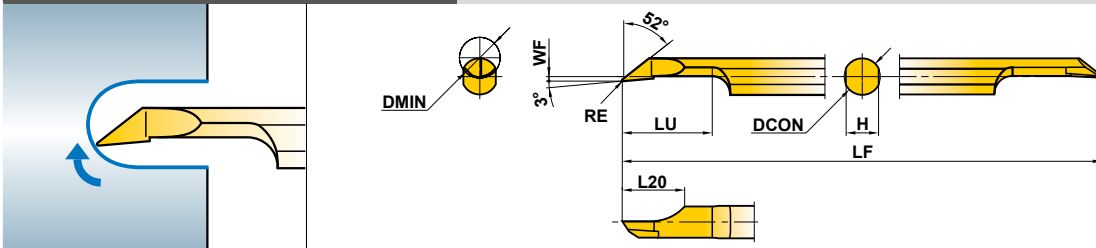

Nur Rechtsausführung.

Bestellbezeichnung	Lager		Spanbrecher	Abmessungen (mm)							
	Hartmetall	Beschichtet		DMIN	RE	DCON	LF	LU	L20	WF	H
	TF15	VP15TF									
CR03RS-01	●	●	ohne	3.5	0.1	3	50	8	6	0.15	2.7
CR03RS-01B	●	●	mit	3.5	0.1	3	50	8	6	0.15	2.7
CR04RS-01	●	●	ohne	4.5	0.1	4	60	10	7	0.15	3.6
CR04RS-01B	●	●	mit	4.5	0.1	4	60	10	7	0.15	3.6
CR05RS-01	●	●	ohne	5.5	0.1	5	70	12	8	0.15	4.5
CR05RS-01B	●	●	mit	5.5	0.1	5	70	12	8	0.15	4.5

E

BOHRSTANGEN

## SCHNITTDATENEMPFEHLUNGEN

Material	Micro-Mini Twin <b>CB</b>				Micro-Mini Twin <b>CR</b>		
	Schnittgeschw. (m/min)	Vorschub (mm/U.)	Schnitttiefe (mm)	l/d	Schnittgeschw. (m/min)	Vorschub (mm/U.)	
						03RS/04RS	05RS
<b>P</b> C-Stahl, Leg. Stahl 180–350HB	80 (40–120)	0.03 (0.01–0.05)	0.2 (0.1–0.3)	3–5	80 (40–120)	0.02 (0.01–0.03)	0.03 (0.01–0.05)
<b>M</b> Rostfreier Stahl ≤200HB	80 (40–120)	0.03 (0.01–0.05)	0.2 (0.1–0.3)	3–5	80 (40–120)	0.02 (0.01–0.03)	0.03 (0.01–0.05)
<b>K</b> Grauguss ≤350MPa	80 (40–120)	0.03 (0.01–0.05)	0.2 (0.1–0.3)	3–5	80 (40–120)	0.03 (0.01–0.05)	0.03 (0.01–0.05)
<b>N</b> Nichteisen Material	120 (80–160)	0.05 (0.01–0.08)	0.3 (0.1–0.5)	3–5	120 (80–160)	0.03 (0.01–0.05)	0.05 (0.01–0.08)

Hinweis 1) Einsatz von Kühlschmierstoff wird empfohlen.

Hinweis 2) Empfohlene Werkzeug-Ausraglänge des Typs CR beträgt LU+2mm.

● : Lagerstandard.



## ■ HINWEISE FÜR DEN EINSATZ VON MICRO-MINI BOHRSTANGEN

● Einsatz des Halters bei allgemeiner Bearbeitung / kleine Drehautomaten:

① Setzen Sie die Bohrstange vorsichtig in den Halter ein, um einen Bruch der zweiten Schneidkante zu vermeiden!

Zu Bild 1: ... Bei Kontakt der Bohrstange mit der Innenfläche des Halters, kann es zu Ausbrüchen kommen.

② Beim Spannen der Bohrstange im Halter, kann es zu Beschädigungen der Bohrstange bzw. der zweiten Schneidkante kommen. Spannen Sie die Schrauben mit dem vorgegeben Anziehmoment. Achten Sie darauf, dass keine Spannschraube nahe der zweiten Schneidkante ist, da diese brechen könnte.

© Bei der Verwendung von Mitsubishi Materials-Halterungen: Bei der Verwendung von Halterungen mit einem Werkzeugüberhang der empfohlenen Größe muss darauf geachtet werden, die 3. Klemmschraube vor der Bearbeitung zu entfernen. (RBH1620N, RBH19020N, RBH2020N und RBH2520N haben keine 3. Klemmschraube.) Der eingestellte Anzugsmomentwert für die Klemmschraube beträgt 2,0 N•m.

● Beim Einsatz des Vierkanthalters :

① Beim Einbau der Bohrstange in den Halter achten Sie bitte darauf, dass die MICRO-MINI Bohrstange an der Referenzfläche anliegt.

② Versichern Sie sich, dass die Spannschrauben gespannt sind. Die empfohlenen Anziehmomente sind in der Tabelle der Standard Bohrstangen zu finden (E026). Ziehen Sie die Spannschrauben richtig an, andernfalls kann eine feste Spannung nicht garantiert werden.

③ Spannen Sie die Spannschraube nicht ohne Bohrstange, andernfalls kann es zur Verformung der Spannbrücke kommen.

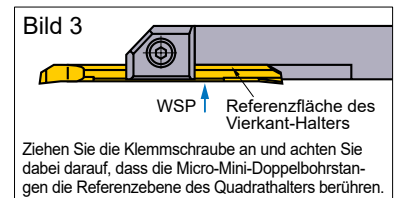
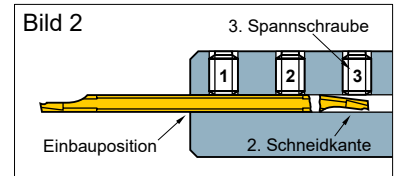
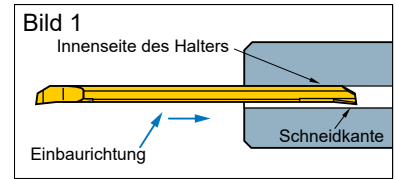

Ziehen Sie die Klemmschraube an und achten Sie dabei darauf, dass die Micro-Mini-Doppelbohrstangen die Referenzebene des Quadrathalters berühren.

## BEARBEITUNGSMETHODEN TYP CR

### ● Profildrehen

Durch Aufbohren eines vorbereiteten Loches wird die Bearbeitungszeit verkürzt und die Spankontrolle verbessert.

<Schnittdaten>

Material : DIN S20C  
 Halter : CR05RS-01B  
 Schnittgeschw : 80m/min  
 Vorschub : 0.05mm/U.  
 Schnitttiefe : 0.05mm  
 Naßbearbeitung

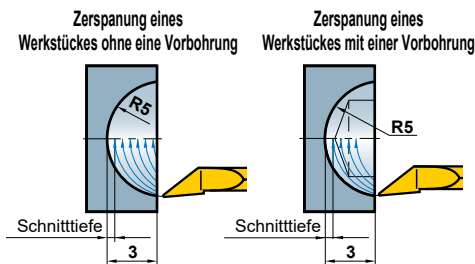

### ● Innenplandrehen

Durch Aufbohren eines vorbereiteten Loches wird die Bearbeitungszeit verkürzt und die Spankontrolle verbessert.

<Schnittdaten>

Material : DIN S20C  
 Halter : CR05RS-01B  
 Schnittgeschw : 80m/min  
 Vorschub : 0.05mm/U.  
 Schnitttiefe : 0.05mm  
 Nassbearbeitung

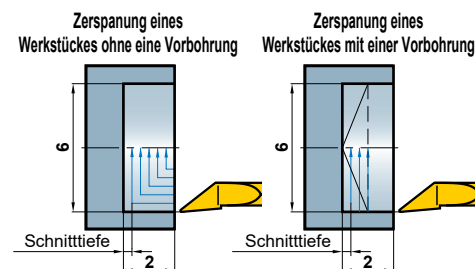

## ■ BENUTZERHINWEISE

### Profildrehen, Innenbearbeitung

Die Schneidkante sollte die Mittelachse des Werkstücks nicht überschreiten.

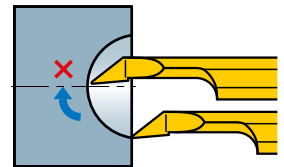

Falls die Schneidkante die Mittelachse des Werkstücks überquert, kann es zu einem Bruch der Schneidkante kommen.

### Kopierfräsen

Die Schnitttiefe sollte geringer sein als der WSP-Eckradius.

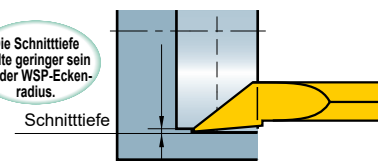

Bei Schnitttiefen größer als der der WSP-Eckradius entstehen Grate.



# BOHRSTANGEN

## MICRO-MINI BOHRSTANGEN

- VHM-Bohrstangen für kleine Durchmesser  $\phi 3.2\text{mm}$ .
- $l/d$  ist 5x Durchmesser.
- Schneidkante kann modifiziert werden, dadurch für einen breiten Anwendungsbereich geeignet (Gewindedrehen, -stechen, -kopieren, etc.).

### STANDARD BOHRSTANGEN (VOLLHARTMETALLBOHRSTANGEN)

Bestellbezeichnung	Lager	Abmessungen (mm)						Abbildung
		CW	DCON	LF	LDRED	DMIN	F2	
	TF15							
C03FR-BLS	★	2.0	3	80	15	3.2	1.0	
C04FR-BLS	★	2.5	4	80	20	4.2	1.5	
C05HR-BLS	★	3.0	5	100	25	5.2	2.0	

Nur Rechtsausführung.

### SCHNITTDATENEMPFEHLUNGEN

	Material	Schnittgeschw. (m/min)	Vorschub (mm/U.)	Schnittiefe (mm)	l/d	Schneidkante (mm)	
						*Eckenradius oder BCH	*Verfasung
P	C-Stahl, Leg. Stahl 180–350HB	40 (30–50)	0.05 (–0.1)	0.2 (0.1–0.3)	5	0.1–0.5	0.01–0.05
M	Rostfreier Stahl ≤200HB	40 (30–50)	0.05 (–0.1)	0.2 (0.1–0.3)	5	≤0.4	≤0.03 (nicht unbedingt notwendig)
K	Grauguss ≤350MPa	40 (30–50)	0.05 (–0.05)	0.2 (0.1–0.3)	5	0.1–0.5	0.01–0.05
N	Aluminiumlegierung	80 (60–100)	0.05 (–0.1)	0.3 (0.1–0.5)	5	0.1–0.5	≤0.03 (nicht unbedingt notwendig)

\* Schneidkante ist nicht verfasst. Bitte verfasen Sie die Schneidkante je nach Anwendungsfall vor dem Einsatz.

### ■ SCHLEIFEN DER VOLLHARTMETALLBOHRSTANGE

- Bohrstangen können im Lieferzustand zum Ausdrehen und Einstechen verwendet werden. Sie können aber auch entsprechend den unteren Abbildungen neu angeschliffen werden.
- Zur Formgebung und Nachschleifen benutzen Sie eine Diamantschleifscheibe #250 ~ #400. Schleifen Sie je nach Anwendung, entsprechend der Abbildungen.

Anwendung	Ausdrehen	Stechen	Gewindedrehen

● : Lagerstandard. ★ : Lagerstandard in Japan.

# ■ RUNDE AUSFÜHRUNG

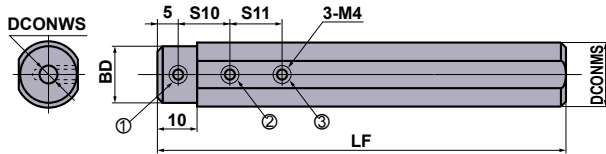

RBH158...N, RBH16...N, RBH190...N

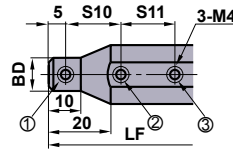

RBH20...N, RBH25...N, RBH254...N

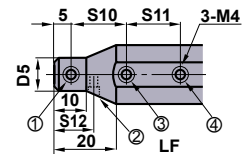

RBH22...N

Bestellbezeichnung	Lager	Abmessungen (mm)						Micro-Mini C	Micro-Mini Twin		*1 Spannschraube				Schlüssel	Drehmoment (N • m)
		DCONMS	DCONWS	BD	LF	S10	S11		S12	CB	CR	①	②	③		
RBH15820N	★	15.875	2	15	100	10	—	—	02RS(-B) 02RS-0(B)	—	B	B	—	—	HKY20F	2.0
RBH15830N	★	15.875	3	15	100	10	10	03FR-BLS	03RS(-B) 03RS-0(B)	03RS-01(B)	A	A	A	—	HKY20F	2.0
RBH15840N	★	15.875	4	15	100	15	15	04FR-BLS	04RS(-B) 04RS-0(B)	04RS-01(B)	A	A	A	—	HKY20F	2.0
RBH15850N	★	15.875	5	15	100	15	15	05HR-BLS	05RS(-B) 05RS-0(B)	05RS-01(B)	A	A	A	—	HKY20F	2.0
RBH15860N	★	15.875	6	15	100	15	15	—	06RS(-B) 06RS-0(B)	—	A	A	A	—	HKY20F	2.0
RBH15870N	★	15.875	7	15	100	20	20	—	07RS(-B) 07RS-0(B)	—	A	A	A	—	HKY20F	2.0
RBH15880N	★	15.875	8	15	100	20	20	—	08RS(-B) 08RS-0(B)	—	D	D	D	—	HKY20F	2.0
RBH1620N	●	16	2	15	100	10	—	—	02RS(-B) 02RS-0(B)	—	B	B	—	—	HKY20F	2.0
RBH1630N	●	16	3	15	100	10	10	03FR-BLS	03RS(-B) 03RS-0(B)	03RS-01(B)	A	A	A	—	HKY20F	2.0
RBH1640N	●	16	4	15	100	15	15	04FR-BLS	04RS(-B) 04RS-0(B)	04RS-01(B)	A	A	A	—	HKY20F	2.0
RBH1650N	●	16	5	15	100	15	15	05HR-BLS	05RS(-B) 05RS-0(B)	05RS-01(B)	A	A	A	—	HKY20F	2.0
RBH1660N	●	16	6	15	100	15	15	—	06RS(-B) 06RS-0(B)	—	A	A	A	—	HKY20F	2.0
RBH1670N	●	16	7	15	100	20	20	—	07RS(-B) 07RS-0(B)	—	A	A	A	—	HKY20F	2.0
RBH1680N	★	16	8	15	100	20	20	—	08RS(-B) 08RS-0(B)	—	D	D	D	—	HKY20F	2.0
*2 RBH19020N	★	19.05	2	18	125	10	—	—	02RS(-B) 02RS-0(B)	—	C	C	—	—	HKY20F	2.0
*2 RBH19030N	★	19.05	3	18	125	10	10	03FR-BLS	03RS(-B) 03RS-0(B)	03RS-01(B)	B	B	B	—	HKY20F	2.0
*2 RBH19040N	★	19.05	4	18	125	15	15	04FR-BLS	04RS(-B) 04RS-0(B)	04RS-01(B)	B	B	B	—	HKY20F	2.0
*2 RBH19050N	★	19.05	5	18	125	15	15	05HR-BLS	05RS(-B) 05RS-0(B)	05RS-01(B)	B	B	B	—	HKY20F	2.0
*2 RBH19060N	★	19.05	6	18	125	15	15	—	06RS(-B) 06RS-0(B)	—	B	B	B	—	HKY20F	2.0
*2 RBH19070N	★	19.05	7	18	125	20	20	—	07RS(-B) 07RS-0(B)	—	B	B	B	—	HKY20F	2.0
RBH19080N	★	19.05	8	18	125	20	20	—	08RS(-B) 08RS-0(B)	—	A	A	A	—	HKY20F	2.0
RBH2020N	★	20	2	11	125	10	—	—	02RS(-B) 02RS-0(B)	—	A	A	—	—	HKY20F	2.0
RBH2030N	★	20	3	12	125	10	10	03FR-BLS	03RS(-B) 03RS-0(B)	03RS-01(B)	A	A	B	—	HKY20F	2.0
RBH2040N	★	20	4	13	125	15	15	04FR-BLS	04RS(-B) 04RS-0(B)	04RS-01(B)	A	B	B	—	HKY20F	2.0
RBH2050N	★	20	5	14	125	15	15	05HR-BLS	05RS(-B) 05RS-0(B)	05RS-01(B)	A	B	B	—	HKY20F	2.0
RBH2060N	★	20	6	15	125	15	15	—	06RS(-B) 06RS-0(B)	—	A	B	B	—	HKY20F	2.0
RBH2070N	★	20	7	16	125	20	20	—	07RS(-B) 07RS-0(B)	—	A	B	B	—	HKY20F	2.0
RBH2080N	★	20	8	17	125	20	20	—	08RS(-B) 08RS-0(B)	—	A	A	A	—	HKY20F	2.0
RBH2220N	★	22	2	11	125	10	—	—	02RS(-B) 02RS-0(B)	—	A	B	—	A	HKY20F	2.0
RBH2230N	★	22	3	12	125	10	10	03FR-BLS	03RS(-B) 03RS-0(B)	03RS-01(B)	A	B	C	A	HKY20F	2.0
RBH2240N	★	22	4	13	125	15	15	04FR-BLS	04RS(-B) 04RS-0(B)	04RS-01(B)	A	B	B	A	HKY20F	2.0
RBH2250N	★	22	5	14	125	15	15	05HR-BLS	05RS(-B) 05RS-0(B)	05RS-01(B)	A	B	B	A	HKY20F	2.0
RBH2260N	★	22	6	15	125	15	15	—	06RS(-B) 06RS-0(B)	—	A	B	B	A	HKY20F	2.0
RBH2270N	★	22	7	16	125	20	20	—	07RS(-B) 07RS-0(B)	—	A	B	B	A	HKY20F	2.0
RBH2280N	★	22	8	17	125	20	20	—	08RS(-B) 08RS-0(B)	—	A	B	B	A	HKY20F	2.0
RBH2520N	★	25	2	11	150	10	—	—	02RS(-B) 02RS-0(B)	—	A	B	—	—	HKY20F	2.0
RBH2530N	★	25	3	12	150	10	10	03FR-BLS	03RS(-B) 03RS-0(B)	03RS-01(B)	A	B	C	—	HKY20F	2.0
RBH2540N	★	25	4	13	150	15	15	04FR-BLS	04RS(-B) 04RS-0(B)	04RS-01(B)	A	C	C	—	HKY20F	2.0
RBH2550N	★	25	5	14	150	15	15	05HR-BLS	05RS(-B) 05RS-0(B)	05RS-01(B)	A	C	C	—	HKY20F	2.0
RBH2560N	★	25	6	15	150	15	15	—	06RS(-B) 06RS-0(B)	—	A	C	C	—	HKY20F	2.0
RBH2570N	★	25	7	16	150	20	20	—	07RS(-B) 07RS-0(B)	—	A	C	C	—	HKY20F	2.0
RBH2580N	★	25	8	17	150	20	20	—	08RS(-B) 08RS-0(B)	—	A	B	B	—	HKY20F	2.0
RBH25420N	★	25.4	2	11	150	10	—	—	02RS(-B) 02RS-0(B)	—	A	B	—	—	HKY20F	2.0
RBH25430N	★	25.4	3	12	150	10	10	03FR-BLS	03RS(-B) 03RS-0(B)	03RS-01(B)	A	B	C	—	HKY20F	2.0
RBH25440N	★	25.4	4	13	150	15	15	04FR-BLS	04RS(-B) 04RS-0(B)	04RS-01(B)	A	C	C	—	HKY20F	2.0
RBH25450N	★	25.4	5	14	150	15	15	05HR-BLS	05RS(-B) 05RS-0(B)	05RS-01(B)	A	C	C	—	HKY20F	2.0
RBH25460N	★	25.4	6	15	150	15	15	—	06RS(-B) 06RS-0(B)	—	A	C	C	—	HKY20F	2.0
RBH25470N	★	25.4	7	16	150	20	20	—	07RS(-B) 07RS-0(B)	—	A	C	C	—	HKY20F	2.0
RBH25480N	★	25.4	8	17	150	20	20	—	08RS(-B) 08RS-0(B)	—	A	B	B	—	HKY20F	2.0

\*1 Bestellbezeichnung der Spannschrauben: A=HSS04004, B=HSS04006, C=HSS04008, D=HSS04003 \*2 Neue Bestellbezeichnung.

Alte Bestellbezeichnung	Neue Bestellbezeichnung	Alte Bestellbezeichnung	Neue Bestellbezeichnung
RBH1920N	RBH19020N	RBH1950N	RBH19050N
RBH1930N	RBH19030N	RBH1960N	RBH19060N
RBH1940N	RBH19040N	RBH1970N	RBH19070N

ERSATZTEILE > N001  
TECHNISCHE DATEN > P001

# MICRO-MINI TWIN

**■ VIERKANT AUSFÜHRUNG**

Typ CB (Bohrstange passt auf Aufnahme)

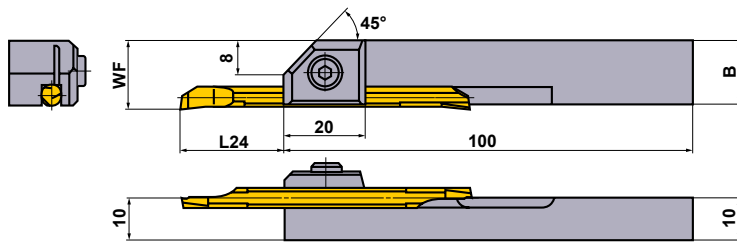

Typ CR (Bohrstange passt auf Aufnahme)

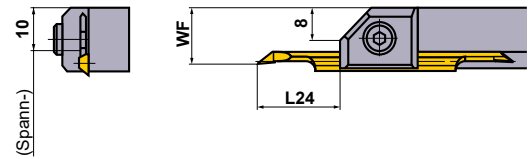

Bestellbezeichnung	Lager	Abmessungen (mm)						Micro-Mini Twin		Spannschraube	Schlüssel	Drehmoment (N • m)
		WF		L24 *		B		CB	CR			
		CB	CR	CB	CR	CB	CR					
<b>SBH1020R</b>	★	13	—	6–24 (6–10)	—	12.9	02RS(-B) 02RS-0(B)	—	HSC04010	HKY30R	4.8	
<b>SBH1030R</b>	★	14	12.65	8.5–22 (9–15)	11–19.5 (12)	13.8	03RS(-B) 03RS-0(B)	03RS-01(B)	HSC05012	HKY40R	9.5	
<b>SBH1040R</b>	★	15	13.15	11–29.5 (12–20)	13–27.5 (14)	14.7	04RS(-B) 04RS-0(B)	04RS-01(B)	HSC05012	HKY40R	9.5	
<b>SBH1050R</b>	★	16	13.65	13.5–37 (15–25)	15–35.5 (16)	15.6	05RS(-B) 05RS-0(B)	05RS-01(B)	HSC05012	HKY40R	9.5	
<b>SBH1060R</b>	★	17	—	13.5–42 (18–30)	—	16.5	06RS(-B) 06RS-0(B)	—	HSC05012	HKY40R	9.5	
<b>SBH1070R</b>	★	18	—	13.5–52 (21–35)	—	17.4	07RS(-B) 07RS-0(B)	—	HSC05012	HKY40R	9.5	

Hinweis 1) MICRO-DEX und MICRO-MINI passen nicht auf Standard quadratische Drehhalter.

★ L24 ist die Überhanglänge für ein ausreichendes Einspannen und ( ) die empfohlene Länge für die Bearbeitung von Kohlenstoff- und legiertem Stahl.

E

BOHRSTANGEN

# F BOHRSTANGEN

- Der kleinste Bearbeitungsdurchmesser ist  $\phi 10$ .
- 11° positive WSP.
- Schraubklemmung.
- l/d ist 3 bis 5x Durchmesser (Hartmetallschaft ist 7-8x Durchmesser).

## FSTU1

TP WSP

Leicht	Glatt
R/L  (08,09,11)	 (08,09,11)
PKD  (09,11)	PKD  (08,09,11)





Abb. zeigt Rechtsausführung.

Bestellbezeichnung	Lager		WSP Bezeichnung	Abmessungen (mm)							*  		
	R	L		DCON	LF	LDRED	WF	H	GAMF	DMIN	Spannschraube	Schlüssel	
FSTU108R/L	●	●	TPGX TPMX	0802	8	125	18	5	7	15°	10	CS200T	TKY06F
FSTU110R/L	●	●		0902	10	150	22	6	9	13°	12	CS250T	TKY08F
FSTU112R/L	●	●		0902	12	180	25	8	11	10°	16	CS250T	TKY08F
FSTU116R/L	●	●		1103	16	200	30	11	14	7°	22	CS300890T	TKY08F

\* Spannmoment (N • m) : CS200T=0.6, CS250T=1.0, CS300890T=1.0

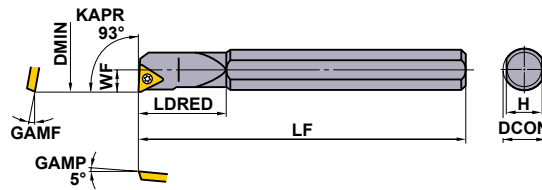
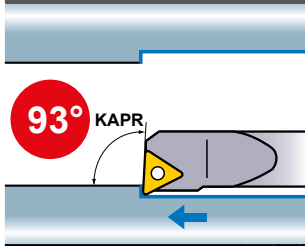
## FSTU2

Hartmetallschaft

TP WSP

Leicht	Glatt
R/L  (08,09,11)	 (08,09,11)
PKD  (09,11)	PKD  (08,09,11)





Abb. zeigt Rechtsausführung.

Bestellbezeichnung	Lager		WSP Bezeichnung	Abmessungen (mm)							*  		
	R	L		DCON	LF	LDRED	WF	H	GAMF	DMIN	Spannschraube	Schlüssel	
FSTU208R/L	●	●	TPGX TPMX	0802	8	125	13	5	7	15°	10	CS200T	TKY06F
FSTU210R/L	●	●		0902	10	150	16	6	9	13°	12	CS250T	TKY08F
FSTU212R/L	●	★		0902	12	180	19	8	11	10°	16	CS250T	TKY08F
FSTU216R/L	●	★		1103	16	200	26	11	14	7°	22	CS300890T	TKY08F

\* Spannmoment (N • m) : CS200T=0.6, CS250T=1.0, CS300890T=1.0

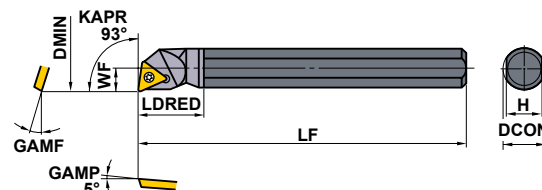
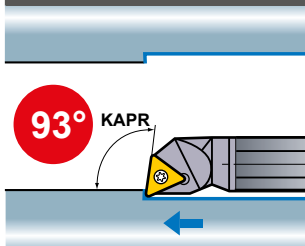
## SCHNITTDATENEMPFEHLUNGEN

Stahlschaft			l/d ≤ 3			l/d = 3–4 (Schaftdurchmesser ≥ 25mm)		
Hartmetallschaft			l/d ≤ 5			l/d = 6–7		
Material	Härte	Schnittmodus	Schnittgeschw. (m/min)	Vorschub (mm/U.)	Schnitttiefe (mm)	Schnittgeschw. (m/min)	Vorschub (mm/U.)	Schnitttiefe (mm)
P C-Stahl Leg. Stahl	180–350HB	Leichtzerspanung	130 (90–160)	0.1 (0.05–0.15)	0.2	120 (80–150)	0.1 (0.05–0.15)	0.2
		Mittlere Zerspanung	90 (60–120)	0.25 (0.15–0.35)	–3.0	80 (50–110)	0.15 (0.1–0.2)	–1.5
M Rostfreier Stahl	≤200HB	Leichtzerspanung	140 (100–180)	0.1 (0.05–0.15)	0.2	140 (100–180)	0.1 (0.05–0.15)	0.2
		Mittlere Zerspanung	70 (50–90)	0.2 (0.15–0.25)	–2.0	60 (40–80)	0.15 (0.1–0.2)	–1.0
N Aluminiumlegierung	—	Leichtzerspanung	300 (200–400)	0.1 (0.05–0.15)	0.2	300 (200–400)	0.1 (0.05–0.15)	0.2
		Mittlere Zerspanung	200 (150–250)	0.1 (0.05–0.15)	–2.0	200 (150–250)	0.1 (0.05–0.15)	–1.5

Hinweis 1) Die Fotos der Wendeschneidplatten dienen lediglich als Beispiel. Die Buchstaben beziehen sich auf den Spanbrecher und die Abmessungen auf den Innenkreisdurchmesser.

Hinweis 2) Die angegebenen Maße gelten für Wendeschneidplatten mit Eckenradius RE 0.4.

Hinweis 3) Bei der Verwendung von Wendeschneidplatten mit rechtsseitigem und linksseitigem Spanbrecher verwenden Sie bitte den linksseitigen Spanbrecher für den rechten Halter und den rechtsseitigen Spanbrecher für den linken Halter.

TP  WSP	> A162, A163
PKD WSP	> B070
ERSATZTEILE	> N001
TECHNISCHE DATEN	> P001

# BOHRSTANGEN

## F BOHRSTANGEN

- Der kleinste Bearbeitungsdurchmesser ist  $\phi 22$ .
- 11° positive WSP.
- Spannfingerklemmung.
- l/d ist 3 bis 5x Durchmesser (Hartmetallschaft ist 7-8x Durchmesser).

### FCTU1

TP WSP

M-Klasse	M-Klasse	G-Klasse
Standard  (11,16)	 (11,16)	R/L  (11,16)
G-Klasse  (11,16)	PCBN/PKD  (11,16)	



Abb. zeigt Rechtsausführung.

Bestellbezeichnung	Lager		WSP Bezeichnung	Abmessungen (mm)						DMIN						
	R	L		DCON	LF	LDRED	WF	H	GAMF							
FCTU116R/L	●	●	TPMN TPMR TPGN TPGR	1103	16	200	30	11	14	7°	22	—	—	C3	CBT2N	HKY25R
FCTU120R/L	●	●		1603	20	200	37	13	18	5°	26	—	—	C4	CBT3F	HKY30R
FCTU125R/L (4 Flächen am Schaft)	●	●		1603	25	250	40	16	22	5°	32	PT32	BCP202	C4	CBT3F	HKY30R
FCTU132R/L (4 Flächen am Schaft)	●	●		1603	32	300	45	20	29	0°	40	PT32	BCP201	C4	CBT3F	HKY30R

\* Spannmoment (N · m) : C3=2.2, C4=3.3

E

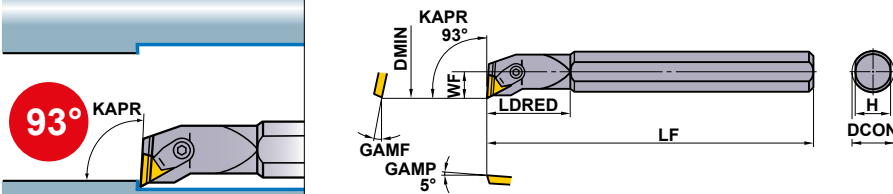
BOHRSTANGEN

### FCTU2

Hartmetallschaft

TP WSP

M-Klasse	M-Klasse	G-Klasse
 (11,16)	 (11,16)	R/L  (11,16)
G-Klasse  (11,16)	PCBN/PKD  (11,16)	

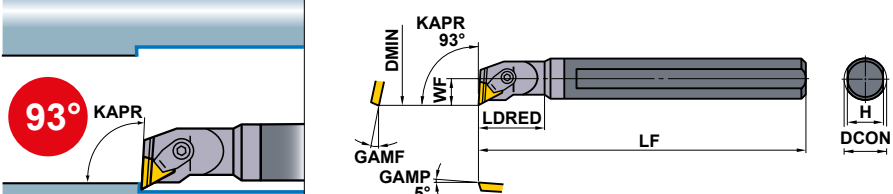

Nur Rechtsausführung lieferbar.

Bestellbezeichnung	Lager	WSP Bezeichnung	Abmessungen (mm)						DMIN						
	R		DCON	LF	LDRED	WF	H	GAMF							
FCTU216R	★	TPMN TPMR TPGN TPGR	1103	16	200	26	11	14	7°	22	—	—	C3	CBT2N	HKY25R
FCTU220R	★		1603	20	200	33	13	18	5°	26	—	—	C4	CBT3F	HKY30R
FCTU225R	★		1603	25	250	37	16	22	5°	32	PT32	BCP202	C4	CBT3F	HKY30R

\* Spannmoment (N · m) : C3=2.2, C4=3.3

Hinweis 1) Die Fotos der Wendschneidplatten dienen lediglich als Beispiel. Die Buchstaben beziehen sich auf den Spanbrecher und die Abmessungen auf den Innenkreisdurchmesser.

Hinweis 2) Die angegebenen Maße gelten für Wendschneidplatten mit Eckenradius RE 0.4 (Artikel von ☆ beschriftet mit RE 0.8)

Hinweis 3) Bei der Verwendung von Wendschneidplatten mit rechtsseitigem und linksseitigem Spanbrecher verwenden Sie bitte den linksseitigen Spanbrecher für den rechten Halter und den rechtsseitigen Spanbrecher für den linken Halter.

● : Lagerstandard. ★ : Lagerstandard in Japan.

TP WSP > A180, A181  
PCBN & PKD WSP > B062, B075

# F BOHRSTANGEN



- Der kleinste Bearbeitungsdurchmesser ist  $\phi 5.8$ .
- 7° positive WSP.
- Schraubklemmung.
- l/d ist 3 bis 5x Durchmesser (Hartmetallschaft ist 7-8x Durchmesser).

## FSWL1

WC $\odot$ WSP

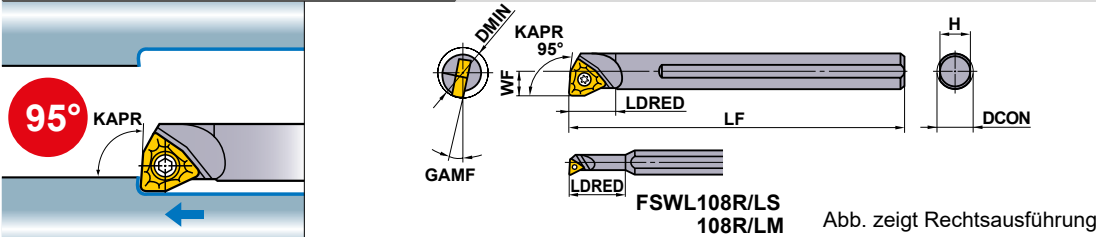
Schichten	Leicht
R/L	Standard
 (02,L3)	 (02,L3,04,06)
PCBN/PKD	
 (L3,04,06)	



Bestellbezeichnung	Lager		WSP Bezeichnung	Abmessungen (mm)							*  		
	R	L		DCON	LF	LDRED	WF	H	GAMF	DMIN	Spannschraube	Schlüssel	
FSWL108R/LS	●	●	WCMT WCGT	0201 $\odot$	8	100	19	2.9	7	17°	5.8	TS21	TKY06F
FSWL108R/LM	●	●	WCMT WCGT WCMW	L302 $\odot$	8	100	25	4	7	15°	8	TS2	TKY06F
FSWL108R/L	●	●	WCMT WCMW	0402 $\odot$	8	125	10	5	7	15°	10	TS25	TKY08F
FSWL110R/L	●	●		0402 $\odot$	10	150	12	6	9	13°	12	TS25	TKY08F
FSWL112R/L ☆	●	●		06T3 $\odot$	12	180	15	8	11	13°	16	TS4	TKY15F
FSWL116R/L ☆	●	●		06T3 $\odot$	16	200	20	11	14	7°	22	TS4	TKY15F

\* Spannmoment (N • m) : TS21=0.6, TS2=0.6, TS25=1.0, TS4=3.5



## FSWL2

Hartmetallschaft

WC $\odot$ WSP

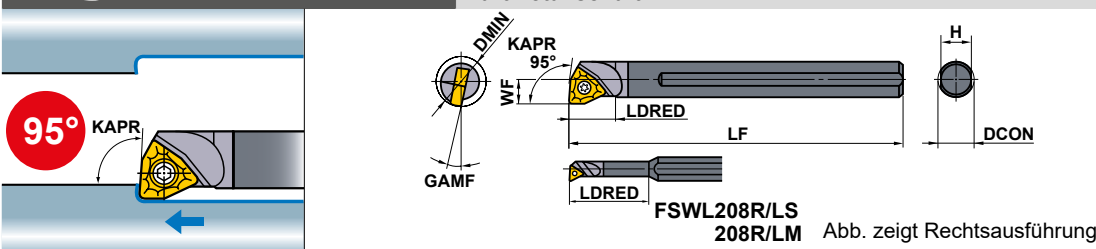
Schichten	Leicht
R/L	Standard
 (02,L3)	 (02,L3,04,06)
PCBN/PKD	
 (L3,04,06)	



Bestellbezeichnung	Lager		WSP Bezeichnung	Abmessungen (mm)							*  		
	R	L		DCON	LF	LDRED	WF	H	GAMF	DMIN	Spannschraube	Schlüssel	
FSWL208R/LS	●	●	WCMT WCGT	0201 $\odot$	8	122	25	2.9	7	17°	5.8	TS21	TKY06F
FSWL208R/LM	●	●	WCMT WCGT WCMW	L302 $\odot$	8	125	33	4	7	15°	8	TS2	TKY06F
FSWL208R/L	●	●	WCMT WCMW	0402 $\odot$	8	125	10	5	7	15°	10	TS25	TKY08F
FSWL210R/L	●	●		0402 $\odot$	10	150	12	6	9	13°	12	TS25	TKY08F
FSWL212R/L ☆	●	●		06T3 $\odot$	12	180	15	8	11	13°	16	TS4	TKY15F
FSWL216R/L ☆	●	●		06T3 $\odot$	16	200	20	11	14	7°	22	TS4	TKY15F

\* Spannmoment (N • m) : TS21=0.6, TS2=0.6, TS25=1.0, TS4=3.5

## SCHNITTDATENEMPFEHLUNGEN

Stahlschaft			l/d ≤ 3			l/d = 3–4 (Schaftdurchmesser ≥ 25mm)		
Hartmetallschaft			l/d ≤ 5			l/d = 6–7		
Material	Härte	Schnittmodus	Schnittgeschw. (m/min)	Vorschub (mm/U.)	Schnitttiefe (mm)	Schnittgeschw. (m/min)	Vorschub (mm/U.)	Schnitttiefe (mm)
P C-Stahl Leg. Stahl	180–350HB	Leichtzerspanung	130 (90–160)	0.1 (0.05–0.15)	0.2	120 (80–150)	0.1 (0.05–0.15)	0.2
		Mittlere Zerspanung	90 (60–120)	0.25 (0.15–0.35)	–3.0	80 (50–110)	0.15 (0.1–0.2)	–1.5
M Rostfreier Stahl	≤200HB	Leichtzerspanung	140 (100–180)	0.1 (0.05–0.15)	0.2	140 (100–180)	0.1 (0.05–0.15)	0.2
		Mittlere Zerspanung	70 (50–90)	0.2 (0.15–0.25)	–2.0	60 (40–80)	0.15 (0.1–0.2)	–1.0
N Aluminiumlegierung	—	Leichtzerspanung	300 (200–400)	0.1 (0.05–0.15)	0.2	300 (200–400)	0.1 (0.05–0.15)	0.2
		Mittlere Zerspanung	200 (150–250)	0.1 (0.05–0.15)	–2.0	200 (150–250)	0.1 (0.05–0.15)	–1.5

WC $\odot$ WSP > A173  
PCBN & PKD WSP > B060, B072

ERSATZTEILE > N001  
TECHNISCHE DATEN > P001



# BOHRSTANGEN

## S BOHRSTANGEN

- Der kleinste Bearbeitungsdurchmesser ist  $\phi 11$ .
- ISO Standard.
- 7° positive WSP.
- Schraubklemmung.
- l/d ist 3 bis 5x Durchmesser (Hartmetallschaft ist 7-8x Durchmesser).

### S O O O STFC

### TC O O WSP

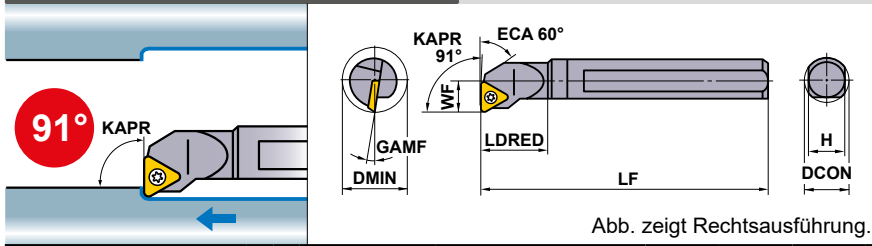





Schichten	Schichten	Leicht	Leicht
FP	FM	LP	LM
			
(09,11,16)	(09,11,16)	(09,11,16)	(09,11,16)
Mittel	Mittel	Glatt	PCBN/PKD
			
(09,11,16)	(09,11,16)	(11,16)	(09,11,16)

Abb. zeigt Rechtsausführung.

Bestellbezeichnung	Lager		WSP Bezeichnung	Abmessungen (mm)							*		
	R	L		DCON	LF	LDRED	WF	H	GAMF	DMIN	Spannschraube	Schlüssel	
S08FSTFCR/L09	●	●	TCMT TCGW	0902	8	80	12	6	7	15°	11	TS22	TKY06F
S10HSTFCR/L11	●	●	TCMW TCMT TCGW TCGT	1102	10	100	16	7	9	13°	13	TS25	TKY08F
S12KSTFCR/L11	●	●		1102	12	125	20	9	11	10°	16	TS25	TKY08F
S16MSTFCR/L11	●	●		1102	16	150	25	11	14	7°	20	TS25	TKY08F
S20QSTFCR/L16	☆	●		16T3	20	180	32	13	18	7°	25	TS4	TKY15F
S25RSTFCR/L16	☆	●		16T3	25	200	40	17	23	5°	32	TS4	TKY15F
S32SSTFCR/L16	☆	●		16T3	32	250	50	22	30	5°	40	TS4	TKY15F

\* Spannmoment (N • m) : TS22=0.6, TS25=1.0, TS4=3.5

### C O O O STFC

### Hartmetallschaft

### TC O O WSP

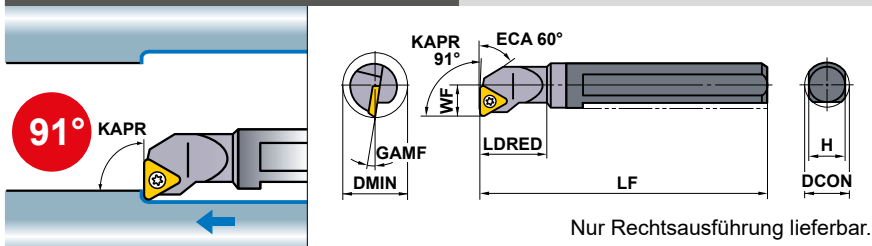

Schichten	Schichten	Leicht	Leicht
FP	FM	LP	LM
			
(09,11,16)	(09,11,16)	(09,11,16)	(09,11,16)
Mittel	Mittel	Glatt	PCBN/PKD
			
(09,11,16)	(09,11,16)	(11,16)	(11)

Nur Rechtsausführung lieferbar.

Bestellbezeichnung	Lager		WSP Bezeichnung	Abmessungen (mm)							*		
	R	L		DCON	LF	LDRED	WF	H	GAMF	DMIN	Spannschraube	Schlüssel	
C08HSTFCR09	●		TCMT TCGW	0902	8	100	12	6	7	15°	11	TS22	TKY06F
C10KSTFCR11	●		TCMW TCMT TCGW TCGT	1102	10	125	16	7	9	13°	13	TS25	TKY08F
C12MSTFCR11	●			1102	12	150	20	9	11	10°	16	TS25	TKY08F
C16RSTFCR11	●			1102	16	200	25	11	14	7°	20	TS25	TKY08F
C20SSTFCR16	☆	●		16T3	20	250	32	13	18	7°	25	TS4	TKY15F
C25TSTFCR16	☆	●		16T3	25	300	40	17	23	5°	32	TS4	TKY15F

\* Spannmoment (N • m) : TS22=0.6, TS25=1.0, TS4=3.5

Hinweis 1) Die Fotos der Wendeschneidplatten dienen lediglich als Beispiel. Die Buchstaben beziehen sich auf den Spanbrecher und die Abmessungen auf den Innendurchmesser

Hinweis 2) Die angegebenen Maße gelten für Wendeschneidplatten mit Eckenradius RE 0.4 (Artikel von ☆ beschriftet mit RE 0.8)

Hinweis 3) Bei der Verwendung von Wendeschneidplatten mit rechtsseitigem und linksseitigem Spanbrecher verwenden Sie bitte den linksseitigen Spanbrecher für den rechten Halter und den rechtsseitigen Spanbrecher für den linken Halter.

● : Lagerstandard.

TC O O WSP > A158–A160  
PCBN & PKD WSP > B059, B069



S <sup>○</sup> SDUC		DC <sup>○</sup> WSP										Schichten	Schichten	Leicht	Leicht
												FP	FM	LP	LM
												(07,11)	(07,11)	(07,11)	(07,11)
Bestellbezeichnung	Lager		WSP Bezeichnung	Abmessungen (mm)								*			
	R	L		DCON	LF	LDRED	WF	WF2	H	GAMF	DMIN	Spannschraube	Schlüssel		
S10HSDUCR/L07	●	●	DCMT DCET DCGT DCMW DCGW	0702 <sup>○</sup>	10	100	16	7	2.4	9	13°	13	TS25	TKY08F	
S12KSDUCR/L07	●	●		0702 <sup>○</sup>	12	125	20	9	3.4	11	10°	16	TS25	TKY08F	
S16MSDUCR/L07	●	●		0702 <sup>○</sup>	16	150	25	11	3.9	14	7°	20	TS25	TKY08F	
S20QSDUCR/L11 ☆	●	●		11T3 <sup>○</sup>	20	180	32	13	4.4	18	7°	25	TS4	TKY15F	
S25RSDUCR/L15 ☆	●	●		1504 <sup>○</sup>	25	200	40	17	6.9	23	5°	32	TS5	TKY25F	
S32SSDUCR/L15 ☆	●	●		1504 <sup>○</sup>	32	250	50	22	8.4	30	5°	40	TS5	TKY25F	
S40TSDUCR/L15 ☆	●	●	1504 <sup>○</sup>	40	300	63	27	9.4	37	5°	50	TS5	TKY25F		

\* Spannmoment (N • m) : TS25=1.0, TS4=3.5, TS5=7.5

C <sup>○</sup> SDUC		Vollhartmetallschaft DC <sup>○</sup> WSP										Schichten	Schichten	Leicht	Leicht
												FP	FM	LP	LM
												(07,11)	(07,11)	(07,11)	(07,11)
Bestellbezeichnung	Lager		WSP Bezeichnung	Abmessungen (mm)								*			
	R	L		DCON	LF	LDRED	WF	WF2	H	GAMF	DMIN	Spannschraube	Schlüssel		
C10KSDUCR07	●		DCMT DCET DCGT DCMW DCGW	0702 <sup>○</sup>	10	125	16	7	2.1	9	13°	13	TS25	TKY08F	
C12MSDUCR07	●			0702 <sup>○</sup>	12	150	20	9	3.1	11	10°	16	TS25	TKY08F	
C16RSDUCR07	●			0702 <sup>○</sup>	16	200	25	11	3.1	14	7°	20	TS25	TKY08F	
C20SSDUCR11 ☆	●			11T3 <sup>○</sup>	20	250	32	13	3.1	18	7°	25	TS4	TKY15F	
C25TSDUCR15 ☆	●			1504 <sup>○</sup>	25	300	40	17	4.9	23	5°	32	TS5	TKY25F	

\* Spannmoment (N • m) : TS25=1.0, TS4=3.5, TS5=7.5

## SCHNITTDATENEMPFEHLUNGEN

Stahlschaft			l/d ≤ 3			l/d = 3–4 (Schaftdurchmesser ≥ 25mm)		
Hartmetallschaft			l/d ≤ 5			l/d = 6–7		
Material	Härte	Schnittmodus	Schnittgeschw. (m/min)	Vorschub (mm/U.)	Schnitttiefe (mm)	Schnittgeschw. (m/min)	Vorschub (mm/U.)	Schnitttiefe (mm)
P C-Stahl Leg. Stahl	180–350HB	Leichtzerspanung	130 (90–160)	0.1 (0.05–0.15)	0.2	120 (80–150)	0.1 (0.05–0.15)	0.2
		Mittlere Zerspanung	90 (60–120)	0.25 (0.15–0.35)	–3.0	80 (50–110)	0.15 (0.1–0.2)	–1.5
M Rostfreier Stahl	≤200HB	Leichtzerspanung	140 (100–180)	0.1 (0.05–0.15)	0.2	140 (100–180)	0.1 (0.05–0.15)	0.2
		Mittlere Zerspanung	70 (50–90)	0.2 (0.15–0.25)	–2.0	60 (40–80)	0.15 (0.1–0.2)	–1.0
N Aluminiumlegierung	—	Leichtzerspanung	300 (200–400)	0.1 (0.05–0.15)	0.2	300 (200–400)	0.1 (0.05–0.15)	0.2
		Mittlere Zerspanung	200 (150–250)	0.1 (0.05–0.15)	–2.0	200 (150–250)	0.1 (0.05–0.15)	–1.5

DC<sup>○</sup> WSP > A147–A152  
PCBN & PKD WSP > B055, B055, B068

ERSATZTEILE > N001  
TECHNISCHE DATEN > P001

# BOHRSTANGEN

## S BOHRSTANGEN

- Der kleinste Bearbeitungsdurchmesser ist  $\phi 11$ .
- ISO Standard.
- 7° positive WSP.
- Schraubklemmung.
- l/d ist 3 bis 5x Durchmesser (Hartmetallschaft ist 7-8x Durchmesser).

S		SCLC		CC						WSP		Schichten	Schichten	Leicht	Leicht		
FP		FM		LP		LM											
Mittel		Mittel		Glatt		PCBN/PKD											
MP		MM															
								Abb. zeigt Rechtsausführung.		(06,09)		(06,09)		(06,09)		(06,09)	
Bestellbezeichnung	Lager		WSP Bezeichnung	Abmessungen (mm)						*							
	R	L		DCON	LF	LDRED	WF	H	GAMF	DMIN	Spannschraube	Schlüssel					
S08FSCLCR/L06	●	●		8	80	12	6	7	15°	11	TS25	TKY08F					
S10HSCLCR/L06	●	●	CCMB	10	100	16	7	9	13°	13	TS25	TKY08F					
S12KSCLCR/L06	●	●	CCMH	12	125	20	9	11	10°	16	TS25	TKY08F					
S16MSCLCR/L09	●	●	CCMT	16	150	25	11	14	7°	20	TS4	TKY15F					
S20QSCLCR/L09	☆	●	CCMW	20	180	32	13	18	7°	25	TS4	TKY15F					
S25RSCLCR/L12	☆	●	CCET	25	200	40	17	23	5°	32	TS5	TKY25F					
S32SSCLCR/L12	☆	●	CCGH	32	250	50	22	30	5°	40	TS5	TKY25F					
S40TSCLCR/L12	☆	●	CCGT	40	300	63	27	37	5°	50	TS5	TKY25F					
			CCGW														

\* Spannmoment (N • m) : TS25=1.0, TS4=3.5, TS5=7.5

C		SCLC		Hartmetallschaft						CC		WSP		Schichten	Schichten	Leicht	Leicht
FP		FM		LP		LM											
Mittel		Mittel		Glatt		PCBN/PKD											
MP		MM															
								Nur Rechtsausführung lieferbar.		(06,09)		(06,09)		(06,09)		(06,09)	
Bestellbezeichnung	Lager		WSP Bezeichnung	Abmessungen (mm)						*							
	R	L		DCON	LF	LDRED	WF	H	GAMF	DMIN	Spannschraube	Schlüssel					
C08HSCLCR06	●	●	CCMB	8	100	12	6	7	15°	11	TS25	TKY08F					
C10KSCLCR06	●	●	CCMH	10	125	16	7	9	13°	13	TS25	TKY08F					
C12MSCLCR06	●	●	CCMT	12	150	20	9	11	10°	16	TS25	TKY08F					
C16RSCLCR09	☆	●	CCMW	16	200	25	11	14	7°	20	TS4	TKY15F					
C20SSCLCR09	☆	●	CCET	20	250	32	13	18	7°	25	TS4	TKY15F					
			CCGH														
			CCGT														
			CCGW														

\* Spannmoment (N • m) : TS25=1.0, TS4=3.5

Hinweis 1) Die Fotos der Wendeschneidplatten dienen lediglich als Beispiel. Die Buchstaben beziehen sich auf den Spanbrecher und die Abmessungen auf den Innendurchmesser.

Hinweis 2) Die angegebenen Maße gelten für Wendeschneidplatten mit Eckenradius RE 0.4. (Artikel von ☆ beschriftet mit RE 0.8)

Hinweis 3) Bei der Verwendung von Wendeschneidplatten mit rechtsseitigem und linksseitigem Spanbrecher verwenden Sie bitte den linksseitigen Spanbrecher für den rechten Halter und den rechtsseitigen Spanbrecher für den linken Halter.

● : Lagerstandard. ☆ : Lagerstandard in Japan.

CC WSP

> A139–A145

PCBN & PKD WSP

> B051–B052, B067

SDQC			DCWSP								Schichten	Schichten	Leicht	Leicht
											FP	FM	LP	LM
											(07,11)	(07,11)	(07,11)	(07,11)
											Mittel	Mittel	Glatt	PCBN/PKD
											MP	MM		
											(07,11,15)	(07,11,15)	(07,11,15)	(07,11)
Bestellbezeichnung	Lager		WSP Bezeichnung	Abmessungen (mm)								*		
	R	L		DCON	LF	LDRED	WF	WF2	H	GAMF	DMIN	Spannschraube	Schlüssel	
S10HSDQCR/L07	●	●	DCMT DCET DCGT DCMW DCGW	0702	10	100	16	7	2.4	9	13°	13	TS25	TKY08F
S12KSDQCR/L07	●	●		0702	12	125	20	9	3.4	11	10°	16	TS25	TKY08F
S16MSDQCR/L07	●	●		0702	16	150	25	11	3.9	14	7°	20	TS25	TKY08F
S20QSDQCR/L11	☆	●		11T3	20	180	32	13	4.4	18	7°	25	TS4	TKY15F
S25RSDQCR/L15	☆	●		1504	25	200	40	17	6.9	23	5°	32	TS5	TKY25F
S32SSDQCR15	☆	●		1504	32	250	50	22	8.4	30	5°	40	TS5	TKY25F
S40TSDQCR15	☆	●		1504	40	300	63	27	9.4	37	5°	50	TS5	TKY25F

\* Spannmoment (N • m) : TS25=1.0, TS4=3.5, TS5=7.5

SDQC			DCWSP								Schichten	Schichten	Leicht	Leicht
											FP	FM	LP	LM
											(07,11)	(07,11)	(07,11)	(07,11)
											Mittel	Mittel	Glatt	PCBN/PKD
											MP	MM		
											(07,11,15)	(07,11,15)	(07,11,15)	(07,11)
Bestellbezeichnung	Lager		WSP Bezeichnung	Abmessungen (mm)								*		
	R	L		DCON	LF	LDRED	WF	WF2	H	GAMF	DMIN	Spannschraube	Schlüssel	
C10KSDQCR07	●		DCMT DCET DCGT DCMW DCGW	0702	10	125	16	7	2.1	9	13°	13	TS25	TKY08F
C12MSDQCR07	●			0702	12	150	20	9	3.1	11	10°	16	TS25	TKY08F
C16RSDQCR07	●			0702	16	200	25	11	3.1	14	7°	20	TS25	TKY08F
C20SSDQCR11	☆	●		11T3	20	250	32	13	3.1	18	7°	25	TS4	TKY15F
C25TSDQCR15	☆	★		1504	25	300	40	17	4.9	23	5°	32	TS5	TKY25F

\* Spannmoment (N • m) : TS25=1.0, TS4=3.5, TS5=7.5

## SCHNITTDATENEMPFEHLUNGEN

Stahlschaft			l/d ≤ 3			l/d = 3–4 (Schaftdurchmesser ≥ 25mm)		
Hartmetallschaft			l/d ≤ 5			l/d = 6–7		
Material	Härte	Schnittmodus	Schnittgeschw. (m/min)	Vorschub (mm/U.)	Schnitttiefe (mm)	Schnittgeschw. (m/min)	Vorschub (mm/U.)	Schnitttiefe (mm)
P C-Stahl Leg. Stahl	180–350HB	Leichtzerspanung	130 (90–160)	0.1 (0.05–0.15)	0.2	120 (80–150)	0.1 (0.05–0.15)	0.2
		Mittlere Zerspanung	90 (60–120)	0.25 (0.15–0.35)	–3.0	80 (50–110)	0.15 (0.1–0.2)	–1.5
M Rostfreier Stahl	≤200HB	Leichtzerspanung	140 (100–180)	0.1 (0.05–0.15)	0.2	140 (100–180)	0.1 (0.05–0.15)	0.2
		Mittlere Zerspanung	70 (50–90)	0.2 (0.15–0.25)	–2.0	60 (40–80)	0.15 (0.1–0.2)	–1.0
N Aluminiumlegierung	–	Leichtzerspanung	300 (200–400)	0.1 (0.05–0.15)	0.2	300 (200–400)	0.1 (0.05–0.15)	0.2
		Mittlere Zerspanung	200 (150–250)	0.1 (0.05–0.15)	–2.0	200 (150–250)	0.1 (0.05–0.15)	–1.5

DCWSP > A147–A152  
PCBN & PKD WSP > B054, B055, B068

ERSATZTEILE > N001  
TECHNISCHE DATEN > P001

# BOHRSTANGEN

## S BOHRSTANGEN

- Der kleinste Bearbeitungsdurchmesser ist  $\phi 20$ .
- ISO Standard.
- 7° positive WSP.
- Schraubklemmung.
- l/d ist 3 bis 5x Durchmesser (Hartmetallschaft ist 7-8x Durchmesser).

S		VC		WSP		Schichten		Schichten		Leicht		Leicht		
SVQC		VC		WSP		FP		FM		LP		LM		
						(11,16)		(11,16)		(11,16)		(11,16)		
						Mittel		Mittel		Mittel		Glatt		
						MP		MM		Standard				
						(16)		(16)		(11,16)		(11,16)		
Bestellbezeichnung	Lager		WSP Bezeichnung	Abmessungen (mm)								*		
	R	L		DCON	LF	LDRED	WF	WF2	H	GAMF	DMIN	Spannschraube	Schlüssel	
S16MSVQCR/L11	●	●	VCMW	1103	16	150	25	11	3.9	14	7°	20	TS25	TKY08F
S20QSVQCR/L11	●	●	VCMT	1103	20	180	32	13	4.4	18	7°	25	TS25	TKY08F
S25RSVQCR/L16	☆	●	VCGW	1604	25	200	40	17	6.9	23	5°	32	TS4	TKY15F
S32SSVQCR/L16	☆	●	VCGT	1604	32	250	50	22	8.4	30	5°	40	TS4	TKY15F
S40TSVQCR/L16	☆	●		1604	40	300	63	27	9.4	37	5°	50	TS4	TKY15F

\* Spannmoment (N • m) : TS25=1.0, TS4=3.5

BOHRSTANGEN

C		VC		Hartmetallschaft		WSP		Schichten		Schichten		Leicht		Leicht	
SVQC		VC		Hartmetallschaft		WSP		FP		FM		LP		LM	
						(11,16)		(11,16)		(11,16)		(11,16)			
						Mittel		Mittel		Mittel		Glatt			
						MP		MM		Standard					
						(16)		(16)		(11,16)		(11,16)			
Bestellbezeichnung	Lager		WSP Bezeichnung	Abmessungen (mm)								*			
	R	L		DCON	LF	LDRED	WF	WF2	H	GAMF	DMIN	Spannschraube	Schlüssel		
C16RSVQCR11	●		VCMW	1103	16	200	25	11	3.1	14	7°	20	TS25	TKY08F	
C20SSVQCR11	☆		VCMT	1103	20	250	32	13	3.1	18	7°	25	TS25	TKY08F	
C25TSVQCR16	☆		VCGW	1604	25	300	40	17	4.9	23	5°	32	TS4	TKY15F	

\* Spannmoment (N • m) : TS25=1.0, TS4=3.5

Hinweis 1) Die Fotos der Wendeschneidplatten dienen lediglich als Beispiel. Die Buchstaben beziehen sich auf den Spanbrecher und die Abmessungen auf den Innenkreisdurchmesser.

Hinweis 2) Die angegebenen Maße gelten für Wendeschneidplatten mit Eckenradius RE 0.4 (Artikel von ☆ beschriftet mit RE 0.8)

Hinweis 3) Bei der Verwendung von Wendeschneidplatten mit rechtsseitigem und linksseitigem Spanbrecher verwenden Sie bitte den linksseitigen Spanbrecher für den rechten Halter und den rechtsseitigen Spanbrecher für den linken Halter.

S O O SSKC			S C O O WSP								Schichten	Schichten	Leicht	Leicht
											FP	FM	LP	LM
											(09)	(09)	(09)	(09)
											Mittel	Mittel	Mittel	Glatt
											MP	MM	Standard	(09,12)
Bestellbezeichnung	Lager		WSP Bezeichnung		Abmessungen (mm)						*			
	R	L			DCON	LF	LDRED	WF	H	GAMF	DMIN	Spannschraube	Schlüssel	
S16MSSKCR/L09 ☆	●	●	SCMW SCMT	09T3	16	150	25	11	14	7°	20	TS4	TKY15F	
S20QSSKCR/L09 ☆	●	●		09T3	20	180	32	13	18	7°	25	TS4	TKY15F	
S25RSSKCR/L12 ☆	★	★		1204	25	200	40	17	23	5°	32	TS5	TKY25F	

\* Spannmoment (N • m) : TS4=3.5, TS5=7.5

S O O SVUC			V C O O WSP								Schichten	Schichten	Leicht	Leicht
											FP	FM	LP	LM
											(11,16)	(11,16)	(11,16)	(11,16)
											Mittel	Mittel	Mittel	Glatt
											MP	MM	Standard	(11,16)
Bestellbezeichnung	Lager		WSP Bezeichnung		Abmessungen (mm)						*			
	R	L			DCON	LF	LDRED	WF	WF2	H	GAMF	DMIN	Spannschraube	Schlüssel
S20QSVUCR/L11	●	●	VCMW VCMT VCGW VCGT	1103	20	180	32	13	4.4	18	7°	25	TS25	TKY08F
S25RSVUCR/L16 ☆	●	●		1604	25	200	40	17	6.9	23	5°	32	TS4	TKY15F
S32SSVUCR/L16 ☆	●	●		1604	32	250	50	22	8.4	30	5°	40	TS4	TKY15F
S40TSVUCR/L16 ☆	●	●		1604	40	300	63	27	9.4	37	5°	50	TS4	TKY15F

\* Spannmoment (N • m) : TS25=1.0, TS4=3.5

BOHRSTANGEN

## SCHNITTDATENEMPFEHLUNGEN

Stahlschaft			l/d ≤ 3			l/d = 3–4 (Schaftdurchmesser ≥ 25mm)		
Hartmetallschaft			l/d ≤ 5			l/d = 6–7		
Material	Härte	Schnittmodus	Schnittgeschw. (m/min)	Vorschub (mm/U.)	Schnitttiefe (mm)	Schnittgeschw. (m/min)	Vorschub (mm/U.)	Schnitttiefe (mm)
P C-Stahl Leg. Stahl	180–350HB	Leichtzerspanung	130 (90–160)	0.1 (0.05–0.15)	0.2	120 (80–150)	0.1 (0.05–0.15)	0.2
		Mittlere Zerspanung	90 (60–120)	0.25 (0.15–0.35)	–3.0	80 (50–110)	0.15 (0.1–0.2)	–1.5
M Rostfreier Stahl	≤200HB	Leichtzerspanung	140 (100–180)	0.1 (0.05–0.15)	0.2	140 (100–180)	0.1 (0.05–0.15)	0.2
		Mittlere Zerspanung	70 (50–90)	0.2 (0.15–0.25)	–2.0	60 (40–80)	0.15 (0.1–0.2)	–1.0
N Aluminiumlegierung	—	Leichtzerspanung	300 (200–400)	0.1 (0.05–0.15)	0.2	300 (200–400)	0.1 (0.05–0.15)	0.2
		Mittlere Zerspanung	200 (150–250)	0.1 (0.05–0.15)	–2.0	200 (150–250)	0.1 (0.05–0.15)	–1.5

S O O WSP > A155, A156  
 V C O O WSP > A167–A169  
 PCBN & PKD WSP > B060, B071

ERSATZTEILE > N001  
 TECHNISCHE DATEN > P001



# BOHRSTANGEN

## S BOHRSTANGEN

- Der kleinste Bearbeitungsdurchmesser ist  $\phi 20$ .
- $l/d$  ist 3 bis 5x Durchmesser.
- ISO Standard.
- 7° positive WSP.
- Schraubklemmung.

### S ○ ○ ○ SCZC

### CC ○ ○ WSP



Abb. zeigt Rechtsausführung.

Schichten	Schichten	Leicht	Leicht
FP (06,09)	FM (06,09)	LP (06,09)	LM (06,09)
Mittel	Mittel	Glatt	PCBN/PKD
MP (06,09)	MM (06,09)	(06,09)	(06,09)

Bestellbezeichnung	Lager		WSP Bezeichnung	Abmessungen (mm)									*	
	R	L		DCON	OAL	LF	WF	WF2	H	GAMF	DMIN	Spannschraube	Schlüssel	
<b>S16MSCZCR/L06</b>	●	●	CC ○ B CC ○ H CC ○ T CC ○ W	0602 ○ ○	16	161	150	11	3	14	10°	20	TS25	TKY08F
<b>S20QSCZCR/L09</b>	●	●		09T3 ○ ○	20	198	180	13	3	18	7°	25	TS4	TKY15F

Hinweis 1) Die Fotos der Wendeschneidplatten dienen lediglich als Beispiel Die Buchstaben beziehen sich auf den Spanbrecher und die Abmessungen auf den Innenkreisdurchmesser.

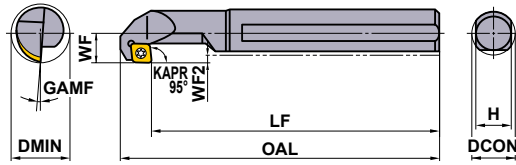
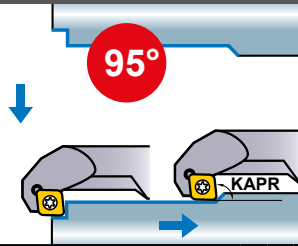
Hinweis 2) Bei Verwendung von WSP mit linken und rechten Spanbrechern. verwenden Sie bitte linke WSP mit linkem Halter und rechte WSP mit rechtem Halter.

\* Spannmoment (N • m) : TS25=1.0, TS4=3.5

E

BOHRSTANGEN

## SCHNITTDATENEMPFEHLUNGEN

Material	Härte	Schnittmodus	$l/d \leq 3$			$l/d = 3 - 4$ (Schaftdurchmesser $\geq 25$ mm)		
			Schnittgeschw. (m/min)	Vorschub (mm/U.)	Schnitttiefe (mm)	Schnittgeschw. (m/min)	Vorschub (mm/U.)	Schnitttiefe (mm)
P C-Stahl Leg. Stahl	180–350HB	Leichtzerspanung	130 (90–160)	0.1 (0.05–0.15)	0.2	120 (80–150)	0.1 (0.05–0.15)	0.2
		Mittlere Zerspanung	90 (60–120)	0.25 (0.15–0.35)	–3.0	80 (50–110)	0.15 (0.1–0.2)	–1.5
M Rostfreier Stahl	$\leq 200$ HB	Leichtzerspanung	140 (100–180)	0.1 (0.05–0.15)	0.2	140 (100–180)	0.1 (0.05–0.15)	0.2
		Mittlere Zerspanung	70 (50–90)	0.2 (0.15–0.25)	–2.0	60 (40–80)	0.15 (0.1–0.2)	–1.0
N Aluminiumlegierung	—	Leichtzerspanung	300 (200–400)	0.1 (0.05–0.15)	0.2	300 (200–400)	0.1 (0.05–0.15)	0.2
		Mittlere Zerspanung	200 (150–250)	0.1 (0.05–0.15)	–2.0	200 (150–250)	0.1 (0.05–0.15)	–1.5

● : Lagerstandard. ★ : Lagerstandard in Japan.

CC ○ ○ WSP

> A139–A145

PCBN & PKD WSP

> B051, B052, B067

# P BOHRSTANGEN

- Der kleinste Bearbeitungsdurchmesser ist  $\phi 25$ .
- ISO Standard.
- Wirtschaftlich negative WSP.
- Kniehebelklemmung.

A O O P S K N		Mit Kühlmittelbohrung		S N O W S P		Schichten	Leicht	Mittel	Mittel													
						FP	LP	MP	MH													
						(12)	(12)	(12)	(12)													
						Mittel	Rostfrei	G-Klasse	PCBN/PKD													
						Standard	MM	R/L														
						(09,12)	(12)	(09,12)	(12)													
Bestellbezeichnung	Lager		WSP Bezeichnung	Abmessungen (mm)									Werkzeuge									
	R	L		DCON	LF	LDRED	WF	H	GAMF	DMIN	Unterlegplatte	Befestigungsfeder	Kniehebel	Spannschraube	Schlüssel	Stopfen	Excenterstift	Stift	Schraube			
A20QPSKNR/L09	●	★	SNMA 0903	20	180	32	13	18	13°	25	—	—	—	—	HKY15R	HGM-PT1/8	HP3T	P208AM	HSS03005			
A25RPSKNR/L12	●	●	SNMG 1204	25	200	40	17	23	13°	32	MLSP42	—	—	—	HKY15R	HGM-PT1/4	HP43	P210AM	HSS03005			
A32SPSKNR/L12	●	●	SNGA 1204	32	250	50	22	30	13°	44	LLSN42	LLP14	LLCL14	LLCS108S	HKY30R	HGM-PT3/8	—	—	—			

\*1 Excenterspannung : A20QPSKNR/L09, A25RPSKNR/L12  
 \*2 Spannmoment (N · m) : LLCS108S=3.3, HP3T=2.2, HP43=3.3

A O O P T F N		Mit Kühlmittelbohrung		T N O W S P		Schichten	Leicht	Mittel	Mittel													
						FP	LP	MP	MH													
						(16)	(16,22)	(16,22)	(16,22)													
						Mittel	Rostfrei	G-Klasse	PCBN/PKD													
						Standard	MM	R/L														
						(16,22)	(16,22)	(16,22)	(16,22)													
Bestellbezeichnung	Lager		WSP Bezeichnung	Abmessungen (mm)									Werkzeuge									
	R	L		DCON	LF	LDRED	WF	H	GAMF	DMIN	Unterlegplatte	Befestigungsfeder	Kniehebel	Spannschraube	Schlüssel	Stopfen	Excenterstift	Stift	Schraube			
A20QPTFNR/L16	●	●	TNMA 1604	20	180	32	13	18	15°	25	—	—	—	—	HKY15R	HGM-PT1/8	HP31	P208AM	HSS03005			
A25RPTFNR/L16	●	●	TNMG 1604	25	200	40	17	23	13°	32	MLTP32	—	—	—	HKY15R	HGM-PT1/4	HP33	P208AM	HSS03005			
A32SPTFNR/L16	●	●	TNMM 1604	32	250	50	22	30	13°	44	LLSTN32	LLP13	LLCL13	LLCS106	HKY25R	HGM-PT3/8	—	—	—			
A40TPTFNR/L22	●	●	TNGG 2204	40	300	63	27	37	10°	54	LLSTN42	LLP14	LLCL14	LLCS108S	HKY30R	HGM-PT3/8	—	—	—			
A50UPTFNR/L22	●	●	TNGH 2204	50	350	80	35	47	9°	70	LLSTN42	LLP14	LLCL14	LLCS108S	HKY30R	HGM-PT3/8	—	—	—			

\*1 Excenterspannung : A20QPTFNR/L16, A25RPTFNR/L16  
 \*2 Spannmoment (N · m) : LLCS106=2.2, LLCS108S=3.3, HP31=2.2, HP33=2.2

## SCHNITTDATENEMPFEHLUNGEN

Material	Härte	Schnittmodus	l/d ≤ 3			l/d = 3 - 4		
			Schnittgeschw. (m/min)	Vorschub (mm/U.)	Schnitttiefe (mm)	Schnittgeschw. (m/min)	Vorschub (mm/U.)	Schnitttiefe (mm)
<b>P</b> C-Stahl Leg. Stahl	180–350HB	Mittlere Zerspanung	110 (80–140)	0.25 (0.1–0.4)	–5.0	110 (80–140)	0.2 (0.1–0.3)	–4.0
<b>M</b> Rostfreier Stahl	≤200HB	Mittlere Zerspanung	80 (60–100)	0.2 (0.1–0.3)	–4.0	70 (50–100)	0.15 (0.1–0.25)	–3.0
<b>K</b> Grauguss	Zugfestigkeit ≤350MPa	Mittlere Zerspanung	80 (60–100)	0.25 (0.1–0.4)	–5.0	80 (60–100)	0.2 (0.1–0.3)	–4.0

Hinweis 1) Die Fotos der Wendeschneidplatten dienen lediglich als Beispiel. Die Buchstaben beziehen sich auf den Spanbrecher und die Abmessungen auf den Innendurchmesser.  
 Hinweis 2) Die angegebenen Maße gelten für Wendeschneidplatten mit Eckenradius RE 0.4.  
 Hinweis 3) Bei der Verwendung von Wendeschneidplatten mit rechtsseitigem und linksseitigem Spanbrecher verwenden Sie bitte den linksseitigen Spanbrecher für den rechten Halter und den rechtsseitigen Spanbrecher für den linken Halter.

SN O W S P > A113–A118  
 TN O W S P > A119–A125  
 PCBN & PKD W S P > B043–B045, B065

ERSATZTEILE > N001  
 TECHNISCHE DATEN > P001



# BOHRSTANGEN

## P BOHRSTANGEN

- Der kleinste Bearbeitungsdurchmesser ist  $\phi 20$ . ● l/d ist 3x Durchmesser.
- ISO Standard.
- Wirtschaftlich negative WSP.
- Kniehebelklemmung.

A ○ ○ ○ PDUN

Mit Kühlmittelbohrung **DN ○ ○ WSP**

Schichten	Leicht	Mittel	Mittel
FP	LP	MP	MH
(15)	(11,15)	(15)	(15)
Mittel	Rostfrei	G-Klasse	PCBN/PKD
Standard	MM	R/L	
(11,15)	(15)	(15)	(15)

\*1 Excenterspannung Abb. zeigt Rechtsausführung.

Bestellbezeichnung	Lager		WSP Bezeichnung	Abmessungen (mm)									Werkzeuge									
	R	L		DCON	LF	LDRED	WF	WF2	H	GAMF	DMIN	Unterlegplatte	Befestigungsfeder	Kniehebel	Spannschraube	Schlüssel	Stopfen	Excenterstift	Stift	Schraube		
A20QPUNR/L11	●	●		1104	20	180	32	15	6.4	18	13°	26	—	—	LLCL23S	LLCS125	HKY20R	HGM-PT1/8	—	—	—	
A25RPUNR/L11	●	●	DNMA	1104	25	200	40	17	6.9	23	15°	32	LLSDN32	LLP13	LLCL23	LLCS106	HKY25R	HGM-PT1/4	—	—	—	
A25RPUNR/L15	●	●	DNMG	1504	25	200	40	17	6.9	23	13°	32	MLDP42	—	—	—	HKY15R HKY30R	HGM-PT1/4	HP43	P210AM	HSS03005	
A32SPUNR/L11	●	●	DNMX	1104	32	250	50	22	8.4	30	13°	44	LLSDN32	LLP13	LLCL23	LLCS106	HKY25R	HGM-PT3/8	—	—	—	
A32SPUNR/L15	●	●	DNMM	1504	32	250	50	22	8.4	30	13°	44	LLSDN42	LLP14	LLCL24	LLCS108S	HKY30R	HGM-PT3/8	—	—	—	
A40TPUNR/L15	●	●	DNGA	1504	40	300	63	27	9.4	37	10°	54	LLSDN42	LLP14	LLCL24	LLCS108S	HKY30R	HGM-PT3/8	—	—	—	
A50UPUNR/L15	●	●	DNGG	1504	50	350	80	35	12.4	47	9°	70	LLSDN42	LLP14	LLCL24	LLCS108S	HKY30R	HGM-PT3/8	—	—	—	

\*1 Excenterspannung : A25RPUNR/L15

\*2 Spannungmoment (N · m) : LLCS125=1.5, LLCS106=2.2, LLCS108S=3.3, HP43=3.3

A ○ ○ ○ PCLN

Mit Kühlmittelbohrung **CN ○ ○ WSP**

Schichten	Leicht	Leicht	Mittel
FP	SA	LP	MP
(12)	(12)	(12)	(12)
Mittel	Mittel	Rostfrei	PCBN/PKD
MH	Standard	MM	
(12)	(09,12)	(12)	(12)

\*1 Excenterspannung Abb. zeigt Rechtsausführung.

Bestellbezeichnung	Lager		WSP Bezeichnung	Abmessungen (mm)									Werkzeuge									
	R	L		DCON	LF	LDRED	WF	H	GAMF	DMIN	Unterlegplatte	Befestigungsfeder	Kniehebel	Spannschraube	Schlüssel	Stopfen	Excenterstift	Stift	Schraube			
A16MPCLNR/L09	●	●		09T3	16	150	25	11	14	15°	20	—	—	LLCL13S	LLCS105	HKY20R	HGM-PT1/8	—	—	—		
A20QPCLNR/L09	●	●		09T3	20	180	32	13	18	13°	25	—	—	—	—	HKY25R HKY15R	HGM-PT1/8	HP3T	P208AM	HSS03005		
A20QPCLNR/L09N	●	★	CNMA	09T3	20	180	32	13	18	13°	25	—	—	LLCL13S	LLCS105	HKY20R	HGM-PT1/8	—	—	—		
A25RPCLNR/L09	●	★	CNMG	09T3	25	200	40	17	23	13°	32	—	—	LLCL13S	LLCS105	HKY20R	HGM-PT1/4	—	—	—		
A25RPCLNR/L12	●	●	CNMM	09T3	25	200	40	17	23	13°	32	MLCP42	—	—	—	HKY30R HKY15R	HGM-PT1/4	HP43	P210AM	HSS03005		
A32SPCLNR/L12	●	●	CNGA	1204	32	250	50	22	30	13°	44	LLSCN42	LLP14	LLCL14	LLCS108S	HKY30R	HGM-PT3/8	—	—	—		
A40TPCLNR/L12	●	●	CNGG	1204	40	300	63	27	37	10°	54	LLSCN42	LLP14	LLCL14	LLCS108S	HKY30R	HGM-PT3/8	—	—	—		
A50UPCLNR12	●	●	CNGM	1204	50	350	80	35	47	10°	63	LLSCP42	LLP14	LLCL14	LLCS108S	HKY30R	HGM-PT3/8	—	—	—		

\*1 Excenterspannung : A20QPCLNR/L09, A25RPCLNR/L12

\*2 Spannungmoment (N · m) : LLCS105=1.5, LLCS106=2.2, LLCS108S=3.3, HP3T=2.2, HP43=3.3

\*3 Erwägen Sie bei einem Austausch des Ersatzteils LLCL13S gegebenenfalls das Ersatzteil HLS2 dazu erwerben.

Hinweis 1) Die Fotos der Wendeschneidplatten dienen lediglich als Beispiel. Die Buchstaben beziehen sich auf den Spanbrecher und die Abmessungen auf den Innenkreisdurchmesser.

Hinweis 2) Die angegebenen Maße gelten für Wendeschneidplatten mit Eckenradius RE 0.4.

Hinweis 3) Bei der Verwendung von Wendeschneidplatten mit rechtsseitigem und linksseitigem Spanbrecher verwenden Sie bitte den linksseitigen Spanbrecher für den rechten Halter und den rechtsseitigen Spanbrecher für den linken Halter.

● : Lagerstandard. ★ : Lagerstandard in Japan.

DN ○ ○ WSP	> A105 – A111
CN ○ ○ WSP	> A098 – A104, A136
PCBN & PKD WSP	> B036 – B042, B064

A○○○PWLN		Mit Kühlmittelbohrung								WN○○WSP		Leicht	Mittel		
		Lager		WSP Bezeichnung		Abmessungen (mm)						*2		*1	
						DCON	LF	LDRED	WF	H	GAMF	DMIN	Kniehebel	Spannschraube	Schlüssel
Bestellbezeichnung	R	L													
A16MPWLN/L06	●	●	WNMG	06T3○○	16	150	25	11	14	15°	20	LLCL13S	LLCS105	HKY20R	HGM-PT1/8
A20QPWLN/L06	●	●		06T3○○	20	180	32	13	18	13°	25	LLCL13S	LLCS105	HKY20R	HGM-PT1/8
A25RPWLN/L06	●	●		06T3○○	25	200	40	17	23	13°	32	LLCL13S	LLCS105	HKY20R	HGM-PT1/4

\*1 Spannmoment (N • m) : LLCS105=1.5

\*2 Erwägen Sie bei einem Austausch des Klemmhebels LLCL13S gegebenenfalls die Hebelfeder HLS2 mit zu erwerben.

A○○○PDQN		Mit Kühlmittelbohrung								DN○○WSP		Schichten	Leicht	Mittel	Mittel						
		Lager		WSP Bezeichnung		Abmessungen (mm)						*2		*1		*2					
						DCON	LF	LDRED	WF	WF2	H	GAMF	DMIN	Unterlegplatte	Befestigungsfeder	Kniehebel	Spannschraube	Schlüssel	Stopfen	Excenterstift	Stift
Bestellbezeichnung	R	L																			
A25RPDQNR/L15	●	●	DNMA	1504○○	25	200	40	17	6.9	23	13°	32	MLDP42	—	—	—	HKY15R	HGM-PT1/4	HP43	P210AM	HSS03005
A32SPDQNR/L15	●	●	DNMG	1504○○	32	250	50	22	8.4	30	13°	44	LLSDN42	LLP14	LLCL24	LLCS108S	HKY30R	HGM-PT3/8	—	—	—
A40TPDQNR/L15	●	●	DNGA	1504○○	40	300	63	27	9.4	37	10°	54	LLSDN42	LLP14	LLCL24	LLCS108S	HKY30R	HGM-PT3/8	—	—	—
A50UPDQNR/L15	★		DNGM	1504○○	50	350	80	35	12.4	47	9°	70	LLSDN42	LLP14	LLCL24	LLCS108S	HKY30R	HGM-PT3/8	—	—	—

\*1 Excenterspannung : A25RPDQNR/L15

\*2 Spannmoment (N • m) : LLCS108S=3.3, HP43=3.3

## SCHNITTDATENEMPFEHLUNGEN

Material	Härte	Schnittmodus	l/d ≤ 3			l/d = 3 - 4		
			Schnittgeschw. (m/min)	Vorschub (mm/U.)	Schnitttiefe (mm)	Schnittgeschw. (m/min)	Vorschub (mm/U.)	Schnitttiefe (mm)
<b>P</b> C-Stahl Leg. Stahl	180—350HB	Mittlere Zerspanung	110 (80—140)	0.25 (0.1—0.4)	—5.0	110 (80—140)	0.2 (0.1—0.3)	—4.0
<b>M</b> Rostfreier Stahl	≤200HB	Mittlere Zerspanung	80 (60—100)	0.2 (0.1—0.3)	—4.0	70 (50—100)	0.15 (0.1—0.25)	—3.0
<b>K</b> Grauguss	Zugfestigkeit ≤350MPa	Mittlere Zerspanung	80 (60—100)	0.25 (0.1—0.4)	—5.0	80 (60—100)	0.2 (0.1—0.3)	—4.0

WN○○WSP	> A130—A133
DN○○WSP	> A105—A111
PCBN & PKD WSP	> B039—B042, B064

ERSATZTEILE	> N001
TECHNISCHE DATEN	> P001

# BOHRSTANGEN

## P BOHRSTANGEN

- Der kleinste Bearbeitungsdurchmesser ist  $\phi 32$ .
- ISO Standard.
- Wirtschaftlich negative WSP.
- Kniehebelklemmung.

### A O O PDZN

Mit Kühlmittelbohrung

### DN O WSP

Schichten

FP

(15)

Mittel

Standard

(15)

Leicht

LP

(15)

Rostfrei

MM

(15)

Mittel

MP

(15)

G-Klasse

R/L

(15)

Mittel

MH

(15)

PCBN/PKD

(15)

\*1 Excenterspannung Abb. zeigt Rechtsausführung.

Bestellbezeichnung	Lager		WSP Bezeichnung	Abmessungen (mm)										Zubehör									
	R	L		DCON	OAL	LF	WF	WF2	H	GAMF	DMIN	Unterlegplatte	Befestigungsfeder	Kniehebel	Spannschraube	Schlüssel	Stopfen	Excenterstift	Stift	Schraube			
<b>A25RPDZNR/L15</b>	●	●	DNMA	1504	25	225	200	17	6.7	23	13°	32	MLDP42	—	—	—	HKY15R HKY30R	HGM-PT1/4	HP43	P210AM	HSS03005		
<b>A32SPDZNR/L15</b>	●	●	DNMG	1504	32	275	250	22	8.2	30	13°	40	LLSDN42	LLP14	LLCL24	LLCS108S	HKY30R	HGM-PT3/8	—	—	—		
<b>A40TPDZNR/L15</b>	●	●	DNMX	1504	40	325	300	27	9.2	37	10°	50	LLSDN42	LLP14	LLCL24	LLCS108S	HKY30R	HGM-PT3/8	—	—	—		
<b>A50UPDZNR/L15</b>	●	●	DNMM	1504	50	375	350	35	12.2	47	9°	63	LLSDN42	LLP14	LLCL24	LLCS108S	HKY30R	HGM-PT3/8	—	—	—		

\*1 Excenterspannung

\*2 Spannungmoment (N · m) : LLCS108S=3.3, HP43=3.3

Hinweis 1) Die Fotos der Wendeschneidplatten dienen lediglich als Beispiel. Die Buchstaben beziehen sich auf den Spanbrecher und die Abmessungen auf den Innendurchmesser.

Hinweis 2) Die angegebenen Maße gelten für Wendeschneidplatten mit Eckenradius 0.8.

Hinweis 3) Bei Verwendung von WSP mit linken und rechten Spanbrechern verwenden Sie bitte linke WSP mit linkem Halter und rechte WSP mit rechtem Halter.

BOHRSTANGEN

## SCHNITTDATENEMPFEHLUNGEN

Material	Härte	Schnittmodus	l/d ≤ 3			l/d = 3–4		
			Schnittgeschw. (m/min)	Vorschub (mm/U.)	Schnitttiefe (mm)	Schnittgeschw. (m/min)	Vorschub (mm/U.)	Schnitttiefe (mm)
<b>P</b> C-Stahl Leg. Stahl	180–350HB	Mittlere Zerspanung	110 (80–140)	0.25 (0.1–0.4)	–5.0	110 (80–140)	0.2 (0.1–0.3)	–4.0
<b>M</b> Rostfreier Stahl	≤200HB	Mittlere Zerspanung	80 (60–100)	0.2 (0.1–0.3)	–4.0	70 (50–100)	0.15 (0.1–0.25)	–3.0
<b>K</b> Grauguss	Zugfestigkeit ≤350MPa	Mittlere Zerspanung	80 (60–100)	0.25 (0.1–0.4)	–5.0	80 (60–100)	0.2 (0.1–0.3)	–4.0

● : Lagerstandard. ★ : Lagerstandard in Japan.

DN O WSP

➤ A105–A111

PCBN & PKD WSP

➤ B039–B042, B064

# AL BOHRSTANGEN

- Geeignet für Nichteisenmetall.
- 20° positive WSP.
- Schraubklemmung.
- l/d ist 6x Durchmesser.
- Sehr guter Vibrationswiderstand.
- Der kleinste Bearbeitungsdurchmesser ist  $\phi 20$ .

## SSTFE

## TEWSP

Mittel	PKD
R/L  (16)	R/L  (16)
PKD  (16)	





Abb. zeigt Rechtsausführung.

Bestellbezeichnung	Lager		WSP Bezeichnung	Abmessungen (mm)						*  		
	R	L		DCON	LF	LDRED	WF	H	DMIN	Spanschraube	Schlüssel	
<b>S16RSTFER/L16</b>	★	★	TEGX	1603	16	200	30	11	14.6	<b>20</b>	FC400890T	TKY10F
<b>S20RSTFER/L16</b>	★	★		1603	20	200	37	13	18	<b>25</b>	FC400890T	TKY10F
<b>S25SSTFER/L16</b>	★	★		1603	25	250	40	17	23	<b>32</b>	FC400890T	TKY10F

\* Spannmoment (N • m) : FC400890T=2.5

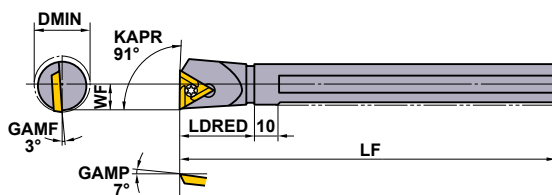
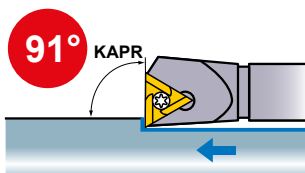
Hinweis 1) Die Fotos der Wendeschneidplatten dienen lediglich als Beispiel. Die Buchstaben beziehen sich auf den Spanbrecher und die Abmessungen auf den Innenkreisdurchmesser.

Hinweis 2) Die angegebenen Maße gelten für Wendeschneidplatten mit Eckenradius RE 0.4

Hinweis 3) Bei der Verwendung von Wendeschneidplatten mit rechtsseitigem und linksseitigem Spanbrecher verwenden Sie bitte den linksseitigen Spanbrecher für den rechten Halter und den rechtsseitigen Spanbrecher für den linken Halter.

E

BOHRSTANGEN

## SCHNITTDATENEMPFEHLUNGEN

Material	Sorte	Schnittgeschw. (m/min)	l/d=3		l/d=4		l/d=5		l/d=6	
			Vorschub (mm/U.)	Schnitttiefe (mm)	Vorschub (mm/U.)	Schnitttiefe (mm)	Vorschub (mm/U.)	Schnitttiefe (mm)	Vorschub (mm/U.)	Schnitttiefe (mm)
N Aluminiumlegierung	HTi10	400 (200–600)	0.15 (0.05–0.25)	–3.0	0.15 (0.05–0.25)	–3.0	0.1 (0.05–0.2)	–2.5	0.1 (0.05–0.2)	–1.0
	MD220	800 (200–1500)	0.15 (0.05–0.25)	–3.0	0.15 (0.05–0.25)	–3.0	0.1 (0.05–0.2)	–2.5	0.1 (0.05–0.2)	–1.0

TEWSP > A161  
 PKD WSP > B073  
 ERSATZTEILE > N001  
 TECHNISCHE DATEN > P001

E041

# Notizen

---

A series of horizontal dashed lines for taking notes, spanning the width of the page.

# Notizen

---

A series of horizontal dashed lines for writing notes, spanning the width of the page.

# ALLGEMEINE ERKLÄRUNG: DREHWERKZEUGE EINSTECHEN UND ABSTECHEN

## ● Wie sind die Seiten dieses Kapitels aufgebaut

1. Aufgelistet nach externer und interner Anwendung.
2. Untergruppen aufgeteilt nach Produkt-Serien.  
(Beachten Sie das Inhaltsverzeichnis auf der nächsten Seite.)

### ABBILDUNG ZEIGT ANWENDUNGSBEREICH

Die Abbildung und Bearbeitungspfeile beschreiben die möglichen Bearbeitungsarten wie Ab-, Einstechen und Kopieren.

### HINWEIS AUF HALTERAUSFÜHRUNG

Weist auf den Anwendungsbereich des Halters hin.

### PRODUKTNAME

### PRODUKT KAPITEL

### AUSSEN- ODER INNENBEARBEITUNG

### ABBILDUNG

### ERSATZTEILE FÜR HALTER

**1 00° Ausführung**

Bemerkung 1) Modulare Schwenker und modulare Halter bitte separat bestellen.  
Bemerkung 2) Bitte Modell in Rechtsaußführung für den Halter in Rechtsaußführung und in Linksaußführung für den Halter in Linksaußführung verwenden.

**ERSATZTEILE**

Halter	Spannschraube (Spannmoment: 1,0 N·m)	Schraube in Stear	Schlossel*
GYRL0000000000	HSC05020	—	HKY40R
GYRL0000000000	TS407	Spannmoment: 3,5 N·m	QTKY30R QTKY150
GYRL0000000000	GY06013M	Spannmoment: 6,0 N·m	—
GYRL0000000000	TS565	Spannmoment: 5,0 N·m	QTKY30R QTKY250

Sitegröße	Abmessungen (mm)				Typ	Halter (rechts)	Bestellbezeichnung			Bild	Abmessungen (mm) #3								Schnittmodus	WSP-Auswahl
	CW	CDX	CUTDIA	LH			Halter	Agner	Modulares Schwert		Lager	H	B	LF	LH	LH2	HF	WF		
D 2.00 2.24	6	12	Modular	R	GYHR1616J00-M20R	GYM20RA-D06	3	16	16	104	28	44	16	20	4	R	Gegen Uhrzeiger	* Standard-WSP mit Abmessungen SPS: 100, 150, 200, 250, 300, 350, 400, 450, 500, 550, 600, 650, 700, 750, 800, 850, 900, 950, 1000 CW: 1, 2, 3, 4, 5, 6, 7, 8, 9, 10, 11, 12, 13, 14, 15, 16, 17, 18, 19, 20, 21, 22, 23, 24, 25, 26, 27, 28, 29, 30, 31, 32, 33, 34, 35, 36, 37, 38, 39, 40, 41, 42, 43, 44, 45, 46, 47, 48, 49, 50, 51, 52, 53, 54, 55, 56, 57, 58, 59, 60, 61, 62, 63, 64, 65, 66, 67, 68, 69, 70, 71, 72, 73, 74, 75, 76, 77, 78, 79, 80, 81, 82, 83, 84, 85, 86, 87, 88, 89, 90, 91, 92, 93, 94, 95, 96, 97, 98, 99, 100 D: 2, 2.20mm		
				L	GYHL1616J00-M20L	GYM20LA-D06	3	16	16	104	28	44	16	20	4					
				R	GYHR2020K00-D06	GYM20RA-D06	7	20	20	125	36	—	20	20	15				—	
				L	GYHL2020K00-D06	GYM20LA-D06	7	20	20	125	36	—	20	20	15				—	
				R	GYHR2020K00-M20R	GYM20RA-D06	1	20	20	119	28	43	20	23	—				—	
				L	GYHL2020K00-M20L	GYM20LA-D06	1	20	20	119	28	43	20	23	—				—	
	10	20	Modular	R	GYHR2225M00-M25R	GYM25RA-D06	1	25	25	142	31	49	25	28	—	L	Gegen Uhrzeiger	* Standard-WSP mit Abmessungen SPS: 100, 150, 200, 250, 300, 350, 400, 450, 500, 550, 600, 650, 700, 750, 800, 850, 900, 950, 1000 CW: 1, 2, 3, 4, 5, 6, 7, 8, 9, 10, 11, 12, 13, 14, 15, 16, 17, 18, 19, 20, 21, 22, 23, 24, 25, 26, 27, 28, 29, 30, 31, 32, 33, 34, 35, 36, 37, 38, 39, 40, 41, 42, 43, 44, 45, 46, 47, 48, 49, 50, 51, 52, 53, 54, 55, 56, 57, 58, 59, 60, 61, 62, 63, 64, 65, 66, 67, 68, 69, 70, 71, 72, 73, 74, 75, 76, 77, 78, 79, 80, 81, 82, 83, 84, 85, 86, 87, 88, 89, 90, 91, 92, 93, 94, 95, 96, 97, 98, 99, 100 D: 2, 2.20mm		
				L	GYHL2225M00-M25L	GYM25LA-D06	1	25	25	142	31	49	25	28	—					
				R	GYHR3225P00-M25R	GYM25RA-D06	5	32	32	162	31	49	32	28	—					
				L	GYHL3225P00-M25L	GYM25LA-D06	5	32	32	162	31	49	32	28	—					
				R	GYHR3225P00-M25R	GYM25RA-D06	5	32	32	162	31	49	32	35	—					
				L	GYHL3225P00-M25L	GYM25LA-D06	5	32	32	162	31	49	32	35	—					
18 *4	36	Modular	R	GYHR1616J00-M20R	GYM20RA-D10	3	16	16	110	34	50	16	20	4	R	Gegen Uhrzeiger	* Standard-WSP mit Abmessungen SPS: 100, 150, 200, 250, 300, 350, 400, 450, 500, 550, 600, 650, 700, 750, 800, 850, 900, 950, 1000 CW: 1, 2, 3, 4, 5, 6, 7, 8, 9, 10, 11, 12, 13, 14, 15, 16, 17, 18, 19, 20, 21, 22, 23, 24, 25, 26, 27, 28, 29, 30, 31, 32, 33, 34, 35, 36, 37, 38, 39, 40, 41, 42, 43, 44, 45, 46, 47, 48, 49, 50, 51, 52, 53, 54, 55, 56, 57, 58, 59, 60, 61, 62, 63, 64, 65, 66, 67, 68, 69, 70, 71, 72, 73, 74, 75, 76, 77, 78, 79, 80, 81, 82, 83, 84, 85, 86, 87, 88, 89, 90, 91, 92, 93, 94, 95, 96, 97, 98, 99, 100 D: 2, 2.20mm			
			L	GYHL1616J00-M20L	GYM20LA-D10	3	16	16	110	34	50	16	20	4						
			R	GYHR2020K00-M20R	GYM20RA-D10	1	20	20	125	34	49	20	23	—						
			L	GYHL2020K00-M20L	GYM20LA-D10	1	20	20	125	34	49	20	23	—						
			R	GYHR2020K00-M25R	GYM25RA-D12	3	20	20	125	39	60	20	26	5						
			L	GYHL2020K00-M25L	GYM25LA-D12	3	20	20	125	39	60	20	26	5						
20 *1	40 *2	Modular	R	GYHR2225M00-M25R	GYM25RA-D12	1	25	25	150	39	57	25	28	—	L	Gegen Uhrzeiger	* Standard-WSP mit Abmessungen SPS: 100, 150, 200, 250, 300, 350, 400, 450, 500, 550, 600, 650, 700, 750, 800, 850, 900, 950, 1000 CW: 1, 2, 3, 4, 5, 6, 7, 8, 9, 10, 11, 12, 13, 14, 15, 16, 17, 18, 19, 20, 21, 22, 23, 24, 25, 26, 27, 28, 29, 30, 31, 32, 33, 34, 35, 36, 37, 38, 39, 40, 41, 42, 43, 44, 45, 46, 47, 48, 49, 50, 51, 52, 53, 54, 55, 56, 57, 58, 59, 60, 61, 62, 63, 64, 65, 66, 67, 68, 69, 70, 71, 72, 73, 74, 75, 76, 77, 78, 79, 80, 81, 82, 83, 84, 85, 86, 87, 88, 89, 90, 91, 92, 93, 94, 95, 96, 97, 98, 99, 100 D: 2, 2.20mm			
			L	GYHL2225M00-M25L	GYM25LA-D12	1	25	25	150	39	57	25	28	—						
			R	GYHR3225P00-M25R	GYM25RA-D12	5	32	32	170	39	57	32	28	—						
			L	GYHL3225P00-M25L	GYM25LA-D12	5	32	32	170	39	57	32	28	—						
			R	GYHR3225P00-M25R	GYM25RA-D12	5	32	32	170	39	57	32	35	—						
			L	GYHL3225P00-M25L	GYM25LA-D12	5	32	32	170	39	57	32	35	—						
20 *1	40 *2	Modular	R	GYHR1616J00-M20R	GYM20RA-D18	4	16	16	116	40	56	16	20	4	R	Gegen Uhrzeiger	* Standard-WSP mit Abmessungen SPS: 100, 150, 200, 250, 300, 350, 400, 450, 500, 550, 600, 650, 700, 750, 800, 850, 900, 950, 1000 CW: 1, 2, 3, 4, 5, 6, 7, 8, 9, 10, 11, 12, 13, 14, 15, 16, 17, 18, 19, 20, 21, 22, 23, 24, 25, 26, 27, 28, 29, 30, 31, 32, 33, 34, 35, 36, 37, 38, 39, 40, 41, 42, 43, 44, 45, 46, 47, 48, 49, 50, 51, 52, 53, 54, 55, 56, 57, 58, 59, 60, 61, 62, 63, 64, 65, 66, 67, 68, 69, 70, 71, 72, 73, 74, 75, 76, 77, 78, 79, 80, 81, 82, 83, 84, 85, 86, 87, 88, 89, 90, 91, 92, 93, 94, 95, 96, 97, 98, 99, 100 D: 2, 2.20mm			
			L	GYHL1616J00-M20L	GYM20LA-D18	4	16	16	116	40	56	16	20	4						
			R	GYHR2020K00-M20R	GYM20RA-D18	2	20	20	131	40	55	20	23	—						
			L	GYHL2020K00-M20L	GYM20LA-D18	2	20	20	131	40	55	20	23	—						
			R	GYHR2020K00-M25R	GYM25RA-D20	4	20	20	131	45	66	20	26	5						
			L	GYHL2020K00-M25L	GYM25LA-D20	4	20	20	131	45	66	20	26	5						
20 *1	40 *2	Modular	R	GYHR2225M00-D20	GYM25RA-D20	7	25	25	150	41	—	25	25	1	L	Gegen Uhrzeiger	* Standard-WSP mit Abmessungen SPS: 100, 150, 200, 250, 300, 350, 400, 450, 500, 550, 600, 650, 700, 750, 800, 850, 900, 950, 1000 CW: 1, 2, 3, 4, 5, 6, 7, 8, 9, 10, 11, 12, 13, 14, 15, 16, 17, 18, 19, 20, 21, 22, 23, 24, 25, 26, 27, 28, 29, 30, 31, 32, 33, 34, 35, 36, 37, 38, 39, 40, 41, 42, 43, 44, 45, 46, 47, 48, 49, 50, 51, 52, 53, 54, 55, 56, 57, 58, 59, 60, 61, 62, 63, 64, 65, 66, 67, 68, 69, 70, 71, 72, 73, 74, 75, 76, 77, 78, 79, 80, 81, 82, 83, 84, 85, 86, 87, 88, 89, 90, 91, 92, 93, 94, 95, 96, 97, 98, 99, 100 D: 2, 2.20mm			
			L	GYHL2225M00-D20	GYM25LA-D20	7	25	25	150	41	—	25	25	1						
			R	GYHR2225M00-M25R	GYM25RA-D20	2	25	25	156	45	63	25	28	—						
			L	GYHL2225M00-M25L	GYM25LA-D20	2	25	25	156	45	63	25	28	—						
			R	GYHR3225P00-M25R	GYM25RA-D20	6	32	32	176	45	63	32	28	—						
			L	GYHL3225P00-M25L	GYM25LA-D20	6	32	32	176	45	63	32	28	—						

**LEGENDE FÜR LAGERSTATUS**  
Wird auf jeder Doppelseite auf der linken Seite gezeigt.

**STANDARDPRODUKTE**  
Listet Bestellbezeichnung, Lagerstatus Rechts/Links, Halter, modulares Schwert, Stechbreite, max. Stechtiefe, max. Abstechdurchmesser, Abmessungen, verfügbare WSP und Schneidkantenformen auf.

**QUERVERWEIS AUF ANDERE SEITEN**  
 • SICHERHEITSHINWEISE  
 • SCHNITTBEDINGUNGEN  
 • IDENTIFIKATION  
 Wird als Querverweis auf der rechten Seite einer jeden Doppelseite angezeigt.



# DREHWERKZEUGE

# EINSTECHEN UND ABSTECHEN

KLASSIFIKATION (AUSSEN) ..... F002

KLASSIFIKATION (INNEN) ..... F003

## STANDARDWERKZEUGE FÜR DAS EINSTECHEN UND ABSTECHEN

### AUSSEN

EIGENSCHAFTEN DER GY-SERIE ..... F004

BESTELLBEZEICHNUNG SERIE GY ..... F008

WENDESCHNEIDPLATTEN DER GY-SERIE ..... F012

REFERENZDATEN SERIE GY ..... F016

GY-SERIE ..... F018

GW-SERIE ..... F114

MG-HALTER ..... F124

### INNEN

GY-SERIE ..... F082

MICRO-MINI BOHRSTANGEN ..... F126

MICRO-MINI TWIN BOHRSTANGEN ..... F127



\*In alphabetischer Reihenfolge

F126 COOR-BLS

F127 CG

F120 GW1

F118 GWB

F119 GWTB

F012 GY

F124 MGH

F125 MGT

F129 RBH

F130 SBH







# KLASSIFIKATION

## AUSSENBEARBEITUNG

Halterbezeichnung	WSP-Form	Eigenschaften	Mögliche Stechbreite entsprechend der Anwendungsmethode (mm)					
			Normale Einstiche	Tiefe Einstiche	Abstechen	Kopieren	Freistechen	Avaleinstechen
<b>GY Serie</b>   F018	<ul style="list-style-type: none"> <li>Typ des modularen Schwertes</li> <li>Spannfingerklemmung.</li> <li>Das modulare Schwert gewährleistet eine sehr hohe Stabilität und Präzision. (Triforce-System)</li> <li>Großes WSP-Angebot.</li> </ul> Monoblockhalter <ul style="list-style-type: none"> <li>Federklemmung.</li> <li>Max. Abstechedurchmesser 50mm.</li> </ul>	1.5 2 2.24 2.39 2.5 2.74 3 3.18 3.24 4 4.24 4.75 5 5.24 6 6.31 6.35 8	1.5 2 2.24 2.39 2.5 2.74 3 3.18 3.24 4 4.24 4.75 5 5.24 6 6.31 6.35 8	1.5 2 2.24 2.39 2.5 2.74 3 3.18 3.24 4 4.24 4.75 5 5.24 6 6.31 6.35 8	2 2.5 3 3.18 4 4.75 5 6 6.35 8	2 2.5 3 3.18 4 4.75 5 6 6.35 8	2 2.24 2.39 2.5 2.74 3 3.18 3.24 4 4.24 4.75 5 5.24 6 6.31 6.35	
<b>GW Serie</b>   F118	<ul style="list-style-type: none"> <li>Typ Federklemme.</li> <li>Einfache WSP-Klemmmethode</li> <li>Das Stechschwert kann mit externer als auch interner Kühlmittelzufuhr eingesetzt werden.</li> <li>Spanbrecher mit ausgezeichneten Spanabfuhereigenschaften.</li> <li>Maximaler Abstechedurchmesser: 120 mm.</li> </ul>	2.0 3.0 4.0 5.0	2.0 3.0 4.0 5.0	2.0 3.0 4.0 5.0				
<b>MG Halter</b>   F124	<ul style="list-style-type: none"> <li>Spannfingerklemmung.</li> <li>Präzisions-WSP.</li> <li>Positiver Schnitt für beste Schlichtoberfläche.</li> </ul>	1.25   6						
SMALL TOOLS	<b>GTAH GTBH GTCH</b>   D018	<ul style="list-style-type: none"> <li>Für Längsdrehautomaten mit Linearschlitten.</li> <li>Kleine Schaftgrößen : 8mm—16mm.</li> <li>Spezielle Klemmschraube für hohe Stabilität.</li> <li>WSP kann direkt in der Maschine gewechselt werden.</li> <li>Wirtschaftliche WSP dank 3-Schneiden-Ausführung.</li> </ul>	0.3   3.0					
	<b>CTAH</b>   D020	<ul style="list-style-type: none"> <li>Für Längsdrehautomaten mit Linearschlitten.</li> <li>Kleine Schaftgrößen : 8mm—16mm.</li> <li>Werkzeughalter in Rechts und Linksausführung lieferbar.</li> <li>WSP kann direkt in der Maschine gewechselt werden.</li> <li>Max. Abstechedurchmesser ist 12mm.</li> </ul>	0.7 1.0 1.5 2.0	0.7 1.0 1.5 2.0	0.7 1.0 1.5 2.0			
	<b>CTBH</b>   D015	<ul style="list-style-type: none"> <li>Für Längsdrehautomaten mit Linearschlitten.</li> <li>Kleine Schaftgrößen : 10mm—16mm.</li> <li>Ein Halter für Hinterdrehen und Abstechen.</li> <li>WSP kann direkt in der Maschine gewechselt werden.</li> <li>Max. Abstechedurchmesser ist 16mm.</li> </ul>	1.5 2.0	1.5 2.0	1.5 2.0			

EINSTECHEN / ABSTECHEN

## INNENBEARBEITUNG

Halterbezeichnung	WSP-Form	Eigenschaften	Min. Durchmesser (mm)	Stechbreite (mm)	Max. Stechtiefe (mm)
<b>MICRO-MINI TWIN Bohrstangen</b>   F127	—	<ul style="list-style-type: none"> <li>● Hartmetallausführung.</li> <li>● Hohe Wirtschaftlichkeit aufgrund der 2 Schneidkanten.</li> </ul>	3.0	1.0   2.0	1.0   2.0
<b>MICRO-MINI Bohrstangen</b>   F126	—	<ul style="list-style-type: none"> <li>● Hartmetallausführung.</li> <li>● Für einen größeren Anwendungsbereich kann die WSP geschliffen werden.</li> </ul>	3.2	2.0   3.0	1.0   2.0
<b>GY Serie</b>   F082		Typ des modularen Schwertes <ul style="list-style-type: none"> <li>● Spannfingerklemmung.</li> <li>● Das modulare Schwert gewährleistet eine sehr hohe Stabilität und Präzision. (Triforce-System)</li> <li>● Großes WSP-Angebot.</li> </ul> Monoblockhalter <ul style="list-style-type: none"> <li>● Federklemmung.</li> </ul>	25	2   6.35	4   13



# GY SERIE

## Eine große Auswahl an Haltern und WSP für verschiedene Ein- und Abstechanwendungen.

### Aussen • Axial Stechhalter

Eine Vielzahl an Schwertern und Haltern mit unterschiedlichen Schaftgrößen möglich.

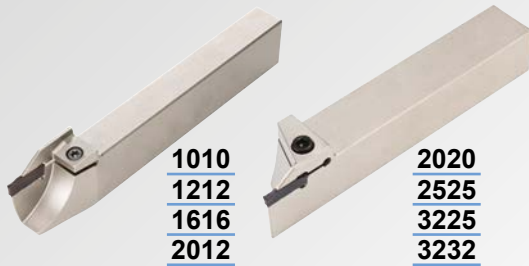

**Monoblock Ausführung**



**Modulare Ausführung**

EINSTECHEN / ABSTECHEN

In einer Vielzahl an Ausführungen für unterschiedlichste axiale Stechtiefen und Durchmesser lieferbar.



Verschiedene Haltergrößen für entsprechende modulare Schwerter.



### Inneneinstechhalter

Große Auswahl an Haltern ab einem Bearbeitungsdurchmesser von  $\varnothing 25\text{mm}$  lieferbar.

**Monoblock Ausführung**

Min. Durchmesser  $\varnothing 25, \varnothing 32$



**Modulare Ausführung**

Min. Durchmesser  $\varnothing 40, \varnothing 50, \varnothing 60, \varnothing 70$

Kurze Schaftausführung als Lagerstandard lieferbar.

**Monoblock Ausführung**

**Modulare Ausführung**



**Kurz**

**Standard**

**Kurz**

**Standard**

# Innovatives WSP-Design. Wegweisend für alle Ein- und Abstechanwendungen

## Außerordentlich zuverlässige WSP-Klemmung

Sicherheitskeile verhindern ein Verschieben der WSP.

Konvexe Geometrie für eine besonders präzise Klemmung.

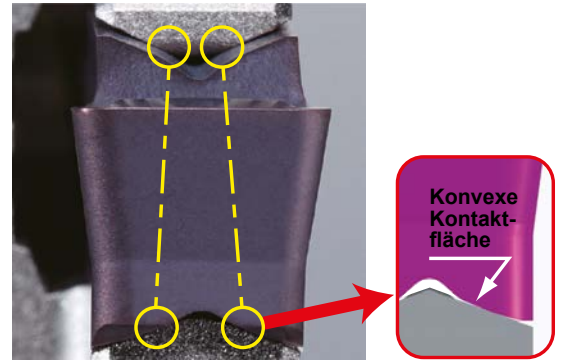
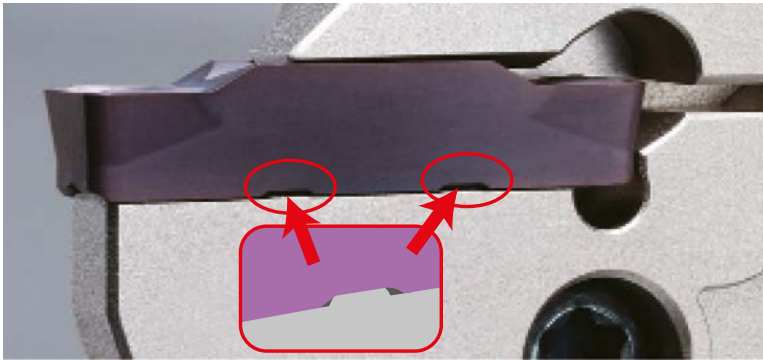

# TRIFORCE-System für höhere Stabilität und Leistung!

## TRIFORCE System

Das TRIFORCE-System stellt sicher, dass die Schneide sicher in 3 Richtungen (Seite, Vorderseite, Oberseite) befestigt ist, und somit hohe Steifigkeit für stabile Ein- und Abstechleistung sorgt.

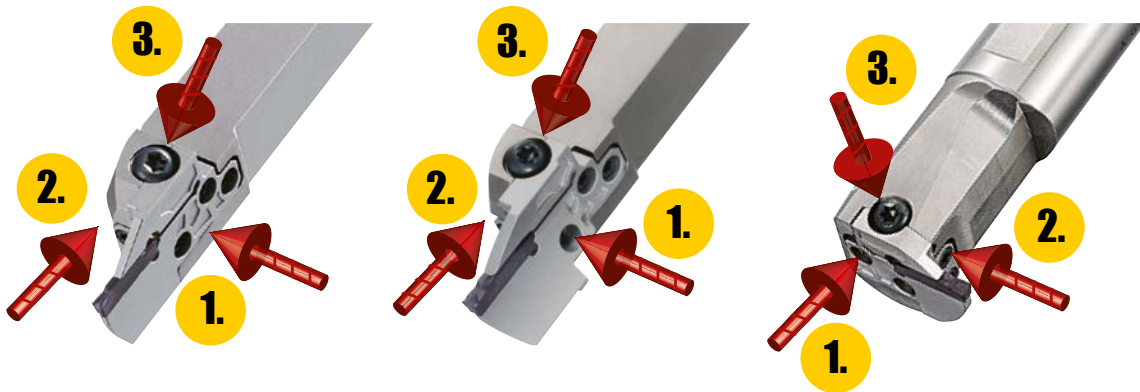

## BREITE WSP-AUSWAHL

● Auswahl der Stechbreiten



● Verschiedene Eckenradien verfügbar







# EINSTECHEN / ABSTECHEN

## WSP

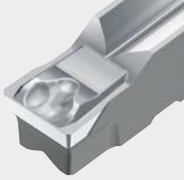
### ● Spanbrechersystem

Einstechen				
				
<b>GU-Spanbrecher</b> (Für langspanende Stähle)	<b>GS-Spanbrecher</b> (Geringer Vorschub)	<b>GM-Spanbrecher</b> (Mittlerer Vorschub)	<b>GFGS</b> (Für gehärteten Stahl)	<b>GL-Spanbrecher</b> (Für Aluminiumleg.)

Zum multifunktionalen Einstechen			Kopieren/Zum Freistechen
			
<b>MF-Spanbrecher</b> (G-Klasse)	<b>MS-Spanbrecher</b> (Geringer Vorschub)	<b>MM-Spanbrecher</b> (Mittlerer Vorschub)	<b>BM-Spanbrecher</b>

Abstechen				
				
<b>GU-Spanbrecher</b> (Für langspanende Stähle)	<b>GS-Spanbrecher</b> (Geringer Vorschub)	<b>GM-Spanbrecher</b> (Mittlerer Vorschub)	<b>R/L05-GM-Spanbrecher</b> (Mittlerer Vorschub)	<b>GL-Spanbrecher</b> (Für Aluminiumleg.)

EINSTECHEN / ABSTECHEN

## WSP SORTEN

Werkstoff	P	M	K	N	S	H
	Stahl	Rostfreier Stahl	Guss	Aluminiumleg.	Warmfeste Leg. / Titanleg.	Gehärteter Stahl
Stabile	<b>NX2525</b>					<b>BC8110</b>
Schnittdaten	<b>MY5015</b>		<b>MY5015</b>	<b>RT9010</b>	<b>MP9015</b>	
	<b>VP10RT</b>	<b>VP10RT</b>	<b>VP10RT</b>		<b>RT9010</b>	
	<b>VP20RT</b>	<b>VP20RT</b>	<b>VP20RT</b>		<b>MP9025</b>	
Instabil						



## MP9000-Serie

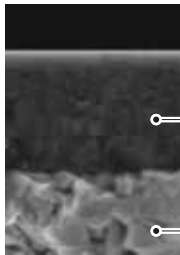

- Die (Al, Ti)N-Single Layer-Beschichtung mit hohem Aluminiumanteil bewirkt eine Stabilisierung der Härtungsphase und verbessert dadurch den Verschleißschutz, den Kolkverschleiß- und vermindert die Aufbauschneidenbildung erheblich.

(Al, Ti)N-Single Layer-Beschichtung mit hohem Aluminiumanteil

Spezielles Hartmetallsubstrat

## MY5015



- Die CVD-beschichtete Sorte MY5015 bietet eine ausgezeichnete Verschleißfestigkeit bei höheren Schnitttemperaturen. Bei der Bearbeitung von Gusseisen und duktilem Gusseisen erweist sich eine längere Werkzeugstandzeit. Auch einsetzbar für die Hochgeschwindigkeitsbearbeitung von Stahl unter stabilen Bedingungen, wie z.B. bei kontinuierlicher Bearbeitung.

CVD besch. Sorten

Hartmetallsubstrat

## VP20RT (1. Empfehlung)

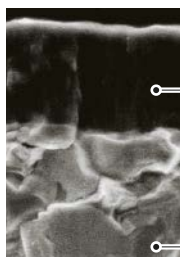

- PVD-beschichtete Sorte für einen breiten Anwendungsbereich. Die Kombination aus einem speziellen, zähen Hartmetallsubstrat mit der MIRACLE-Beschichtung bewirkt ein ausgezeichnetes Verhältnis zwischen Verschleiß- und Bruchfestigkeit.

MIRACLE Beschichtung

Hartmetallsubstrat (90.5HRA)

## RT9010

- Primär empfohlene Sorte für Titanlegierungen.

## NX2525

- NX2525 ist eine Cermet-Sorte zum Schlichten. Einsatz für die Schlichtzerspanung zur Erzielung einer glänzenden Oberfläche oder für Anwendungen mit geringer Schnittgeschwindigkeit.

## VP10RT (2. Empfehlung)

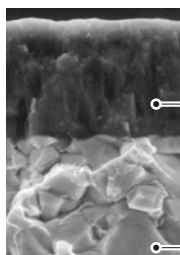

- PVD-beschichtete Sorte mit Feinstkorn-Hartmetallsubstrat, das härter ist als VP20RT. Einsetzbar bei schwer zu bearbeitenden Werkstoffen und für eine längere Werkzeugstandzeit.

MIRACLE Beschichtung

Hartmetallsubstrat (HRA92.0)

## BC8110

- Eine beschichtete PCBN-Sorte für den kontinuierlichen Schnitt, die bei der Bearbeitung von gehärtetem Stahl für eine längere Werkzeugstandzeit sorgt.

## Rohling

- WSP-Rohlinge für spezifische Anwendungen

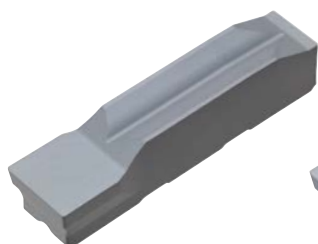

1 Schneidkante



2 Schneidkanten

## RT9010/RT9020 für WSP-Rohlinge

- Die 1. Empfehlung für WSP-Rohlinge ist RT9020 aufgrund des zähen Hartmetallsubstrats, das für einen breiteren Anwendungsbereich geeignet ist. RT9010 besitzt ein härteres Feinstkorn-Hartmetallsubstrat als RT9020 und ist ideal für eine längere Werkzeugstandzeit bei stabiler Bearbeitung geeignet. Für beide Sorten wird eine Beschichtung empfohlen, die für die jeweilige Anwendung geeignet ist.

\* WSP-Rohlinge müssen bedarfsgerecht selbst geschliffen werden.



# BESTELLBEZEICHNUNG SERIE GY

■ WSP

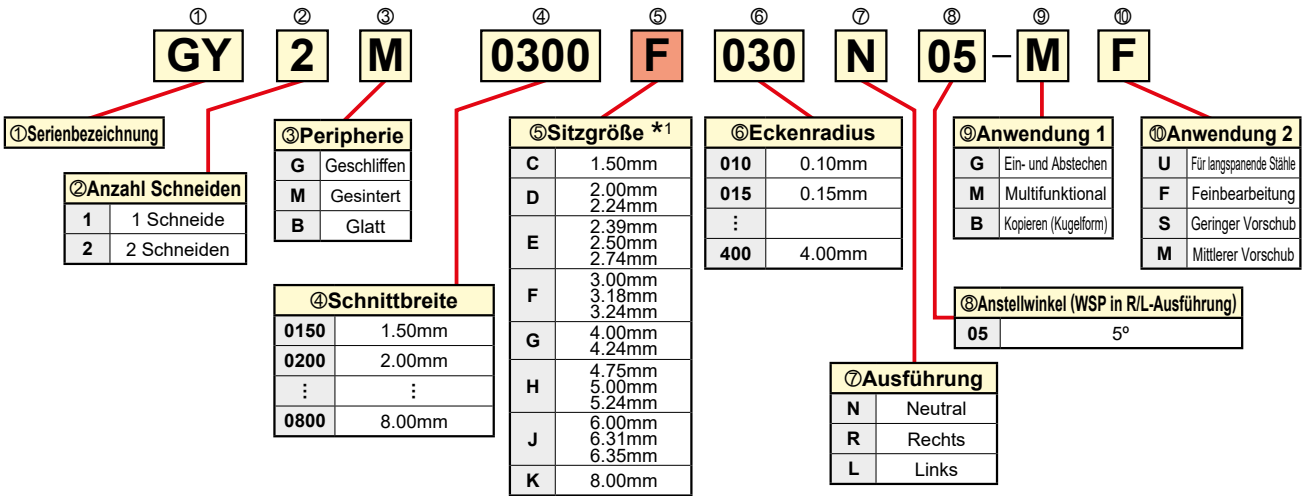

■ PCBN WSP

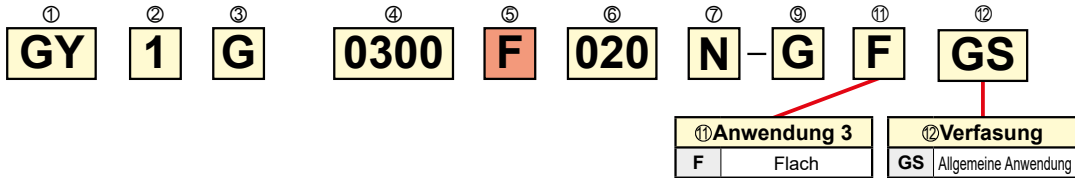

\*1 Wählen Sie eine Sitzgröße mit demselben Symbol, wie dem des modularen Schwertes und Monoblock-Halters.

■ MODULARES SCHWERT

● AUSSEN/INNENEINSTECHEN/ZUM FREISTECHEN

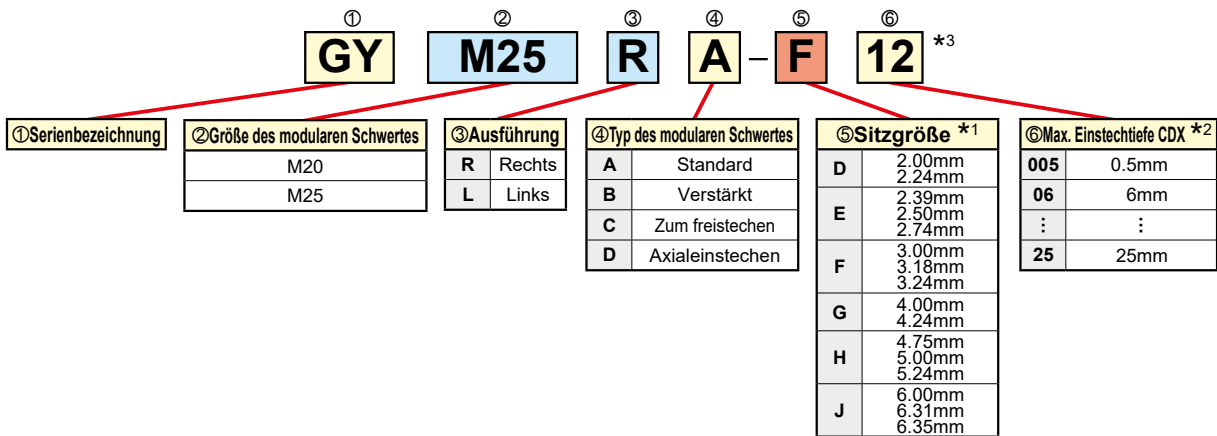

● AXIALEINSTECHEN

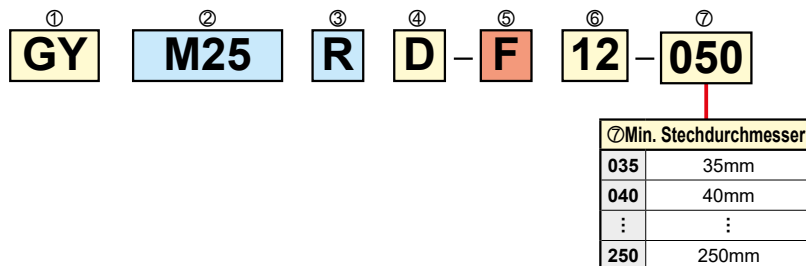

\*1 Wählen Sie eine Sitzgröße mit demselben Symbol wie dem der WSP.  
 \*2 Die maximale Einstechtiefe bezieht sich auf das radiale Einstechen und hängt von der eingesetzten WSP ab.  
 Für die maximale Einstechtiefe bei Innenbearbeitungen sehen Sie bitte auf Seite F082 – F088.  
 \*3 GYM20R/LA-10, GYM20R/LA-12, GYM25R/LA-12 und GYM25R/LA-14 können für das Innen- und Außeneinstechen verwendet werden.

## AUSSEN / AXIALEINSTECHEN / ZUM FREISTECHEN

### ● MONO-BLOCK-HALTER

① **GY** ② **P** ③ **R** ④ **2525** ⑤ **M** ⑥ **00** - ⑦ **K** ⑧ **25**

① **Serienbezeichnung**

③ **Ausführung des Halters**

R	Rechts
L	Links

② **Ausführungen**

P	Monoblock versetzt
Q	Ohne versetzten Monoblock
H	Modularer Halter

④ **Schaftdurchmesser (H x W)**

1010	10mmx10mm
1212	12mmx12mm
1616	16mmx16mm
2012	20mmx12mm
2020	20mmx20mm
2525	25mmx25mm
3225	32mmx25mm
3232	32mmx32mm

⑤ **Halterlänge LF**

J	110mm
JX	120mm
K	125mm
M	150mm
P	170mm

⑥ **Winkel (Grad)**

00	0°
50	50°
90	90°

⑦ **Sitzgröße \*1**

C	1.50mm
D	2.00mm 2.24mm
E	2.39mm 2.50mm 2.74mm
F	3.00mm 3.18mm 3.24mm
G	4.00mm 4.24mm
H	4.75mm 5.00mm 5.24mm
J	6.00mm 6.31mm 6.35mm
K	8.00mm

⑧ **Max. Einstechtiefe CDX**

06	6mm
08	8mm
:	:
25	25mm

### ● MODULARER HALTER

① **GY** ② **H** ③ **R** ④ **2525** ⑤ **M** ⑥ **00** - ⑨ **M25** ⑩ **R**

⑨ **Größe des modularen Schwertes**

M20
M25

⑩ **Ausführung des modularen Schwertes**

R	Rechts
L	Links

\*1 Wählen Sie eine Sitzgröße mit demselben Symbol wie dem der WSP.

## INNEN

### ● MONO-BLOCK-HALTER

① **GY** ② **A** ③ **R** ④ **20** ⑤ **K** ⑥ **90** ⑦ **A** - ⑧ **F** ⑨ **06**

① **Serienbezeichnung**

③ **Ausführung des Halters**

R	Rechts
L	Links

② **Ausführungen**

A	Einteilig
D	Modularer Halter

④ **Schaftdurchmesser DCON**

20	20mm
25	25mm
32	32mm
40	40mm
50	50mm

⑤ **Halterlänge LF**

K	125mm
L	140mm
M	150mm
P	170mm
Q	180mm
R	200mm
S	250mm
T	300mm

⑥ **Winkel (Grad)**

90	90°
----	-----

⑦ **Länge Freischliff**

A	30mm
B	40mm
C	50mm
D	60mm
F	80mm

⑧ **Sitzgröße \*1**

D	2.00mm 2.24mm
E	2.39mm 2.50mm 2.74mm
F	3.00mm 3.18mm 3.24mm
G	4.00mm 4.24mm
H	4.75mm 5.00mm 5.24mm
J	6.00mm 6.31mm 6.24mm

⑨ **Max. Einstechtiefe CDX**

06	6mm
07	7mm

### ● MODULARER HALTER

① **GY** ② **D** ③ **R** ④ **40** ⑤ **M** ⑥ **90** ⑦ **D** - ⑩ **M25** ⑪ **L**

⑩ **Größe des modularen Schwertes**

M20
M25

⑪ **Ausführung des modularen Schwertes**

R	Rechts
L	Links

\*1 Wählen Sie eine Sitzgröße mit demselben Symbol wie dem der WSP.

# BESTELLBEZEICHUNG PSC-HALTER

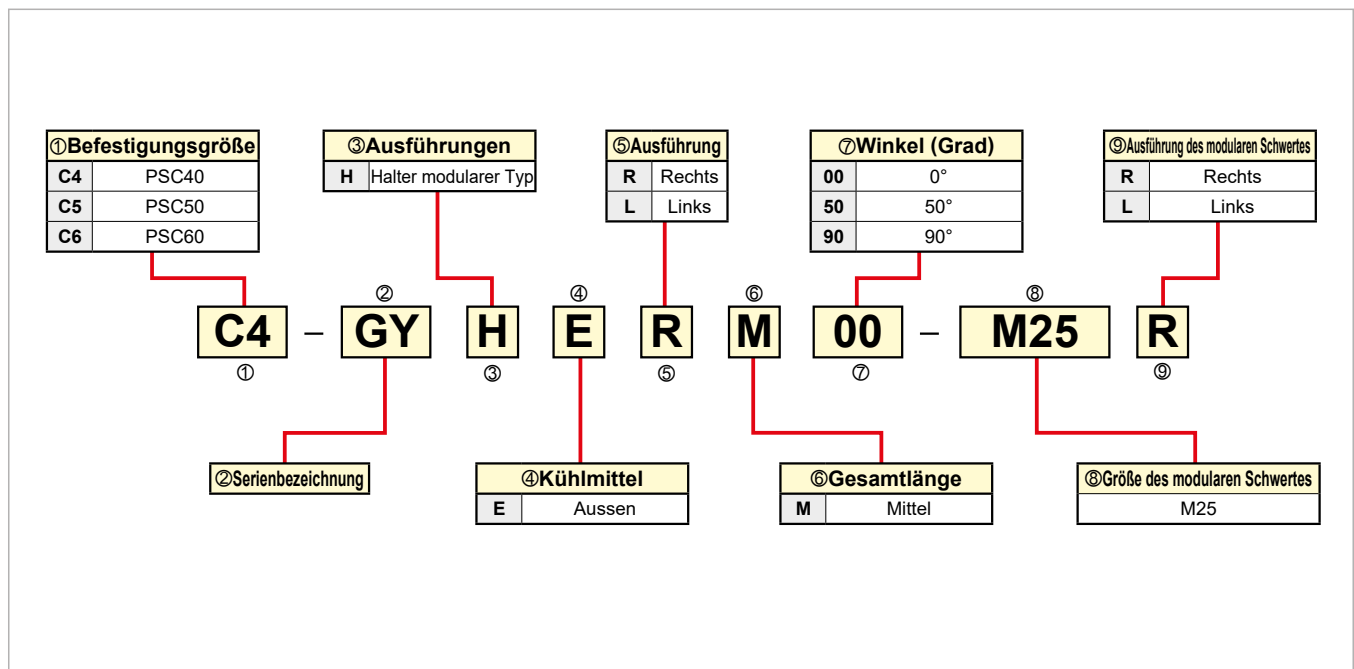

# Notizen

---

A series of horizontal dashed lines for writing notes, spanning the width of the page.

# WENDESCHNEIDPLATTEN DER GY-SERIE

## WSP

Anwendung	Geometrie	Bestellbezeichnung	Lager								Sitzgröße	Abmessungen (mm)						
			Beschichtet				Cermet		Hartmetall			CW		RER/L	CDX	*2		
			NEW	VP10RT	VP20RT	MY5015	NX2525	RT9010	RT9020	Stechbreite		Toleranz						
			MP9015	MP9025														
Zum Einstechen / Abstechen	<b>GU-Spanbrecher</b> (Für längspanende Stähle) 	GY2M0200D020N-GU			●	●	●					D	2.00	±0.03	0.2	19.7	20.70	
		GY2M0239E020N-GU			●	●	●						E	2.39	±0.03	0.2	19.8	20.70
		GY2M0250E020N-GU			●	●	●						E	2.50	±0.03	0.2	19.5	20.70
		GY2M0300F030N-GU			●	●	●						F	3.00	±0.03	0.3	19.3	20.70
		GY2M0318F030N-GU			●	●	●						F	3.18	±0.03	0.3	19.3	20.70
		GY2M0400G030N-GU			●	●	●						G	4.00	±0.04	0.3	24.2	25.65
		GY2M0475H040N-GU			●	●	●						H	4.75	±0.04	0.4	24.2	25.65
		GY2M0500H040N-GU			●	●	●						H	5.00	±0.04	0.4	24.2	25.65
		GY2M0600J040N-GU			●	●	●						J	6.00	±0.04	0.4	24.2	25.65
		GY2M0635J040N-GU			●	●	●						J	6.35	±0.04	0.4	24.2	25.65
Zum Einstechen / Abstechen	<b>GS-Spanbrecher</b> (Geringer Vorschub) 	GY2M0150C010N-GS			●	●	●					C	1.50	±0.03	0.1	13.4	14.70	
		GY2M0200D020N-GS			●	●	●						D	2.00	±0.03	0.2	18.7	20.70
		GY2M0239E020N-GS			●	●	●						E	2.39	±0.03	0.2	18.5	20.70
		GY2M0250E020N-GS			●	●	●						E	2.50	±0.03	0.2	18.5	20.70
		GY2M0300F020N-GS			●	●	●						F	3.00	±0.03	0.2	18.5	20.70
		GY2M0318F020N-GS			●	●	●						F	3.18	±0.03	0.2	18.5	20.70
		GY2M0400G020N-GS			●	●	●						G	4.00	±0.04	0.2	23.9	25.65
		GY2M0475H030N-GS			●	●	●						H	4.75	±0.04	0.3	23.9	25.65
		GY2M0500H030N-GS			●	●	●						H	5.00	±0.04	0.3	24.0	25.65
		GY2M0600J030N-GS			●	●	●						J	6.00	±0.04	0.3	24.1	25.65
GY2M0635J030N-GS			●	●	●						J	6.35	±0.04	0.3	24.1	25.65		
GY2M0800K030N-GS			●	●							K	8.00	±0.04	0.3	29.1	30.50		
Zum Einstechen / Abstechen	<b>GM-Spanbrecher</b> (Mittlerer Vorschub) 	GY1M0200D020N-GM	●	●	●	●	●					D	2.00	±0.03	0.2	—	20.70	
		GY1M0250E020N-GM	●	●	●	●	★						E	2.50	±0.03	0.2	—	20.70
		GY1M0300F030N-GM	●	●	●	●	●						F	3.00	±0.03	0.3	—	20.70
		GY1M0400G030N-GM	●	●	●	●	●						G	4.00	±0.04	0.3	—	25.65
		GY1M0500H040N-GM	●	●	●	●	●						H	5.00	±0.04	0.4	—	25.65
Zum Einstechen / Abstechen	<b>GM-Spanbrecher</b> (Mittlerer Vorschub) 	GY2M0150C020N-GM	●	●	●	●	●					C	1.50	±0.03	0.2	13.9	14.70	
		GY2M0200D020N-GM	●	●	●	●	●						D	2.00	±0.03	0.2	19.4	20.70
		GY2M0239E020N-GM	●	●	●	●	●						E	2.39	±0.03	0.2	19.4	20.70
		GY2M0250E020N-GM	●	●	●	●	●						E	2.50	±0.03	0.2	19.4	20.70
		GY2M0300F030N-GM	●	●	●	●	●						F	3.00	±0.03	0.3	19.4	20.70
		GY2M0318F030N-GM	●	●	●	●	●						F	3.18	±0.03	0.3	19.4	20.70
		GY2M0400G030N-GM	●	●	●	●	●						G	4.00	±0.04	0.3	24.4	25.65
		GY2M0475H040N-GM	●	●	●	●	●						H	4.75	±0.04	0.4	24.3	25.65
		GY2M0500H040N-GM	●	●	●	●	●						H	5.00	±0.04	0.4	24.3	25.65
		GY2M0600J040N-GM	●	●	●	●	●						J	6.00	±0.04	0.4	24.3	25.65
GY2M0635J040N-GM	●	●	●	●	●						J	6.35	±0.04	0.4	24.3	25.65		
GY2M0800K050N-GM	●	●	●	●	●						K	8.00	±0.04	0.5	29.3	30.50		
Zum Abstechen	<b>R/L05-GM-Spanbrecher</b>  Abbildung zeigt rechte WSP.	GY1M0200D020R05-GM			●	●						D	2.00	±0.03	0.2	—	20.80	
		GY1M0200D020L05-GM			★	●							D	2.00	±0.03	0.2	—	20.80
		GY1M0300F030R05-GM			●	●							F	3.00	±0.03	0.3	—	20.85
		GY1M0300F030L05-GM			●	●							F	3.00	±0.03	0.3	—	20.85

\*2 Das Maß hängt vom Spanbrecher ab. Siehe F017 „Umwandlungstabelle für L-Maßtoleranz“.

● : Lagerstandard. ★ : Lagerstandard in Japan.

(10 WSP je VPE) (CBN-WSP erhältlich in 1 WSP je VPE.)

Anwendung	Geometrie	Bestellbezeichnung	Lager						Sitzgröße	Abmessungen (mm)							
			Beschichtet			Hartmetall				CW		RER/L	CDX	*2			
			NEW	VP10RT	VP20RT	RT9010	CBN	BC8110		Stechbreite	Toleranz			L	LE		
			MP9015	MP9025													
Zum Abstechen	<b>R/L05-GM-Spanbrecher</b>  Abbildung zeigt rechte WSP.	GY2M0200D020R05-GM			●	●					D	2.00	±0.03	0.2	19.5	20.80	—
		GY2M0200D020L05-GM			●	●					D	2.00	±0.03	0.2	19.5	20.80	—
		GY2M0250E020R05-GM			●	●					E	2.50	±0.03	0.2	19.5	20.825	—
		GY2M0250E020L05-GM			●	●					E	2.50	±0.03	0.2	19.5	20.825	—
		GY2M0300F030R05-GM			●	●					F	3.00	±0.03	0.3	19.5	20.85	—
		GY2M0300F030L05-GM			●	●					F	3.00	±0.03	0.3	19.5	20.85	—
		GY2M0400G030R05-GM			●	●					G	4.00	±0.04	0.3	24.5	25.85	—
		GY2M0400G030L05-GM			●	●					G	4.00	±0.04	0.3	24.5	25.85	—
		GY2M0500H040R05-GM			●	●					H	5.00	±0.04	0.4	24.5	25.95	—
		GY2M0500H040L05-GM			●	●					H	5.00	±0.04	0.4	24.5	25.95	—
Zum Einstechen	<b>Plan (Für gehärteten Stahl)</b> 	GY1G0200D020N-GFGS							●	D	2.00	±0.03	0.2	—	20.70	2.7	
		GY1G0239E020N-GFGS							●	E	2.39	±0.03	0.2	—	20.70	2.7	
		GY1G0250E020N-GFGS							●	E	2.50	±0.03	0.2	—	20.70	2.7	
		GY1G0300F020N-GFGS							●	F	3.00	±0.03	0.2	—	20.70	2.7	
		GY1G0318F020N-GFGS							●	F	3.18	±0.03	0.2	—	20.70	2.7	
		GY1G0400G020N-GFGS							●	G	4.00	±0.03	0.2	—	25.65	2.7	
		GY1G0475H020N-GFGS							●	H	4.75	±0.03	0.2	—	25.65	2.7	
		GY1G0500H020N-GFGS							●	H	5.00	±0.03	0.2	—	25.65	2.7	
		GY1G0600J020N-GFGS							●	J	6.00	±0.03	0.2	—	25.65	2.7	
		Zum Einstechen / Abstechen	<b>GL-Spanbrecher (Für Aluminiumleg.)</b> 	GY2G0200D005N-GL					●			D	2.00	±0.02	0.05	19.5	21.05
GY2G0250E005N-GL							●				E	2.50	±0.02	0.05	19.1	21.05	—
GY2G0300F005N-GL							●				F	3.00	±0.02	0.05	18.9	21.05	—

# WENDESCHNEIDPLATTEN DER GY-SERIE

## WSP

Anwendung	Geometrie	Bestellbezeichnung	Lager						Sitzgröße	Abmessungen (mm)								
			Beschichtet			Cermet		Hartmetall		CW		RE RER/L	CDX	*2 L				
			NEW	MP9015	MP9025	VP10RT	VP20RT	MY5015		NX2525	RT9010				RT9020	Stechbreite	Toleranz	
Zum multifunktionalen Einstechen	<b>MF-Spanbrecher</b> (Schlichten)  	GY2G0200D020N-MF				●	●	●	●			D	2.00	±0.02	0.2	19.5	21.05	
		*1 GY2G0224D015N-MF				●	●	●	●			D	2.24	±0.02	0.15	19.8	21.05	
		GY2G0239E020N-MF				★	★	★	★			E	2.39	±0.02	0.2	19.2	21.05	
		GY2G0250E020N-MF				●	●	●	●			E	2.50	±0.02	0.2	19.4	21.05	
		*1 GY2G0274E020N-MF				●	●	●	●			E	2.74	±0.02	0.2	19.7	21.05	
		GY2G0300F020N-MF				●	●	●	●			F	3.00	±0.02	0.2	19.5	21.05	
		GY2G0300F040N-MF				●	●	●	●			F	3.00	±0.02	0.4	19.3	21.05	
		GY2G0318F020N-MF				★	★	★	★			F	3.18	±0.02	0.2	19.5	21.05	
		GY2G0318F040N-MF				★	★	★	★			F	3.18	±0.02	0.4	19.3	21.05	
		*1 GY2G0324F020N-MF				●	●	●	●			F	3.24	±0.02	0.2	19.5	21.05	
		GY2G0400G020N-MF				●	●	●	●			G	4.00	±0.02	0.2	24.9	25.95	
		GY2G0400G040N-MF				●	●	●	●			G	4.00	±0.02	0.4	24.7	25.95	
		GY2G0400G080N-MF				●	●	●	●			G	4.00	±0.02	0.8	24.3	25.95	
		*1 GY2G0424G020N-MF				●	●	●	●			G	4.24	±0.02	0.2	24.9	25.95	
		GY2G0475H020N-MF				★	★	★	★			H	4.75	±0.02	0.2	24.4	25.95	
		GY2G0475H040N-MF				★	★	★	★			H	4.75	±0.02	0.4	24.2	25.95	
		GY2G0475H080N-MF				★	★	★	★			H	4.75	±0.02	0.8	23.8	25.95	
		GY2G0500H020N-MF				●	●	●	●			H	5.00	±0.02	0.2	24.4	25.95	
		GY2G0500H040N-MF				●	●	●	●			H	5.00	±0.02	0.4	24.2	25.95	
		GY2G0500H080N-MF				●	●	●	●			H	5.00	±0.02	0.8	23.8	25.95	
		*1 GY2G0524H020N-MF				●	●	●	●			H	5.24	±0.02	0.2	24.4	25.95	
		GY2G0600J020N-MF				●	●	●	●			J	6.00	±0.02	0.2	24.4	25.95	
		GY2G0600J040N-MF				●	●	●	●			J	6.00	±0.02	0.4	24.2	25.95	
		GY2G0600J080N-MF				●	●	●	●			J	6.00	±0.02	0.8	23.8	25.95	
		*1 GY2G0631J020N-MF				●	●	●	●			J	6.31	±0.02	0.2	24.4	25.95	
		GY2G0635J020N-MF				★	★	★	★			J	6.35	±0.02	0.2	24.4	25.95	
		GY2G0635J040N-MF				★	★	★	★			J	6.35	±0.02	0.4	24.2	25.95	
		GY2G0635J080N-MF				★	★	★	★			J	6.35	±0.02	0.8	23.8	25.95	
Zum multifunktionalen Einstechen	<b>MS-Spanbrecher</b> (Geringer Vorschub)  	GY2M0200D020N-MS				●	●	●	●			D	2.00	±0.03	0.2	19.1	20.70	
		GY2M0250E020N-MS				●	●	●	●			E	2.50	±0.03	0.2	19.1	20.70	
		GY2M0300F020N-MS				●	●	●	●			F	3.00	±0.03	0.2	19.2	20.70	
		GY2M0300F040N-MS				●	●	●	●			F	3.00	±0.03	0.4	18.9	20.70	
		GY2M0400G020N-MS				●	●	●	●			G	4.00	±0.04	0.2	24.2	25.65	
		GY2M0400G040N-MS				●	●	●	●			G	4.00	±0.04	0.4	23.9	25.65	
		GY2M0500H040N-MS				●	●	●	●			H	5.00	±0.04	0.4	23.9	25.65	
		GY2M0500H080N-MS				●	●	●	●			H	5.00	±0.04	0.8	23.5	25.65	
		GY2M0600J040N-MS				●	●	●	●			J	6.00	±0.04	0.4	23.9	25.65	
		GY2M0600J080N-MS				●	●	●	●			J	6.00	±0.04	0.8	23.5	25.65	
		GY2M0800K080N-MS				●	●	●	●			K	8.00	±0.04	0.8	28.5	30.50	
		Zum multifunktionalen Einstechen	<b>MM-Spanbrecher</b> (Mittlerer Vorschub)  	GY2M0200D020N-MM	●	●	●	●	●	●				D	2.00	±0.03	0.2	19.1
GY2M0250E020N-MM	●			●	●	●	●	●	●				E	2.50	±0.03	0.2	19.1	20.70
GY2M0300F020N-MM	●			●	●	●	●	●	●				F	3.00	±0.03	0.2	19.1	20.70
GY2M0300F040N-MM	●			●	●	●	●	●	●				F	3.00	±0.03	0.4	18.9	20.70
GY2M0300F080N-MM	●			●	●	●	●	●	●				F	3.00	±0.03	0.8	18.5	20.70
GY2M0400G020N-MM	●			●	●	●	●	●	●				G	4.00	±0.04	0.2	24.1	25.65
GY2M0400G040N-MM	●			●	●	●	●	●	●				G	4.00	±0.04	0.4	23.9	25.65
GY2M0400G080N-MM	●			●	●	●	●	●	●				G	4.00	±0.04	0.8	23.5	25.65
GY2M0500H040N-MM	●			●	●	●	●	●	●				H	5.00	±0.04	0.4	23.9	25.65
GY2M0500H080N-MM	●			●	●	●	●	●	●				H	5.00	±0.04	0.8	23.5	25.65
GY2M0600J040N-MM	●			●	●	●	●	●	●				J	6.00	±0.04	0.4	23.9	25.65
GY2M0600J080N-MM	●			●	●	●	●	●	●				J	6.00	±0.04	0.8	23.5	25.65
GY2M0800K080N-MM	●	●	●	●	●	●	●				K	8.00	±0.04	0.8	28.5	30.50		
GY2M0800K120N-MM	●	●	●	●	●	●	●				K	8.00	±0.04	1.2	28.1	30.50		

\*1 Stechbreite entsprechend dem Sprengring.

\*2 Das Maß hängt vom Spanbrecher ab. Siehe F017 „Umwandlungstabelle für L-Maßtoleranz“.

● : Lagerstandard. ★ : Lagerstandard in Japan.



Anwendung	Geometrie	Bestellbezeichnung	Lager						Sitzgröße	Abmessungen (mm)						
			Beschichtet			Cermet		Hartmetall		CW		RE RER/L	CDX	*2 L		
			NEW MP9015	MP9025	VP10RT	VP20RT	MY5015	NX2525		RT9010	RT9020				Stechbreite	Toleranz
Zum Kopieren / Freisteichen		GY2M0200D100N-BM	●	●	●	●	●				D	2.00	±0.03	1.00	19.5	20.90
		GY2M0250E125N-BM	●	●	●	●	●				E	2.50	±0.03	1.25	19.3	20.90
		GY2M0300F150N-BM	●	●	●	●	●				F	3.00	±0.03	1.50	19.0	20.90
		GY2M0318F159N-BM	●	●	●	●	●				F	3.18	±0.03	1.59	18.9	20.90
		GY2M0400G200N-BM	●	●	●	●	●				G	4.00	±0.04	2.00	23.4	25.80
		GY2M0475H238N-BM	●	●	●	●	●				H	4.75	±0.04	2.38	22.9	25.80
		GY2M0500H250N-BM	●	●	●	●	●				H	5.00	±0.04	2.50	22.8	25.80
		GY2M0600J300N-BM	●	●	●	●	●				J	6.00	±0.04	3.00	22.5	25.90
		GY2M0635J318N-BM	●	●	●	●	●				J	6.35	±0.04	3.18	22.3	25.90
		GY2M0800K400N-BM	●	●	●	●	●				K	8.00	±0.04	4.00	26.5	30.80
*1 Glatt	2 Schneide	GY2B0220D020N					●	●	●	D	2.20	±0.10	0.2	—	21.05	
		NEW GY2B0250D020N					●	●	●	D	2.55	±0.10	0.2	—	21.28	
		GY2B0270E020N					●	●	●	E	2.70	±0.10	0.2	—	21.05	
		NEW GY2B0300E020N					●	●	●	E	3.05	±0.10	0.2	—	21.28	
		GY2B0340F020N					●	●	●	F	3.40	±0.10	0.2	—	21.05	
		NEW GY2B0360F020N					●	●	●	F	3.65	±0.10	0.2	—	21.28	
		GY2B0420G020N					●	●	●	G	4.20	±0.10	0.2	—	26.00	
		NEW GY2B0460G020N					●	●	●	G	4.65	±0.10	0.2	—	26.18	
		GY2B0520H020N					●	●	●	H	5.20	±0.10	0.2	—	26.00	
		NEW GY2B0560H020N					●	●	●	H	5.65	±0.10	0.2	—	26.18	
	GY2B0655J020N					●	●	●	J	6.55	±0.10	0.2	—	26.03		
	NEW GY2B0680J020N					●	●	●	J	6.85	±0.10	0.2	—	26.18		
	NEW GY2B0880K020N						●	●	K	8.85	±0.10	0.2	—	30.88		
	1 Schneide	GY1B0220D020N					●	●	●	D	2.20	±0.10	0.2	—	21.07	
		GY1B0270E020N					●	●	●	E	2.70	±0.10	0.2	—	21.10	
		GY1B0340F020N					●	●	●	F	3.40	±0.10	0.2	—	21.00	
		GY1B0420G020N					●	●	●	G	4.20	±0.10	0.2	—	25.86	
		GY1B0520H020N					●	●	●	H	5.20	±0.10	0.2	—	25.90	
		GY1B0655J020N					●	●	●	J	6.55	±0.10	0.2	—	25.90	



\*1 Stechbreite entsprechend dem Sprengring.

\*2 Das Maß hängt vom Spanbrecher ab. Siehe F017 „Umwandlungstabelle für L-Maßtoleranz“.

# EINSTECHEN / ABSTECHEN

Materialreferenz

## STANDARDLISTE FÜR SPRENGRINGE TYP C

Kategorie	Anwendung		Standard	Breite (Toleranz)										
				Für Welle				Für Loch						
Haltering Typ C 	Für Welle	Für Loch		0.5	+0.14 0	0.305	+0.051	1.15	+0.14 0	9	+0.14 0	0.457	+0.051	
				0.7		0.457	0	1.35				1.1	0.737	+0.076
				0.8		0.737		1.75				1.3	0.991	0
				0.9		0.991	+0.076	1.95				1.6	1.168	0
				1.1		1.168	0	2.2				1.85	1.422	+0.102
				1.3		1.422	+0.102	2.7				2.15	1.727	0
				1.6		1.727	0	3.2		+0.18		2.65	2.184	+0.127
				1.85		2.184	+0.127	4.2		0		3.15	2.616	0
				2.15		2.616	0					4.15	3.048	+0.127
				2.65		3.048	0					5.15		0
Konzentrischer Haltering Typ C 	Für Welle	Für Loch	ANSI B27.7/27.8 (US) BS 3673 (GB) DIN 471/472 (DE) NF E 22 163 (FR) UNI 7435/7438 (IT)  JIS B 2804 (JP)	3.15	+0.18 0	3.531	+0.152			6.2	+0.22 0			
				4.15										
				5.15										
				6.2										
Haltering Typ E 	Für Welle		N1***, amerikanisch	0.32	+0.05	0.305	+0.051	0.3	+0.05					
				0.5	0	0.457	0	0.4	0					
				0.7	+0.10	0.584	0	0.5	0					
				1.0	0	0.737	+0.076	0.7	+0.10					
				1.2	+0.14	0.991	0	0.9	0					
				1.4	0	1.168	0	1.15	+0.14					
						1.422	+0.102	1.75	0					
		1.727	0	2.2	0									

EINSTECHEN / ABSTECHEN

## O-RING STANDARDS

Kategorie	Standard	Breite (Toleranz)						
		Allgemein		Hydraulik		Pneumatik		
Für Stabilität	DIN 3770/3771 (DE)	2.54	+0.13 0	1.9	+0.1			
		3.18		2.3	0	2.3	+0.2 0	
		4.32		2.9	+0.15	3.1		
		6.1		3.6	0	3.7		
Für Dynamik	JIS B 2401 (JP) ISO 3601	3.2	+0.14 0	4.5	+0.2	6.4		+0.25 0
		4.0		5.5	+0.3	9.0		
		7.5		7.0	0	2.4		
		11.0		8.6	+0.4	3.6		
	SMS 1586/1588 (SE) BS 1806/4518 (GB)	2.39	+0.25 0	10.7	+0.5	7.1	+0.25 0	
		3.58		9.5	0	4.8		
		4.78				7.1		
		7.14				9.5		
		9.58						
	SAE AS-568 (US)	2.3	+0.2 0	2.2	+0.25 0	3.4	+0.25 0	
		3.1		4.6				
		3.7		6.9				
		6.4		9.3				

- G-Toleranz WSP mit MF-Spanbrecher ist für Einzelschrittbearbeitung erhältlich.
- WSP der GY-Serie ist für Einzelschrittbearbeitung erhältlich.
- Bearbeitung in mehreren Schritten durch axiales oder radiales Einstechen.

## UMWANDLUNGSTABELLE FÜR L-MASSTOLERANZ

Schnittbreite CW (mm)	*1 Abmessungen L (mm)	*2 Maßtoleranz (mm) im Vergleich zum Standardmaß (L) jedes Spanbrechers						
		GU	GS/GM	MS/MM	R/L-GM	Glatt	MF	BM
1.50	14.70		0					
2.00	20.70	0	0	0	0.10	0	0.35	0.20
2.24	*3 (20.7)						0.35	
2.39	20.70	0	0			0	0.35	
2.50	20.70	0	0	0	0.125	0	0.35	0.20
2.74	*3 (20.7)						0.35	
3.00	20.70	0	0	0	0.15	0	0.35	0.20
3.18	20.70	0	0			0	0.35	0.20
3.24	*3 (20.7)						0.35	
4.00	25.65	0	0	0	0.20	0	0.30	0.15
4.24	*3 (25.65)						0.30	
4.75	25.65	0	0			0	0.30	0.15
5.00	25.65	0	0	0	0.30	0	0.30	0.15
5.24	*3 (25.65)						0.30	
6.00	25.65	0	0	0		0	0.30	0.25
6.31	*3 (25.65)						0.30	
6.35	25.65	0	0				0.30	0.25
8.00	30.50		0	0				0.30

\*1 Dieser Wert wird in der beschriebenen Halterabmessung verwendet.

\*2  wenn es keinen anwendbaren Spanbrecher gibt.

\*3 Die hier dargestellten Standardabmessungen verwenden eine ungefähre WSP-Breite.

# GY SERIE (AUSSEN)

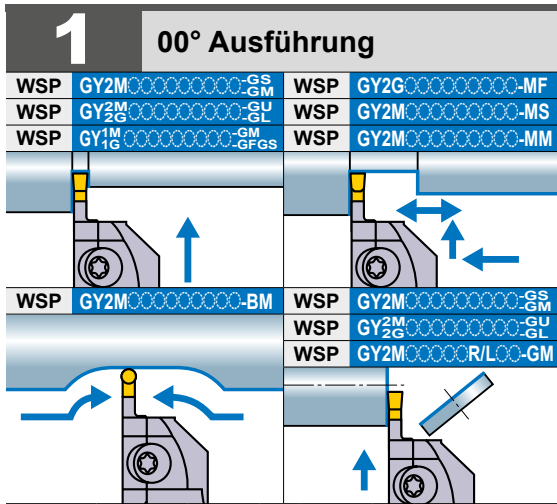

Hinweis 1) Modulare Schwerter und modulare Halter bitte separat bestellen.  
 Hinweis 2) Bitte Modul in Rechtsausführung für den Halter in Rechtsausführung und Modul in Linksausführung für den Halter in Linksausführung verwenden.



Abb. zeigt Rechtsausführung.

Sitzgröße	Abmessungen (mm)			Typ	Ausführung (R/L)	Bestellbezeichnung				Bild
	CW	CDX	CUTDIA			Halter	Lager	Modulares Schwert	Lager	
D	2.00 2.24	6	12	Modular	R	GYHR1616J00-M20R	●	GYM20RA-D06	●	3
				L	GYHL1616J00-M20L	●	GYM20LA-D06	●	3	
				Einteilig	R	GYQR2020K00-D06	●	—	—	7
				L	GYQL2020K00-D06	●	—	—	7	
				Modular	R	GYHR2020K00-M20R	●	GYM20RA-D06	●	1
				L	GYHL2020K00-M20L	●	GYM20LA-D06	●	1	
				Modular	R	GYHR2020K00-M25R	●	GYM25RA-D06	●	3
				L	GYHL2020K00-M25L	●	GYM25LA-D06	●	3	
				Einteilig	R	GYQR2525M00-D06	●	—	—	7
				L	GYQL2525M00-D06	●	—	—	7	
				Modular	R	GYHR2525M00-M25R	●	GYM25RA-D06	●	1
				L	GYHL2525M00-M25L	●	GYM25LA-D06	●	1	
				Modular	R	GYHR3225P00-M25R	●	GYM25RA-D06	●	5
				L	GYHL3225P00-M25L	●	GYM25LA-D06	●	5	
		Modular	R	GYHR3232P00-M25R	●	GYM25RA-D06	●	5		
		L	GYHL3232P00-M25L	●	GYM25LA-D06	●	5			
		10	20	Modular	R	GYHR1616J00-M20R	●	GYM20RA-D10	●	3
				L	GYHL1616J00-M20L	●	GYM20LA-D10	●	3	
				Modular	R	GYHR2020K00-M20R	●	GYM20RA-D10	●	1
				L	GYHL2020K00-M20L	●	GYM20LA-D10	●	1	
				Modular	R	GYHR2020K00-M25R	●	GYM25RA-D12	●	3
				L	GYHL2020K00-M25L	●	GYM25LA-D12	●	3	
		12	24	Modular	R	GYHR2525M00-M25R	●	GYM25RA-D12	●	1
				L	GYHL2525M00-M25L	●	GYM25LA-D12	●	1	
				Modular	R	GYHR3225P00-M25R	●	GYM25RA-D12	●	5
				L	GYHL3225P00-M25L	●	GYM25LA-D12	●	5	
				Modular	R	GYHR3232P00-M25R	●	GYM25RA-D12	●	5
				L	GYHL3232P00-M25L	●	GYM25LA-D12	●	5	
18 *4	36	Modular	R	GYHR1616J00-M20R	●	GYM20RB-D18	●	4		
		L	GYHL1616J00-M20L	●	GYM20LB-D18	●	4			
		Einteilig	R	GYQR2020K00-D18	●	—	—	7		
		L	GYQL2020K00-D18	●	—	—	7			
		Modular	R	GYHR2020K00-M20R	●	GYM20RB-D18	●	2		
		L	GYHL2020K00-M20L	●	GYM20LB-D18	●	2			
20 *1	40 *2	Modular	R	GYHR2020K00-M25R	●	GYM25RA-D20	●	4		
		L	GYHL2020K00-M25L	●	GYM25LA-D20	●	4			
		Einteilig	R	GYQR2525M00-D20	●	—	—	7		
		L	GYQL2525M00-D20	●	—	—	7			
		Modular	R	GYHR2525M00-M25R	●	GYM25RA-D20	●	2		
		L	GYHL2525M00-M25L	●	GYM25LA-D20	●	2			
		Modular	R	GYHR3225P00-M25R	●	GYM25RA-D20	●	6		
		L	GYHL3225P00-M25L	●	GYM25LA-D20	●	6			
		Modular	R	GYHR3232P00-M25R	●	GYM25RA-D20	●	6		
		L	GYHL3232P00-M25L	●	GYM25LA-D20	●	6			

\*1 Die maximale Einstechtiefe (CDX) hängt von der verwendeten Schneidplatte ab. Zur maximalen Einstechtiefe (CDX) bei verschiedenen Schneidplatten siehe Seite F012–F015.  
 \*2 Der maximale Abstechdurchmesser (CUTDIA) hängt von der verwendeten Schneidplatte ab. Der Abstechdurchmesser beträgt das Doppelte der maximalen Einstechtiefe (CDX) der Schneidplatten auf Seite F012–F015.  
 \*3 Die dargestellten Abmessungen gelten bei Verwendung von Standard-WSP. Wenn andere WSP-Geometrien verwendet werden, können die Werte für LF, LH, LH2 und WF variieren.  
 \*4 Die maximale Einstechtiefe (CDX) ist durch den Werkstückdurchmesser begrenzt. Siehe Seite F098 für weitere Hinweise.

● : Lagerstandard.

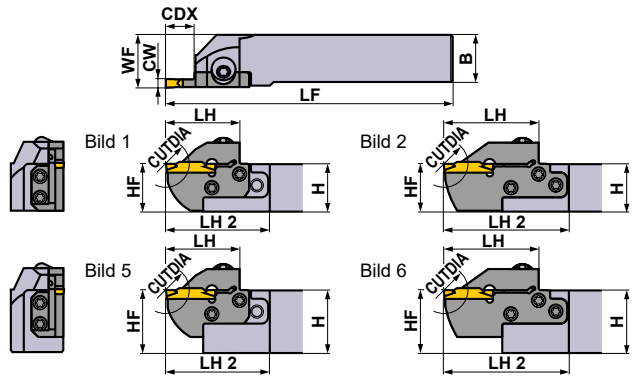
\* Schlüssel : ① : Spannschraube, ② : Schraube für Schwert







Abb. zeigt Rechtsausführung.

ERSATZTEILE			
Halter		 5 St.	 Schlüssel*
GYQR/L	HSC05020 (Spannmoment : 7.0N·m)	—	HKY40R
GYHR/L	GY06013M (Spannmoment : 6.0N·m)	TS407 (Spannmoment : 3.5N·m)	①TKY30R ②TKY15D
GYHR/L	GY06013M (Spannmoment : 6.0N·m)	TS55 (Spannmoment : 5.0N·m)	①TKY30R ②TKY25D

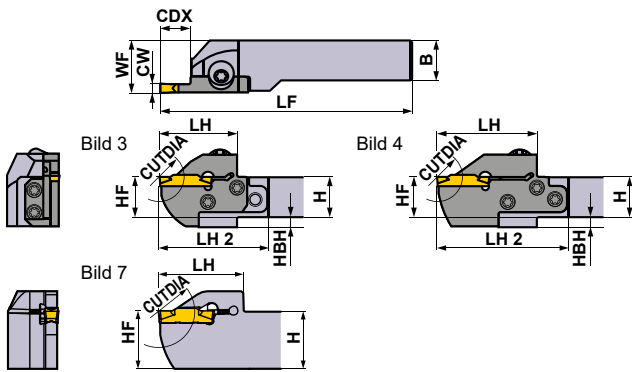
	Abmessungen (mm) *3								Schnittmodus	
	H	B	LF	LH	LH 2	HF	WF	HBH	Uhrzeigersinn	Gegen Uhrzeigersinn
	16	16	104	28	44	16	20	4		
	16	16	104	28	44	16	20	4		
	20	20	125	36	—	20	20.15	—		
	20	20	125	36	—	20	20.15	—		
	20	20	119	28	43	20	23	—		
	20	20	119	28	43	20	23	—		
	20	20	117	31	52	20	26	5		
	20	20	117	31	52	20	26	5		
	25	25	150	36	—	25	25.15	—		
	25	25	150	36	—	25	25.15	—		
	25	25	142	31	49	25	28	—		
	25	25	142	31	49	25	28	—		
	32	25	162	31	49	32	28	—		
	32	25	162	31	49	32	28	—		
	32	32	162	31	49	32	35	—		
	32	32	162	31	49	32	35	—		
	16	16	110	34	50	16	20	4		
	16	16	110	34	50	16	20	4		
	20	20	125	34	49	20	23	—		
	20	20	125	34	49	20	23	—		
	20	20	125	39	60	20	26	5		
	20	20	125	39	60	20	26	5		
	25	25	150	39	57	25	28	—		
	25	25	150	39	57	25	28	—		
	32	25	170	39	57	32	28	—		
	32	25	170	39	57	32	28	—		
	32	32	170	39	57	32	35	—		
	32	32	170	39	57	32	35	—		
	16	16	116	40	56	16	20	4		
	16	16	116	40	56	16	20	4		
	20	20	125	39	—	20	20.1	—		
	20	20	125	39	—	20	20.1	—		
	20	20	131	40	55	20	23	—		
	20	20	131	40	55	20	23	—		
	20	20	131	45	66	20	26	5		
	20	20	131	45	66	20	26	5		
	25	25	150	41	—	25	25.1	—		
	25	25	150	41	—	25	25.1	—		
	25	25	156	45	63	25	28	—		
	25	25	156	45	63	25	28	—		
	32	25	176	45	63	32	28	—		
	32	25	176	45	63	32	28	—		
	32	32	176	45	63	32	35	—		
	32	32	176	45	63	32	35	—		

WSP-Auswahl

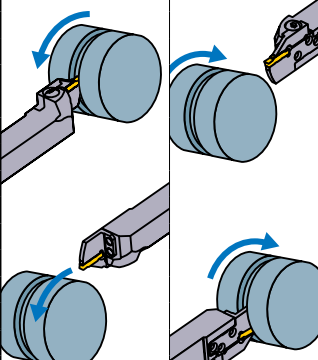
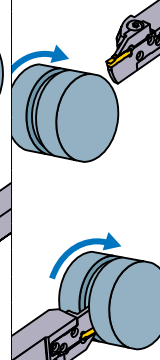
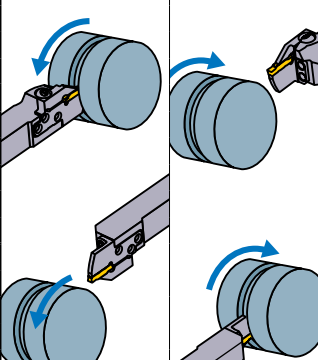
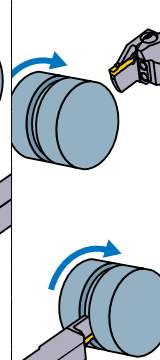
Sitzgröße	<b>Spannbrecher Bezeichnung</b>
D	GY000200/0224D — Spannbrecher nachstehend abgebildet

Spannbrecher zum Einstechen/Abstechen > F012, F013							
Sitzgröße	Spannbrecher	GU	GS	GM	GL	05-GM	GFGS
		(Für transparentes Stahl)	(Kleine Vorschübe)	(Mittlere Vorschübe)	(Aluminiumlegierung)	(Abstechen)	(Gehärteter Stahl)
CW	Neutral	Neutral	Neutral	Neutral	L/R	Neutral	
D	2.00mm	●	●	●	●	●	

Multifunktionsspannbrecher > F014, F015					
Sitzgröße	Spannbrecher	MF	MS	MM	BM
		(Schichten)	(Keine Vorschübe)	(Mittlere Vorschübe)	(Kopierdrehen, Freistechen)
CW	Neutral	●	●	●	Kugelform
D	2.00mm	●	●	●	●
	2.24mm	●			

● : Standard-WSP mit Abmessungen

IDENTIFIKATION > F008, F009  
 SCHNITTBEDINGUNGEN > F096  
 SICHERHEITSHINWEISE > F100

# GY SERIE (AUSSEN)

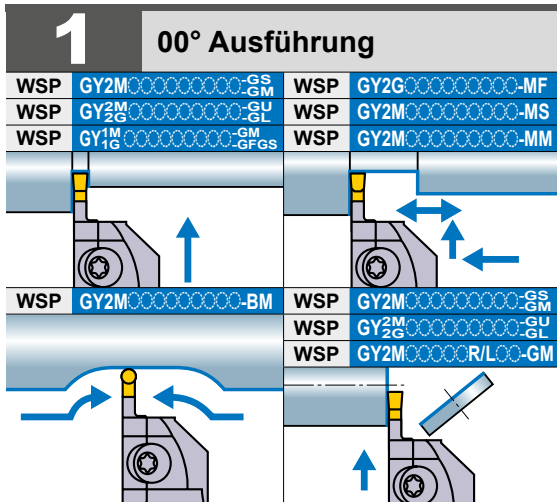

Hinweis 1) Modulare Schwerter und modulare Halter bitte separat bestellen.  
Hinweis 2) Bitte Modul in Rechtsausführung für den Halter in Rechtsausführung und Modul in Linksausführung für den Halter in Linksausführung verwenden.



Abb. zeigt Rechtsausführung.

Sitzgröße	Abmessungen (mm)			Typ	Ausführung (R/L)	Bestellbezeichnung				Bild
	CW	CDX	CUTDIA			Halter	Lager	Modulares Schwert	Lager	
E	2.39 2.50 2.74	6	12	Modular	R	GYHR1616J00-M20R	●	GYM20RA-E06	●	3
				Modular	L	GYHL1616J00-M20L	●	GYM20LA-E06	●	3
				Modular	R	GYHR2020K00-M20R	●	GYM20RA-E06	●	1
				Modular	L	GYHL2020K00-M20L	●	GYM20LA-E06	●	1
				Modular	R	GYHR2020K00-M25R	●	GYM25RA-E06	●	3
				Modular	L	GYHL2020K00-M25L	●	GYM25LA-E06	●	3
		Modular	R	GYHR2525M00-M25R	●	GYM25RA-E06	●	1		
		Modular	L	GYHL2525M00-M25L	●	GYM25LA-E06	●	1		
		Modular	R	GYHR3225P00-M25R	●	GYM25RA-E06	●	5		
		Modular	L	GYHL3225P00-M25L	●	GYM25LA-E06	●	5		
		Modular	R	GYHR3232P00-M25R	●	GYM25RA-E06	●	5		
		Modular	L	GYHL3232P00-M25L	●	GYM25LA-E06	●	5		
	Modular	R	GYHR1616J00-M20R	●	GYM20RA-E10	●	3			
	Modular	L	GYHL1616J00-M20L	●	GYM20LA-E10	●	3			
	Modular	R	GYHR2020K00-M20R	●	GYM20RA-E10	●	1			
	Modular	L	GYHL2020K00-M20L	●	GYM20LA-E10	●	1			
	Modular	R	GYHR2020K00-M25R	●	GYM25RA-E12	●	3			
	Modular	L	GYHL2020K00-M25L	●	GYM25LA-E12	●	3			
	Modular	R	GYHR2525M00-M25R	●	GYM25RA-E12	●	1			
	Modular	L	GYHL2525M00-M25L	●	GYM25LA-E12	●	1			
	Modular	R	GYHR3225P00-M25R	●	GYM25RA-E12	●	5			
	Modular	L	GYHL3225P00-M25L	●	GYM25LA-E12	●	5			
	Modular	R	GYHR3232P00-M25R	●	GYM25RA-E12	●	5			
	Modular	L	GYHL3232P00-M25L	●	GYM25LA-E12	●	5			
Modular	R	GYHR1616J00-M20R	●	GYM20RB-E18	●	4				
Modular	L	GYHL1616J00-M20L	●	GYM20LB-E18	●	4				
Modular	R	GYHR2020K00-M20R	●	GYM20RB-E18	●	2				
Modular	L	GYHL2020K00-M20L	●	GYM20LB-E18	●	2				
Modular	R	GYHR2020K00-M25R	●	GYM25RA-E20	●	4				
Modular	L	GYHL2020K00-M25L	●	GYM25LA-E20	●	4				
Modular	R	GYHR2525M00-M25R	●	GYM25RA-E20	●	2				
Modular	L	GYHL2525M00-M25L	●	GYM25LA-E20	●	2				
Modular	R	GYHR3225P00-M25R	●	GYM25RA-E20	●	6				
Modular	L	GYHL3225P00-M25L	●	GYM25LA-E20	●	6				
Modular	R	GYHR3232P00-M25R	●	GYM25RA-E20	●	6				
Modular	L	GYHL3232P00-M25L	●	GYM25LA-E20	●	6				

\*1 Die maximale Einstechtiefe (CDX) hängt von der verwendeten Schneidplatte ab. Zur maximalen Einstechtiefe (CDX) bei verschiedenen Schneidplatten siehe Seite F012–F015.

\*2 Der maximale Abstechdurchmesser (CUTDIA) hängt von der verwendeten Schneidplatte ab. Der Abstechdurchmesser beträgt das Doppelte der maximalen Einstechtiefe (CDX) der Schneidplatten auf Seite F012–F015.

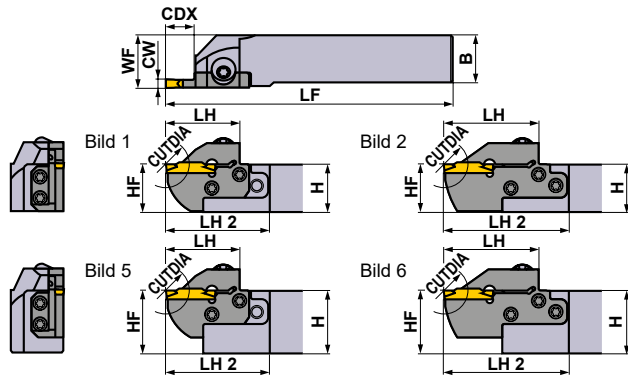
\*3 Die dargestellten Abmessungen gelten bei Verwendung von Standard-WSP. Wenn andere WSP-Geometrien verwendet werden, können die Werte für LF, LH, LH2 und WF variieren.

\*4 Die maximale Einstechtiefe (CDX) ist durch den Werkstückdurchmesser begrenzt. Siehe Seite F098 für weitere Hinweise.

● : Lagerstandard.

\* Schlüssel : ① : Spannschraube, ② : Schraube für Schwert











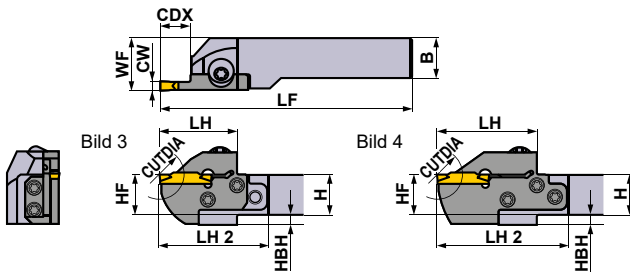

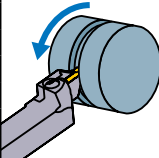
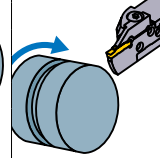
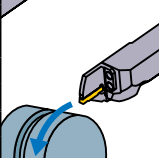
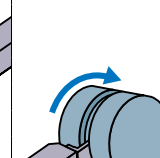
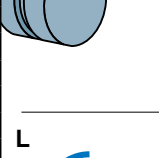
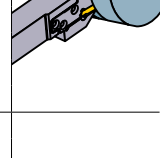
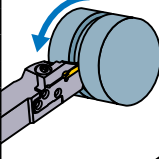
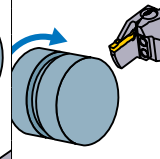
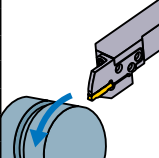
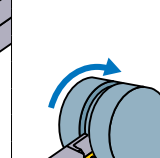

Abb. zeigt Rechtsausführung.

ERSATZTEILE			
Halter		 5 St.	 Schlüssel*
GYQR/L	HSC05020 (Spannmoment : 7.0N·m)	—	HKY40R
GYHR/L	GY06013M (Spannmoment : 6.0N·m)	TS407 (Spannmoment : 3.5N·m)	①TKY30R ②TKY15D
GYHR/L			①TKY30R ②TKY25D

	Abmessungen (mm) *3								Schnittmodus	
	H	B	LF	LH	LH 2	HF	WF	HBH	Uhrzeigersinn	Gegen Uhrzeigersinn
	16	16	104	28	44	16	20	4	R	
	16	16	104	28	44	16	20	4		
	20	20	119	28	43	20	23	—		
	20	20	119	28	43	20	23	—		
	20	20	117	31	52	20	26	5		
	20	20	117	31	52	20	26	5		
	25	25	142	31	49	25	28	—		
	25	25	142	31	49	25	28	—		
	32	25	162	31	49	32	28	—		
	32	25	162	31	49	32	28	—		
	32	32	162	31	49	32	35	—		
	32	32	162	31	49	32	35	—		
	16	16	110	34	50	16	20	4		
	16	16	110	34	50	16	20	4		
	20	20	125	34	49	20	23	—		
	20	20	125	34	49	20	23	—		
	20	20	125	39	60	20	26	5		
	20	20	125	39	60	20	26	5		
	25	25	150	39	57	25	28	—		
	25	25	150	39	57	25	28	—		
	32	25	170	39	57	32	28	—		
	32	25	170	39	57	32	28	—		
	32	32	170	39	57	32	35	—		
	32	32	170	39	57	32	35	—		
	16	16	116	40	56	16	20	4		
	16	16	116	40	56	16	20	4		
	20	20	131	40	55	20	23	—		
	20	20	131	40	55	20	23	—		
	20	20	131	45	66	20	26	5		
	20	20	131	45	66	20	26	5		
	25	25	156	45	63	25	28	—		
	25	25	156	45	63	25	28	—		
	32	25	176	45	63	32	28	—		
	32	25	176	45	63	32	28	—		
	32	32	176	45	63	32	35	—		
	32	32	176	45	63	32	35	—		

WSP-Auswahl

Sitzgröße	Spannbrecher Bezeichnung
E	GY0239/0250/0274E — Spannbrecher nachstehend abgebildet

Sitzgröße	Spannbrecher	Spannbrecher zum Einstechen/Abstechen > F012, F013					
		GU (Für transparente Sitze)	GS (Kleine Vorschübe)	GM (Mittlere Vorschübe)	GL (Aluminiumlegierung)	05-GM (Abstechen)	GFGS (Gehärteter Stahl)
E	CW	Neutral	Neutral	Neutral	Neutral	L/R	Neutral
	2.39mm	●	●	●	●	●	●
	2.50mm	●	●	●	●	●	●

Sitzgröße	Spannbrecher	Multifunktionsspannbrecher > F014, F015			
		MF (Schichten)	MS (Keine Vorschübe)	MM (Mittlere Vorschübe)	BM (Kopierdrehen, Freistechen)
E	CW	●	●	●	Kugelform
	2.39mm	●	●	●	●
	2.50mm	●	●	●	●
	2.74mm	●	●	●	●

● : Standard-WSP mit Abmessungen

IDENTIFIKATION > F008, F009  
 SCHNITTBEDINGUNGEN > F096  
 SICHERHEITSHINWEISE > F100



# GY SERIE (AUSSEN)

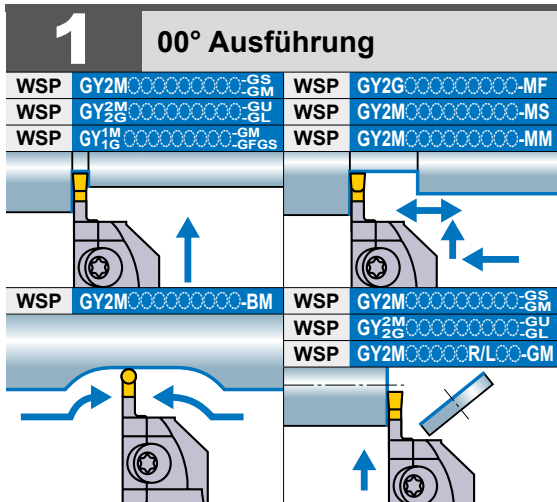

Hinweis 1) Modulare Schwerter und modulare Halter bitte separat bestellen.  
Hinweis 2) Bitte Modul in Rechtsausführung für den Halter in Rechtsausführung und Modul in Linksausführung für den Halter in Linksausführung verwenden.



Abb. zeigt Rechtsausführung.

Sitzgröße	Abmessungen (mm)			Typ	Ausführung (R/L)	Bestellbezeichnung				Bild
	CW	CDX	CUTDIA			Halter	Lager	Modulares Schwert	Lager	
F	3.00 3.18 3.24	6	12	Modular	R	GYHR1616J00-M20R	●	GYM20RA-F06	●	3
				Modular	L	GYHL1616J00-M20L	●	GYM20LA-F06	●	3
				Einteilig	R	GYQR2020K00-F06	●	—	—	7
				Einteilig	L	GYQL2020K00-F06	●	—	—	7
				Modular	R	GYHR2020K00-M20R	●	GYM20RA-F06	●	1
				Modular	L	GYHL2020K00-M20L	●	GYM20LA-F06	●	1
				Modular	R	GYHR2020K00-M25R	●	GYM25RA-F06	●	3
				Modular	L	GYHL2020K00-M25L	●	GYM25LA-F06	●	3
				Einteilig	R	GYQR2525M00-F06	●	—	—	7
				Einteilig	L	GYQL2525M00-F06	●	—	—	7
				Modular	R	GYHR2525M00-M25R	●	GYM25RA-F06	●	1
				Modular	L	GYHL2525M00-M25L	●	GYM25LA-F06	●	1
				Modular	R	GYHR3225P00-M25R	●	GYM25RA-F06	●	5
				Modular	L	GYHL3225P00-M25L	●	GYM25LA-F06	●	5
		Modular	R	GYHR3232P00-M25R	●	GYM25RA-F06	●	5		
		Modular	L	GYHL3232P00-M25L	●	GYM25LA-F06	●	5		
		10	20	Modular	R	GYHR1616J00-M20R	●	GYM20RA-F10	●	3
				Modular	L	GYHL1616J00-M20L	●	GYM20LA-F10	●	3
				Modular	R	GYHR2020K00-M20R	●	GYM20RA-F10	●	1
				Modular	L	GYHL2020K00-M20L	●	GYM20LA-F10	●	1
				Modular	R	GYHR2020K00-M25R	●	GYM25RA-F12	●	3
				Modular	L	GYHL2020K00-M25L	●	GYM25LA-F12	●	3
		12	24	Modular	R	GYHR2525M00-M25R	●	GYM25RA-F12	●	1
				Modular	L	GYHL2525M00-M25L	●	GYM25LA-F12	●	1
				Modular	R	GYHR3225P00-M25R	●	GYM25RA-F12	●	5
				Modular	L	GYHL3225P00-M25L	●	GYM25LA-F12	●	5
		18 *4	36	Modular	R	GYHR3232P00-M25R	●	GYM25RA-F12	●	5
				Modular	L	GYHL3232P00-M25L	●	GYM25LA-F12	●	5
Modular	R			GYHR1616J00-M20R	●	GYM20RB-F18	●	4		
Modular	L			GYHL1616J00-M20L	●	GYM20LB-F18	●	4		
20 *1	40 *2	Einteilig	R	GYQR2020K00-F18	●	—	—	7		
		Einteilig	L	GYQL2020K00-F18	●	—	—	7		
		Modular	R	GYHR2020K00-M20R	●	GYM20RB-F18	●	2		
		Modular	L	GYHL2020K00-M20L	●	GYM20LB-F18	●	2		
		Modular	R	GYHR2020K00-M25R	●	GYM25RA-F20	●	4		
		Modular	L	GYHL2020K00-M25L	●	GYM25LA-F20	●	4		
		Einteilig	R	GYQR2525M00-F20	●	—	—	7		
		Einteilig	L	GYQL2525M00-F20	●	—	—	7		
		Modular	R	GYHR2525M00-M25R	●	GYM25RA-F20	●	2		
		Modular	L	GYHL2525M00-M25L	●	GYM25LA-F20	●	2		
20 *1	40 *2	Modular	R	GYHR3225P00-M25R	●	GYM25RA-F20	●	6		
		Modular	L	GYHL3225P00-M25L	●	GYM25LA-F20	●	6		
		Modular	R	GYHR3232P00-M25R	●	GYM25RA-F20	●	6		
		Modular	L	GYHL3232P00-M25L	●	GYM25LA-F20	●	6		

\*1 Die maximale Einstechtiefe (CDX) hängt von der verwendeten Schneidplatte ab. Zur maximalen Einstechtiefe (CDX) bei verschiedenen Schneidplatten siehe Seite F012–F015.  
\*2 Der maximale Abstechdurchmesser (CUTDIA) hängt von der verwendeten Schneidplatte ab. Der Abstechdurchmesser beträgt das Doppelte der maximalen Einstechtiefe (CDX) der Schneidplatten auf Seite F012–F015.  
\*3 Die dargestellten Abmessungen gelten bei Verwendung von Standard-WSP. Wenn andere WSP-Geometrien verwendet werden, können die Werte für LF, LH, LH2 und WF variieren.  
\*4 Die maximale Einstechtiefe (CDX) ist durch den Werkstückdurchmesser begrenzt. Siehe Seite F098 für weitere Hinweise.

● : Lagerstandard.

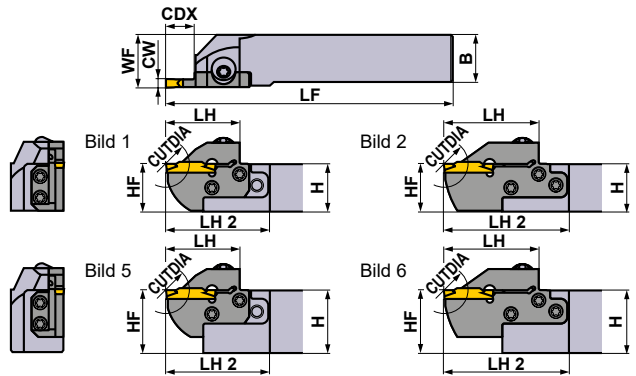
\* Schlüssel : ① : Spannschraube, ② : Schraube für Schwert



Abb. zeigt Rechtsausführung.

ERSATZTEILE			
Halter			
	Spannschraube	Schraube für Schwert 5 St.	Schlüssel*
GYQR/L	HSC05020 (Spannmoment : 7.0N·m)	—	HKY40R
GYHR/L	GY06013M (Spannmoment : 6.0N·m)	TS407 (Spannmoment : 3.5N·m)	①TKY30R ②TKY15D
GYHR/L			TS55 (Spannmoment : 5.0N·m)

	Abmessungen (mm) *3								Schnittmodus	
	H	B	LF	LH	LH 2	HF	WF	HBH	Uhrzeigersinn	Gegen Uhrzeigersinn
	16	16	104	28	44	16	20	4		
	16	16	104	28	44	16	20	4		
	20	20	125	36	—	20	20.3	—		
	20	20	125	36	—	20	20.3	—		
	20	20	119	28	43	20	23	—		
	20	20	119	28	43	20	23	—		
	20	20	117	31	52	20	26	5		
	20	20	117	31	52	20	26	5		
	25	25	150	36	—	25	25.3	—		
	25	25	150	36	—	25	25.3	—		
	25	25	142	31	49	25	28	—		
	25	25	142	31	49	25	28	—		
	32	25	162	31	49	32	28	—		
	32	25	162	31	49	32	28	—		
	32	32	162	31	49	32	35	—		
	32	32	162	31	49	32	35	—		
	16	16	110	34	50	16	20	4		
	16	16	110	34	50	16	20	4		
	20	20	125	34	49	20	23	—		
	20	20	125	34	49	20	23	—		
	20	20	125	39	60	20	26	5		
	20	20	125	39	60	20	26	5		
	25	25	150	39	57	25	28	—		
	25	25	150	39	57	25	28	—		
	32	25	170	39	57	32	28	—		
	32	25	170	39	57	32	28	—		
	32	32	170	39	57	32	35	—		
	32	32	170	39	57	32	35	—		
	16	16	116	40	56	16	20	4		
	16	16	116	40	56	16	20	4		
	20	20	125	39	—	20	20.25	—		
	20	20	125	39	—	20	20.25	—		
	20	20	131	40	55	20	23	—		
	20	20	131	40	55	20	23	—		
	20	20	131	45	66	20	26	5		
	20	20	131	45	66	20	26	5		
	25	25	150	41	—	25	25.25	—		
	25	25	150	41	—	25	25.25	—		
	25	25	156	45	63	25	28	—		
	25	25	156	45	63	25	28	—		
	32	25	176	45	63	32	28	—		
	32	25	176	45	63	32	28	—		
	32	32	176	45	63	32	35	—		
	32	32	176	45	63	32	35	—		

WSP-Auswahl

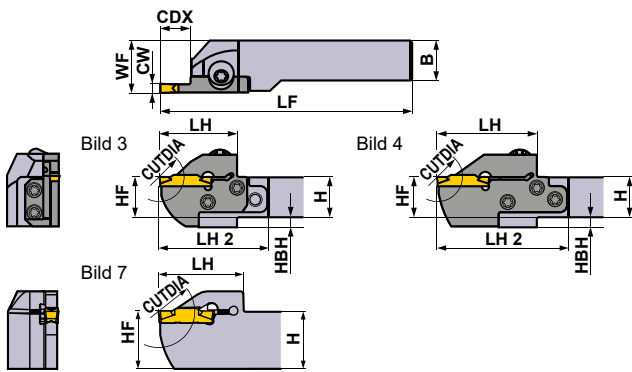
Sitzgröße	Spannbrecher Bezeichnung
F	GY00239/0250/0274E

Sitzgröße	Spannbrecher	GU	GS	GM	GL	05-GM	GFGS
		(Für transparentes Stahl)	(Kleine Vorschübe)	(Mittlere Vorschübe)	(Aluminiumlegierung)	(Abstechen)	(Gehärteter Stahl)
F	3.00mm	●	●	●	●	●	●
	3.18mm	●	●	●	●	●	●

Sitzgröße	Spannbrecher	MF	MS	MM	BM
		(Schichten)	(Keine Vorschübe)	(Mittlere Vorschübe)	(Kopierdrehen, Freistechen)
F	3.00mm				●
	RE 0.2	●	●	●	
	RE 0.4	●	●	●	
	RE 0.8			●	
	3.18mm				●
	3.24mm	●			

● : Standard-WSP mit Abmessungen

IDENTIFIKATION > F008, F009  
 SCHNITTBEDINGUNGEN > F096  
 SICHERHEITSHINWEISE > F100

# GY SERIE (AUSSEN)

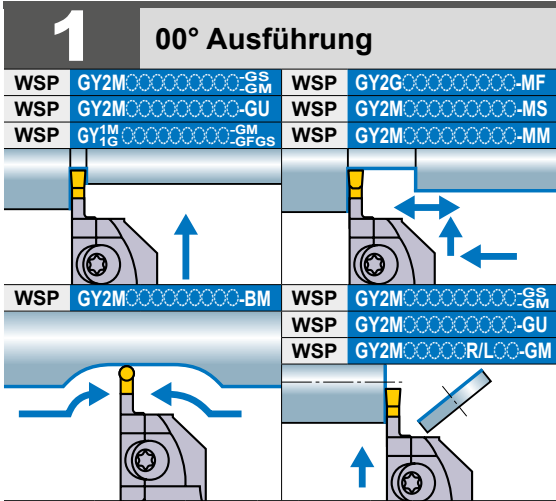

Hinweis 1) Modulare Schwerter und modulare Halter bitte separat bestellen.  
 Hinweis 2) Spitze Modul in Rechtsausführung für den Halter in Rechtsausführung und Modul in Linksausführung für den Halter in Linksausführung verwenden.



Abb. zeigt Rechtsausführung.

Sitzgröße	Abmessungen (mm)			Typ	Ausführung (R/L)	Bestellbezeichnung				Bild
	CW	CDX	CUTDIA			Halter	Lager	Modulares Schwert	Lager	
G	4.00 4.24	8	16	Einteilig	R	GYQR2020K00-G08	●	—	—	7
				L	GYQL2020K00-G08	●	—	—	7	
				Modular	R	GYHR2020K00-M25R	●	GYM25RA-G08	●	3
				L	GYHL2020K00-M25L	●	GYM25LA-G08	●	3	
				Einteilig	R	GYQR2525M00-G08	●	—	—	7
				L	GYQL2525M00-G08	●	—	—	7	
		Modular	R	GYHR2525M00-M25R	●	GYM25RA-G08	●	1		
		L	GYHL2525M00-M25L	●	GYM25LA-G08	●	1			
		Modular	R	GYHR3225P00-M25R	●	GYM25RA-G08	●	5		
		L	GYHL3225P00-M25L	●	GYM25LA-G08	●	5			
		Modular	R	GYHR3232P00-M25R	●	GYM25RA-G08	●	5		
		L	GYHL3232P00-M25L	●	GYM25LA-G08	●	5			
	Modular	R	GYHR1616J00-M20R	●	GYM20RA-G12	●	3			
	L	GYHL1616J00-M20L	●	GYM20LA-G12	●	3				
	Modular	R	GYHR2020K00-M20R	●	GYM20RA-G12	●	1			
	L	GYHL2020K00-M20L	●	GYM20LA-G12	●	1				
	Modular	R	GYHR2020K00-M25R	●	GYM25RA-G14	●	3			
	L	GYHL2020K00-M25L	●	GYM25LA-G14	●	3				
	Modular	R	GYHR2525M00-M25R	●	GYM25RA-G14	●	1			
	L	GYHL2525M00-M25L	●	GYM25LA-G14	●	1				
	Modular	R	GYHR3225P00-M25R	●	GYM25RA-G14	●	5			
	L	GYHL3225P00-M25L	●	GYM25LA-G14	●	5				
	Modular	R	GYHR3232P00-M25R	●	GYM25RA-G14	●	5			
	L	GYHL3232P00-M25L	●	GYM25LA-G14	●	5				
Modular	R	GYHR2020K00-G25	●	—	—	8				
L	GYQL2020K00-G25	●	—	—	8					
Modular	R	GYHR2020K00-M25R	●	GYM25RA-G25	●	4				
L	GYHL2020K00-M25L	●	GYM25LA-G25	●	4					
Einteilig	R	GYQR2525M00-G25	●	—	—	7				
L	GYQL2525M00-G25	●	—	—	7					
Modular	R	GYHR2525M00-M25R	●	GYM25RA-G25	●	2				
L	GYHL2525M00-M25L	●	GYM25LA-G25	●	2					
Modular	R	GYHR3225P00-M25R	●	GYM25RA-G25	●	6				
L	GYHL3225P00-M25L	●	GYM25LA-G25	●	6					
Modular	R	GYHR3232P00-M25R	●	GYM25RA-G25	●	6				
L	GYHL3232P00-M25L	●	GYM25LA-G25	●	6					

- \*1 Die maximale Einstechtiefe (CDX) hängt von der verwendeten Schneidplatte ab. Zur maximalen Einstechtiefe (CDX) bei verschiedenen Schneidplatten siehe Seite F012–F015.
- \*2 Der maximale Abstechdurchmesser (CUTDIA) hängt von der verwendeten Schneidplatte ab. Der Abstechdurchmesser beträgt das Doppelte der maximalen Einstechtiefe (CDX) der Schneidplatten auf Seite F012–F015.
- \*3 Die dargestellten Abmessungen gelten bei Verwendung von Standard-WSP. Wenn andere WSP-Geometrien verwendet werden, können die Werte für LF, LH, LH2 und WF variieren.

● : Lagerstandard.

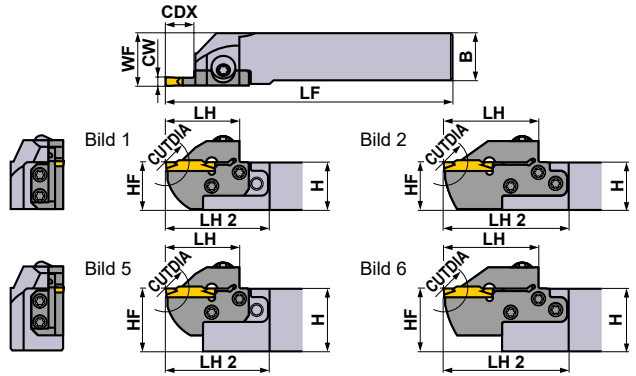
\* Schlüssel : ① : Spannschraube, ② : Schraube für Schwert



Abb. zeigt Rechtsausführung.

ERSATZTEILE			
Halter		5 St.	
	Spannschraube	Schraube für Schwert	Schlüssel*
GYQR/L	HSC05020 (Spannmoment : 7.0N·m)	—	HKY40R
GYHR/L	GY06013M (Spannmoment : 6.0N·m)	TS407 (Spannmoment : 3.5N·m)	①TKY30R ②TKY15D
GYHR/L			TS55 (Spannmoment : 5.0N·m)

Abmessungen (mm) *3								Schnittmodus	
H	B	LF	LH	LH 2	HF	WF	HBH	Uhrzeigersinn	Gegen Uhrzeigersinn
20	20	125	41	—	20	20.35	—	R	
20	20	125	41	—	20	20.35	—		
20	20	119	33	54	20	26	5		
20	20	119	33	54	20	26	5		
25	25	150	41	—	25	25.35	—		
25	25	150	41	—	25	25.35	—		
25	25	144	33	51	25	28	—		
25	25	144	33	51	25	28	—		
32	25	164	33	51	32	28	—		
32	25	164	33	51	32	28	—		
32	32	164	33	51	32	35	—		
32	32	164	33	51	32	35	—		
16	16	110	34	50	16	20	4	L	
16	16	110	34	50	16	20	4		
20	20	125	34	49	20	23	—		
20	20	125	34	49	20	23	—		
20	20	125	39	60	20	26	5		
20	20	125	39	60	20	26	5		
25	25	150	39	57	25	28	—		
25	25	150	39	57	25	28	—		
32	25	170	39	57	32	28	—		
32	25	170	39	57	32	28	—		
32	32	170	39	57	32	35	—		
32	32	170	39	57	32	35	—		
20	20	125	46	—	20	20.35	4		
20	20	125	46	—	20	20.35	4		
20	20	136	50	71	20	26	5		
20	20	136	50	71	20	26	5		
25	25	150	46	—	25	25.35	—		
25	25	150	46	—	25	25.35	—		
25	25	161	50	68	25	28	—		
25	25	161	50	68	25	28	—		
32	25	181	50	68	32	28	—		
32	25	181	50	68	32	28	—		
32	32	181	50	68	32	35	—		
32	32	181	50	68	32	35	—		

WSP-Auswahl

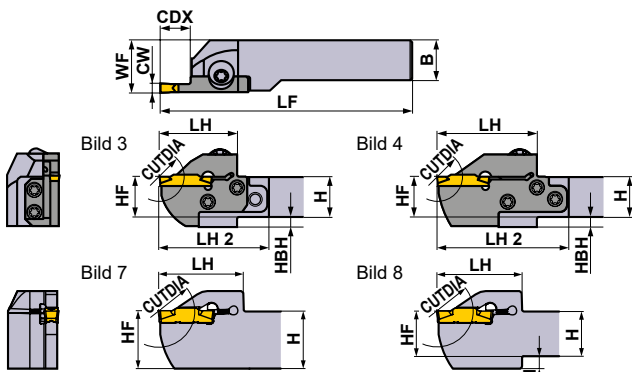
Sitzgröße	Spannbrecher Bezeichnung				
G	GY	0239/0250/0274E	Spannbrecher nachstehend abgebildet		

Spannbrecher zum Einstechen/Abstechen > F012, F013						
Sitzgröße	Spannbrecher	GU	GS	GM	05-GM	GFGS
		Für langsame Sätze	(Keine Vorschläge)	(Mittlere Vorschläge)	(Abstechen)	(Gehärteter Stahl)
	CW	Neutral	Neutral	Neutral	L/R	Neutral
G	4.00mm	●	●	●	●	●

Multifunktionsspannbrecher > F014, F015					
Sitzgröße	Spannbrecher	MF	MS	MM	BM
		(Schichten)	(Keine Vorschläge)	(Mittlere Vorschläge)	(Kopierdrehen, Freistechen)
	CW				Kugelform
G	4.00mm				●
	RE 0.2	●	●	●	
	RE 0.4	●	●	●	
	RE 0.8	●		●	
	4.24mm	●			

● : Standard-WSP mit Abmessungen

IDENTIFIKATION > F008, F009  
 SCHNITTBEDINGUNGEN > F096  
 SICHERHEITSHINWEISE > F100

# GY SERIE (AUSSEN)

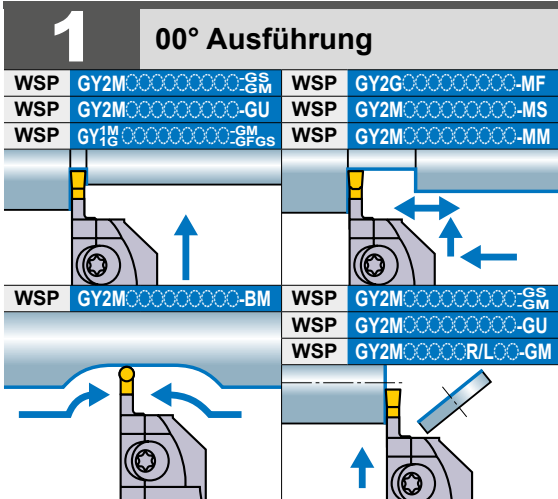

Hinweis 1) Modulare Schwerter und modulare Halter bitte separat bestellen.  
Hinweis 2) Bitte Modul in Rechtsausführung für den Halter in Rechtsausführung und Modul in Linksausführung für den Halter in Linksausführung verwenden.



Abb. zeigt Rechtsausführung.

Sitzgröße	Abmessungen (mm)			Typ	Ausführung (R/L)	Bestellbezeichnung				Bild
	CW	CDX	CUTDIA			Halter	Lager	Modulares Schwert	Lager	
H	4.75 5.00 5.24	8	16	Einteilig	R	GYQR2020K00-H08	●	—	—	7
				L	GYQL2020K00-H08	●	—	—	7	
				Modular	R	GYHR2020K00-M25R	●	GYM25RA-H08	●	3
				L	GYHL2020K00-M25L	●	GYM25LA-H08	●	3	
				Einteilig	R	GYQR2525M00-H08	●	—	—	7
				L	GYQL2525M00-H08	●	—	—	7	
		Modular	R	GYHR2525M00-M25R	●	GYM25RA-H08	●	1		
		L	GYHL2525M00-M25L	●	GYM25LA-H08	●	1			
		Modular	R	GYHR3225P00-M25R	●	GYM25RA-H08	●	5		
		L	GYHL3225P00-M25L	●	GYM25LA-H08	●	5			
		Modular	R	GYHR3232P00-M25R	●	GYM25RA-H08	●	5		
		L	GYHL3232P00-M25L	●	GYM25LA-H08	●	5			
	12	Modular	R	GYHR1616J00-M20R	●	GYM20RA-H12	●	3		
			L	GYHL1616J00-M20L	●	GYM20LA-H12	●	3		
		Modular	R	GYHR2020K00-M20R	●	GYM20RA-H12	●	1		
			L	GYHL2020K00-M20L	●	GYM20LA-H12	●	1		
		14	Modular	R	GYHR2020K00-M25R	●	GYM25RA-H14	●	3	
				L	GYHL2020K00-M25L	●	GYM25LA-H14	●	3	
	Modular		R	GYHR2525M00-M25R	●	GYM25RA-H14	●	1		
			L	GYHL2525M00-M25L	●	GYM25LA-H14	●	1		
	25 *1	Modular	R	GYHR3225P00-M25R	●	GYM25RA-H14	●	5		
			L	GYHL3225P00-M25L	●	GYM25LA-H14	●	5		
		Modular	R	GYHR3232P00-M25R	●	GYM25RA-H14	●	5		
			L	GYHL3232P00-M25L	●	GYM25LA-H14	●	5		
25 *2	Einteilig	R	GYQR2020K00-H25	●	—	—	8			
		L	GYQL2020K00-H25	●	—	—	8			
	Modular	R	GYHR2020K00-M25R	●	GYM25RA-H25	●	4			
		L	GYHL2020K00-M25L	●	GYM25LA-H25	●	4			
	Einteilig	R	GYQR2525M00-H25	●	—	—	7			
		L	GYQL2525M00-H25	●	—	—	7			
Modular	R	GYHR2525M00-M25R	●	GYM25RA-H25	●	2				
	L	GYHL2525M00-M25L	●	GYM25LA-H25	●	2				
Modular	R	GYHR3225P00-M25R	●	GYM25RA-H25	●	6				
	L	GYHL3225P00-M25L	●	GYM25LA-H25	●	6				
Modular	R	GYHR3232P00-M25R	●	GYM25RA-H25	●	6				
	L	GYHL3232P00-M25L	●	GYM25LA-H25	●	6				

\*1 Die maximale Einstechtiefe (CDX) hängt von der verwendeten Schneidplatte ab. Zur maximalen Einstechtiefe (CDX) bei verschiedenen Schneidplatten siehe Seite F012–F015.

\*2 Der maximale Abstechdurchmesser (CUTDIA) hängt von der verwendeten Schneidplatte ab. Der Abstechdurchmesser beträgt das Doppelte der maximalen Einstechtiefe (CDX) der Schneidplatten auf Seite F012–F015.

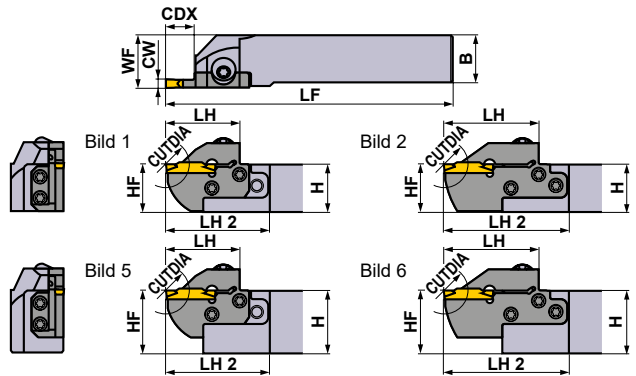
\*3 Die dargestellten Abmessungen gelten bei Verwendung von Standard-WSP. Wenn andere WSP-Geometrien verwendet werden, können die Werte für LF, LH, LH2 und WF variieren.

● : Lagerstandard.





# GY SERIE (AUSSEN)

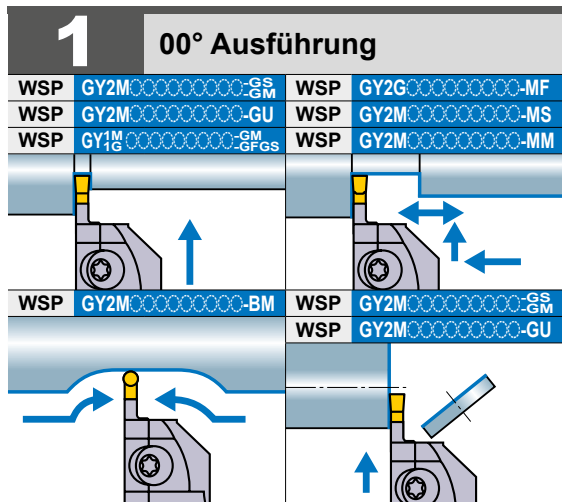

Hinweis 1) Modulare Schwerter und modulare Halter bitte separat bestellen.  
Hinweis 2) Bitte Modul in Rechtsausführung für den Halter in Rechtsausführung und Modul in Linksausführung für den Halter in Linksausführung verwenden.



Abb. zeigt Rechtsausführung.

Sitzgröße	Abmessungen (mm)			Typ	Ausführung (R/L)	Bestellbezeichnung				Bild
	CW	CDX	CUTDIA			Halter	Lager	Modulares Schwert	Lager	
J	6.00 6.31 6.35	8	16	Einteilig	R	GYQR2020K00-J08	●	—	—	7
					L	GYQL2020K00-J08	●	—	—	7
				Modular	R	GYHR2020K00-M25R	●	GYM25RA-J08	●	3
					L	GYHL2020K00-M25L	●	GYM25LA-J08	●	3
				Einteilig	R	GYQR2525M00-J08	●	—	—	7
					L	GYQL2525M00-J08	●	—	—	7
		Modular	R	GYHR2525M00-M25R	●	GYM25RA-J08	●	1		
			L	GYHL2525M00-M25L	●	GYM25LA-J08	●	1		
		Modular	R	GYHR3225P00-M25R	●	GYM25RA-J08	●	5		
			L	GYHL3225P00-M25L	●	GYM25LA-J08	●	5		
		Modular	R	GYHR3232P00-M25R	●	GYM25RA-J08	●	5		
			L	GYHL3232P00-M25L	●	GYM25LA-J08	●	5		
		14	28	Modular	R	GYHR2020K00-M25R	●	GYM25RA-J14	●	3
				L	GYHL2020K00-M25L	●	GYM25LA-J14	●	3	
	Modular			R	GYHR2525M00-M25R	●	GYM25RA-J14	●	1	
				L	GYHL2525M00-M25L	●	GYM25LA-J14	●	1	
	Modular			R	GYHR3225P00-M25R	●	GYM25RA-J14	●	5	
				L	GYHL3225P00-M25L	●	GYM25LA-J14	●	5	
		25 *1	50 *2	Einteilig	R	GYQR2020K00-J25	●	—	—	8
				L	GYQL2020K00-J25	●	—	—	8	
	Modular			R	GYHR2020K00-M25R	●	GYM25RA-J25	●	4	
				L	GYHL2020K00-M25L	●	GYM25LA-J25	●	4	
	Einteilig			R	GYQR2525M00-J25	●	—	—	7	
				L	GYQL2525M00-J25	●	—	—	7	
Modular	R	GYHR2525M00-M25R	●	GYM25RA-J25	●	2				
	L	GYHL2525M00-M25L	●	GYM25LA-J25	●	2				
Modular	R	GYHR3225P00-M25R	●	GYM25RA-J25	●	6				
	L	GYHL3225P00-M25L	●	GYM25LA-J25	●	6				
Modular	R	GYHR3232P00-M25R	●	GYM25RA-J25	●	6				
	L	GYHL3232P00-M25L	●	GYM25LA-J25	●	6				

\*1 Die maximale Einstechtiefe (CDX) hängt von der verwendeten Schneidplatte ab. Zur maximalen Einstechtiefe (CDX) bei verschiedenen Schneidplatten siehe Seite F012–F015.  
\*2 Der maximale Abstechdurchmesser (CUTDIA) hängt von der verwendeten Schneidplatte ab. Der Abstechdurchmesser beträgt das Doppelte der maximalen Einstechtiefe (CDX) der Schneidplatten auf Seite F012–F015.  
\*3 Die dargestellten Abmessungen gelten bei Verwendung von Standard-WSP. Wenn andere WSP-Geometrien verwendet werden, können die Werte für LF, LH, LH2 und WF variieren.

● : Lagerstandard.

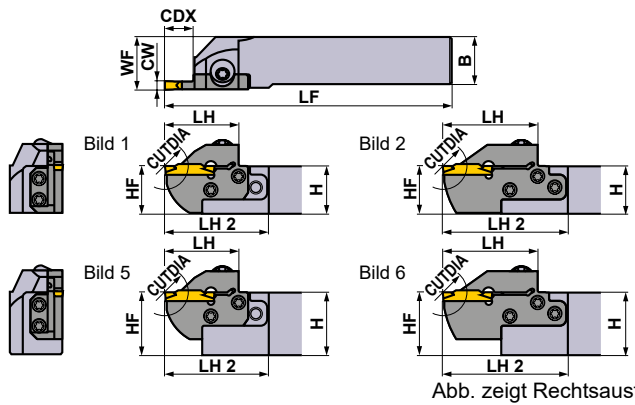
EINSTECHEN / ABSTECHEN













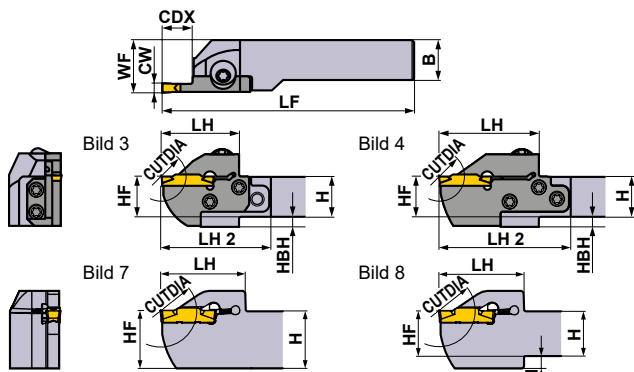

Abb. zeigt Rechtsausführung.

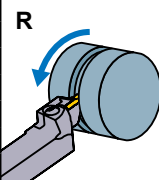
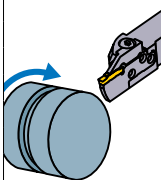
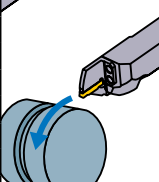
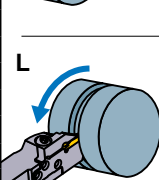
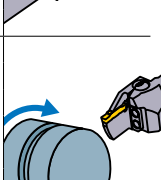
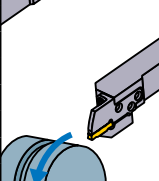
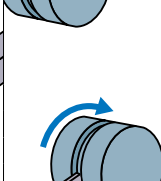
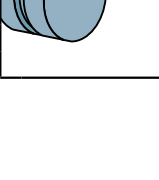
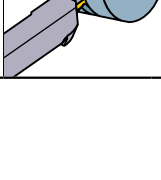
\* Schlüssel : ① : Spannschraube, ② : Schraube für Schwert

### ERSATZTEILE

Halter		 5 St.	
GYQR/L	HSC05020 (Spannmoment : 7.0N·m)	—	HKY40R
GYHR/L	GY06013M (Spannmoment : 6.0N·m)	TS55 (Spannmoment : 5.0N·m)	①TKY30R ②TKY25D

Abmessungen (mm) *3								Schnittmodus	
H	B	LF	LH	LH 2	HF	WF	HBH	Uhrzeigersinn	Gegen Uhrzeigersinn
20	20	125	41	—	20	20.35	—	R	
20	20	125	41	—	20	20.35	—		
20	20	119	33	54	20	26	5		
20	20	119	33	54	20	26	5		
25	25	150	41	—	25	25.35	—		
25	25	150	41	—	25	25.35	—		
25	25	144	33	51	25	28	—		
25	25	144	33	51	25	28	—		
32	25	164	33	51	32	28	—		
32	25	164	33	51	32	28	—		
32	32	164	33	51	32	35	—		
32	32	164	33	51	32	35	—		
20	20	125	39	60	20	26	5		
20	20	125	39	60	20	26	5		
25	25	150	39	57	25	28	—		
25	25	150	39	57	25	28	—		
32	25	170	39	57	32	28	—		
32	25	170	39	57	32	28	—		
32	32	170	39	57	32	35	—		
32	32	170	39	57	32	35	—		
20	20	125	46	—	20	20.35	4		
20	20	125	46	—	20	20.35	4		
20	20	136	50	71	20	26	5		
20	20	136	50	71	20	26	5		
25	25	150	46	—	25	25.35	—		
25	25	150	46	—	25	25.35	—		
25	25	161	50	68	25	28	—		
25	25	161	50	68	25	28	—		
32	25	181	50	68	32	28	—		
32	25	181	50	68	32	28	—		
32	32	181	50	68	32	35	—		
32	32	181	50	68	32	35	—		

### WSP-Auswahl

Sitzgröße	<b>Spannbrecher Bezeichnung</b>
J	GY00600/0631/0635J

### Spannbrecher zum Einstechen/Abstechen > F012, F013

Sitzgröße	Spannbrecher	GU	GS	GM	05-GM	GFGS
		(Für längere Stäbe)	(Keine Vorschübe)	(Mittlere Vorschübe)	(Abstechen)	(Geleiteter Start)
J	6.00mm	●	●	●	●	●
	6.35mm	●	●	●	●	●

### Multifunktionsspannbrecher > F014, F015

Sitzgröße	Spannbrecher	MF	MS	MM	BM
		(Schlichten)	(Keine Vorschübe)	(Mittlere Vorschübe)	(Kopierdrehen, Freistechen)
J	6.00mm	●	●	●	●
	RE 0.2	●	●	●	●
	RE 0.4	●	●	●	●
	RE 0.8	●	●	●	●
	6.31mm	●	●	●	●
	6.35mm	●	●	●	●

● : Standard-WSP mit Abmessungen

IDENTIFIKATION > F008, F009  
 SCHNITTBEDINGUNGEN > F096  
 SICHERHEITSHINWEISE > F100

## GY SERIE (AUSSEN)



Abb. zeigt Rechtsausführung.

Sitzgröße	Abmessungen (mm)			Typ	Ausführung (R/L)	Bestellbezeichnung				Bild
	CW	CDX	CUTDIA			Halter	Lager	Modulares Schwert	Lager	
K	8.00	25 *1	50 *2	Einteilig	R	GYPR2525M00-K25	●	—	—	1
					L	GYPL2525M00-K25	●	—	—	1
				Einteilig	R	GYPR3225P00-K25	●	—	—	2
					L	GYPL3225P00-K25	●	—	—	2
				Einteilig	R	GYPR3232P00-K25	●	—	—	3
					L	GYPL3232P00-K25	●	—	—	3

\*1 Die maximale Einstechtiefe (CDX) hängt von der verwendeten Schneidplatte ab. Zur maximalen Einstechtiefe (CDX) bei verschiedenen Schneidplatten siehe Seite F012—F015.

\*2 Der maximale Abstechdurchmesser (CUTDIA) hängt von der verwendeten Schneidplatte ab. Der Abstechdurchmesser beträgt das Doppelte der maximalen Einstechtiefe (CDX) der Schneidplatten auf Seite F012—F015.

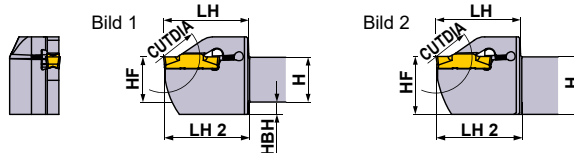
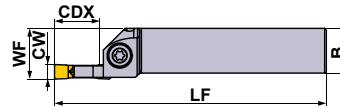
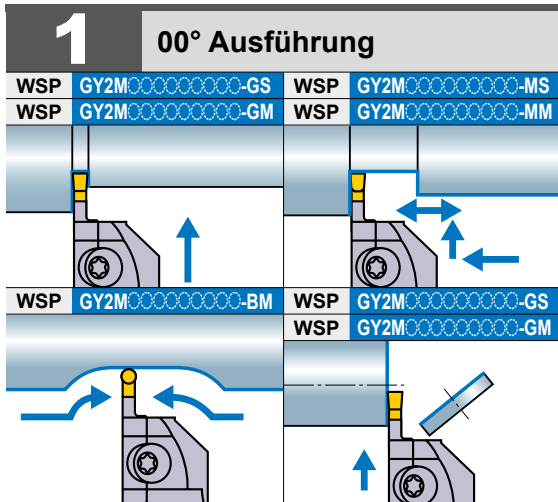
\*3 Die dargestellten Abmessungen gelten bei Verwendung von Standard-WSP. Wenn andere WSP-Geometrien verwendet werden, können die Werte für LF, LH, LH2 und WF variieren.

● : Lagerstandard.



Abb. zeigt Rechtsausführung.

ERSATZTEILE		
Halter		
	Spannschraube	Schlüssel
<b>GYPR/L</b> 00-K25	GY06013M (Spannmoment : 6.0N·m)	TKY30R

	Abmessungen (mm) *3								Schnittmodus	
	H	B	LF	LH	LH 2	HF	WF	HBH	Uhrzeigersinn	Gegen Uhrzeigersinn
	25	25	150	47	48	25	28	7	<b>R</b>	
	25	25	150	47	48	25	28	7		
	32	25	170	47	48	32	28	—	<b>L</b>	
	32	25	170	47	48	32	28	—		
	32	32	170	47	48	32	35	—	<b>L</b>	
	32	32	170	47	48	32	35	—		

**WSP-Auswahl**

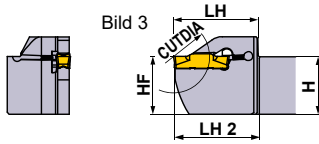
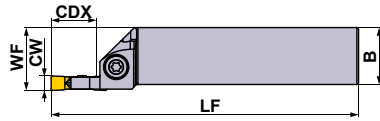
Sitzgröße	<b>Spannbrecher Bezeichnung</b>
<b>K</b>	GY0800K—Spannbrecher nachstehend abgebildet

Spannbrecher zum Einstechen/Abstechen > F012, F013						
Sitzgröße	Spannbrecher	GU	GS	GM	05-GM	GFGS
		(Für langspanne Sitze)	(Keine Vorschläge)	(Mittlere Vorschläge)	(Abstechen)	(Gehärteter Stahl)
<b>CW</b>	Neutral	Neutral	Neutral	L/R	Neutral	
<b>K</b>	8.00mm		●	●		

Multifunktionspannbrecher > F014, F015					
Sitzgröße	Spannbrecher	MF	MS	MM	BM
		(Schichten)	(Keine Vorschläge)	(Mittlere Vorschläge)	(Kopierdrehen, Freistechen)
<b>CW</b>	8.00mm				Kugelform
<b>K</b>	RE 0.8		●	●	●
	RE 1.2			●	

● : Standard-WSP mit Abmessungen

EINSTECHEN / ABSTECHEN

# GY SERIE (AUSSEN)

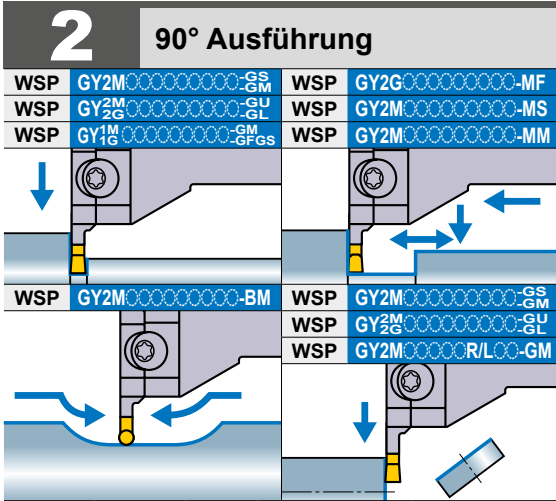

Hinweis 1) Modulare Schwerter und modulare Halter bitte separat bestellen.  
 Hinweis 2) Bitte Modul in Linksausführung für den Halter in Rechtsausführung und Modul in Rechtsausführung für den Halter in Linksausführung verwenden.







Abb. zeigt Rechtsausführung.

Sitzgröße	Abmessungen (mm)			Typ	Ausführung (R/L)	Bestellbezeichnung				Bild
	CW	CDX	CUTDIA			Halter	Lager	Modulares Schwert	Lager	
D	2.00 2.24	6	12	Modular	R	GYHR2020K90-M20L	●	GYM20LA-D06	●	1
				Modular	L	GYHL2020K90-M20R	●	GYM20RA-D06	●	1
		10	20	Modular	R	GYHR2525M90-M25L	●	GYM25LA-D06	●	1
				Modular	L	GYHL2525M90-M25R	●	GYM25RA-D06	●	1
		12	24	Modular	R	GYHR2020K90-M20L	●	GYM20LA-D10	●	1
				Modular	L	GYHL2020K90-M20R	●	GYM20RA-D10	●	1
		18 *4	36	Modular	R	GYHR2525M90-M25L	●	GYM25LA-D12	●	1
				Modular	L	GYHL2525M90-M25R	●	GYM25RA-D12	●	1
		20 *1	40 *2	Modular	R	GYHR2020K90-M20L	●	GYM20LB-D18	●	2
				Modular	L	GYHL2020K90-M20R	●	GYM20RB-D18	●	2
E	2.39 2.50 2.74	6	12	Modular	R	GYHR2020K90-M20L	●	GYM20LA-E06	●	1
				Modular	L	GYHL2020K90-M20R	●	GYM20RA-E06	●	1
		10	20	Modular	R	GYHR2525M90-M25L	●	GYM25LA-E06	●	1
				Modular	L	GYHL2525M90-M25R	●	GYM25RA-E06	●	1
		12	24	Modular	R	GYHR2020K90-M20L	●	GYM20LA-E10	●	1
				Modular	L	GYHL2020K90-M20R	●	GYM20RA-E10	●	1
		18 *4	36	Modular	R	GYHR2525M90-M25L	●	GYM25LA-E12	●	1
				Modular	L	GYHL2525M90-M25R	●	GYM25RA-E12	●	1
		20 *1	40 *2	Modular	R	GYHR2020K90-M20L	●	GYM20LB-E18	●	2
				Modular	L	GYHL2020K90-M20R	●	GYM20RB-E18	●	2
				Modular	R	GYHR2525M90-M25L	●	GYM25LA-E20	●	2
				Modular	L	GYHL2525M90-M25R	●	GYM25RA-E20	●	2

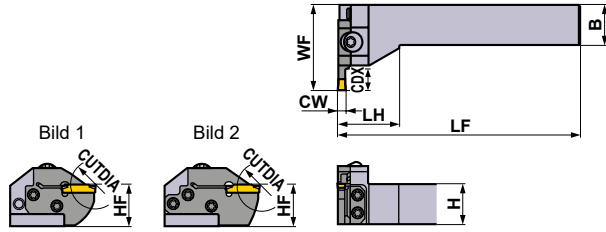
- \*1 Die maximale Einstechtiefe (CDX) hängt von der verwendeten Schneidplatte ab. Zur maximalen Einstechtiefe (CDX) bei verschiedenen Schneidplatten siehe Seite F012–F015.
- \*2 Der maximale Abstechdurchmesser (CUTDIA) hängt von der verwendeten Schneidplatte ab. Der Abstechdurchmesser beträgt das Doppelte der maximalen Einstechtiefe (CDX) der Schneidplatten auf Seite F012–F015.
- \*3 Die dargestellten Abmessungen gelten bei der Verwendung von Standard-WSP. Wenn andere WSP-Geometrien verwendet werden, können die Werte für LF, LH und WF variieren.
- \*4 Die maximale Einstechtiefe (CDX) ist durch den Werkstückdurchmesser begrenzt. Siehe Seite F098 für weitere Hinweise.

● : Lagerstandard.

\* Schlüssel : ① : Spannschraube, ② : Schraube für Schwert

ERSATZTEILE			
Halter		 5 St.	
	Spannschraube	Schraube für Schwert	Schlüssel*
<b>GYHR2020K90-M20L</b>	GY06013M (Spannmoment : 6.0N·m)	TS407 (Spannmoment : 3.5N·m)	①TKY30R
<b>GYHL2020K90-M20R</b>			②TKY15D
<b>GYHR2525M90-M25L</b>		TS55 (Spannmoment : 5.0N·m)	①TKY30R
<b>GYHL2525M90-M25R</b>			②TKY25D

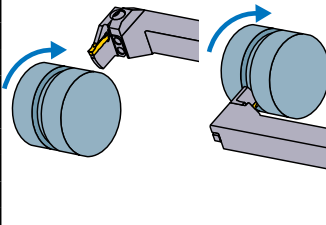
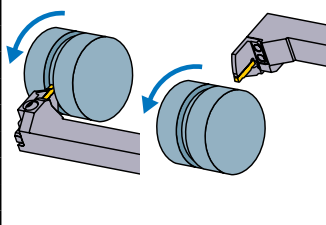
	Abmessungen (mm) *3						Schnittmodus
	H	B	LF	LH	HF	WF	
	20	20	125	35	20	39	<b>R</b> 
	20	20	125	35	20	39	
	25	25	150	38	25	45	
	25	25	150	38	25	45	
	20	20	125	35	20	45	
	20	20	125	35	20	45	
	25	25	150	38	25	53	
	25	25	150	38	25	53	
	20	20	125	35	20	51	
	20	20	125	35	20	51	
	25	25	150	38	25	59	<b>L</b> 
	25	25	150	38	25	59	
	20	20	125	35	20	39	
	20	20	125	35	20	39	
	25	25	150	38	25	45	
	25	25	150	38	25	45	
	20	20	125	35	20	45	
	20	20	125	35	20	45	
	25	25	150	38	25	53	
	25	25	150	38	25	53	
	20	20	125	35	20	51	
	20	20	125	35	20	51	
	25	25	150	38	25	59	
	25	25	150	38	25	59	

### WSP-Auswahl

Sitzgröße	Spannbrecher Bezeichnung
D	GY○○0200/0224D○○○○○—Spannbrecher nachstehend abgebildet
E	GY○○0239/0250/0274E○○○○○—Spannbrecher nachstehend abgebildet

Spannbrecher zum Einstechen/Abstechen > F012, F013							
Sitzgröße	Spannbrecher	GU	GS	GM	GL	05-GM	GFGS
		(Für langsamere Stahl)	(Kleine Vorschübe)	(Mittlere Vorschübe)	(Aluminiumlegierung)	(Abstechen)	(Gehärteter Stahl)
	CW	Neutral	Neutral	Neutral	Neutral	L/R	Neutral
D	2.00mm	●	●	●	●	●	●
E	2.39mm	●	●	●	●	●	●
	2.50mm	●	●	●	●	●	●

Multifunktionsspannbrecher > F014, F015					
Sitzgröße	Spannbrecher	MF	MS	MM	BM
		(Schichten)	(Kleine Vorschübe)	(Mittlere Vorschübe)	(Kopierdrehen, Freistechen)
	CW				Kugelform
D	2.00mm	●	●	●	●
	2.24mm	●			
	2.39mm	●			
E	2.50mm	●	●	●	●
	2.74mm	●			

● : Standard-WSP mit Abmessungen

T

EINSTECHEN / ABSTECHE

IDENTIFIKATION > F008, F009  
 SCHNITTBEDINGUNGEN > F096  
 SICHERHEITSHINWEISE > F100

## GY SERIE (AUSSEN)

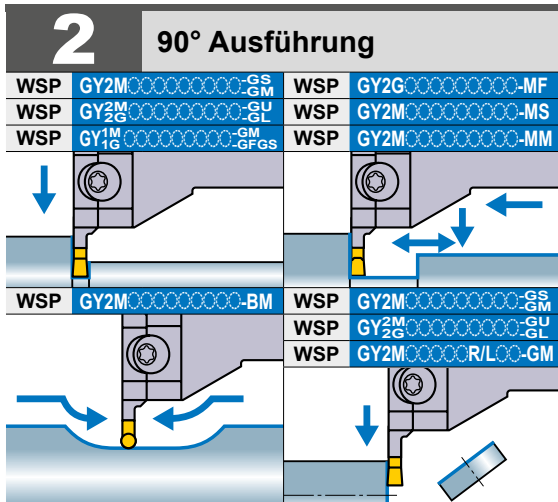

Hinweis 1) Modulare Schwerter und modulare Halter bitte separat bestellen.  
Hinweis 2) Spitze Modul in Linksausführung für den Halter in Rechtsausführung und Modul in Rechtsausführung für den Halter in Linksausführung verwenden.







Abb. zeigt Rechtsausführung.

Sitzgröße	Abmessungen (mm)			Typ	Ausführung (R/L)	Bestellbezeichnung				Bild
	CW	CDX	CUTDIA			Halter	Lager	Modulares Schwert	Lager	
F	3.00 3.18 3.24	6	12	Modular	R	GYHR2020K90-M20L	●	GYM20LA-F06	●	1
				L	GYHL2020K90-M20R	●	GYM20RA-F06	●	1	
		10	20	Modular	R	GYHR2525M90-M25L	●	GYM25LA-F06	●	1
				L	GYHL2525M90-M25R	●	GYM25RA-F06	●	1	
		12	24	Modular	R	GYHR2020K90-M20L	●	GYM20LA-F10	●	1
				L	GYHL2020K90-M20R	●	GYM20RA-F10	●	1	
18 *4	36	Modular	R	GYHR2525M90-M25L	●	GYM25LA-F12	●	1		
		L	GYHL2525M90-M25R	●	GYM25RA-F12	●	1			
G	4.00 4.24	8	16	Modular	R	GYHR2020K90-M20L	●	GYM20LB-F18	●	2
				L	GYHL2020K90-M20R	●	GYM20RB-F18	●	2	
		12	24	Modular	R	GYHR2525M90-M25L	●	GYM25LA-F20	●	2
				L	GYHL2525M90-M25R	●	GYM25RA-F20	●	2	
14	28	Modular	R	GYHR2020K90-M20L	●	GYM20LA-G08	●	1		
		L	GYHL2020K90-M20R	●	GYM20RA-G08	●	1			
25 *1	50 *2	Modular	R	GYHR2020K90-M20L	●	GYM20LA-G12	●	1		
		L	GYHL2020K90-M20R	●	GYM20RA-G12	●	1			
25 *1	50 *2	Modular	R	GYHR2525M90-M25L	●	GYM25LA-G14	●	1		
		L	GYHL2525M90-M25R	●	GYM25RA-G14	●	1			
25 *1	50 *2	Modular	R	GYHR2525M90-M25L	●	GYM25LA-G25	●	2		
		L	GYHL2525M90-M25R	●	GYM25RA-G25	●	2			

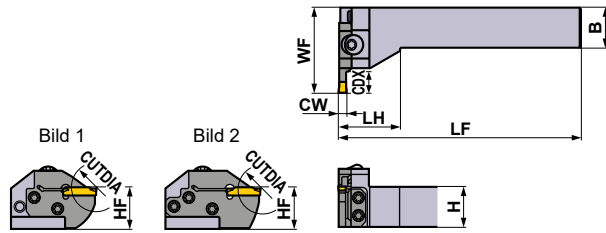
- \*1 Die maximale Einstechtiefe (CDX) hängt von der verwendeten Schneidplatte ab. Zur maximalen Einstechtiefe (CDX) bei verschiedenen Schneidplatten siehe Seite F012–F015.
- \*2 Der maximale Abstechdurchmesser (CUTDIA) hängt von der verwendeten Schneidplatte ab. Der Abstechdurchmesser beträgt das Doppelte der maximalen Einstechtiefe (CDX) der Schneidplatten auf Seite F012–F015.
- \*3 Die dargestellten Abmessungen gelten bei der Verwendung von Standard-WSP. Wenn andere WSP-Geometrien verwendet werden, können die Werte für LF, LH und WF variieren.
- \*4 Die maximale Einstechtiefe (CDX) ist durch den Werkstückdurchmesser begrenzt. Siehe Seite F098 für weitere Hinweise.

● : Lagerstandard.

\* Schlüssel : ① : Spannschraube, ② : Schraube für Schwert

ERSATZTEILE			
Halter		 5 St.	
	Spannschraube	Schraube für Schwert	Schlüssel*
<b>GYHR2020K90-M20L</b>	GY06013M (Spannmoment : 6.0N·m)	TS407 (Spannmoment : 3.5N·m)	①TKY30R
<b>GYHL2020K90-M20R</b>			②TKY15D
<b>GYHR2525M90-M25L</b>		TS55 (Spannmoment : 5.0N·m)	①TKY30R
<b>GYHL2525M90-M25R</b>			②TKY25D

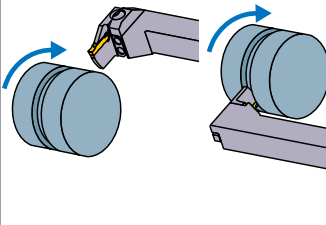
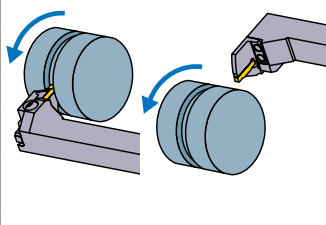
	Abmessungen (mm) *3						Schnittmodus
	H	B	LF	LH	HF	WF	
	20	20	125	35	20	39	<b>R</b> 
	20	20	125	35	20	39	
	25	25	150	38	25	45	
	25	25	150	38	25	45	
	20	20	125	35	20	45	
	20	20	125	35	20	45	
	25	25	150	38	25	53	
	25	25	150	38	25	53	
	20	20	125	35	20	51	
	20	20	125	35	20	51	
	25	25	150	38	25	59	<b>L</b> 
	25	25	150	38	25	59	
	25	25	150	38	25	47	
	25	25	150	38	25	47	
	20	20	125	35	20	45	
	20	20	125	35	20	45	
	25	25	150	38	25	53	
	25	25	150	38	25	53	
	25	25	150	38	25	64	
	25	25	150	38	25	64	

### WSP-Auswahl

Sitzgröße	Spannbrecher Bezeichnung
F	GY <span style="border: 1px solid black; border-radius: 50%; padding: 2px;">0300/0318/0324</span> F <span style="border: 1px solid black; border-radius: 50%; padding: 2px;">0000</span> - Spannbrecher nachstehend abgebildet
G	GY <span style="border: 1px solid black; border-radius: 50%; padding: 2px;">0400/0424</span> G <span style="border: 1px solid black; border-radius: 50%; padding: 2px;">0000</span> - Spannbrecher nachstehend abgebildet

Spannbrecher zum Einstechen/Abstechen > F012, F013						
Sitzgröße	Spannbrecher	GU	GS	GM	GL	GFGS
		(Für langspannende Stahl)	(Kleine Vorschübe)	(Mittlere Vorschübe)	(Aluminiumlegierung)	(Gehärteter Stahl)
	CW	Neutral	Neutral	Neutral	Neutral	L/R Neutral
F	3.00mm	●	●	●	●	●
	3.18mm	●	●	●	●	●
G	4.00mm	●	●	●	●	●

Multifunktionsspannbrecher > F014, F015					
Sitzgröße	Spannbrecher	MF	MS	MM	BM
		(Schichten)	(Kleine Vorschübe)	(Mittlere Vorschübe)	(Kopierdrehen, Freistechen)
F	3.00mm				●
	RE 0.2	●	●	●	
	RE 0.4	●	●	●	
	RE 0.8			●	
	3.18mm				●
	RE 0.2	●			
G	3.24mm	●			
	4.00mm				●
	RE 0.2	●	●	●	
	RE 0.4	●	●	●	
	RE 0.8	●		●	
4.24mm	●				

● : Standard-WSP mit Abmessungen

IDENTIFIKATION > F008, F009  
 SCHNITTBEDINGUNGEN > F096  
 SICHERHEITSHINWEISE > F100



# GY SERIE (AUSSEN)

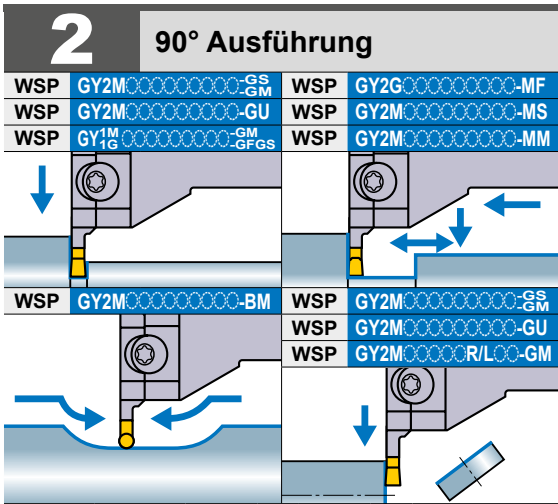

Hinweis 1) Modulare Schwerter und modulare Halter bitte separat bestellen.  
 Hinweis 2) Bitte Modul in Linksausführung für den Halter in Rechtsausführung und Modul in Rechtsausführung für den Halter in Linksausführung verwenden.







Abb. zeigt Rechtsausführung.

Sitzgröße	Abmessungen (mm)			Typ	Ausführung (R/L)	Bestellbezeichnung				Bild	
	CW	CDX	CUTDIA			Halter	Lager	Modulares Schwert	Lager		
H	4.75 5.00 5.24	8	16	Modular	R L	GYHR2525M90-M25L GYHL2525M90-M25R	● ●	GYM25LA-H08 GYM25RA-H08	● ●	1 1	
		12	24	Modular	R L	GYHR2020K90-M20L GYHL2020K90-M20R	● ●	GYM20LA-H12 GYM20RA-H12	● ●	1 1	
		14	28	Modular	R L	GYHR2525M90-M25L GYHL2525M90-M25R	● ●	GYM25LA-H14 GYM25RA-H14	● ●	1 1	
		25 *1	50 *2	Modular	R L	GYHR2525M90-M25L GYHL2525M90-M25R	● ●	GYM25LA-H25 GYM25RA-H25	● ●	2 2	
J	6.00 6.31 6.35	8	16	Modular	R L	GYHR2525M90-M25L GYHL2525M90-M25R	● ●	GYM25LA-J08 GYM25RA-J08	● ●	1 1	
		14	28	Modular	R L	GYHR2525M90-M25L GYHL2525M90-M25R	● ●	GYM25LA-J14 GYM25RA-J14	● ●	1 1	
		25 *1	50 *2	Modular	R L	GYHR2525M90-M25L GYHL2525M90-M25R	● ●	GYM25LA-J25 GYM25RA-J25	● ●	2 2	

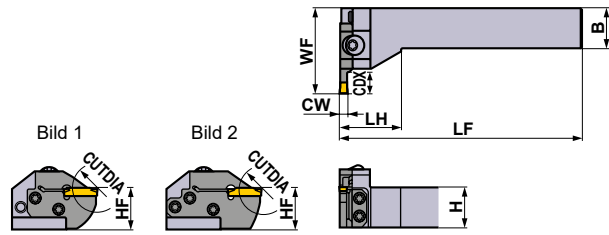
- \*1 Die maximale Einstechtiefe (CDX) hängt von der verwendeten Schneidplatte ab. Zur maximalen Einstechtiefe (CDX) bei verschiedenen Schneidplatten siehe Seite F012–F015.
- \*2 Der maximale Abstechedurchmesser (CUTDIA) hängt von der verwendeten Schneidplatte ab. Der Abstechedurchmesser beträgt das Doppelte der maximalen Einstechtiefe (CDX) der Schneidplatten auf Seite F012–F015.
- \*3 Die dargestellten Abmessungen gelten bei der Verwendung von Standard-WSP. Wenn andere WSP-Geometrien verwendet werden, können die Werte für LF, LH und WF variieren.

● : Lagerstandard.

\* Schlüssel : ① : Spannschraube, ② : Schraube für Schwert

ERSATZTEILE			
Halter		 5 St.	
	Spannschraube	Schraube für Schwert	Schlüssel*
<b>GYHR2020K90-M20L</b>	GY06013M (Spannmoment : 6.0N·m)	TS407 (Spannmoment : 3.5N·m)	①TKY30R
<b>GYHL2020K90-M20R</b>			②TKY15D
<b>GYHR2525M90-M25L</b>		TS55 (Spannmoment : 5.0N·m)	①TKY30R
<b>GYHL2525M90-M25R</b>			②TKY25D

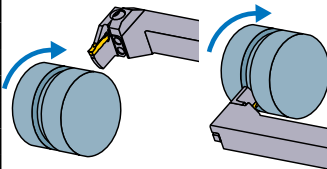
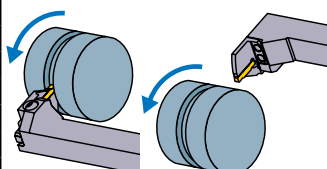
	Abmessungen (mm) *3						Schnittmodus
	H	B	LF	LH	HF	WF	
	25	25	150	38	25	47	<b>R</b> 
	25	25	150	38	25	47	
	20	20	125	35	20	45	
	20	20	125	35	20	45	
	25	25	150	38	25	53	
	25	25	150	38	25	53	
	25	25	150	38	25	64	<b>L</b> 
	25	25	150	38	25	64	
	25	25	150	38	25	53	
	25	25	150	38	25	53	
	25	25	150	38	25	64	
	25	25	150	38	25	64	

### WSP-Auswahl

Sitzgröße	Spannbrecher Bezeichnung
H	GY○○0475/0500/0524H○○○○○ Spannbrecher nachstehend abgebildet
J	GY○○0600/0631/0635J○○○○○ Spannbrecher nachstehend abgebildet

Spannbrecher zum Einstecken/Abstechen > F012, F013						
Sitzgröße	Spannbrecher	GU	GS	GM	05-GM	GFGS
		(Für angrenzende Stäbe)	(Keine Vorsätze)	(Mittlere Vorsätze)	(Abstechen)	(Gehärteter Stahl)
H	CW	Neutral	Neutral	Neutral	L/R	Neutral
	4.75mm	●	●	●	●	●
	5.00mm	●	●	●	●	●
J	6.00mm	●	●	●	●	●
	6.35mm	●	●	●	●	●

Multifunktionsspannbrecher > F014, F015					
Sitzgröße	Spannbrecher	MF	MS	MM	BM
		(Schichten)	(Keine Vorsätze)	(Mittlere Vorsätze)	(Kopierdrehen, Freisteichen)
H	CW				Kugelform
	4.75mm				●
	RE 0.2	●			
	RE 0.4	●			
	RE 0.8	●			
	5.00mm				●
J	RE 0.2	●		●	
	RE 0.4	●	●	●	
	RE 0.8	●	●	●	
	6.00mm				●
	RE 0.2	●			
	RE 0.4	●			
	RE 0.8	●			
	6.31mm				●
	6.35mm				●
RE 0.2	●				
RE 0.4	●				
RE 0.8	●				

● : Standard-WSP mit Abmessungen

IDENTIFIKATION > F008, F009  
 SCHNITTBEDINGUNGEN > F096  
 SICHERHEITSHINWEISE > F100

## GY SERIE (ZUM AUSSENEINSTECHEN)

### 3

### Für 50°-Einstechhalter

Hinweis 1) Modulare Schwerter und modulare Halter bitte separat bestellen.  
Hinweis 2) Spitze Modul in Linksausführung für den Halter in Rechtsausführung und Modul in Rechtsausführung für den Halter in Linksausführung verwenden.

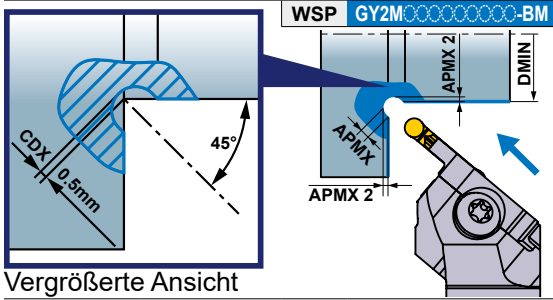

Vergrößerte Ansicht



Abb. zeigt Rechtsausführung.



Sitzgröße	Abmessungen (mm)					Typ	Ausführung (R/L)	Bestellbezeichnung				Bild
	CW	CDX	DMIN	APMX	APMX 2			Halter	Lager	Modulares Schwert	Lager	
D	2.00	0.5	30	1.5	0.646	Modular	R	GYHR2020K50-M20L	●	GYM20LC-D005	●	1
						Modular	L	GYHL2020K50-M20R	●	GYM20RC-D005	●	1
E	2.50			1.75	0.72	Modular	R	GYHR2525M50-M25L	●	GYM25LC-D005	●	1
						Modular	L	GYHL2525M50-M25R	●	GYM25RC-D005	●	1
F	3.00			2	0.793	Modular	R	GYHR2020K50-M20L	●	GYM20LC-E005	●	1
						Modular	L	GYHL2020K50-M20R	●	GYM20RC-E005	●	1
	3.18			Modular	R	GYHR2525M50-M25L	●	GYM25LC-E005	●	1		
				Modular	L	GYHL2525M50-M25R	●	GYM25RC-E005	●	1		
G	4.00			2.5	0.939	Modular	R	GYHR2020K50-M20L	●	GYM20LC-F005	●	1
						Modular	L	GYHL2020K50-M20R	●	GYM20RC-F005	●	1
H	4.75	2.88	1.049	Modular	R	GYHR2525M50-M25L	●	GYM25LC-F005	●	1		
				Modular	L	GYHL2525M50-M25R	●	GYM25RC-F005	●	1		
	5.00	Modular	R	GYHR2020K50-M20L	●	GYM20LC-G005	●	1				
		Modular	L	GYHL2020K50-M20R	●	GYM20RC-G005	●	1				
J	6.00	3.5	1.232	Modular	R	GYHR2525M50-M25L	●	GYM25LC-G005	●	1		
				Modular	L	GYHL2525M50-M25R	●	GYM25RC-G005	●	1		
	6.35											

\*1 Das Schwert für Außeneinstechen und Axialeinstechen kann aufgrund von Kollision mit dem Werkstück nicht verwendet werden.

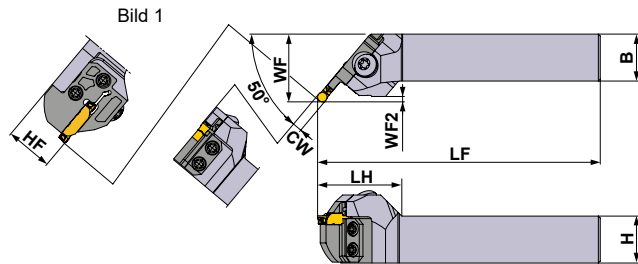
\*2 Die dargestellten Abmessungen gelten bei der Verwendung von Standard-WSP. Wenn andere WSP-Geometrien verwendet werden, können die Werte für LF, LH, WF und WF2 variieren.

● : Lagerstandard.

\* Schlüssel : ① : Spannschraube, ② : Schraube für Schwert

ERSATZTEILE			
Halter		 4 St.	
	Spannschraube	Schraube für Schwert	Schlüssel*
GYHR/L2020K50-M20R/L	GY06013M (Spannmoment : 6.0N·m)	TS407 (Spannmoment : 3.5N·m)	①TKY30R ②TKY25D
GYHR/L2525M50-M25R/L		TS55 (Spannmoment : 5.0N·m)	①TKY30R ②TKY25D

	Abmessungen (mm) *2						
	H	B	LF	LH	HF	WF	WF2
	20	20	125	40	20	32	1.6
	20	20	125	40	20	32	1.6
	25	25	150	45	25	35	1.6
	25	25	150	45	25	35	1.6
	20	20	125	40	20	32	1.8
	20	20	125	40	20	32	1.8
	25	25	150	45	25	35	1.8
	25	25	150	45	25	35	1.8
	20	20	125	40	20	32	2.0
	20	20	125	40	20	32	2.0
	25	25	150	45	25	35	2.0
	25	25	150	45	25	35	2.0
	20	20	125	40	20	32	2.4
	20	20	125	40	20	32	2.4
	25	25	150	45	25	35	2.4
	25	25	150	45	25	35	2.4
	20	20	125	40	20	33	2.8
	20	20	125	40	20	33	2.8
	25	25	150	45	25	36	2.8
	25	25	150	45	25	36	2.8
	25	25	150	44	25	36	3.4
	25	25	150	44	25	36	3.4

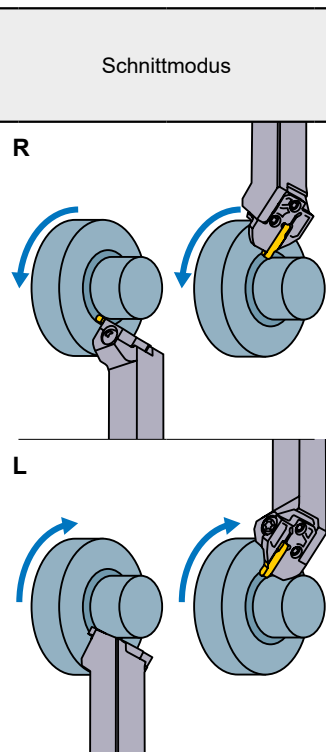

### WSP-Auswahl

#### Spanbrecher Bezeichnung

GY2M:○○○○○○○○○N-BM

#### Multifunktionsspanbrecher > F015

Sitzgröße	Spanbrecher CW	BM (Kopierdrehen, Freistechen)	
		Kugelform	
D	2.00mm	●	●
E	2.50mm	●	●
F	3.00mm	●	●
	3.18mm	●	●
G	4.00mm	●	●
H	4.75mm	●	●
	5.00mm	●	●
J	6.00mm	●	●
	6.35mm	●	●

● : Standard-WSP mit Abmessungen

IDENTIFIKATION > F008, F009  
 SCHNITTBEDINGUNGEN > F099  
 SICHERHEITSHINWEISE > F099

## GY SERIE (AXIALEINSTECHEN)

### 4

### 00° Ausführung

Hinweis 1) Modulare Schwerter und modulare Halter bitte separat bestellen.  
Hinweis 2) Spitze Modul in Rechtsausführung für den Halter in Rechtsausführung und Modul in Linksausführung für den Halter in Linksausführung verwenden.

WSP	GY2M <sup>GS</sup>	WSP	GY2G <sup>MF</sup>
WSP	GY2M <sup>GU</sup>	WSP	GY2M <sup>MS</sup>
WSP	GY1 <sup>GM</sup>	WSP	GY2M <sup>MM</sup>

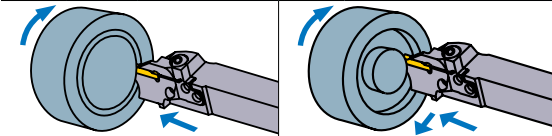

WSP GY2M<sup>BM</sup>



Abb. zeigt Rechtsausführung.

Sitzgröße	Abmessungen (mm)				Typ	Ausführung (R/L)	Bestellbezeichnung				Bild
	CW	DAXN	DAXX	CDX			Halter	Lager	Modulares Schwert	Lager	
D	2.00	40	50	12	Modular	R	GYHR2020K00-M25R	●	GYM25RD-D12-040	●	3
					Modular	L	GYHL2020K00-M25L	●	GYM25LD-D12-040	●	3
					Modular	R	GYHR2525M00-M25R	●	GYM25RD-D12-040	●	1
					Modular	L	GYHL2525M00-M25L	●	GYM25LD-D12-040	●	1
		Modular	R	GYHR3225P00-M25R	●	GYM25RD-D12-040	●	2			
		Modular	L	GYHL3225P00-M25L	●	GYM25LD-D12-040	●	2			
		Modular	R	GYHR3232P00-M25R	●	GYM25RD-D12-040	●	2			
		Modular	L	GYHL3232P00-M25L	●	GYM25LD-D12-040	●	2			
		50	60	12	Modular	R	GYHR2020K00-M25R	●	GYM25RD-D12-050	●	3
					Modular	L	GYHL2020K00-M25L	●	GYM25LD-D12-050	●	3
					Modular	R	GYHR2525M00-M25R	●	GYM25RD-D12-050	●	1
					Modular	L	GYHL2525M00-M25L	●	GYM25LD-D12-050	●	1
	60	75	12	Modular	R	GYHR3225P00-M25R	●	GYM25RD-D12-050	●	2	
				Modular	L	GYHL3225P00-M25L	●	GYM25LD-D12-050	●	2	
				Modular	R	GYHR3232P00-M25R	●	GYM25RD-D12-050	●	2	
				Modular	L	GYHL3232P00-M25L	●	GYM25LD-D12-050	●	2	
	2.24	60	75	12	Modular	R	GYHR2020K00-M25R	●	GYM25RD-D12-060	●	3
					Modular	L	GYHL2020K00-M25L	●	GYM25LD-D12-060	●	3
					Modular	R	GYHR2525M00-M25R	●	GYM25RD-D12-060	●	1
					Modular	L	GYHL2525M00-M25L	●	GYM25LD-D12-060	●	1
75		100	12	Modular	R	GYHR3225P00-M25R	●	GYM25RD-D12-060	●	2	
				Modular	L	GYHL3225P00-M25L	●	GYM25LD-D12-060	●	2	
				Modular	R	GYHR3232P00-M25R	●	GYM25RD-D12-060	●	2	
				Modular	L	GYHL3232P00-M25L	●	GYM25LD-D12-060	●	2	
75	100	12	Modular	R	GYHR2020K00-M25R	●	GYM25RD-D12-075	●	3		
			Modular	L	GYHL2020K00-M25L	●	GYM25LD-D12-075	●	3		
			Modular	R	GYHR2525M00-M25R	●	GYM25RD-D12-075	●	1		
			Modular	L	GYHL2525M00-M25L	●	GYM25LD-D12-075	●	1		
Modular	R	GYHR3225P00-M25R	●	GYM25RD-D12-075	●	2					
Modular	L	GYHL3225P00-M25L	●	GYM25LD-D12-075	●	2					
Modular	R	GYHR3232P00-M25R	●	GYM25RD-D12-075	●	2					
Modular	L	GYHL3232P00-M25L	●	GYM25LD-D12-075	●	2					

\*1 Die dargestellten Abmessungen gelten bei der Verwendung von Standard-WSP. Wenn andere WSP-Geometrien verwendet werden, können die Werte für LF, LH, LH2, und WF variieren.

● : Lagerstandard.

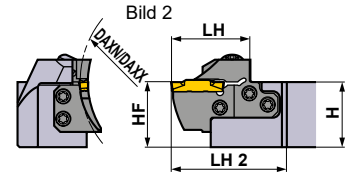
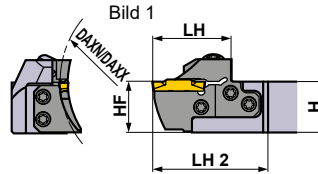
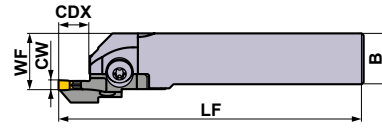
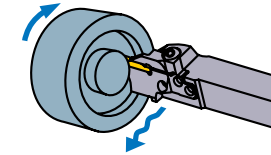

Abb. zeigt Rechtsausführung.

\* Schlüssel : ① : Spannschraube, ② : Schraube für Schwert

ERSATZTEILE			
Halter			
	Spannschraube	Schraube für Schwert 5 St.	Schlüssel*
GYHR/L2020K00-M25R/L	GY06013M (Spannmoment : 6.0N·m)	TS55 (Spannmoment : 5.0N·m)	①TKY30R ②TKY25D
GYHR/L2525M00-M25R/L			
GYHR/L3225P00-M25R/L			
GYHR/L3232P00-M25R/L			

	Abmessungen (mm) *1								Schnittmodus
	H	B	LF	LH	LH 2	HF	WF	HBH	
	20	20	125	39	60	20	26	5	R
	20	20	125	39	60	20	26	5	
	25	25	150	39	57	25	28	—	R
	25	25	150	39	57	25	28	—	
	32	25	170	39	57	32	28	—	R
	32	25	170	39	57	32	28	—	
	32	32	170	39	57	32	35	—	R
	32	32	170	39	57	32	35	—	
	20	20	125	39	60	20	26	5	L
	20	20	125	39	60	20	26	5	
	25	25	150	39	57	25	28	—	L
	25	25	150	39	57	25	28	—	
	32	25	170	39	57	32	28	—	L
	32	25	170	39	57	32	28	—	
	32	32	170	39	57	32	35	—	L
	32	32	170	39	57	32	35	—	
	20	20	125	39	60	20	26	5	L
	20	20	125	39	60	20	26	5	
	25	25	150	39	57	25	28	—	L
	25	25	150	39	57	25	28	—	
	32	25	170	39	57	32	28	—	L
	32	25	170	39	57	32	28	—	
	32	32	170	39	57	32	35	—	L
	32	32	170	39	57	32	35	—	

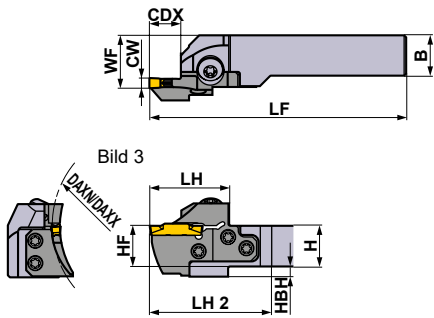
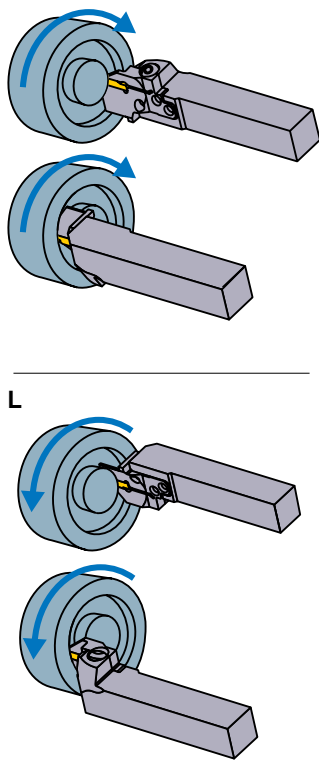

WSP-Auswahl

Sitzgröße	Spannbrecher Bezeichnung	
D	GY○○0200/0224D○○○○—Spannbrecher nachstehend abgebildet	

Spannbrecher zum Einstechen/Abstechen > F012, F013					
Sitzgröße	Spannbrecher	GU	GS	GM	GFGS
		(Für langspannte Stähle)	(Kleine Vorschübe)	(Mittlere Vorschübe)	(Cehärteter Stahl)
D	2.00mm	●	●	●	●

Multifunktionsspannbrecher > F014, F015					
Sitzgröße	Spannbrecher	MF	MS	MM	BM
		(Schichten)	(Kleine Vorschübe)	(Mittlere Vorschübe)	(Kopierdrehen)
D	2.00mm	●	●	●	●
	2.24mm	●	●	●	●

● : Standard-WSP mit Abmessungen

## GY SERIE (AXIALEINSTECHEN)

### 4

### 00° Ausführung

WSP	GY2M <sup>GS</sup> <sub>GM</sub>	WSP	GY2G <sup>GS</sup> <sub>MF</sub>
WSP	GY2M <sup>GU</sup>	WSP	GY2M <sup>MS</sup>
WSP	GY1 <sup>GM</sup> <sub>GFGS</sub>	WSP	GY2M <sup>MM</sup>

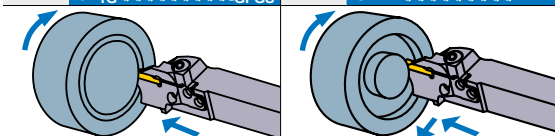

WSP GY2M<sup>BM</sup>

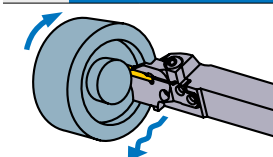

Hinweis 1) Modulare Schwerter und modulare Halter bitte separat bestellen.  
Hinweis 2) Bitte Modul in Rechtsausführung für den Halter in Rechtsausführung und Modul in Linksausführung für den Halter in Linksausführung verwenden.



Abb. zeigt Rechtsausführung.

Sitzgröße	Abmessungen (mm)				Typ	Ausführung (R/L)	Bestellbezeichnung				Bild
	CW	DAXN	DAXX	CDX			Halter	Lager	Modulares Schwert	Lager	
D	2.00 2.24	100	150	12	Modular	R	GYHR2020K00-M25R	●	GYM25RD-D12-100	●	3
					Modular	L	GYHL2020K00-M25L	●	GYM25LD-D12-100	●	3
					Modular	R	GYHR2525M00-M25R	●	GYM25RD-D12-100	●	1
					Modular	L	GYHL2525M00-M25L	●	GYM25LD-D12-100	●	1
		Modular	R	GYHR3225P00-M25R	●	GYM25RD-D12-100	●	2			
		Modular	L	GYHL3225P00-M25L	●	GYM25LD-D12-100	●	2			
		Modular	R	GYHR3232P00-M25R	●	GYM25RD-D12-100	●	2			
		Modular	L	GYHL3232P00-M25L	●	GYM25LD-D12-100	●	2			
	135	200	12	Modular	R	GYHR2020K00-M25R	●	GYM25RD-D12-135	●	3	
				Modular	L	GYHL2020K00-M25L	●	GYM25LD-D12-135	●	3	
				Modular	R	GYHR2525M00-M25R	●	GYM25RD-D12-135	●	1	
				Modular	L	GYHL2525M00-M25L	●	GYM25LD-D12-135	●	1	
180	250	12	Modular	R	GYHR3225P00-M25R	●	GYM25RD-D12-135	●	2		
			Modular	L	GYHL3225P00-M25L	●	GYM25LD-D12-135	●	2		
			Modular	R	GYHR3232P00-M25R	●	GYM25RD-D12-135	●	2		
			Modular	L	GYHL3232P00-M25L	●	GYM25LD-D12-135	●	2		
180	250	12	Modular	R	GYHR2020K00-M25R	●	GYM25RD-D12-180	●	3		
			Modular	L	GYHL2020K00-M25L	●	GYM25LD-D12-180	●	3		
			Modular	R	GYHR2525M00-M25R	●	GYM25RD-D12-180	●	1		
			Modular	L	GYHL2525M00-M25L	●	GYM25LD-D12-180	●	1		
180	250	12	Modular	R	GYHR3225P00-M25R	●	GYM25RD-D12-180	●	2		
			Modular	L	GYHL3225P00-M25L	●	GYM25LD-D12-180	●	2		
180	250	12	Modular	R	GYHR3232P00-M25R	●	GYM25RD-D12-180	●	2		
			Modular	L	GYHL3232P00-M25L	●	GYM25LD-D12-180	●	2		

\*1 Die dargestellten Abmessungen gelten bei der Verwendung von Standard-WSP. Wenn andere WSP-Geometrien verwendet werden, können die Werte für LF, LH, LH2, und WF variieren.

● : Lagerstandard.

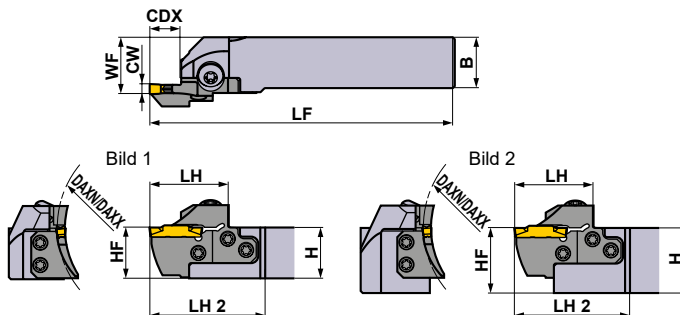



Abb. zeigt Rechtsausführung.

\* Schlüssel : ① : Spannschraube, ② : Schraube für Schwert

ERSATZTEILE			
Halter			
	Spannschraube	Schraube für Schwert 5 St.	Schlüssel*
GYHR/L2020K00-M25R/L	GY06013M (Spannmoment : 6.0N·m)	TS55 (Spannmoment : 5.0N·m)	①TKY30R ②TKY25D
GYHR/L2525M00-M25R/L			
GYHR/L3225P00-M25R/L			
GYHR/L3232P00-M25R/L			

	Abmessungen (mm) *1								Schnittmodus
	H	B	LF	LH	LH 2	HF	WF	HBH	
	20	20	125	39	60	20	26	5	R
	20	20	125	39	60	20	26	5	
	25	25	150	39	57	25	28	—	R
	25	25	150	39	57	25	28	—	
	32	25	170	39	57	32	28	—	R
	32	25	170	39	57	32	28	—	
	32	32	170	39	57	32	35	—	R
	32	32	170	39	57	32	35	—	
	20	20	125	39	60	20	26	5	L
	20	20	125	39	60	20	26	5	
	25	25	150	39	57	25	28	—	L
	25	25	150	39	57	25	28	—	
	32	25	170	39	57	32	28	—	L
	32	25	170	39	57	32	28	—	
	32	32	170	39	57	32	35	—	L
	32	32	170	39	57	32	35	—	
	20	20	125	39	60	20	26	5	L
	20	20	125	39	60	20	26	5	
	25	25	150	39	57	25	28	—	L
	25	25	150	39	57	25	28	—	
	32	25	170	39	57	32	28	—	L
	32	25	170	39	57	32	28	—	
	32	32	170	39	57	32	35	—	L
	32	32	170	39	57	32	35	—	

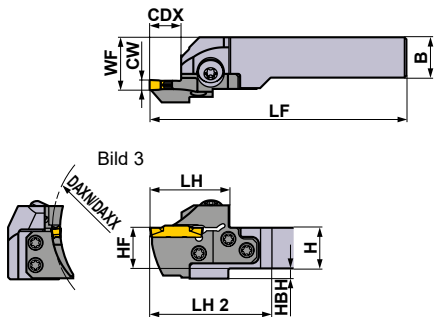
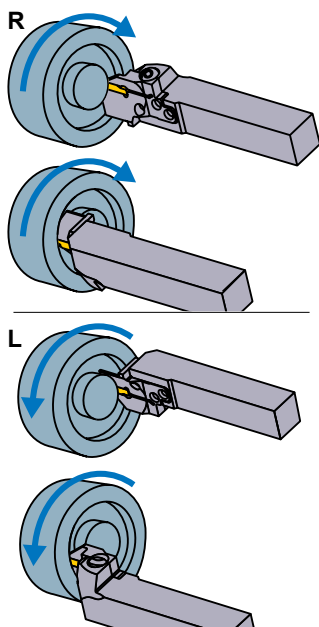

WSP-Auswahl

Sitzgröße	Spannbrecher Bezeichnung	
D	GY000200/0224D0000—Spannbrecher nachstehend abgebildet	

Spannbrecher zum Einstechen/Abstechen > F012, F013					
Sitzgröße	Spannbrecher	GU	GS	GM	GFGS
		(Für langspannte Stähle)	(Kleine Vorschübe)	(Mittlere Vorschübe)	(Cehärteter Stahl)
D	2.00mm	●	●	●	●

Multifunktionsspannbrecher > F014, F015					
Sitzgröße	Spannbrecher	MF	MS	MM	BM
		(Schlichten)	(Kleine Vorschübe)	(Mittlere Vorschübe)	(Kopierdrehen)
					Kugelform
D	2.00mm	●	●	●	●
	2.24mm	●	●	●	●

● : Standard-WSP mit Abmessungen

## GY SERIE (AXIALEINSTECHEN)

### 4

### 00° Ausführung

Hinweis 1) Modulare Schwerter und modulare Halter bitte separat bestellen.  
Hinweis 2) Spitze Modul in Rechtsausführung für den Halter in Rechtsausführung und Modul in Linksausführung für den Halter in Linksausführung verwenden.

WSP	GY2M <sup>GS</sup>	WSP	GY2G <sup>MF</sup>
WSP	GY2M <sup>GU</sup>	WSP	GY2M <sup>MS</sup>
WSP	GY1 <sup>GM</sup> <sub>GFGS</sub>	WSP	GY2M <sup>MM</sup>

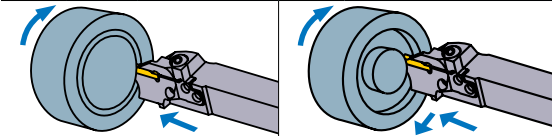

WSP GY2M<sup>BM</sup>



Abb. zeigt Rechtsausführung.

Sitzgröße	Abmessungen (mm)				Typ	Ausführung (R/L)	Bestellbezeichnung				Bild
	CW	DAXN	DAXX	CDX			Halter	Lager	Modulares Schwert	Lager	
E	2.39 2.50 2.74	40	50	12	Modular	R	GYHR2020K00-M25R	●	GYM25RD-E12-040	●	3
					Modular	L	GYHL2020K00-M25L	●	GYM25LD-E12-040	●	3
					Modular	R	GYHR2525M00-M25R	●	GYM25RD-E12-040	●	1
					Modular	L	GYHL2525M00-M25L	●	GYM25LD-E12-040	●	1
		Modular	R	GYHR3225P00-M25R	●	GYM25RD-E12-040	●	2			
		Modular	L	GYHL3225P00-M25L	●	GYM25LD-E12-040	●	2			
		Modular	R	GYHR3232P00-M25R	●	GYM25RD-E12-040	●	2			
		Modular	L	GYHL3232P00-M25L	●	GYM25LD-E12-040	●	2			
	50	60	12	Modular	R	GYHR2020K00-M25R	●	GYM25RD-E12-050	●	3	
				Modular	L	GYHL2020K00-M25L	●	GYM25LD-E12-050	●	3	
				Modular	R	GYHR2525M00-M25R	●	GYM25RD-E12-050	●	1	
				Modular	L	GYHL2525M00-M25L	●	GYM25LD-E12-050	●	1	
	60	75	12	Modular	R	GYHR3225P00-M25R	●	GYM25RD-E12-050	●	2	
				Modular	L	GYHL3225P00-M25L	●	GYM25LD-E12-050	●	2	
				Modular	R	GYHR3232P00-M25R	●	GYM25RD-E12-050	●	2	
				Modular	L	GYHL3232P00-M25L	●	GYM25LD-E12-050	●	2	
	75	100	12	Modular	R	GYHR2020K00-M25R	●	GYM25RD-E12-060	●	3	
				Modular	L	GYHL2020K00-M25L	●	GYM25LD-E12-060	●	3	
				Modular	R	GYHR2525M00-M25R	●	GYM25RD-E12-060	●	1	
				Modular	L	GYHL2525M00-M25L	●	GYM25LD-E12-060	●	1	
Modular		R	GYHR3225P00-M25R	●	GYM25RD-E12-060	●	2				
Modular		L	GYHL3225P00-M25L	●	GYM25LD-E12-060	●	2				
Modular		R	GYHR3232P00-M25R	●	GYM25RD-E12-060	●	2				
Modular		L	GYHL3232P00-M25L	●	GYM25LD-E12-060	●	2				
75	100	12	Modular	R	GYHR2020K00-M25R	●	GYM25RD-E12-075	●	3		
			Modular	L	GYHL2020K00-M25L	●	GYM25LD-E12-075	●	3		
			Modular	R	GYHR2525M00-M25R	●	GYM25RD-E12-075	●	1		
			Modular	L	GYHL2525M00-M25L	●	GYM25LD-E12-075	●	1		
Modular	R	GYHR3225P00-M25R	●	GYM25RD-E12-075	●	2					
Modular	L	GYHL3225P00-M25L	●	GYM25LD-E12-075	●	2					
Modular	R	GYHR3232P00-M25R	●	GYM25RD-E12-075	●	2					
Modular	L	GYHL3232P00-M25L	●	GYM25LD-E12-075	●	2					

\*1 Die dargestellten Abmessungen gelten bei der Verwendung von Standard-WSP. Wenn andere WSP-Geometrien verwendet werden, können die Werte für LF, LH, LH2, und WF variieren.

● : Lagerstandard.

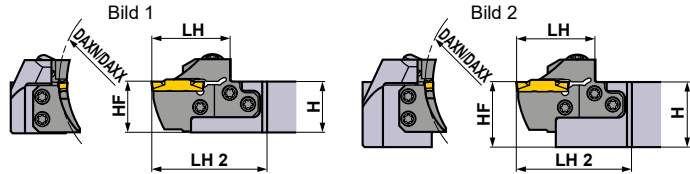
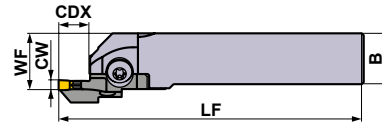
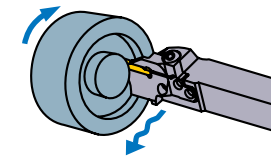

Abb. zeigt Rechtsausführung.

\* Schlüssel : ① : Spannschraube, ② : Schraube für Schwert

ERSATZTEILE			
Halter	Spannschraube	Schraube für Schwert 5 St.	Schlüssel*
GYHR/L2020K00-M25R/L	GY06013M (Spannmoment : 6.0N·m)	TS55 (Spannmoment : 5.0N·m)	①TKY30R ②TKY25D
GYHR/L2525M00-M25R/L			
GYHR/L3225P00-M25R/L			
GYHR/L3232P00-M25R/L			

	Abmessungen (mm) *1								Schnittmodus	
	H	B	LF	LH	LH 2	HF	WF	HBH		
	20	20	125	39	60	20	26	5	R	
	20	20	125	39	60	20	26	5		
	25	25	150	39	57	25	28	—		
	25	25	150	39	57	25	28	—		
	32	25	170	39	57	32	28	—		
	32	25	170	39	57	32	28	—		
	32	32	170	39	57	32	35	—		
	32	32	170	39	57	32	35	—		
	20	20	125	39	60	20	26	5		
	20	20	125	39	60	20	26	5		
	25	25	150	39	57	25	28	—		
	25	25	150	39	57	25	28	—		
	32	25	170	39	57	32	28	—		
	32	25	170	39	57	32	28	—		
	32	32	170	39	57	32	35	—		
	32	32	170	39	57	32	35	—		
	20	20	125	39	60	20	26	5		L
	20	20	125	39	60	20	26	5		
	25	25	150	39	57	25	28	—		
	25	25	150	39	57	25	28	—		
	32	25	170	39	57	32	28	—		
	32	25	170	39	57	32	28	—		
	32	32	170	39	57	32	35	—		
	32	32	170	39	57	32	35	—		
	20	20	125	39	60	20	26	5		
	20	20	125	39	60	20	26	5		
	25	25	150	39	57	25	28	—		
	25	25	150	39	57	25	28	—		
	32	25	170	39	57	32	28	—		
	32	25	170	39	57	32	28	—		
	32	32	170	39	57	32	35	—		
	32	32	170	39	57	32	35	—		

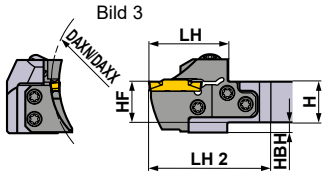
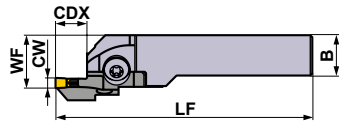
WSP-Auswahl

Sitzgröße	Spannbrecher Bezeichnung
E	GY <span style="border: 1px dashed black; border-radius: 50%; padding: 2px;">0239/0250/0274E</span> <small>Spannbrecher nachstehend abgebildet</small>

Spannbrecher zum Einstechen/Abstechen > F012, F013					
Sitzgröße	Spannbrecher	GU	GS	GM	GFGS
	<small>(Für langspannte Stähle)</small>	<small>(Kleine Vorschübe)</small>	<small>(Mittlere Vorschübe)</small>	<small>(Gehärteter Stahl)</small>	
E	2.39mm	●	●	●	●
	2.50mm	●	●	●	●

Multifunktionsspannbrecher > F014, F015					
Sitzgröße	Spannbrecher	MF	MS	MM	BM
	<small>(Schichten)</small>	<small>(Kleine Vorschübe)</small>	<small>(Mittlere Vorschübe)</small>	<small>(Kopierdrehen)</small>	
E	2.39mm	●			Kugelform
	2.50mm	●	●	●	
	2.74mm	●			

● : Standard-WSP mit Abmessungen

EINSTECHEN / ABSTECHEN

## GY SERIE (AXIALEINSTECHEN)

### 4

### 00° Ausführung

Hinweis 1) Modulare Schwerter und modulare Halter bitte separat bestellen.  
Hinweis 2) Bitte Modul in Rechtsausführung für den Halter in Rechtsausführung und Modul in Linksausführung für den Halter in Linksausführung verwenden.

WSP	GY2M <sup>GS</sup> <sub>GM</sub>	WSP	GY2G <sup>GS</sup> <sub>GM</sub> -MF
WSP	GY2M <sup>GS</sup> <sub>GM</sub> -GU	WSP	GY2M <sup>GS</sup> <sub>GM</sub> -MS
WSP	GY1 <sup>GM</sup> <sub>GFGS</sub>	WSP	GY2M <sup>GM</sup> <sub>GFGS</sub> -MM



Abb. zeigt Rechtsausführung.

Sitzgröße	Abmessungen (mm)				Typ	Ausführung (R/L)	Bestellbezeichnung				Bild
	CW	DAXN	DAXX	CDX			Halter	Lager	Modulares Schwert	Lager	
E	2.39 2.50 2.74	100	150	12	Modular	R	GYHR2020K00-M25R	●	GYM25RD-E12-100	●	3
					Modular	L	GYHL2020K00-M25L	●	GYM25LD-E12-100	●	3
					Modular	R	GYHR2525M00-M25R	●	GYM25RD-E12-100	●	1
					Modular	L	GYHL2525M00-M25L	●	GYM25LD-E12-100	●	1
		Modular	R	GYHR3225P00-M25R	●	GYM25RD-E12-100	●	2			
		Modular	L	GYHL3225P00-M25L	●	GYM25LD-E12-100	●	2			
		Modular	R	GYHR3232P00-M25R	●	GYM25RD-E12-100	●	2			
		Modular	L	GYHL3232P00-M25L	●	GYM25LD-E12-100	●	2			
	135	200	12	Modular	R	GYHR2020K00-M25R	●	GYM25RD-E12-135	●	3	
				Modular	L	GYHL2020K00-M25L	●	GYM25LD-E12-135	●	3	
				Modular	R	GYHR2525M00-M25R	●	GYM25RD-E12-135	●	1	
				Modular	L	GYHL2525M00-M25L	●	GYM25LD-E12-135	●	1	
	180	250	12	Modular	R	GYHR3225P00-M25R	●	GYM25RD-E12-135	●	2	
				Modular	L	GYHL3225P00-M25L	●	GYM25LD-E12-135	●	2	
				Modular	R	GYHR3232P00-M25R	●	GYM25RD-E12-135	●	2	
				Modular	L	GYHL3232P00-M25L	●	GYM25LD-E12-135	●	2	
180	250	12	Modular	R	GYHR2020K00-M25R	●	GYM25RD-E12-180	●	3		
			Modular	L	GYHL2020K00-M25L	●	GYM25LD-E12-180	●	3		
			Modular	R	GYHR2525M00-M25R	●	GYM25RD-E12-180	●	1		
			Modular	L	GYHL2525M00-M25L	●	GYM25LD-E12-180	●	1		
180	250	12	Modular	R	GYHR3225P00-M25R	●	GYM25RD-E12-180	●	2		
			Modular	L	GYHL3225P00-M25L	●	GYM25LD-E12-180	●	2		
180	250	12	Modular	R	GYHR3232P00-M25R	●	GYM25RD-E12-180	●	2		
			Modular	L	GYHL3232P00-M25L	●	GYM25LD-E12-180	●	2		

\*1 Die dargestellten Abmessungen gelten bei der Verwendung von Standard-WSP. Wenn andere WSP-Geometrien verwendet werden, können die Werte für LF, LH, LH2, und WF variieren.

● : Lagerstandard.

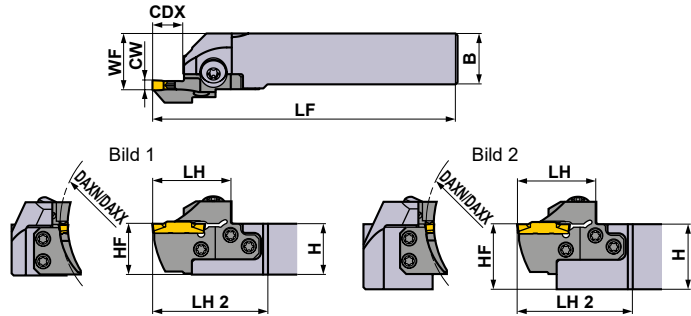
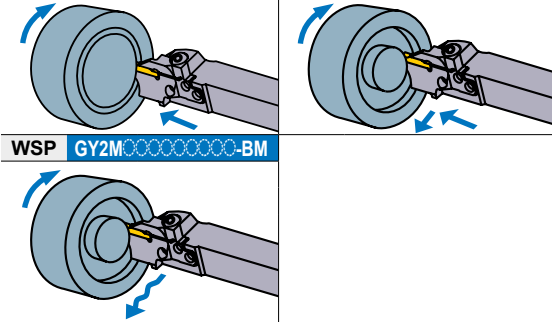

Abb. zeigt Rechtsausführung.

\* Schlüssel : ① : Spannschraube, ② : Schraube für Schwert

ERSATZTEILE			
Halter			
	Spannschraube	Schraube für Schwert 5 St.	Schlüssel*
GYHR/L2020K00-M25R/L	GY06013M (Spannmoment : 6.0N·m)	TS55 (Spannmoment : 5.0N·m)	①TKY30R ②TKY25D
GYHR/L2525M00-M25R/L			
GYHR/L3225P00-M25R/L			
GYHR/L3232P00-M25R/L			

	Abmessungen (mm) *1								Schnittmodus
	H	B	LF	LH	LH 2	HF	WF	HBH	
	20	20	125	39	60	20	26	5	R
	20	20	125	39	60	20	26	5	
	25	25	150	39	57	25	28	—	R
	25	25	150	39	57	25	28	—	
	32	25	170	39	57	32	28	—	R
	32	25	170	39	57	32	28	—	
	32	32	170	39	57	32	35	—	R
	32	32	170	39	57	32	35	—	
	20	20	125	39	60	20	26	5	L
	20	20	125	39	60	20	26	5	
	25	25	150	39	57	25	28	—	L
	25	25	150	39	57	25	28	—	
	32	25	170	39	57	32	28	—	L
	32	25	170	39	57	32	28	—	
	32	32	170	39	57	32	35	—	L
	32	32	170	39	57	32	35	—	
	20	20	125	39	60	20	26	5	L
	20	20	125	39	60	20	26	5	
	25	25	150	39	57	25	28	—	L
	25	25	150	39	57	25	28	—	
	32	25	170	39	57	32	28	—	L
	32	25	170	39	57	32	28	—	
	32	32	170	39	57	32	35	—	L
	32	32	170	39	57	32	35	—	

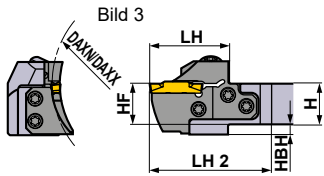
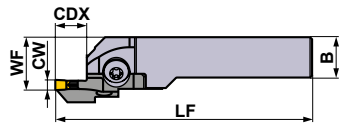
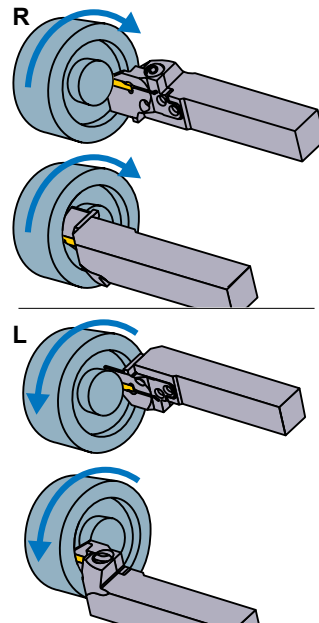

WSP-Auswahl

Sitzgröße	Spannbrecher Bezeichnung	
E	GY	0239/0250/0274E

Spannbrecher zum Einstechen/Abstechen > F012, F013					
Sitzgröße	Spannbrecher CW	GU	GS	GM	GFGS
		(Für langspannte Stähle)	(Kleine Vorschübe)	(Mittlere Vorschübe)	(Cehärteter Stahl)
E	2.39mm	●	●	●	●
	2.50mm	●	●	●	●

Multifunktionspannbrecher > F014, F015					
Sitzgröße	Spannbrecher CW	MF	MS	MM	BM
		(Schichten)	(Kleine Vorschübe)	(Mittlere Vorschübe)	(Kopierdrehen)
E	2.39mm	●			Kugelform
	2.50mm	●	●	●	
	2.74mm	●			

● : Standard-WSP mit Abmessungen

EINSTECHEN / ABSTECHE

## GY SERIE (AXIALEINSTECHEN)

### 4

### 00° Ausführung

Hinweis 1) Modulare Schwerter und modulare Halter bitte separat bestellen.  
Hinweis 2) Bitte Modul in Rechtsausführung für den Halter in Rechtsausführung und Modul in Linksausführung für den Halter in Linksausführung verwenden.

WSP	GY2M <sup>GS</sup> <sub>GM</sub>	WSP	GY2G <sup>GS</sup> <sub>MF</sub>
WSP	GY2M <sup>GU</sup>	WSP	GY2M <sup>MS</sup>
WSP	GY2M <sup>GM</sup> <sub>GFGS</sub>	WSP	GY2M <sup>MM</sup>

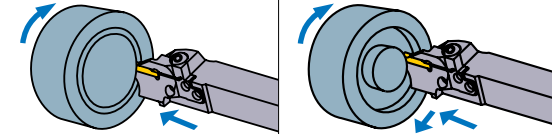

WSP GY2M<sup>BM</sup>



Abb. zeigt Rechtsausführung.

Sitzgröße	Abmessungen (mm)				Typ	Ausführung (R/L)	Bestellbezeichnung				Bild
	CW	DAXN	DAXX	CDX			Halter	Lager	Modulares Schwert	Lager	
F	3.00 3.18 3.24	35	40	12	Modular	R	GYHR2020K00-M25R	●	GYM25RD-F12-035	●	3
					Modular	L	GYHL2020K00-M25L	●	GYM25LD-F12-035	●	3
					Modular	R	GYHR2525M00-M25R	●	GYM25RD-F12-035	●	1
					Modular	L	GYHL2525M00-M25L	●	GYM25LD-F12-035	●	1
		Modular	R	GYHR3225P00-M25R	●	GYM25RD-F12-035	●	2			
		Modular	L	GYHL3225P00-M25L	●	GYM25LD-F12-035	●	2			
		Modular	R	GYHR3232P00-M25R	●	GYM25RD-F12-035	●	2			
		Modular	L	GYHL3232P00-M25L	●	GYM25LD-F12-035	●	2			
	50	40	50	12	Modular	R	GYHR2020K00-M25R	●	GYM25RD-F12-040	●	3
					Modular	L	GYHL2020K00-M25L	●	GYM25LD-F12-040	●	3
					Modular	R	GYHR2525M00-M25R	●	GYM25RD-F12-040	●	1
					Modular	L	GYHL2525M00-M25L	●	GYM25LD-F12-040	●	1
		Modular	R	GYHR3225P00-M25R	●	GYM25RD-F12-040	●	2			
		Modular	L	GYHL3225P00-M25L	●	GYM25LD-F12-040	●	2			
		Modular	R	GYHR3232P00-M25R	●	GYM25RD-F12-040	●	2			
		Modular	L	GYHL3232P00-M25L	●	GYM25LD-F12-040	●	2			
60	50	60	12	Modular	R	GYHR2020K00-M25R	●	GYM25RD-F12-050	●	3	
				Modular	L	GYHL2020K00-M25L	●	GYM25LD-F12-050	●	3	
				Modular	R	GYHR2525M00-M25R	●	GYM25RD-F12-050	●	1	
				Modular	L	GYHL2525M00-M25L	●	GYM25LD-F12-050	●	1	
Modular	R	GYHR3225P00-M25R	●	GYM25RD-F12-050	●	2					
Modular	L	GYHL3225P00-M25L	●	GYM25LD-F12-050	●	2					
Modular	R	GYHR3232P00-M25R	●	GYM25RD-F12-050	●	2					
Modular	L	GYHL3232P00-M25L	●	GYM25LD-F12-050	●	2					

\*1 Die dargestellten Abmessungen gelten bei der Verwendung von Standard-WSP. Wenn andere WSP-Geometrien verwendet werden, können die Werte für LF, LH, LH2, und WF variieren.

● : Lagerstandard.

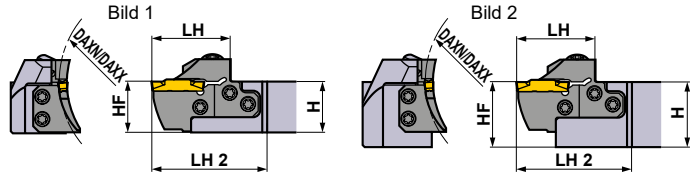
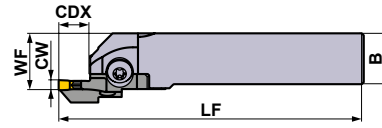
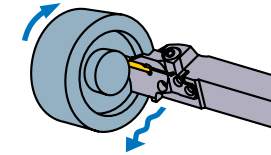

Abb. zeigt Rechtsausführung.

\* Schlüssel : ① : Spannschraube, ② : Schraube für Schwert

ERSATZTEILE			
Halter			
	Spannschraube	Schraube für Schwert 5 St.	Schlüssel*
GYHR/L2020K00-M25R/L	GY06013M (Spannmoment : 6.0N·m)	TS55 (Spannmoment : 5.0N·m)	①TKY30R ②TKY25D
GYHR/L2525M00-M25R/L			
GYHR/L3225P00-M25R/L			
GYHR/L3232P00-M25R/L			

	Abmessungen (mm) *1							
	H	B	LF	LH	LH 2	HF	WF	HBH
	20	20	125	39	60	20	26	5
	20	20	125	39	60	20	26	5
	25	25	150	39	57	25	28	—
	25	25	150	39	57	25	28	—
	32	25	170	39	57	32	28	—
	32	25	170	39	57	32	28	—
	32	32	170	39	57	32	35	—
	32	32	170	39	57	32	35	—
	20	20	125	39	60	20	26	5
	20	20	125	39	60	20	26	5
	25	25	150	39	57	25	28	—
	25	25	150	39	57	25	28	—
	32	25	170	39	57	32	28	—
	32	25	170	39	57	32	28	—
	32	32	170	39	57	32	35	—
	32	32	170	39	57	32	35	—
	20	20	125	39	60	20	26	5
	20	20	125	39	60	20	26	5
	25	25	150	39	57	25	28	—
	25	25	150	39	57	25	28	—
	32	25	170	39	57	32	28	—
	32	25	170	39	57	32	28	—
	32	32	170	39	57	32	35	—
	32	32	170	39	57	32	35	—

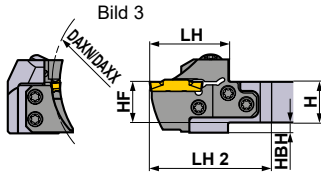
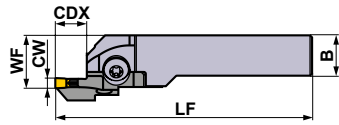
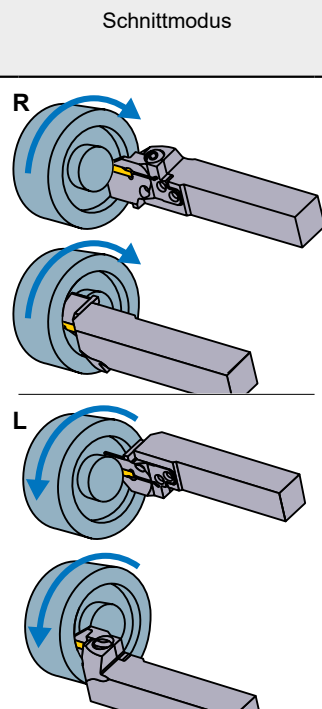

WSP-Auswahl

Sitzgröße	Spannbrecher Bezeichnung
F	GY <span style="border: 1px solid black; border-radius: 50%; padding: 2px;">0300/0318/0324</span> F <span style="border: 1px solid black; border-radius: 50%; padding: 2px;">0000</span> — Spannbrecher nachstehend abgebildet

Spannbrecher zum Einstechen/Abstechen > F012, F013					
Sitzgröße	Spannbrecher CW	GU	GS	GM	GFGS
		(Für langspannte Stähle)	(Kleine Vorschübe)	(Mittlere Vorschübe)	(Cehärteter Stahl)
F	3.00mm	●	●	●	●
	3.18mm	●	●	●	●

Multifunktionsspannbrecher > F014, F015					
Sitzgröße	Spannbrecher CW	MF	MS	MM	BM
		(Schichten)	(Kleine Vorschübe)	(Mittlere Vorschübe)	(Kopierdrehen)
F	3.00mm				●
	RE 0.2	●	●	●	
	RE 0.4	●	●	●	
	RE 0.8			●	
	3.18mm				●
	RE 0.2	●			
	RE 0.4	●			
	3.24mm	●			

● : Standard-WSP mit Abmessungen

EINSTECHEN / ABSTECHE



# GY SERIE (AXIALEINSTECHEN)

4

00° Ausführung

Hinweis 1) Modulare Schwerter und modulare Halter bitte separat bestellen.  
Hinweis 2) Spitze Modul in Rechtsausführung für den Halter in Rechtsausführung und Modul in Linksausführung für den Halter in Linksausführung verwenden.

WSP	GY2M <sup>GS</sup>	WSP	GY2G <sup>MF</sup>
WSP	GY2M <sup>GU</sup>	WSP	GY2M <sup>MS</sup>
WSP	GY1 <sup>GM</sup> <sub>GFGS</sub>	WSP	GY2M <sup>MM</sup>



Abb. zeigt Rechtsausführung.

Sitzgröße	Abmessungen (mm)				Typ	Ausführung (R/L)	Bestellbezeichnung				Bild
	CW	DAXN	DAXX	CDX			Halter	Lager	Modulares Schwert	Lager	
F	3.00 3.18 3.24	60	75	12	Modular	R	GYHR2020K00-M25R	●	GYM25RD-F12-060	●	3
					Modular	L	GYHL2020K00-M25L	●	GYM25LD-F12-060	●	3
					Modular	R	GYHR2525M00-M25R	●	GYM25RD-F12-060	●	1
					Modular	L	GYHL2525M00-M25L	●	GYM25LD-F12-060	●	1
					Modular	R	GYHR3225P00-M25R	●	GYM25RD-F12-060	●	5
					Modular	L	GYHL3225P00-M25L	●	GYM25LD-F12-060	●	5
		20 *2	Modular	R	GYHR2020K00-M25R	●	GYM25RD-F20-060	●	4		
			Modular	L	GYHL2020K00-M25L	●	GYM25LD-F20-060	●	4		
			Modular	R	GYHR2525M00-M25R	●	GYM25RD-F20-060	●	2		
			Modular	L	GYHL2525M00-M25L	●	GYM25LD-F20-060	●	2		
			Modular	R	GYHR3225P00-M25R	●	GYM25RD-F20-060	●	6		
			Modular	L	GYHL3225P00-M25L	●	GYM25LD-F20-060	●	6		
	75	100	12	Modular	R	GYHR2020K00-M25R	●	GYM25RD-F12-075	●	3	
				Modular	L	GYHL2020K00-M25L	●	GYM25LD-F12-075	●	3	
				Modular	R	GYHR2525M00-M25R	●	GYM25RD-F12-075	●	1	
				Modular	L	GYHL2525M00-M25L	●	GYM25LD-F12-075	●	1	
				Modular	R	GYHR3225P00-M25R	●	GYM25RD-F12-075	●	5	
				Modular	L	GYHL3225P00-M25L	●	GYM25LD-F12-075	●	5	
		20 *2	Modular	R	GYHR2020K00-M25R	●	GYM25RD-F20-075	●	4		
			Modular	L	GYHL2020K00-M25L	●	GYM25LD-F20-075	●	4		
			Modular	R	GYHR2525M00-M25R	●	GYM25RD-F20-075	●	2		
			Modular	L	GYHL2525M00-M25L	●	GYM25LD-F20-075	●	2		
			Modular	R	GYHR3225P00-M25R	●	GYM25RD-F20-075	●	6		
			Modular	L	GYHL3225P00-M25L	●	GYM25LD-F20-075	●	6		

\*1 Die dargestellten Abmessungen gelten bei der Verwendung von Standard-WSP. Wenn andere WSP-Geometrien verwendet werden, können die Werte für LF, LH, LH2, und WF variieren.

\*2 Die maximale Einstechtiefe (CDX) hängt von der verwendeten Schneidplatte ab. Zur maximalen Einstechtiefe (CDX) bei verschiedenen Schneidplatten siehe Seite F012–F015.

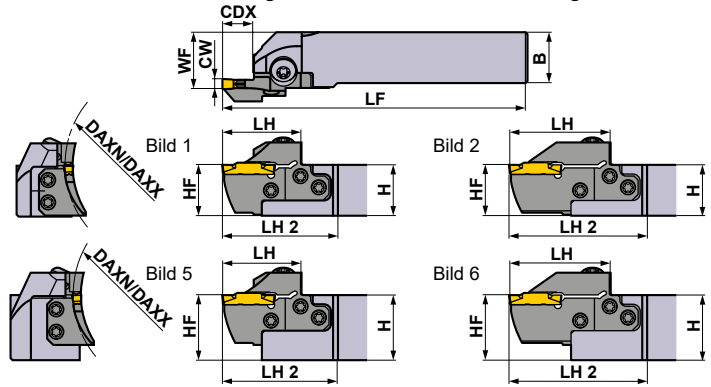
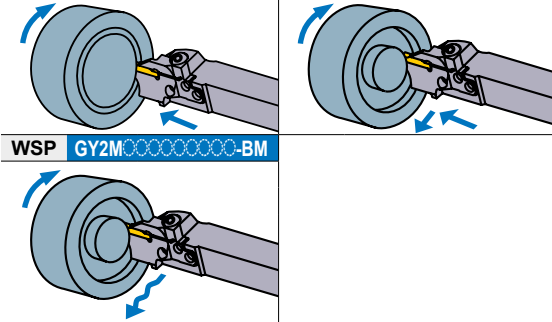
● : Lagerstandard.

EINSTECHEN / ABSTECHEN

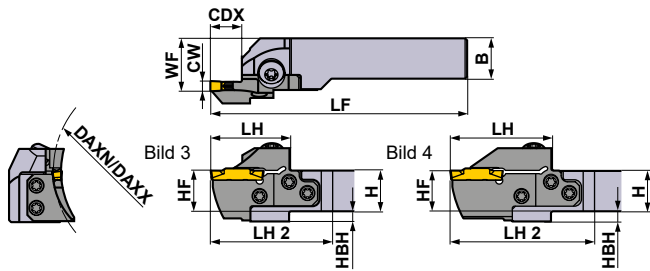

\* Schlüssel : ① : Spannschraube, ② : Schraube für Schwert

ERSATZTEILE			
Halter			
	Spannschraube	Schraube für Schwert 5 St.	Schlüssel*
GYHR/L2020K00-M25R/L	GY06013M (Spannmoment : 6.0N·m)	TS55 (Spannmoment : 5.0N·m)	①TKY30R ②TKY25D
GYHR/L2525M00-M25R/L			
GYHR/L3225P00-M25R/L			
GYHR/L3232P00-M25R/L			

Abb. zeigt Rechtsausführung.

	Abmessungen (mm) *1								Schnittmodus
	H	B	LF	LH	LH 2	HF	WF	HBH	
	20	20	125	39	60	20	26	5	R
	20	20	125	39	60	20	26	5	
	25	25	150	39	57	25	28	—	
	25	25	150	39	57	25	28	—	
	32	25	170	39	57	32	28	—	
	32	25	170	39	57	32	28	—	
	32	32	170	39	57	32	35	—	
	32	32	170	39	57	32	35	—	
	20	20	131	45	66	20	26	5	
	20	20	131	45	66	20	26	5	
	25	25	156	45	63	25	28	—	
	25	25	156	45	63	25	28	—	
	32	25	176	45	63	32	28	—	
	32	25	176	45	63	32	28	—	
	32	32	176	45	63	32	35	—	
	32	32	176	45	63	32	35	—	
	20	20	125	39	60	20	26	5	L
	20	20	125	39	60	20	26	5	
	25	25	150	39	57	25	28	—	
	25	25	150	39	57	25	28	—	
	32	25	170	39	57	32	28	—	
	32	25	170	39	57	32	28	—	
	32	32	170	39	57	32	35	—	
	32	32	170	39	57	32	35	—	
	20	20	131	45	66	20	26	5	
	20	20	131	45	66	20	26	5	
	25	25	156	45	63	25	28	—	
	25	25	156	45	63	25	28	—	
	32	25	176	45	63	32	28	—	
	32	25	176	45	63	32	28	—	
	32	32	176	45	63	32	35	—	
	32	32	176	45	63	32	35	—	

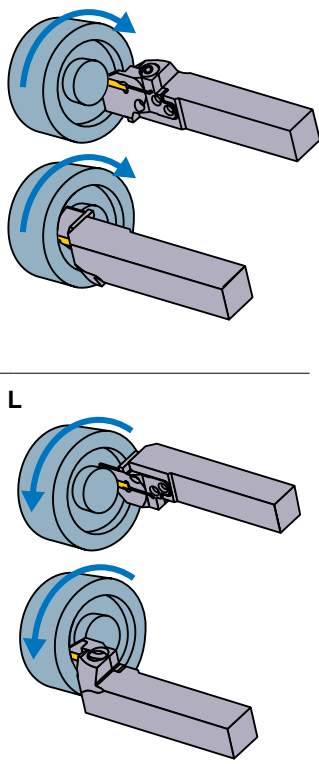

**WSP-Auswahl**

Sitzgröße	<b>Spannbrecher Bezeichnung</b>
F	GY <span style="border: 1px solid black; border-radius: 50%; padding: 2px;">0300/0318/0324F</span> <span style="border: 1px solid black; border-radius: 50%; padding: 2px;">0300</span> — Spannbrecher nachstehend abgebildet

Spannbrecher zum Einstechen/Abstechen > F012, F013					
Sitzgröße	Spannbrecher CW	GU	GS	GM	GFGS
		(Für langspannte Stähle)	(Kleine Vorschübe)	(Mittlere Vorschübe)	(Gehärteter Stahl)
F	3.00mm	●	●	●	●
	3.18mm	●	●	●	●

Multifunktionsspannbrecher > F014, F015					
Sitzgröße	Spannbrecher CW	MF	MS	MM	BM
		(Schichten)	(Kleine Vorschübe)	(Mittlere Vorschübe)	(Kopierdrehen)
F	3.00mm				●
	RE 0.2	●	●	●	
	RE 0.4	●	●	●	
	RE 0.8			●	
	3.18mm				●
	RE 0.2	●			
RE 0.4	●				
3.24mm	●				

● : Standard-WSP mit Abmessungen

IDENTIFIKATION > F008, F009  
 SCHNITTBEDINGUNGEN > F104  
 SICHERHEITSHINWEISE > F106

# GY SERIE (AXIALEINSTECHEN)

4

00° Ausführung

Hinweis 1) Modulare Schwerter und modulare Halter bitte separat bestellen.  
Hinweis 2) Spitze Modul in Rechtsausführung für den Halter in Rechtsausführung und Modul in Linksausführung für den Halter in Linksausführung verwenden.

WSP	GY2M <sup>GS</sup>	WSP	GY2G <sup>MF</sup>
WSP	GY2M <sup>GU</sup>	WSP	GY2M <sup>MS</sup>
WSP	GY1 <sup>GM</sup> <sub>GFGS</sub>	WSP	GY2M <sup>MM</sup>



Abb. zeigt Rechtsausführung.

Sitzgröße	Abmessungen (mm)				Typ	Ausführung (R/L)	Bestellbezeichnung				Bild
	CW	DAXN	DAXX	CDX			Halter	Lager	Modulares Schwert	Lager	
F	3.00 3.18 3.24	100	150	12	Modular	R	GYHR2020K00-M25R	●	GYM25RD-F12-100	●	3
					Modular	L	GYHL2020K00-M25L	●	GYM25LD-F12-100	●	3
					Modular	R	GYHR2525M00-M25R	●	GYM25RD-F12-100	●	1
					Modular	L	GYHL2525M00-M25L	●	GYM25LD-F12-100	●	1
					Modular	R	GYHR3225P00-M25R	●	GYM25RD-F12-100	●	5
					Modular	L	GYHL3225P00-M25L	●	GYM25LD-F12-100	●	5
					Modular	R	GYHR3232P00-M25R	●	GYM25RD-F12-100	●	5
					Modular	L	GYHL3232P00-M25L	●	GYM25LD-F12-100	●	5
	135	200	12	Modular	R	GYHR2020K00-M25R	●	GYM25RD-F20-100	●	4	
				Modular	L	GYHL2020K00-M25L	●	GYM25LD-F20-100	●	4	
				Modular	R	GYHR2525M00-M25R	●	GYM25RD-F20-100	●	2	
				Modular	L	GYHL2525M00-M25L	●	GYM25LD-F20-100	●	2	
			20 *2	Modular	R	GYHR3225P00-M25R	●	GYM25RD-F20-100	●	6	
				Modular	L	GYHL3225P00-M25L	●	GYM25LD-F20-100	●	6	
				Modular	R	GYHR3232P00-M25R	●	GYM25RD-F20-100	●	6	
				Modular	L	GYHL3232P00-M25L	●	GYM25LD-F20-100	●	6	
	135	200	12	Modular	R	GYHR2020K00-M25R	●	GYM25RD-F12-135	●	3	
				Modular	L	GYHL2020K00-M25L	●	GYM25LD-F12-135	●	3	
				Modular	R	GYHR2525M00-M25R	●	GYM25RD-F12-135	●	1	
				Modular	L	GYHL2525M00-M25L	●	GYM25LD-F12-135	●	1	
20 *2			Modular	R	GYHR3225P00-M25R	●	GYM25RD-F12-135	●	5		
			Modular	L	GYHL3225P00-M25L	●	GYM25LD-F12-135	●	5		
			Modular	R	GYHR3232P00-M25R	●	GYM25RD-F12-135	●	5		
			Modular	L	GYHL3232P00-M25L	●	GYM25LD-F12-135	●	5		
20 *2	Modular	R	GYHR2020K00-M25R	●	GYM25RD-F20-135	●	4				
	Modular	L	GYHL2020K00-M25L	●	GYM25LD-F20-135	●	4				
	Modular	R	GYHR2525M00-M25R	●	GYM25RD-F20-135	●	2				
	Modular	L	GYHL2525M00-M25L	●	GYM25LD-F20-135	●	2				
20 *2	Modular	R	GYHR3225P00-M25R	●	GYM25RD-F20-135	●	6				
	Modular	L	GYHL3225P00-M25L	●	GYM25LD-F20-135	●	6				
	Modular	R	GYHR3232P00-M25R	●	GYM25RD-F20-135	●	6				
	Modular	L	GYHL3232P00-M25L	●	GYM25LD-F20-135	●	6				

\*1 Die dargestellten Abmessungen gelten bei der Verwendung von Standard-WSP. Wenn andere WSP-Geometrien verwendet werden, können die Werte für LF, LH, LH2, und WF variieren.

\*2 Die maximale Einstechtiefe (CDX) hängt von der verwendeten Schneidplatte ab. Zur maximalen Einstechtiefe (CDX) bei verschiedenen Schneidplatten siehe Seite F012–F015.

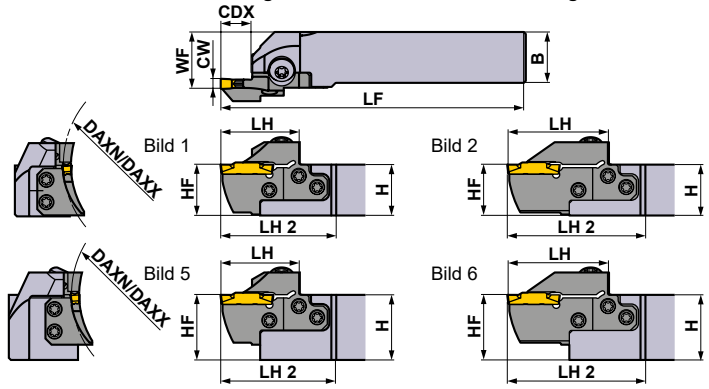
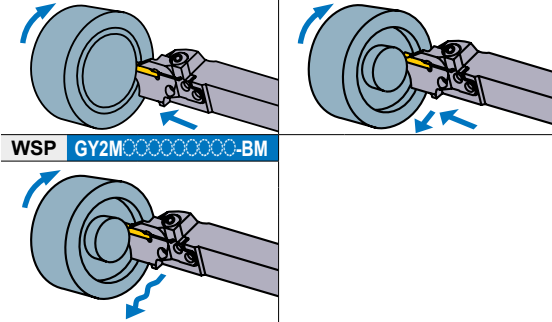
● : Lagerstandard.

EINSTECHEN / ABSTECHEN

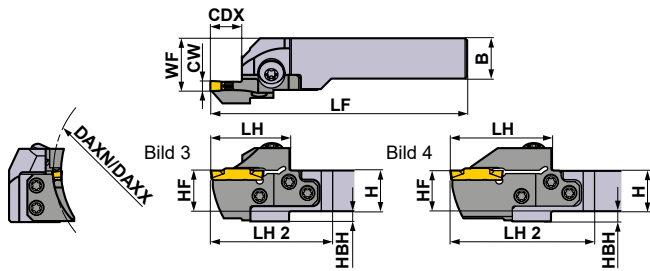

\* Schlüssel : ① : Spannschraube, ② : Schraube für Schwert

ERSATZTEILE			
Halter			
	Spannschraube	Schraube für Schwert 5 St.	Schlüssel*
GYHR/L2020K00-M25R/L	GY06013M (Spannmoment : 6.0N·m)	TS55 (Spannmoment : 5.0N·m)	①TKY30R ②TKY25D
GYHR/L2525M00-M25R/L			
GYHR/L3225P00-M25R/L			
GYHR/L3232P00-M25R/L			

Abb. zeigt Rechtsausführung.

	Abmessungen (mm) *1								Schnittmodus
	H	B	LF	LH	LH 2	HF	WF	HBH	
	20	20	125	39	60	20	26	5	R
	20	20	125	39	60	20	26	5	
	25	25	150	39	57	25	28	—	
	25	25	150	39	57	25	28	—	
	32	25	170	39	57	32	28	—	
	32	25	170	39	57	32	28	—	
	32	32	170	39	57	32	35	—	
	32	32	170	39	57	32	35	—	
	20	20	131	45	66	20	26	5	
	20	20	131	45	66	20	26	5	
	25	25	156	45	63	25	28	—	
	25	25	156	45	63	25	28	—	
	32	25	176	45	63	32	28	—	
	32	25	176	45	63	32	28	—	
	32	32	176	45	63	32	35	—	
	32	32	176	45	63	32	35	—	
	20	20	125	39	60	20	26	5	L
	20	20	125	39	60	20	26	5	
	25	25	150	39	57	25	28	—	
	25	25	150	39	57	25	28	—	
	32	25	170	39	57	32	28	—	
	32	25	170	39	57	32	28	—	
	32	32	170	39	57	32	35	—	
	32	32	170	39	57	32	35	—	
	20	20	131	45	66	20	26	5	
	20	20	131	45	66	20	26	5	
	25	25	156	45	63	25	28	—	
	25	25	156	45	63	25	28	—	
	32	25	176	45	63	32	28	—	
	32	25	176	45	63	32	28	—	
	32	32	176	45	63	32	35	—	
	32	32	176	45	63	32	35	—	

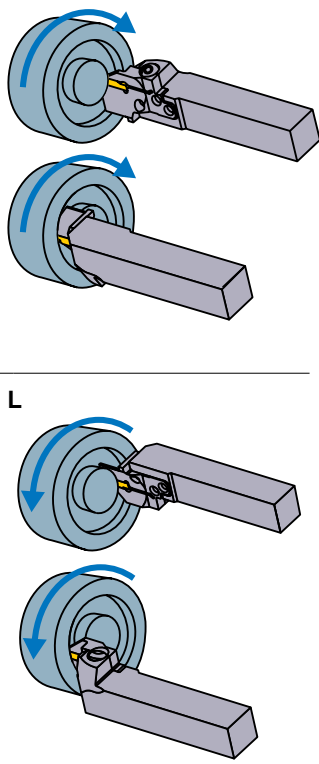

**WSP-Auswahl**

Sitzgröße	<b>Spannbrecher Bezeichnung</b>
F	GY <span style="border: 1px solid black; border-radius: 50%; padding: 2px;">0300/0318/0324</span> F <span style="border: 1px solid black; border-radius: 50%; padding: 2px;">0000</span> — Spannbrecher nachstehend abgebildet

Spannbrecher zum Einstechen/Abstechen > F012, F013					
Sitzgröße	Spannbrecher CW	GU	GS	GM	GFGS
		(Für langspannte Stähle)	(Kleine Vorschübe)	(Mittlere Vorschübe)	(Gehärteter Stahl)
F	3.00mm	●	●	●	●
	3.18mm	●	●	●	●

Multifunktionsspannbrecher > F014, F015					
Sitzgröße	Spannbrecher CW	MF	MS	MM	BM
		(Schichten)	(Kleine Vorschübe)	(Mittlere Vorschübe)	(Kopierdrehen)
F	3.00mm				●
	RE 0.2	●	●	●	
	RE 0.4	●	●	●	
	RE 0.8		●	●	
	3.18mm				●
	RE 0.2	●			
	RE 0.4	●			
	3.24mm	●			

● : Standard-WSP mit Abmessungen

IDENTIFIKATION > F008, F009  
 SCHNITTBEDINGUNGEN > F104  
 SICHERHEITSHINWEISE > F106

# GY SERIE (AXIALEINSTECHEN)

4

00° Ausführung

Hinweis 1) Modulare Schwerter und modulare Halter bitte separat bestellen.  
Hinweis 2) Spitze Modul in Rechtsausführung für den Halter in Rechtsausführung und Modul in Linksausführung für den Halter in Linksausführung verwenden.

WSP	GY2M <sup>GS</sup>	WSP	GY2G <sup>MF</sup>
WSP	GY2M <sup>GU</sup>	WSP	GY2M <sup>MS</sup>
WSP	GY1 <sup>GM</sup> <sub>GFGS</sub>	WSP	GY2M <sup>MM</sup>

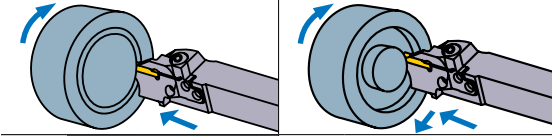

WSP GY2M<sup>BM</sup>



Abb. zeigt Rechtsausführung.

Sitzgröße	Abmessungen (mm)				Typ	Ausführung (R/L)	Bestellbezeichnung				Bild
	CW	DAXN	DAXX	CDX			Halter	Lager	Modulares Schwert	Lager	
F	3.00 3.18 3.24	180	250	12	Modular	R	GYHR2020K00-M25R	●	GYM25RD-F12-180	●	3
					Modular	L	GYHL2020K00-M25L	●	GYM25LD-F12-180	●	3
					Modular	R	GYHR2525M00-M25R	●	GYM25RD-F12-180	●	1
					Modular	L	GYHL2525M00-M25L	●	GYM25LD-F12-180	●	1
		Modular	R	GYHR3225P00-M25R	●	GYM25RD-F12-180	●	5			
		Modular	L	GYHL3225P00-M25L	●	GYM25LD-F12-180	●	5			
		Modular	R	GYHR3232P00-M25R	●	GYM25RD-F12-180	●	5			
		Modular	L	GYHL3232P00-M25L	●	GYM25LD-F12-180	●	5			
	225	999	20 * 2	12	Modular	R	GYHR2020K00-M25R	●	GYM25RD-F20-180	●	4
					Modular	L	GYHL2020K00-M25L	●	GYM25LD-F20-180	●	4
					Modular	R	GYHR2525M00-M25R	●	GYM25RD-F20-180	●	2
					Modular	L	GYHL2525M00-M25L	●	GYM25LD-F20-180	●	2
			Modular	R	GYHR3225P00-M25R	●	GYM25RD-F20-180	●	6		
			Modular	L	GYHL3225P00-M25L	●	GYM25LD-F20-180	●	6		
			Modular	R	GYHR3232P00-M25R	●	GYM25RD-F20-180	●	6		
			Modular	L	GYHL3232P00-M25L	●	GYM25LD-F20-180	●	6		
20 * 2		12	12	Modular	R	GYHR2020K00-M25R	●	GYM25RD-F12-225	●	3	
				Modular	L	GYHL2020K00-M25L	●	GYM25LD-F12-225	●	3	
				Modular	R	GYHR2525M00-M25R	●	GYM25RD-F12-225	●	1	
				Modular	L	GYHL2525M00-M25L	●	GYM25LD-F12-225	●	1	
		Modular	R	GYHR3225P00-M25R	●	GYM25RD-F12-225	●	5			
		Modular	L	GYHL3225P00-M25L	●	GYM25LD-F12-225	●	5			
		Modular	R	GYHR3232P00-M25R	●	GYM25RD-F12-225	●	5			
		Modular	L	GYHL3232P00-M25L	●	GYM25LD-F12-225	●	5			
20 * 2				Modular	R	GYHR2020K00-M25R	●	GYM25RD-F20-225	●	4	
				Modular	L	GYHL2020K00-M25L	●	GYM25LD-F20-225	●	4	
				Modular	R	GYHR2525M00-M25R	●	GYM25RD-F20-225	●	2	
				Modular	L	GYHL2525M00-M25L	●	GYM25LD-F20-225	●	2	
Modular	R	GYHR3225P00-M25R	●	GYM25RD-F20-225	●	6					
Modular	L	GYHL3225P00-M25L	●	GYM25LD-F20-225	●	6					
Modular	R	GYHR3232P00-M25R	●	GYM25RD-F20-225	●	6					
Modular	L	GYHL3232P00-M25L	●	GYM25LD-F20-225	●	6					

\*1 Die dargestellten Abmessungen gelten bei der Verwendung von Standard-WSP. Wenn andere WSP-Geometrien verwendet werden, können die Werte für LF, LH, LH2, und WF variieren.

\*2 Die maximale Einstechtiefe (CDX) hängt von der verwendeten Schneidplatte ab. Zur maximalen Einstechtiefe (CDX) bei verschiedenen Schneidplatten siehe Seite F012–F015.

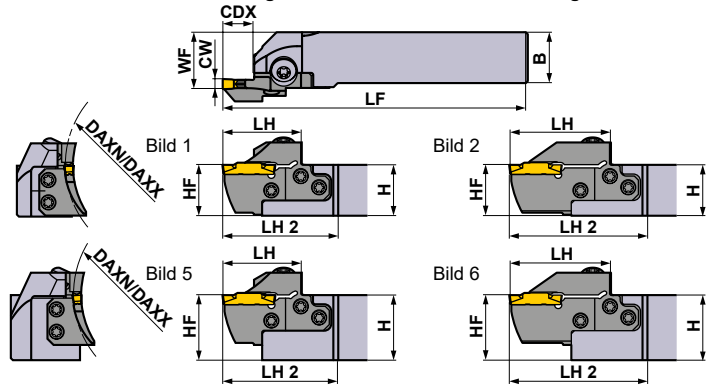
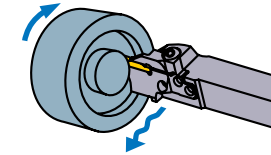
● : Lagerstandard.

EINSTECHEN / ABSTECHEN

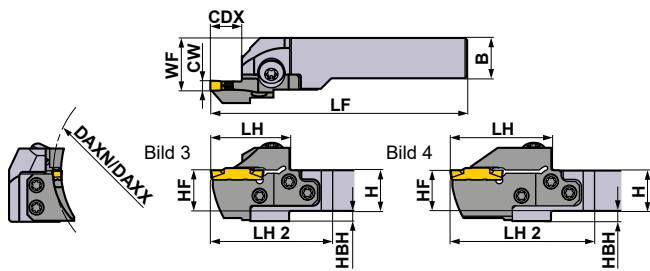

\* Schlüssel : ① : Spannschraube, ② : Schraube für Schwert

ERSATZTEILE			
Halter			
	Spannschraube	Schraube für Schwert 5 St.	Schlüssel*
GYHR/L2020K00-M25R/L			
GYHR/L2525M00-M25R/L	GY06013M (Spannmoment : 6.0N·m)	TS55 (Spannmoment : 5.0N·m)	①TKY30R ②TKY25D
GYHR/L3225P00-M25R/L			
GYHR/L3232P00-M25R/L			

Abb. zeigt Rechtsausführung.

	Abmessungen (mm) *1								Schnittmodus
	H	B	LF	LH	LH 2	HF	WF	HBH	
	20	20	125	39	60	20	26	5	R
	20	20	125	39	60	20	26	5	
	25	25	150	39	57	25	28	—	
	25	25	150	39	57	25	28	—	
	32	25	170	39	57	32	28	—	
	32	25	170	39	57	32	28	—	
	32	32	170	39	57	32	35	—	
	32	32	170	39	57	32	35	—	
	20	20	131	45	66	20	26	5	
	20	20	131	45	66	20	26	5	
	25	25	156	45	63	25	28	—	
	25	25	156	45	63	25	28	—	
	32	25	176	45	63	32	28	—	
	32	25	176	45	63	32	28	—	
	32	32	176	45	63	32	35	—	
	32	32	176	45	63	32	35	—	
	20	20	125	39	60	20	26	5	L
	20	20	125	39	60	20	26	5	
	25	25	150	39	57	25	28	—	
	25	25	150	39	57	25	28	—	
	32	25	170	39	57	32	28	—	
	32	25	170	39	57	32	28	—	
	32	32	170	39	57	32	35	—	
	32	32	170	39	57	32	35	—	
	20	20	131	45	66	20	26	5	
	20	20	131	45	66	20	26	5	
	25	25	156	45	63	25	28	—	
	25	25	156	45	63	25	28	—	
	32	25	176	45	63	32	28	—	
	32	25	176	45	63	32	28	—	
	32	32	176	45	63	32	35	—	
	32	32	176	45	63	32	35	—	

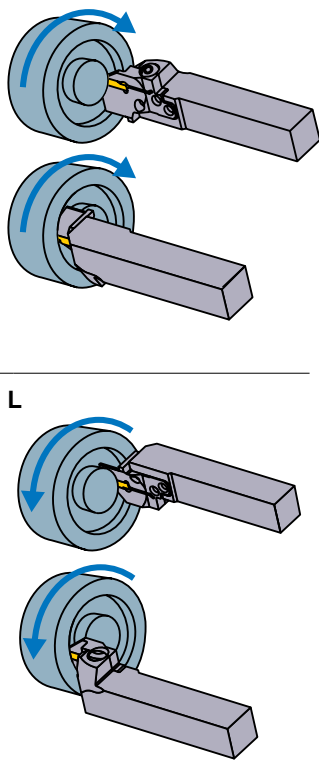

**WSP-Auswahl**

Sitzgröße	<b>Spannbrecher Bezeichnung</b>
F	GY <span style="border: 1px solid black; border-radius: 50%; padding: 2px;">0300/0318/0324F</span> <span style="border: 1px solid black; border-radius: 50%; padding: 2px;">0300</span> — Spannbrecher nachstehend abgebildet

Spannbrecher zum Einstechen/Abstechen > F012, F013					
Sitzgröße	Spannbrecher CW	GU	GS	GM	GFGS
		(Für langspannte Stähle)	(Kleine Vorschübe)	(Mittlere Vorschübe)	(Gehärteter Stahl)
F	3.00mm	●	●	●	●
	3.18mm	●	●	●	●

Multifunktionsspannbrecher > F014, F015					
Sitzgröße	Spannbrecher CW	MF	MS	MM	BM
		(Schichten)	(Kleine Vorschübe)	(Mittlere Vorschübe)	(Kopierdrehen)
F	3.00mm				●
	RE 0.2	●	●	●	
	RE 0.4	●	●	●	
	RE 0.8			●	
	3.18mm				●
	RE 0.2	●			
	RE 0.4	●			
	3.24mm	●			

● : Standard-WSP mit Abmessungen

IDENTIFIKATION > F008, F009  
 SCHNITTBEDINGUNGEN > F104  
 SICHERHEITSHINWEISE > F106



# GY SERIE (AXIALEINSTECHEN)

4

00° Ausführung

Hinweis 1) Modulare Schwerter und modulare Halter bitte separat bestellen.  
Hinweis 2) Spitze Modul in Rechtsausführung für den Halter in Rechtsausführung und Modul in Linksausführung für den Halter in Linksausführung verwenden.

WSP	GY2M <sup>GS</sup>	WSP	GY2G <sup>MF</sup>
WSP	GY2M <sup>GU</sup>	WSP	GY2M <sup>MS</sup>
WSP	GY1 <sup>GM</sup>	WSP	GY2M <sup>MM</sup>



Abb. zeigt Rechtsausführung.

Sitzgröße	Abmessungen (mm)				Typ	Ausführung (R/L)	Bestellbezeichnung				Bild
	CW	DAXN	DAXX	CDX			Halter	Lager	Modulares Schwert	Lager	
G	4.00	40	50	14	Modular	R	GYHR2020K00-M25R	●	GYM25RD-G14-040	●	3
					L	GYHL2020K00-M25L	●	GYM25LD-G14-040	●	3	
					R	GYHR2525M00-M25R	●	GYM25RD-G14-040	●	1	
					L	GYHL2525M00-M25L	●	GYM25LD-G14-040	●	1	
		R	GYHR3225P00-M25R	●	GYM25RD-G14-040	●	5				
		L	GYHL3225P00-M25L	●	GYM25LD-G14-040	●	5				
		R	GYHR3232P00-M25R	●	GYM25RD-G14-040	●	5				
		L	GYHL3232P00-M25L	●	GYM25LD-G14-040	●	5				
	4.24	50	60	14	Modular	R	GYHR2020K00-M25R	●	GYM25RD-G14-050	●	3
					L	GYHL2020K00-M25L	●	GYM25LD-G14-050	●	3	
					R	GYHR2525M00-M25R	●	GYM25RD-G14-050	●	1	
					L	GYHL2525M00-M25L	●	GYM25LD-G14-050	●	1	
		R	GYHR3225P00-M25R	●	GYM25RD-G14-050	●	5				
		L	GYHL3225P00-M25L	●	GYM25LD-G14-050	●	5				
		R	GYHR3232P00-M25R	●	GYM25RD-G14-050	●	5				
		L	GYHL3232P00-M25L	●	GYM25LD-G14-050	●	5				
	60	85	14	Modular	R	GYHR2020K00-M25R	●	GYM25RD-G14-060	●	3	
				L	GYHL2020K00-M25L	●	GYM25LD-G14-060	●	3		
				R	GYHR2525M00-M25R	●	GYM25RD-G14-060	●	1		
				L	GYHL2525M00-M25L	●	GYM25LD-G14-060	●	1		
R		GYHR3225P00-M25R	●	GYM25RD-G14-060	●	5					
L		GYHL3225P00-M25L	●	GYM25LD-G14-060	●	5					
R		GYHR3232P00-M25R	●	GYM25RD-G14-060	●	5					
L		GYHL3232P00-M25L	●	GYM25LD-G14-060	●	5					
25 *2			Modular	R	GYHR2020K00-M25R	●	GYM25RD-G25-060	●	4		
			L	GYHL2020K00-M25L	●	GYM25LD-G25-060	●	4			
			R	GYHR2525M00-M25R	●	GYM25RD-G25-060	●	2			
			L	GYHL2525M00-M25L	●	GYM25LD-G25-060	●	2			
R	GYHR3225P00-M25R	●	GYM25RD-G25-060	●	6						
L	GYHL3225P00-M25L	●	GYM25LD-G25-060	●	6						
R	GYHR3232P00-M25R	●	GYM25RD-G25-060	●	6						
L	GYHL3232P00-M25L	●	GYM25LD-G25-060	●	6						

\*1 Die dargestellten Abmessungen gelten bei der Verwendung von Standard-WSP. Wenn andere WSP-Geometrien verwendet werden, können die Werte für LF, LH, LH2, und WF variieren.

\*2 Die maximale Einstechtiefe (CDX) hängt von der verwendeten Schneidplatte ab. Zur maximalen Einstechtiefe (CDX) bei verschiedenen Schneidplatten siehe Seite F012–F015.

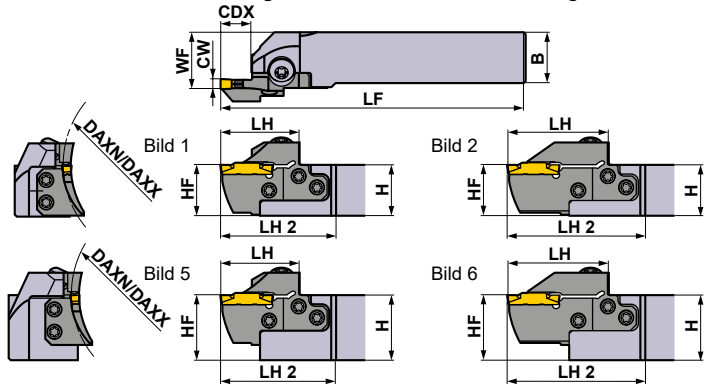
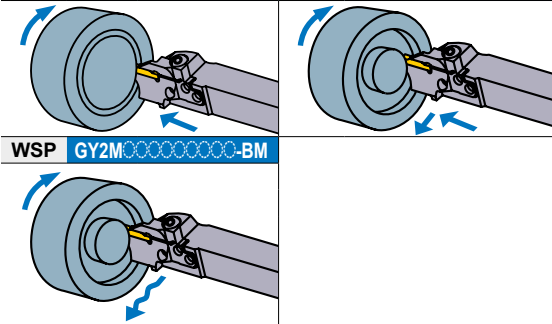
● : Lagerstandard.



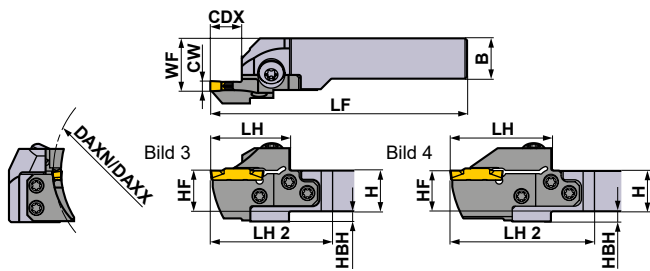

\* Schlüssel : ① : Spannschraube, ② : Schraube für Schwert

### ERSATZTEILE

Halter			
	Spannschraube	Schraube für Schwert 5 St.	Schlüssel*
GYHR/L2020K00-M25R/L	GY06013M (Spannmoment : 6.0N·m)	TS55 (Spannmoment : 5.0N·m)	①TKY30R ②TKY25D
GYHR/L2525M00-M25R/L			
GYHR/L3225P00-M25R/L			
GYHR/L3232P00-M25R/L			

Abb. zeigt Rechtsausführung.

	Abmessungen (mm) *1								Schnittmodus
	H	B	LF	LH	LH 2	HF	WF	HBH	
	20	20	125	39	60	20	26	5	<b>R</b> 
	20	20	125	39	60	20	26	5	
	25	25	150	39	57	25	28	—	
	25	25	150	39	57	25	28	—	
	32	25	170	39	57	32	28	—	
	32	25	170	39	57	32	28	—	
	32	32	170	39	57	32	35	—	
	32	32	170	39	57	32	35	—	
	20	20	125	39	60	20	26	5	
	20	20	125	39	60	20	26	5	
	25	25	150	39	57	25	28	—	
	25	25	150	39	57	25	28	—	
	32	25	170	39	57	32	28	—	
	32	25	170	39	57	32	28	—	
	32	32	170	39	57	32	35	—	
	32	32	170	39	57	32	35	—	
	20	20	125	39	60	20	26	5	<b>L</b> 
	20	20	125	39	60	20	26	5	
	25	25	150	39	57	25	28	—	
	25	25	150	39	57	25	28	—	
	32	25	170	39	57	32	28	—	
	32	25	170	39	57	32	28	—	
	32	32	170	39	57	32	35	—	
	32	32	170	39	57	32	35	—	
	20	20	136	50	71	20	26	5	
	20	20	136	50	71	20	26	5	
	25	25	161	50	68	25	28	—	
	25	25	161	50	68	25	28	—	
	32	25	181	50	68	32	28	—	
	32	25	181	50	68	32	28	—	
	32	32	181	50	68	32	35	—	
	32	32	181	50	68	32	35	—	

### WSP-Auswahl

Sitzgröße	<b>Spannbrecher Bezeichnung</b>
G	GY○○0400/0424G○○○○—Spannbrecher nachstehend abgebildet

Spannbrecher zum Einstechen/Abstechen > F012, F013					
Sitzgröße	Spannbrecher	GU	GS	GM	GFGS
		(Für langspannte Stähle)	(Kleine Vorschübe)	(Mittlere Vorschübe)	(Cehärteter Stahl)
G	4.00mm	●	●	●	●

Multifunktionsspannbrecher > F014, F015					
Sitzgröße	Spannbrecher	MF	MS	MM	BM
		(Schichten)	(Kleine Vorschübe)	(Mittlere Vorschübe)	(Kopierdrehen)
					Kugelform
G	4.00mm	●	●	●	●
	RE 0.2	●	●	●	●
	RE 0.4	●	●	●	●
	RE 0.8	●	●	●	●
	4.24mm	●			

● : Standard-WSP mit Abmessungen

# GY SERIE (AXIALEINSTECHEN)

4

00° Ausführung

Hinweis 1) Modulare Schwerter und modulare Halter bitte separat bestellen.  
Hinweis 2) Spitze Modul in Rechtsausführung für den Halter in Rechtsausführung und Modul in Linksausführung für den Halter in Linksausführung verwenden.

WSP	GY2M <sup>GS</sup>	WSP	GY2G <sup>MF</sup>
WSP	GY2M <sup>GU</sup>	WSP	GY2M <sup>MS</sup>
WSP	GY1 <sup>GM</sup>	WSP	GY2M <sup>MM</sup>

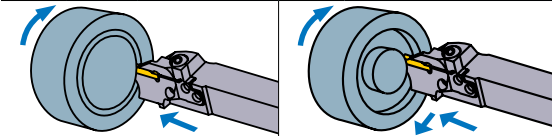

WSP GY2M<sup>BM</sup>



Abb. zeigt Rechtsausführung.

Sitzgröße	Abmessungen (mm)				Typ	Ausführung (R/L)	Bestellbezeichnung				Bild
	CW	DAXN	DAXX	CDX			Halter	Lager	Modulares Schwert	Lager	
G	4.00	85	125	14	Modular	R	GYHR2020K00-M25R	●	GYM25RD-G14-085	●	3
					Modular	L	GYHL2020K00-M25L	●	GYM25LD-G14-085	●	3
					Modular	R	GYHR2525M00-M25R	●	GYM25RD-G14-085	●	1
					Modular	L	GYHL2525M00-M25L	●	GYM25LD-G14-085	●	1
				Modular	R	GYHR3225P00-M25R	●	GYM25RD-G14-085	●	5	
				Modular	L	GYHL3225P00-M25L	●	GYM25LD-G14-085	●	5	
				Modular	R	GYHR3232P00-M25R	●	GYM25RD-G14-085	●	5	
				Modular	L	GYHL3232P00-M25L	●	GYM25LD-G14-085	●	5	
	25 *2	Modular	R	GYHR2020K00-M25R	●	GYM25RD-G25-085	●	4			
		Modular	L	GYHL2020K00-M25L	●	GYM25LD-G25-085	●	4			
		Modular	R	GYHR2525M00-M25R	●	GYM25RD-G25-085	●	2			
		Modular	L	GYHL2525M00-M25L	●	GYM25LD-G25-085	●	2			
	4.24	125	200	14	Modular	R	GYHR2020K00-M25R	●	GYM25RD-G14-125	●	3
					Modular	L	GYHL2020K00-M25L	●	GYM25LD-G14-125	●	3
					Modular	R	GYHR2525M00-M25R	●	GYM25RD-G14-125	●	1
					Modular	L	GYHL2525M00-M25L	●	GYM25LD-G14-125	●	1
				Modular	R	GYHR3225P00-M25R	●	GYM25RD-G14-125	●	5	
				Modular	L	GYHL3225P00-M25L	●	GYM25LD-G14-125	●	5	
				Modular	R	GYHR3232P00-M25R	●	GYM25RD-G14-125	●	5	
				Modular	L	GYHL3232P00-M25L	●	GYM25LD-G14-125	●	5	
25 *2	Modular	R	GYHR2020K00-M25R	●	GYM25RD-G25-125	●	4				
	Modular	L	GYHL2020K00-M25L	●	GYM25LD-G25-125	●	4				
	Modular	R	GYHR2525M00-M25R	●	GYM25RD-G25-125	●	2				
	Modular	L	GYHL2525M00-M25L	●	GYM25LD-G25-125	●	2				
Modular	R	GYHR3225P00-M25R	●	GYM25RD-G25-125	●	6					
Modular	L	GYHL3225P00-M25L	●	GYM25LD-G25-125	●	6					
Modular	R	GYHR3232P00-M25R	●	GYM25RD-G25-125	●	6					
Modular	L	GYHL3232P00-M25L	●	GYM25LD-G25-125	●	6					

\*1 Die dargestellten Abmessungen gelten bei der Verwendung von Standard-WSP. Wenn andere WSP-Geometrien verwendet werden, können die Werte für LF, LH, LH2, und WF variieren.

\*2 Die maximale Einstechtiefe (CDX) hängt von der verwendeten Schneidplatte ab. Zur maximalen Einstechtiefe (CDX) bei verschiedenen Schneidplatten siehe Seite F012–F015.

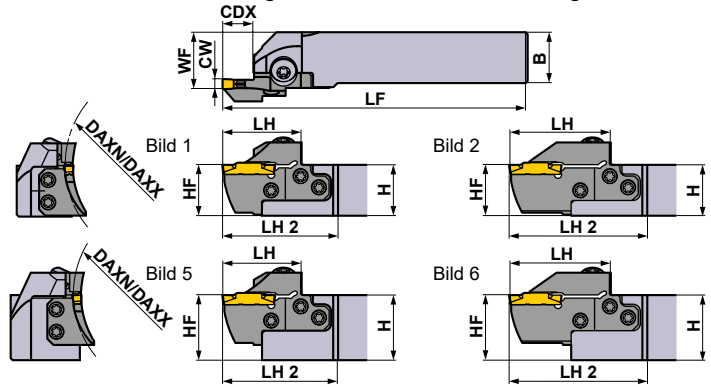
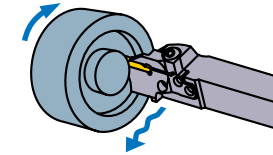
● : Lagerstandard.

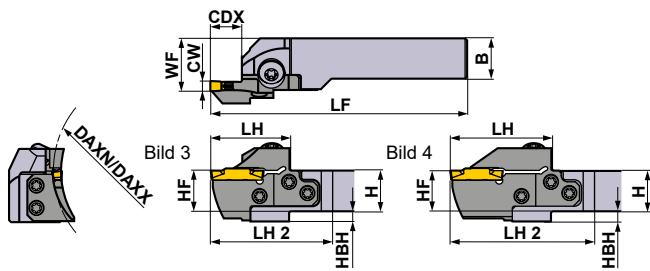

\* Schlüssel : ① : Spannschraube, ② : Schraube für Schwert

### ERSATZTEILE



Halter		 5 St.	
GYHR/L2020K00-M25R/L			
GYHR/L2525M00-M25R/L	GY06013M (Spannmoment : 6.0N·m)	TS55 (Spannmoment : 5.0N·m)	①TKY30R ②TKY25D
GYHR/L3225P00-M25R/L			
GYHR/L3232P00-M25R/L			

Abb. zeigt Rechtsausführung.

	Abmessungen (mm) *1								Schnittmodus
	H	B	LF	LH	LH 2	HF	WF	HBH	
	20	20	125	39	60	20	26	5	<b>R</b>
	20	20	125	39	60	20	26	5	
	25	25	150	39	57	25	28	—	
	25	25	150	39	57	25	28	—	
	32	25	170	39	57	32	28	—	
	32	25	170	39	57	32	28	—	
	32	32	170	39	57	32	35	—	
	32	32	170	39	57	32	35	—	
	20	20	136	50	71	20	26	5	<b>L</b>
	20	20	136	50	71	20	26	5	
	25	25	161	50	68	25	28	—	
	25	25	161	50	68	25	28	—	
	32	25	181	50	68	32	28	—	
	32	25	181	50	68	32	28	—	
	32	32	181	50	68	32	35	—	
	32	32	181	50	68	32	35	—	

### WSP-Auswahl

Sitzgröße	Spannbrecher Bezeichnung
G	GY○○0400/0424G○○○○—Spannbrecher nachstehend abgebildet

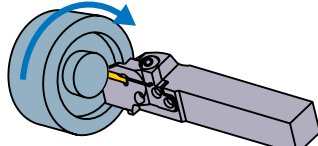
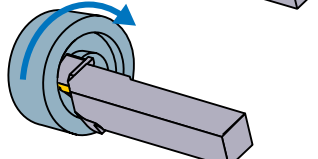
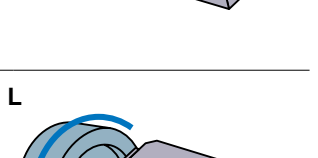
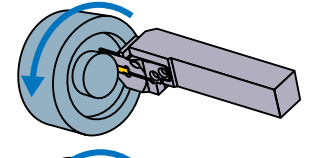
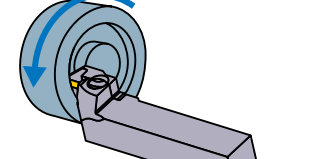
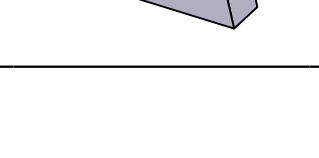
Spannbrecher zum Einstechen/Abstechen > F012, F013					
Sitzgröße	Spannbrecher	GU	GS	GM	GFGS
		(Für langspannte Stähle)	(Kleine Vorschübe)	(Mittlere Vorschübe)	(Cehärteter Stahl)
G	4.00mm	●	●	●	●

Multifunktionsspannbrecher > F014, F015					
Sitzgröße	Spannbrecher	MF	MS	MM	BM
		(Schichten)	(Kleine Vorschübe)	(Mittlere Vorschübe)	(Kopierdrehen)
					Kugelform
G	4.00mm	●	●	●	●
	RE 0.2	●	●	●	●
	RE 0.4	●	●	●	●
	RE 0.8	●	●	●	●
	4.24mm	●			

● : Standard-WSP mit Abmessungen

EINSTECHEN / ABSTECHEN

## GY SERIE (AXIALEINSTECHEN)

### 4

### 00° Ausführung

WSP	GY2M <sup>GS</sup>	WSP	GY2G <sup>MF</sup>
WSP	GY2M <sup>GU</sup>	WSP	GY2M <sup>MS</sup>
WSP	GY1 <sup>GM</sup>	WSP	GY2M <sup>MM</sup>

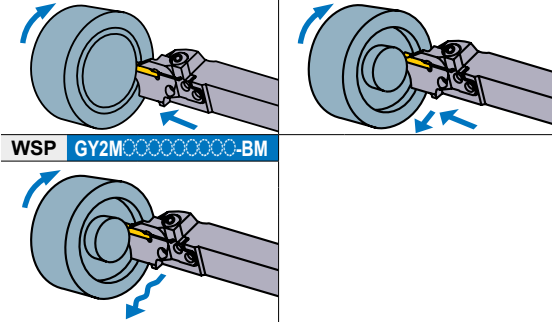

Hinweis 1) Modulare Schwerter und modulare Halter bitte separat bestellen.  
Hinweis 2) Bitte Modul in Rechtsausführung für den Halter in Rechtsausführung und Modul in Linksausführung für den Halter in Linksausführung verwenden.



Abb. zeigt Rechtsausführung.

Sitzgröße	Abmessungen (mm)				Typ	Ausführung (R/L)	Bestellbezeichnung				Bild
	CW	DAXN	DAXX	CDX			Holder	Lager	Modulares Schwert	Lager	
G	4.00	180	280	14	Modular	R	GYHR2020K00-M25R	●	GYM25RD-G14-180	●	3
					Modular	L	GYHL2020K00-M25L	●	GYM25LD-G14-180	●	3
					Modular	R	GYHR2525M00-M25R	●	GYM25RD-G14-180	●	1
					Modular	L	GYHL2525M00-M25L	●	GYM25LD-G14-180	●	1
					Modular	R	GYHR3225P00-M25R	●	GYM25RD-G14-180	●	5
					Modular	L	GYHL3225P00-M25L	●	GYM25LD-G14-180	●	5
					Modular	R	GYHR3232P00-M25R	●	GYM25RD-G14-180	●	5
					Modular	L	GYHL3232P00-M25L	●	GYM25LD-G14-180	●	5
	4.24	25 * 2			Modular	R	GYHR2020K00-M25R	●	GYM25RD-G25-180	●	4
					Modular	L	GYHL2020K00-M25L	●	GYM25LD-G25-180	●	4
					Modular	R	GYHR2525M00-M25R	●	GYM25RD-G25-180	●	2
					Modular	L	GYHL2525M00-M25L	●	GYM25LD-G25-180	●	2
					Modular	R	GYHR3225P00-M25R	●	GYM25RD-G25-180	●	6
					Modular	L	GYHL3225P00-M25L	●	GYM25LD-G25-180	●	6
					Modular	R	GYHR3232P00-M25R	●	GYM25RD-G25-180	●	6
					Modular	L	GYHL3232P00-M25L	●	GYM25LD-G25-180	●	6
		250	999	14	Modular	R	GYHR2020K00-M25R	●	GYM25RD-G14-250	●	3
					Modular	L	GYHL2020K00-M25L	●	GYM25LD-G14-250	●	3
					Modular	R	GYHR2525M00-M25R	●	GYM25RD-G14-250	●	1
					Modular	L	GYHL2525M00-M25L	●	GYM25LD-G14-250	●	1
Modular					R	GYHR3225P00-M25R	●	GYM25RD-G14-250	●	5	
Modular					L	GYHL3225P00-M25L	●	GYM25LD-G14-250	●	5	
Modular					R	GYHR3232P00-M25R	●	GYM25RD-G14-250	●	5	
Modular					L	GYHL3232P00-M25L	●	GYM25LD-G14-250	●	5	
	25 * 2			Modular	R	GYHR2020K00-M25R	●	GYM25RD-G25-250	●	4	
				Modular	L	GYHL2020K00-M25L	●	GYM25LD-G25-250	●	4	
				Modular	R	GYHR2525M00-M25R	●	GYM25RD-G25-250	●	2	
				Modular	L	GYHL2525M00-M25L	●	GYM25LD-G25-250	●	2	
				Modular	R	GYHR3225P00-M25R	●	GYM25RD-G25-250	●	6	
				Modular	L	GYHL3225P00-M25L	●	GYM25LD-G25-250	●	6	
				Modular	R	GYHR3232P00-M25R	●	GYM25RD-G25-250	●	6	
				Modular	L	GYHL3232P00-M25L	●	GYM25LD-G25-250	●	6	

\*1 Die dargestellten Abmessungen gelten bei der Verwendung von Standard-WSP. Wenn andere WSP-Geometrien verwendet werden, können die Werte für LF, LH, LH2, und WF variieren.

\*2 Die maximale Einstechtiefe (CDX) hängt von der verwendeten Schneidplatte ab. Zur maximalen Einstechtiefe (CDX) bei verschiedenen Schneidplatten siehe Seite F012–F015.

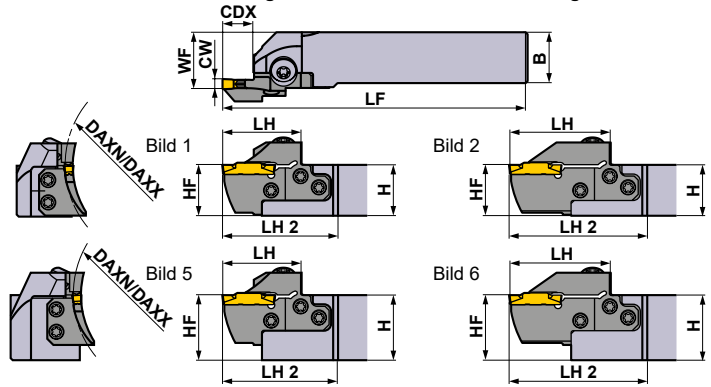
● : Lagerstandard.

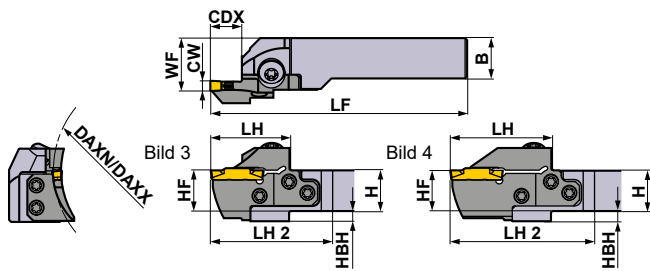

\* Schlüssel : ① : Spannschraube, ② : Schraube für Schwert

### ERSATZTEILE

Halter			
	Spannschraube	Schraube für Schwert 5 St.	Schlüssel*
GYHR/L2020K00-M25R/L	GY06013M (Spannmoment : 6.0N·m)	TS55 (Spannmoment : 5.0N·m)	①TKY30R ②TKY25D
GYHR/L2525M00-M25R/L			
GYHR/L3225P00-M25R/L			
GYHR/L3232P00-M25R/L			

Abb. zeigt Rechtsausführung.

	Abmessungen (mm) *1								Schnittmodus
	H	B	LF	LH	LH 2	HF	WF	HBH	
	20	20	125	39	60	20	26	5	<b>R</b> 
	20	20	125	39	60	20	26	5	
	25	25	150	39	57	25	28	—	
	25	25	150	39	57	25	28	—	
	32	25	170	39	57	32	28	—	
	32	25	170	39	57	32	28	—	
	32	32	170	39	57	32	35	—	
	32	32	170	39	57	32	35	—	
	20	20	136	50	71	20	26	5	
	20	20	136	50	71	20	26	5	
	25	25	161	50	68	25	28	—	
	25	25	161	50	68	25	28	—	
	32	25	181	50	68	32	28	—	
	32	25	181	50	68	32	28	—	
	32	32	181	50	68	32	35	—	
	32	32	181	50	68	32	35	—	
	20	20	125	39	60	20	26	5	<b>L</b> 
	20	20	125	39	60	20	26	5	
	25	25	150	39	57	25	28	—	
	25	25	150	39	57	25	28	—	
	32	25	170	39	57	32	28	—	
	32	25	170	39	57	32	28	—	
	32	32	170	39	57	32	35	—	
	32	32	170	39	57	32	35	—	
	20	20	136	50	71	20	26	5	
	20	20	136	50	71	20	26	5	
	25	25	161	50	68	25	28	—	
	25	25	161	50	68	25	28	—	
	32	25	181	50	68	32	28	—	
	32	25	181	50	68	32	28	—	
	32	32	181	50	68	32	35	—	
	32	32	181	50	68	32	35	—	

### WSP-Auswahl

Sitzgröße	<b>Spannbrecher Bezeichnung</b>
G	GY○○0400/0424G○○○○—Spannbrecher nachstehend abgebildet

Spannbrecher zum Einstechen/Abstechen > F012, F013					
Sitzgröße	Spannbrecher	GU (Für langspanne Stähle)	GS (Kleine Vorschübe)	GM (Mittlere Vorschübe)	GFGS (Gehärteter Stahl)
G	4.00mm	●	●	●	●

Multifunktionsspannbrecher > F014, F015					
Sitzgröße	Spannbrecher	MF (Schlichten)	MS (Kleine Vorschübe)	MM (Mittlere Vorschübe)	BM (Kopierdrehen) Kugelform
G	4.00mm	●	●	●	●
	RE 0.2	●	●	●	●
	RE 0.4	●	●	●	●
	RE 0.8	●	●	●	●
	4.24mm	●			

● : Standard-WSP mit Abmessungen

# GY SERIE (AXIALEINSTECHEN)

4

00° Ausführung

Hinweis 1) Modulare Schwerter und modulare Halter bitte separat bestellen.  
Hinweis 2) Spitze Modul in Rechtsausführung für den Halter in Rechtsausführung und Modul in Linksausführung für den Halter in Linksausführung verwenden.

WSP	GY2M <sup>GS</sup> <sub>GM</sub>	WSP	GY2G <sup>MF</sup>
WSP	GY2M <sup>GU</sup>	WSP	GY2M <sup>MS</sup>
WSP	GY1 <sup>GM</sup> <sub>GFGS</sub>	WSP	GY2M <sup>MM</sup>

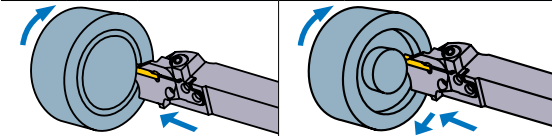

WSP GY2M<sup>BM</sup>



Abb. zeigt Rechtsausführung.

Sitzgröße	Abmessungen (mm)				Typ	Ausführung (R/L)	Bestellbezeichnung				Bild
	CW	DAXN	DAXX	CDX			Halter	Lager	Modulares Schwert	Lager	
H	4.75 5.00 5.24	50	60	14	Modular	R	GYHR2020K00-M25R	●	GYM25RD-H14-050	●	3
					Modular	L	GYHL2020K00-M25L	●	GYM25LD-H14-050	●	3
					Modular	R	GYHR2525M00-M25R	●	GYM25RD-H14-050	●	1
					Modular	L	GYHL2525M00-M25L	●	GYM25LD-H14-050	●	1
		Modular	R	GYHR3225P00-M25R	●	GYM25RD-H14-050	●	5			
		Modular	L	GYHL3225P00-M25L	●	GYM25LD-H14-050	●	5			
		Modular	R	GYHR3232P00-M25R	●	GYM25RD-H14-050	●	5			
		Modular	L	GYHL3232P00-M25L	●	GYM25LD-H14-050	●	5			
	60	85	14	Modular	R	GYHR2020K00-M25R	●	GYM25RD-H14-060	●	3	
				Modular	L	GYHL2020K00-M25L	●	GYM25LD-H14-060	●	3	
				Modular	R	GYHR2525M00-M25R	●	GYM25RD-H14-060	●	1	
				Modular	L	GYHL2525M00-M25L	●	GYM25LD-H14-060	●	1	
		Modular	R	GYHR3225P00-M25R	●	GYM25RD-H14-060	●	5			
		Modular	L	GYHL3225P00-M25L	●	GYM25LD-H14-060	●	5			
		Modular	R	GYHR3232P00-M25R	●	GYM25RD-H14-060	●	5			
		Modular	L	GYHL3232P00-M25L	●	GYM25LD-H14-060	●	5			
25 *2			Modular	R	GYHR2020K00-M25R	●	GYM25RD-H25-060	●	4		
			Modular	L	GYHL2020K00-M25L	●	GYM25LD-H25-060	●	4		
			Modular	R	GYHR2525M00-M25R	●	GYM25RD-H25-060	●	2		
			Modular	L	GYHL2525M00-M25L	●	GYM25LD-H25-060	●	2		
Modular	R	GYHR3225P00-M25R	●	GYM25RD-H25-060	●	6					
Modular	L	GYHL3225P00-M25L	●	GYM25LD-H25-060	●	6					
Modular	R	GYHR3232P00-M25R	●	GYM25RD-H25-060	●	6					
Modular	L	GYHL3232P00-M25L	●	GYM25LD-H25-060	●	6					

\*1 Die dargestellten Abmessungen gelten bei der Verwendung von Standard-WSP. Wenn andere WSP-Geometrien verwendet werden, können die Werte für LF, LH, LH2, und WF variieren.  
\*2 Die maximale Einstechtiefe (CDX) hängt von der verwendeten Schneidplatte ab. Zur maximalen Einstechtiefe (CDX) bei verschiedenen Schneidplatten siehe Seite F012–F015.

● : Lagerstandard.

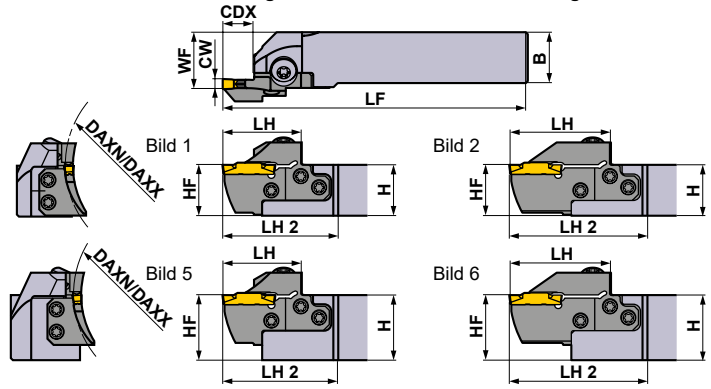
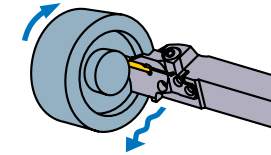
EINSTECHEN / ABSTECHEN



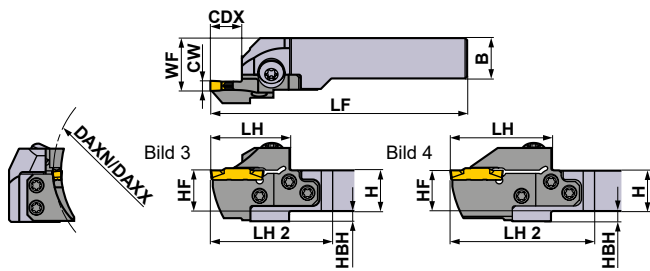

\* Schlüssel : ① : Spannschraube, ② : Schraube für Schwert

ERSATZTEILE			
Halter		5 St.	
	Spannschraube	Schraube für Schwert	Schlüssel*
GYHR/L2020K00-M25R/L	GY06013M (Spannmoment : 6.0N·m)	TS55 (Spannmoment : 5.0N·m)	①TKY30R ②TKY25D
GYHR/L2525M00-M25R/L			
GYHR/L3225P00-M25R/L			
GYHR/L3232P00-M25R/L			

Abb. zeigt Rechtsausführung.

	Abmessungen (mm) *1								Schnittmodus
	H	B	LF	LH	LH 2	HF	WF	HBH	
	20	20	125	39	60	20	26	5	<b>R</b>
	20	20	125	39	60	20	26	5	
	25	25	150	39	57	25	28	—	
	25	25	150	39	57	25	28	—	
	32	25	170	39	57	32	28	—	
	32	25	170	39	57	32	28	—	
	32	32	170	39	57	32	35	—	
	32	32	170	39	57	32	35	—	
	20	20	125	39	60	20	26	5	<b>L</b>
	20	20	125	39	60	20	26	5	
	25	25	150	39	57	25	28	—	
	25	25	150	39	57	25	28	—	
	32	25	170	39	57	32	28	—	
	32	25	170	39	57	32	28	—	
	32	32	170	39	57	32	35	—	
	32	32	170	39	57	32	35	—	
	20	20	136	50	71	20	26	5	
	20	20	136	50	71	20	26	5	
	25	25	161	50	68	25	28	—	
	25	25	161	50	68	25	28	—	
	32	25	181	50	68	32	28	—	
	32	25	181	50	68	32	28	—	
	32	32	181	50	68	32	35	—	
	32	32	181	50	68	32	35	—	

**WSP-Auswahl**

Sitzgröße	<b>Spannbrecher Bezeichnung</b>			
H	GY <span style="border: 1px solid black; border-radius: 50%; padding: 2px;">0475/0500/0524H</span> <small>Spannbrecher nachstehend abgebildet</small>			

Spannbrecher zum Einstechen/Abstechen > F012, F013					
Sitzgröße	Spannbrecher CW	GU	GS	GM	GFGS
		<small>(Für langspannte Stähle)</small>	<small>(Kleine Vorschübe)</small>	<small>(Mittlere Vorschübe)</small>	<small>(Cehärteter Stahl)</small>
H	4.75mm	●	●	●	●
	5.00mm	●	●	●	●

Multifunktionspannbrecher > F014, F015					
Sitzgröße	Spannbrecher CW	MF	MS	MM	BM
		<small>(Schichten)</small>	<small>(Kleine Vorschübe)</small>	<small>(Mittlere Vorschübe)</small>	<small>(Kopierdrehen)</small>
H	4.75mm				●
	RE 0.2	●			
	RE 0.4	●			
	RE 0.8	●			
	5.00mm				●
	RE 0.2	●			
	RE 0.4	●	●	●	
	RE 0.8	●	●	●	
	5.24mm	●			

● : Standard-WSP mit Abmessungen

**EINSTECHEN / ABSTECHEN**



## GY SERIE (AXIALEINSTECHEN)

### 4

### 00° Ausführung

WSP	GY2M <sup>GS</sup>	WSP	GY2G <sup>MF</sup>
WSP	GY2M <sup>GU</sup>	WSP	GY2M <sup>MS</sup>
WSP	GY1 <sup>GM</sup>	WSP	GY2M <sup>MM</sup>

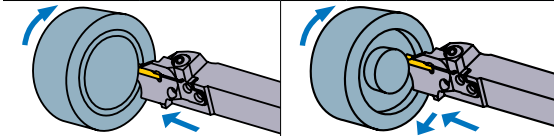

WSP GY2M<sup>BM</sup>

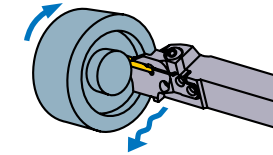

Hinweis 1) Modulare Schwerter und modulare Halter bitte separat bestellen.  
Hinweis 2) Spitze Modul in Rechtsausführung für den Halter in Rechtsausführung und Modul in Linksausführung für den Halter in Linksausführung verwenden.



Abb. zeigt Rechtsausführung.

Sitzgröße	Abmessungen (mm)				Typ	Ausführung (R/L)	Bestellbezeichnung				Bild
	CW	DAXN	DAXX	CDX			Halter	Lager	Modulares Schwert	Lager	
H	4.75 5.00 5.24	85	125	14	Modular	R	GYHR2020K00-M25R	●	GYM25RD-H14-085	●	3
					Modular	L	GYHL2020K00-M25L	●	GYM25LD-H14-085	●	3
					Modular	R	GYHR2525M00-M25R	●	GYM25RD-H14-085	●	1
					Modular	L	GYHL2525M00-M25L	●	GYM25LD-H14-085	●	1
				Modular	R	GYHR3225P00-M25R	●	GYM25RD-H14-085	●	5	
				Modular	L	GYHL3225P00-M25L	●	GYM25LD-H14-085	●	5	
				Modular	R	GYHR3232P00-M25R	●	GYM25RD-H14-085	●	5	
				Modular	L	GYHL3232P00-M25L	●	GYM25LD-H14-085	●	5	
				25 *2	Modular	R	GYHR2020K00-M25R	●	GYM25RD-H25-085	●	4
					Modular	L	GYHL2020K00-M25L	●	GYM25LD-H25-085	●	4
	Modular	R	GYHR2525M00-M25R		●	GYM25RD-H25-085	●	2			
	Modular	L	GYHL2525M00-M25L		●	GYM25LD-H25-085	●	2			
	Modular	R	GYHR3225P00-M25R		●	GYM25RD-H25-085	●	6			
	Modular	L	GYHL3225P00-M25L		●	GYM25LD-H25-085	●	6			
	125	200	14	Modular	R	GYHR2020K00-M25R	●	GYM25RD-H14-125	●	3	
				Modular	L	GYHL2020K00-M25L	●	GYM25LD-H14-125	●	3	
				Modular	R	GYHR2525M00-M25R	●	GYM25RD-H14-125	●	1	
				Modular	L	GYHL2525M00-M25L	●	GYM25LD-H14-125	●	1	
			Modular	R	GYHR3225P00-M25R	●	GYM25RD-H14-125	●	5		
			Modular	L	GYHL3225P00-M25L	●	GYM25LD-H14-125	●	5		
Modular			R	GYHR3232P00-M25R	●	GYM25RD-H14-125	●	5			
Modular			L	GYHL3232P00-M25L	●	GYM25LD-H14-125	●	5			
25 *2			Modular	R	GYHR2020K00-M25R	●	GYM25RD-H25-125	●	4		
			Modular	L	GYHL2020K00-M25L	●	GYM25LD-H25-125	●	4		
	Modular	R	GYHR2525M00-M25R	●	GYM25RD-H25-125	●	2				
	Modular	L	GYHL2525M00-M25L	●	GYM25LD-H25-125	●	2				
	Modular	R	GYHR3225P00-M25R	●	GYM25RD-H25-125	●	6				
	Modular	L	GYHL3225P00-M25L	●	GYM25LD-H25-125	●	6				
Modular	R	GYHR3232P00-M25R	●	GYM25RD-H25-125	●	6					
Modular	L	GYHL3232P00-M25L	●	GYM25LD-H25-125	●	6					

\*1 Die dargestellten Abmessungen gelten bei der Verwendung von Standard-WSP. Wenn andere WSP-Geometrien verwendet werden, können die Werte für LF, LH, LH2, und WF variieren.

\*2 Die maximale Einstechtiefe (CDX) hängt von der verwendeten Schneidplatte ab. Zur maximalen Einstechtiefe (CDX) bei verschiedenen Schneidplatten siehe Seite F012–F015.

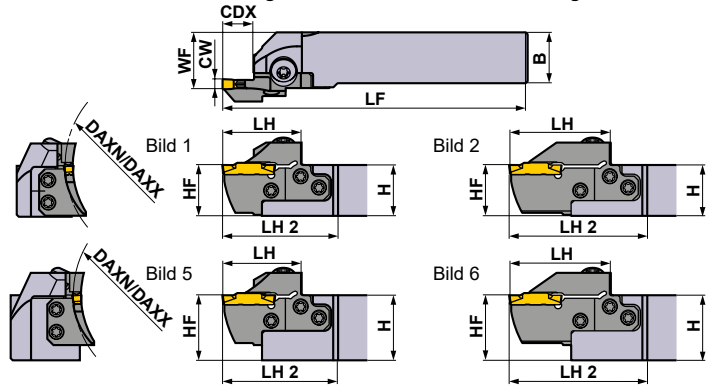
● : Lagerstandard.

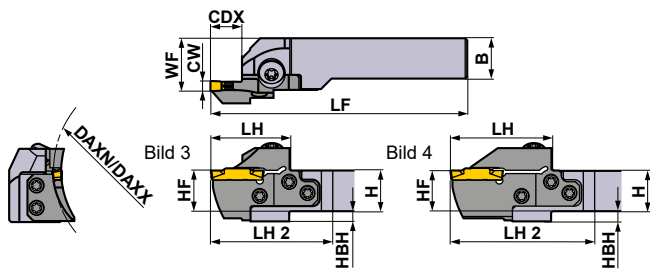

\* Schlüssel : ① : Spannschraube, ② : Schraube für Schwert

ERSATZTEILE			
Halter		5 St.	
	Spannschraube	Schraube für Schwert	Schlüssel*
GYHR/L2020K00-M25R/L	GY06013M (Spannmoment : 6.0N·m)	TS55 (Spannmoment : 5.0N·m)	①TKY30R ②TKY25D
GYHR/L2525M00-M25R/L			
GYHR/L3225P00-M25R/L			
GYHR/L3232P00-M25R/L			

Abb. zeigt Rechtsausführung.

	Abmessungen (mm) *1								Schnittmodus
	H	B	LF	LH	LH 2	HF	WF	HBH	
	20	20	125	39	60	20	26	5	R
	20	20	125	39	60	20	26	5	
	25	25	150	39	57	25	28	—	
	25	25	150	39	57	25	28	—	
	32	25	170	39	57	32	28	—	
	32	25	170	39	57	32	28	—	
	32	32	170	39	57	32	35	—	
	32	32	170	39	57	32	35	—	
	20	20	136	50	71	20	26	5	
	20	20	136	50	71	20	26	5	
	25	25	161	50	68	25	28	—	
	25	25	161	50	68	25	28	—	
	32	25	181	50	68	32	28	—	
	32	25	181	50	68	32	28	—	
	32	32	181	50	68	32	35	—	
	32	32	181	50	68	32	35	—	
	20	20	125	39	60	20	26	5	L
	20	20	125	39	60	20	26	5	
	25	25	150	39	57	25	28	—	
	25	25	150	39	57	25	28	—	
	32	25	170	39	57	32	28	—	
	32	25	170	39	57	32	28	—	
	32	32	170	39	57	32	35	—	
	32	32	170	39	57	32	35	—	
	20	20	136	50	71	20	26	5	
	20	20	136	50	71	20	26	5	
	25	25	161	50	68	25	28	—	
	25	25	161	50	68	25	28	—	
	32	25	181	50	68	32	28	—	
	32	25	181	50	68	32	28	—	
	32	32	181	50	68	32	35	—	
	32	32	181	50	68	32	35	—	

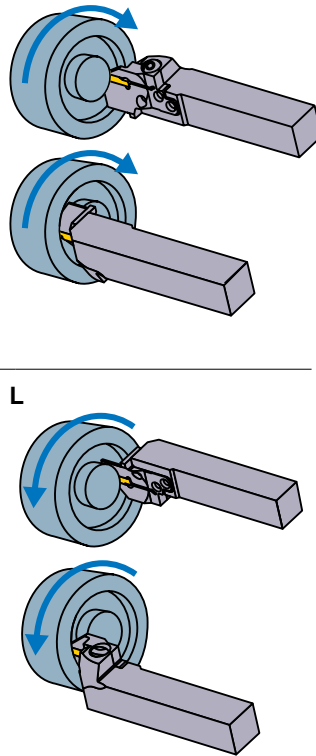

### WSP-Auswahl

Sitzgröße	<b>Spannbrecher Bezeichnung</b>
H	GY <span style="border: 1px dashed black; border-radius: 50%; padding: 2px;">0475/0500/0524H</span> <small>Spannbrecher nachstehend abgebildet</small>

Spannbrecher zum Einstechen/Abstechen > F012, F013					
Sitzgröße	Spannbrecher	GU	GS	GM	GFGS
	<small>(Für langspannte Stähle)</small>	<small>(Kleine Vorschübe)</small>	<small>(Mittlere Vorschübe)</small>	<small>(Gehärteter Stahl)</small>	
H	4.75mm	●	●	●	●
	5.00mm	●	●	●	●

Multifunktionsspannbrecher > F014, F015						
Sitzgröße	Spannbrecher	MF	MS	MM	BM	
		<small>(Schichten)</small>	<small>(Kleine Vorschübe)</small>	<small>(Mittlere Vorschübe)</small>	<small>(Kopierdrehen)</small>	
H	4.75mm	RE 0.2	●		●	
		RE 0.4	●			
		RE 0.8	●			
	5.00mm	RE 0.2	●			●
		RE 0.4	●	●	●	
		RE 0.8	●	●	●	
		5.24mm	●			

● : Standard-WSP mit Abmessungen



EINSTECHEN / ABSTECHE

IDENTIFIKATION > F008, F009  
 SCHNITTBEDINGUNGEN > F104  
 SICHERHEITSHINWEISE > F106

## GY SERIE (AXIALEINSTECHEN)

### 4

### 00° Ausführung

WSP	GY2M <sup>GS</sup>	WSP	GY2G <sup>MF</sup>
WSP	GY2M <sup>GU</sup>	WSP	GY2M <sup>MS</sup>
WSP	GY1 <sup>GM</sup> <sub>GFGS</sub>	WSP	GY2M <sup>MM</sup>

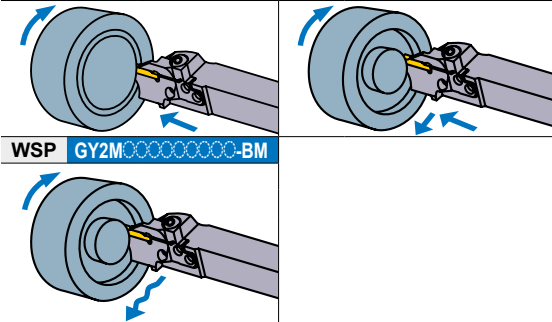

Hinweis 1) Modulare Schwerter und modulare Halter bitte separat bestellen.  
Hinweis 2) Spitze Modul in Rechtsausführung für den Halter in Rechtsausführung und Modul in Linksausführung für den Halter in Linksausführung verwenden.



Abb. zeigt Rechtsausführung.

Sitzgröße	Abmessungen (mm)				Typ	Ausführung (R/L)	Bestellbezeichnung				Bild
	CW	DAXN	DAXX	CDX			Halter	Lager	Modulares Schwert	Lager	
H	4.75 5.00 5.24	180	280	14	Modular	R	GYHR2020K00-M25R	●	GYM25RD-H14-180	●	3
					Modular	L	GYHL2020K00-M25L	●	GYM25LD-H14-180	●	3
					Modular	R	GYHR2525M00-M25R	●	GYM25RD-H14-180	●	1
					Modular	L	GYHL2525M00-M25L	●	GYM25LD-H14-180	●	1
					Modular	R	GYHR3225P00-M25R	●	GYM25RD-H14-180	●	5
					Modular	L	GYHL3225P00-M25L	●	GYM25LD-H14-180	●	5
					Modular	R	GYHR3232P00-M25R	●	GYM25RD-H14-180	●	5
					Modular	L	GYHL3232P00-M25L	●	GYM25LD-H14-180	●	5
	25 *2	Modular	R	GYHR2020K00-M25R	●	GYM25RD-H25-180	●	4			
		Modular	L	GYHL2020K00-M25L	●	GYM25LD-H25-180	●	4			
		Modular	R	GYHR2525M00-M25R	●	GYM25RD-H25-180	●	2			
		Modular	L	GYHL2525M00-M25L	●	GYM25LD-H25-180	●	2			
		Modular	R	GYHR3225P00-M25R	●	GYM25RD-H25-180	●	6			
		Modular	L	GYHL3225P00-M25L	●	GYM25LD-H25-180	●	6			
		Modular	R	GYHR3232P00-M25R	●	GYM25RD-H25-180	●	6			
		Modular	L	GYHL3232P00-M25L	●	GYM25LD-H25-180	●	6			
	250	999	14	Modular	R	GYHR2020K00-M25R	●	GYM25RD-H14-250	●	3	
				Modular	L	GYHL2020K00-M25L	●	GYM25LD-H14-250	●	3	
				Modular	R	GYHR2525M00-M25R	●	GYM25RD-H14-250	●	1	
				Modular	L	GYHL2525M00-M25L	●	GYM25LD-H14-250	●	1	
25 *2			Modular	R	GYHR3225P00-M25R	●	GYM25RD-H14-250	●	5		
			Modular	L	GYHL3225P00-M25L	●	GYM25LD-H14-250	●	5		
			Modular	R	GYHR3232P00-M25R	●	GYM25RD-H14-250	●	5		
			Modular	L	GYHL3232P00-M25L	●	GYM25LD-H14-250	●	5		
25 *2	Modular	R	GYHR2020K00-M25R	●	GYM25RD-H25-250	●	4				
	Modular	L	GYHL2020K00-M25L	●	GYM25LD-H25-250	●	4				
	Modular	R	GYHR2525M00-M25R	●	GYM25RD-H25-250	●	2				
	Modular	L	GYHL2525M00-M25L	●	GYM25LD-H25-250	●	2				
25 *2	Modular	R	GYHR3225P00-M25R	●	GYM25RD-H25-250	●	6				
	Modular	L	GYHL3225P00-M25L	●	GYM25LD-H25-250	●	6				
	Modular	R	GYHR3232P00-M25R	●	GYM25RD-H25-250	●	6				
	Modular	L	GYHL3232P00-M25L	●	GYM25LD-H25-250	●	6				

\*1 Die dargestellten Abmessungen gelten bei der Verwendung von Standard-WSP. Wenn andere WSP-Geometrien verwendet werden, können die Werte für LF, LH, LH2, und WF variieren.

\*2 Die maximale Einstechtiefe (CDX) hängt von der verwendeten Schneidplatte ab. Zur maximalen Einstechtiefe (CDX) bei verschiedenen Schneidplatten siehe Seite F012–F015.

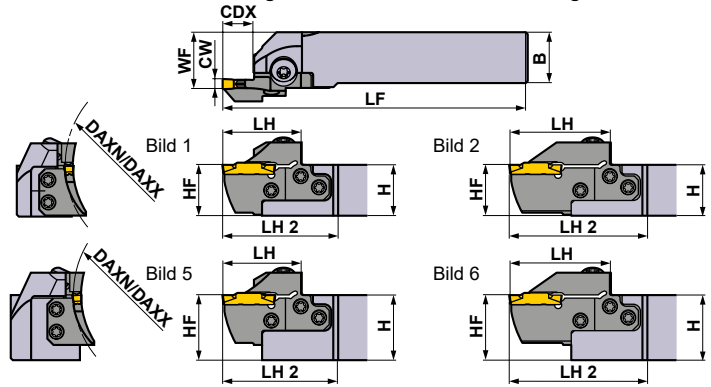
● : Lagerstandard.

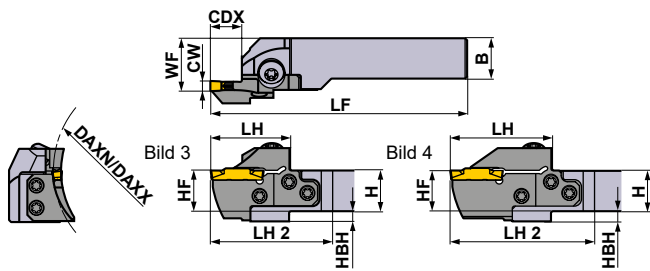

\* Schlüssel : ① : Spannschraube, ② : Schraube für Schwert

ERSATZTEILE			
Halter		5 St.	
	Spannschraube	Schraube für Schwert	Schlüssel*
GYHR/L2020K00-M25R/L	GY06013M (Spannmoment : 6.0N·m)	TS55 (Spannmoment : 5.0N·m)	①TKY30R ②TKY25D
GYHR/L2525M00-M25R/L			
GYHR/L3225P00-M25R/L			
GYHR/L3232P00-M25R/L			

Abb. zeigt Rechtsausführung.

	Abmessungen (mm) *1								Schnittmodus
	H	B	LF	LH	LH 2	HF	WF	HBH	
	20	20	125	39	60	20	26	5	R
	20	20	125	39	60	20	26	5	
	25	25	150	39	57	25	28	—	
	25	25	150	39	57	25	28	—	
	32	25	170	39	57	32	28	—	
	32	25	170	39	57	32	28	—	
	32	32	170	39	57	32	35	—	
	32	32	170	39	57	32	35	—	
	20	20	136	50	71	20	26	5	
	20	20	136	50	71	20	26	5	
	25	25	161	50	68	25	28	—	
	25	25	161	50	68	25	28	—	
	32	25	181	50	68	32	28	—	
	32	25	181	50	68	32	28	—	
	32	32	181	50	68	32	35	—	
	32	32	181	50	68	32	35	—	
	20	20	125	39	60	20	26	5	L
	20	20	125	39	60	20	26	5	
	25	25	150	39	57	25	28	—	
	25	25	150	39	57	25	28	—	
	32	25	170	39	57	32	28	—	
	32	25	170	39	57	32	28	—	
	32	32	170	39	57	32	35	—	
	32	32	170	39	57	32	35	—	
	20	20	136	50	71	20	26	5	
	20	20	136	50	71	20	26	5	
	25	25	161	50	68	25	28	—	
	25	25	161	50	68	25	28	—	
	32	25	181	50	68	32	28	—	
	32	25	181	50	68	32	28	—	
	32	32	181	50	68	32	35	—	
	32	32	181	50	68	32	35	—	

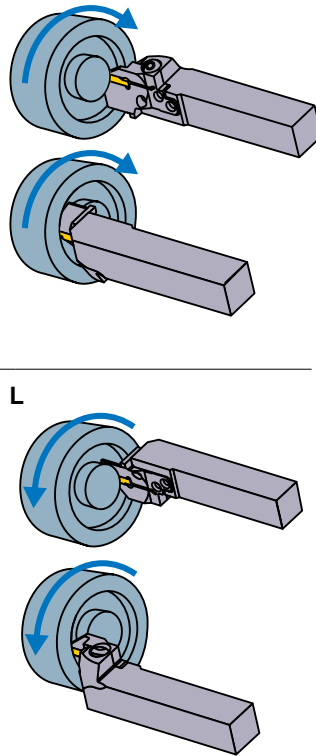

WSP-Auswahl

Sitzgröße	<b>Spannbrecher Bezeichnung</b>
H	GY <span style="border: 1px solid black; border-radius: 50%; padding: 2px;">0475/0500/0524H</span> <small>Spannbrecher nachstehend abgebildet</small>

Spannbrecher zum Einstechen/Abstechen > F012, F013					
Sitzgröße	Spannbrecher	GU	GS	GM	GFGS
		<small>(Für langspannte Stähle)</small>	<small>(Kleine Vorschübe)</small>	<small>(Mittlere Vorschübe)</small>	<small>(Cehärteter Stahl)</small>
H	4.75mm	●	●	●	●
	5.00mm	●	●	●	●

Multifunktionsspannbrecher > F014, F015						
Sitzgröße	Spannbrecher	MF	MS	MM	BM	
		<small>(Schichten)</small>	<small>(Kleine Vorschübe)</small>	<small>(Mittlere Vorschübe)</small>	<small>(Kopierdrehen)</small>	
H	4.75mm	RE 0.2	●		●	
		RE 0.4	●			
		RE 0.8	●			
	5.00mm	RE 0.2	●			●
		RE 0.4	●	●	●	
		RE 0.8	●	●	●	
		5.24mm	●			

● : Standard-WSP mit Abmessungen

EINSTECHEN / ABSTECHE

# GY SERIE (AXIALEINSTECHEN)

**4** 00° Ausführung

WSP	GY2M <sup>GS</sup>	WSP	GY2G <sup>MF</sup>
WSP	GY2M <sup>GU</sup>	WSP	GY2M <sup>MS</sup>
WSP	GY1G <sup>GFGS</sup>	WSP	GY2M <sup>MM</sup>

WSP GY2M<sup>BM</sup>

Hinweis 1) Modulare Schwerter und modulare Halter bitte separat bestellen.  
 Hinweis 2) Spitze Modul in Rechtsausführung für den Halter in Rechtsausführung und Modul in Linksausführung für den Halter in Linksausführung verwenden.



Abb. zeigt Rechtsausführung.

Sitzgröße	Abmessungen (mm)				Typ	Ausführung (R/L)	Bestellbezeichnung				Bild
	CW	DAXN	DAXX	CDX			Halter	Lager	Modulares Schwert	Lager	
J	6.00 6.31 6.35	50	70	14	Modular	R	GYHR2020K00-M25R	●	GYM25RD-J14-050	●	3
					Modular	L	GYHL2020K00-M25L	●	GYM25LD-J14-050	●	3
					Modular	R	GYHR2525M00-M25R	●	GYM25RD-J14-050	●	1
					Modular	L	GYHL2525M00-M25L	●	GYM25LD-J14-050	●	1
		Modular	R	GYHR3225P00-M25R	●	GYM25RD-J14-050	●	5			
		Modular	L	GYHL3225P00-M25L	●	GYM25LD-J14-050	●	5			
		Modular	R	GYHR3232P00-M25R	●	GYM25RD-J14-050	●	5			
		Modular	L	GYHL3232P00-M25L	●	GYM25LD-J14-050	●	5			
		Modular	R	GYHR2020K00-M25R	●	GYM25RD-J14-070	●	3			
		Modular	L	GYHL2020K00-M25L	●	GYM25LD-J14-070	●	3			
		Modular	R	GYHR2525M00-M25R	●	GYM25RD-J14-070	●	1			
		Modular	L	GYHL2525M00-M25L	●	GYM25LD-J14-070	●	1			
	Modular	R	GYHR3225P00-M25R	●	GYM25RD-J14-070	●	5				
	Modular	L	GYHL3225P00-M25L	●	GYM25LD-J14-070	●	5				
	Modular	R	GYHR3232P00-M25R	●	GYM25RD-J14-070	●	5				
	Modular	L	GYHL3232P00-M25L	●	GYM25LD-J14-070	●	5				
	Modular	R	GYHR2020K00-M25R	●	GYM25RD-J25-070	●	4				
	Modular	L	GYHL2020K00-M25L	●	GYM25LD-J25-070	●	4				
	Modular	R	GYHR2525M00-M25R	●	GYM25RD-J25-070	●	2				
	Modular	L	GYHL2525M00-M25L	●	GYM25LD-J25-070	●	2				
	Modular	R	GYHR3225P00-M25R	●	GYM25RD-J25-070	●	6				
	Modular	L	GYHL3225P00-M25L	●	GYM25LD-J25-070	●	6				
	Modular	R	GYHR3232P00-M25R	●	GYM25RD-J25-070	●	6				
	Modular	L	GYHL3232P00-M25L	●	GYM25LD-J25-070	●	6				
Modular	R	GYHR2020K00-M25R	●	GYM25RD-J14-110	●	3					
Modular	L	GYHL2020K00-M25L	●	GYM25LD-J14-110	●	3					
Modular	R	GYHR2525M00-M25R	●	GYM25RD-J14-110	●	1					
Modular	L	GYHL2525M00-M25L	●	GYM25LD-J14-110	●	1					
Modular	R	GYHR3225P00-M25R	●	GYM25RD-J14-110	●	5					
Modular	L	GYHL3225P00-M25L	●	GYM25LD-J14-110	●	5					
Modular	R	GYHR3232P00-M25R	●	GYM25RD-J14-110	●	5					
Modular	L	GYHL3232P00-M25L	●	GYM25LD-J14-110	●	5					
Modular	R	GYHR2020K00-M25R	●	GYM25RD-J25-110	●	4					
Modular	L	GYHL2020K00-M25L	●	GYM25LD-J25-110	●	4					
Modular	R	GYHR2525M00-M25R	●	GYM25RD-J25-110	●	2					
Modular	L	GYHL2525M00-M25L	●	GYM25LD-J25-110	●	2					
Modular	R	GYHR3225P00-M25R	●	GYM25RD-J25-110	●	6					
Modular	L	GYHL3225P00-M25L	●	GYM25LD-J25-110	●	6					
Modular	R	GYHR3232P00-M25R	●	GYM25RD-J25-110	●	6					
Modular	L	GYHL3232P00-M25L	●	GYM25LD-J25-110	●	6					

\*1 Die dargestellten Abmessungen gelten bei der Verwendung von Standard-WSP. Wenn andere WSP-Geometrien verwendet werden, können die Werte für LF, LH, LH2, und WF variieren.

\*2 Die maximale Einstechtiefe (CDX) hängt von der verwendeten Schneidplatte ab. Zur maximalen Einstechtiefe (CDX) bei verschiedenen Schneidplatten siehe Seite F012–F015.

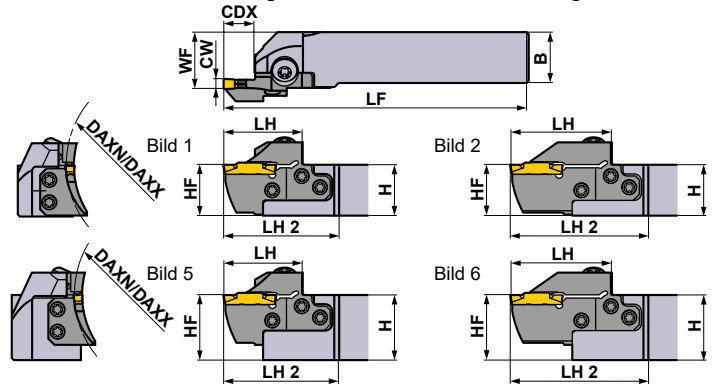
● : Lagerstandard.

EINSTECHEN / ABSTECHEN

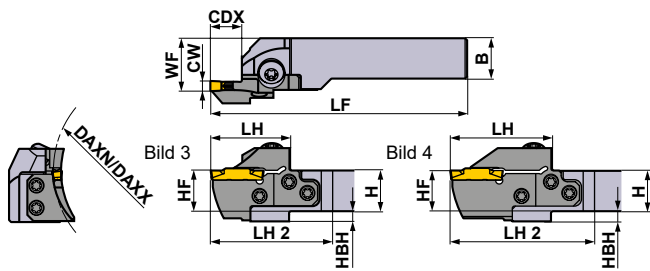

\* Schlüssel : ① : Spannschraube, ② : Schraube für Schwert

ERSATZTEILE			
Halter			
	Spannschraube	Schraube für Schwert	Schlüssel*
GYHR/L2020K00-M25R/L	GY06013M (Spannmoment : 6.0N·m)	TS55 (Spannmoment : 5.0N·m)	①TKY30R ②TKY25D
GYHR/L2525M00-M25R/L			
GYHR/L3225P00-M25R/L			
GYHR/L3232P00-M25R/L			

Abb. zeigt Rechtsausführung.

	Abmessungen (mm) *1								Schnittmodus
	H	B	LF	LH	LH 2	HF	WF	HBH	
	20	20	125	39	60	20	26	5	R
	20	20	125	39	60	20	26	5	
	25	25	150	39	57	25	28	—	
	25	25	150	39	57	25	28	—	
	32	25	170	39	57	32	28	—	
	32	25	170	39	57	32	28	—	
	32	32	170	39	57	32	35	—	
	32	32	170	39	57	32	35	—	
	20	20	125	39	60	20	26	5	
	20	20	125	39	60	20	26	5	
	25	25	150	39	57	25	28	—	
	25	25	150	39	57	25	28	—	
	32	25	170	39	57	32	28	—	
	32	25	170	39	57	32	28	—	
	32	32	170	39	57	32	35	—	
	32	32	170	39	57	32	35	—	
	20	20	136	50	71	20	26	5	
	20	20	136	50	71	20	26	5	
	25	25	161	50	68	25	28	—	
	25	25	161	50	68	25	28	—	
	32	25	181	50	68	32	28	—	
	32	25	181	50	68	32	28	—	
	32	32	181	50	68	32	35	—	
	32	32	181	50	68	32	35	—	
	20	20	125	39	60	20	26	5	
	20	20	125	39	60	20	26	5	
	25	25	150	39	57	25	28	—	
	25	25	150	39	57	25	28	—	
	32	25	170	39	57	32	28	—	
	32	25	170	39	57	32	28	—	
	32	32	170	39	57	32	35	—	
	32	32	170	39	57	32	35	—	
	20	20	136	50	71	20	26	5	
	20	20	136	50	71	20	26	5	
	25	25	161	50	68	25	28	—	
	25	25	161	50	68	25	28	—	
	32	25	181	50	68	32	28	—	
	32	25	181	50	68	32	28	—	
	32	32	181	50	68	32	35	—	
	32	32	181	50	68	32	35	—	

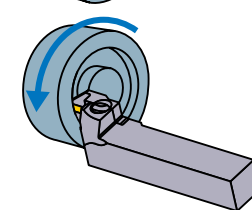
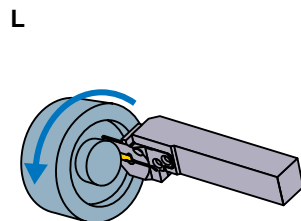
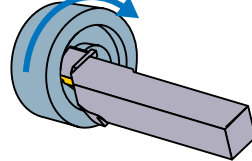
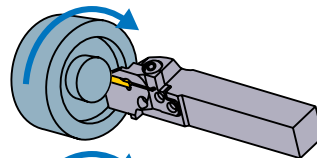

### WSP-Auswahl

Sitzgröße	Spannbrecher Bezeichnung
J	GY0600/0631/0635J — Spannbrecher nachstehend abgebildet

Spannbrecher zum Einstechen/Abstechen > F012, F013					
Sitzgröße	Spannbrecher CW	GU	GS	GM	GFGS
		(Für langspannte Stähle)	(Kleine Vorschübe)	(Mittlere Vorschübe)	(Cehärteter Stahl)
J	6.00mm	●	●	●	●
	6.35mm	●	●	●	●

Multifunktionsspannbrecher > F014, F015					
Sitzgröße	Spannbrecher CW	MF	MS	MM	BM
		(Schichten)	(Kleine Vorschübe)	(Mittlere Vorschübe)	(Kopierdrehen)
J	6.00mm				●
	RE 0.2	●			
	RE 0.4	●	●	●	
	RE 0.8	●	●	●	
	6.31mm	●			
	6.35mm				●
	RE 0.2	●			
	RE 0.4	●			
RE 0.8	●				

● : Standard-WSP mit Abmessungen



## GY SERIE (AXIALEINSTECHEN)

### 4

### 00° Ausführung

WSP	GY2M <sup>GS</sup>	WSP	GY2G <sup>MF</sup>
WSP	GY2M <sup>GU</sup>	WSP	GY2M <sup>MS</sup>
WSP	GY1G <sup>GFGS</sup>	WSP	GY2M <sup>MM</sup>

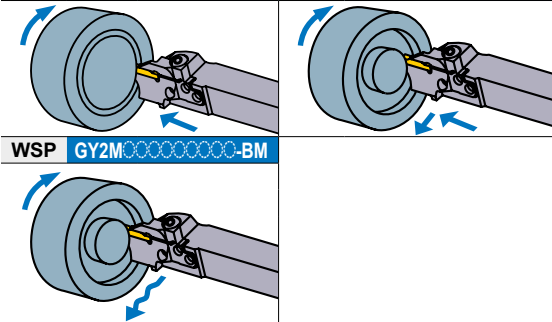

Hinweis 1) Modulare Schwerter und modulare Halter bitte separat bestellen.  
Hinweis 2) Spitze Modul in Rechtsausführung für den Halter in Rechtsausführung und Modul in Linksausführung für den Halter in Linksausführung verwenden.



Abb. zeigt Rechtsausführung.

Sitzgröße	Abmessungen (mm)				Typ	Ausführung (R/L)	Bestellbezeichnung				Bild
	CW	DAXN	DAXX	CDX			Halter	Lager	Modulares Schwert	Lager	
J	6.00 6.31 6.35	170	280	14	Modular	R	GYHR2020K00-M25R	●	GYM25RD-J14-170	●	3
					Modular	L	GYHL2020K00-M25L	●	GYM25LD-J14-170	●	3
					Modular	R	GYHR2525M00-M25R	●	GYM25RD-J14-170	●	1
					Modular	L	GYHL2525M00-M25L	●	GYM25LD-J14-170	●	1
					Modular	R	GYHR3225P00-M25R	●	GYM25RD-J14-170	●	5
					Modular	L	GYHL3225P00-M25L	●	GYM25LD-J14-170	●	5
		25 *2	Modular	R	GYHR2020K00-M25R	●	GYM25RD-J25-170	●	4		
			Modular	L	GYHL2020K00-M25L	●	GYM25LD-J25-170	●	4		
			Modular	R	GYHR2525M00-M25R	●	GYM25RD-J25-170	●	2		
			Modular	L	GYHL2525M00-M25L	●	GYM25LD-J25-170	●	2		
			Modular	R	GYHR3225P00-M25R	●	GYM25RD-J25-170	●	6		
			Modular	L	GYHL3225P00-M25L	●	GYM25LD-J25-170	●	6		
	250	999	14	Modular	R	GYHR2020K00-M25R	●	GYM25RD-J14-250	●	3	
				Modular	L	GYHL2020K00-M25L	●	GYM25LD-J14-250	●	3	
				Modular	R	GYHR2525M00-M25R	●	GYM25RD-J14-250	●	1	
				Modular	L	GYHL2525M00-M25L	●	GYM25LD-J14-250	●	1	
				Modular	R	GYHR3225P00-M25R	●	GYM25RD-J14-250	●	5	
				Modular	L	GYHL3225P00-M25L	●	GYM25LD-J14-250	●	5	
		25 *2	Modular	R	GYHR2020K00-M25R	●	GYM25RD-J25-250	●	4		
			Modular	L	GYHL2020K00-M25L	●	GYM25LD-J25-250	●	4		
			Modular	R	GYHR2525M00-M25R	●	GYM25RD-J25-250	●	2		
			Modular	L	GYHL2525M00-M25L	●	GYM25LD-J25-250	●	2		
			Modular	R	GYHR3225P00-M25R	●	GYM25RD-J25-250	●	6		
			Modular	L	GYHL3225P00-M25L	●	GYM25LD-J25-250	●	6		

\*1 Die dargestellten Abmessungen gelten bei der Verwendung von Standard-WSP. Wenn andere WSP-Geometrien verwendet werden, können die Werte für LF, LH, LH2, und WF variieren.

\*2 Die maximale Einstechtiefe (CDX) hängt von der verwendeten Schneidplatte ab. Zur maximalen Einstechtiefe (CDX) bei verschiedenen Schneidplatten siehe Seite F012–F015.

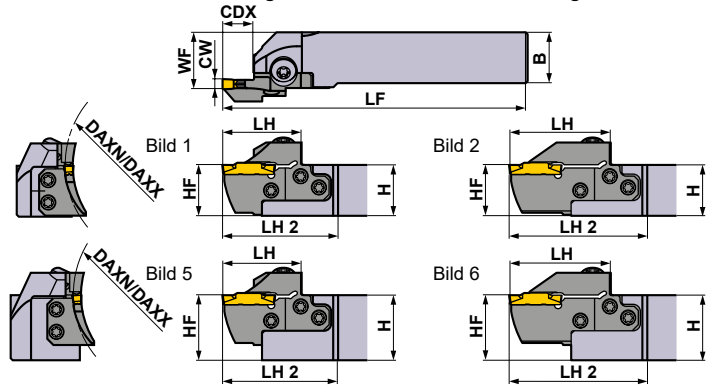
● : Lagerstandard.



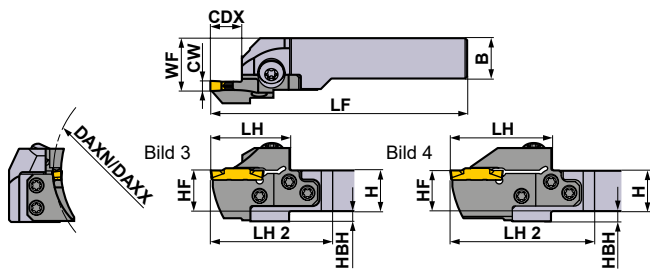

\* Schlüssel : ① : Spannschraube, ② : Schraube für Schwert

ERSATZTEILE			
Halter			
	Spannschraube	Schraube für Schwert 5 St.	Schlüssel*
GYHR/L2020K00-M25R/L	GY06013M (Spannmoment : 6.0N·m)	TS55 (Spannmoment : 5.0N·m)	①TKY30R ②TKY25D
GYHR/L2525M00-M25R/L			
GYHR/L3225P00-M25R/L			
GYHR/L3232P00-M25R/L			

Abb. zeigt Rechtsausführung.

	Abmessungen (mm) *1								Schnittmodus
	H	B	LF	LH	LH 2	HF	WF	HBH	
	20	20	125	39	60	20	26	5	<b>R</b> 
	20	20	125	39	60	20	26	5	
	25	25	150	39	57	25	28	—	
	25	25	150	39	57	25	28	—	
	32	25	170	39	57	32	28	—	
	32	25	170	39	57	32	28	—	
	32	32	170	39	57	32	35	—	
	32	32	170	39	57	32	35	—	
	20	20	136	50	71	20	26	5	
	20	20	136	50	71	20	26	5	
	25	25	161	50	68	25	28	—	
	25	25	161	50	68	25	28	—	
	32	25	181	50	68	32	28	—	
	32	25	181	50	68	32	28	—	
	32	32	181	50	68	32	35	—	
	32	32	181	50	68	32	35	—	
	20	20	125	39	60	20	26	5	<b>L</b> 
	20	20	125	39	60	20	26	5	
	25	25	150	39	57	25	28	—	
	25	25	150	39	57	25	28	—	
	32	25	170	39	57	32	28	—	
	32	25	170	39	57	32	28	—	
	32	32	170	39	57	32	35	—	
	32	32	170	39	57	32	35	—	
	20	20	136	50	71	20	26	5	
	20	20	136	50	71	20	26	5	
	25	25	161	50	68	25	28	—	
	25	25	161	50	68	25	28	—	
	32	25	181	50	68	32	28	—	
	32	25	181	50	68	32	28	—	
	32	32	181	50	68	32	35	—	
	32	32	181	50	68	32	35	—	

**WSP-Auswahl**

Sitzgröße	<b>Spannbrecher Bezeichnung</b>
J	GY <span style="border: 1px solid black; border-radius: 50%; padding: 2px;">0600/0631/0635</span> J <span style="border: 1px solid black; border-radius: 50%; padding: 2px;">0000</span> — Spannbrecher nachstehend abgebildet

Spannbrecher zum Einstechen/Abstechen > F012, F013					
Sitzgröße	Spannbrecher	GU	GS	GM	GFGS
		(Für langspannte Stähle)	(Kleine Vorschübe)	(Mittlere Vorschübe)	(Cehärteter Stahl)
J	6.00mm	●	●	●	●
	6.35mm	●	●	●	●

Multifunktionsspannbrecher > F014, F015					
Sitzgröße	Spannbrecher	MF	MS	MM	BM
		(Schichten)	(Kleine Vorschübe)	(Mittlere Vorschübe)	(Kopierdrehen)
J	6.00mm				●
	RE 0.2	●			
	RE 0.4	●	●	●	
	RE 0.8	●	●	●	
	6.31mm	●			
	6.35mm				●
	RE 0.2	●			
	RE 0.4	●			
	RE 0.8	●			

● : Standard-WSP mit Abmessungen

EINSTECHEN / ABSTECHE

# GY SERIE (AXIALEINSTECHEN)

5

90° Ausführung

Hinweis 1) Modulare Schwerter und modulare Halter bitte separat bestellen.  
Hinweis 2) Bitte Modul in Linksausführung für den Halter in Rechtsausführung und Modul in Rechtsausführung für den Halter in Linksausführung verwenden.

WSP	GY2M <sup>GS</sup> <sub>GM</sub>	WSP	GY2G <sup>GS</sup> <sub>GM</sub> -MF
WSP	GY2M <sup>GM</sup> <sub>GFGS</sub> -GU	WSP	GY2M <sup>GM</sup> <sub>GFGS</sub> -MS
WSP	GY1 <sup>M</sup> <sub>G</sub>	WSP	GY2M <sup>GM</sup> <sub>GFGS</sub> -MM



Abb. zeigt Rechtsausführung.

Sitzgröße	Abmessungen (mm)				Typ	Ausführung (R/L)	Bestellbezeichnung				Bild
	CW	DAXN	DAXX	CDX			Halter	Lager	Modulares Schwert	Lager	
D	2.00 2.24	40	50	12	Modular	R L	GYHR2525M90-M25L GYHL2525M90-M25R	● ●	GYM25LD-D12-040 GYM25RD-D12-040	● ●	1 1
		50	60	12	Modular	R L	GYHR2525M90-M25L GYHL2525M90-M25R	● ●	GYM25LD-D12-050 GYM25RD-D12-050	● ●	1 1
		60	75	12	Modular	R L	GYHR2525M90-M25L GYHL2525M90-M25R	● ●	GYM25LD-D12-060 GYM25RD-D12-060	● ●	1 1
		75	100	12	Modular	R L	GYHR2525M90-M25L GYHL2525M90-M25R	● ●	GYM25LD-D12-075 GYM25RD-D12-075	● ●	1 1
		100	150	12	Modular	R L	GYHR2525M90-M25L GYHL2525M90-M25R	● ●	GYM25LD-D12-100 GYM25RD-D12-100	● ●	1 1
		135	200	12	Modular	R L	GYHR2525M90-M25L GYHL2525M90-M25R	● ●	GYM25LD-D12-135 GYM25RD-D12-135	● ●	1 1
		180	250	12	Modular	R L	GYHR2525M90-M25L GYHL2525M90-M25R	● ●	GYM25LD-D12-180 GYM25RD-D12-180	● ●	1 1
E	2.39 2.50 2.74	40	50	12	Modular	R L	GYHR2525M90-M25L GYHL2525M90-M25R	● ●	GYM25LD-E12-040 GYM25RD-E12-040	● ●	1 1
		50	60	12	Modular	R L	GYHR2525M90-M25L GYHL2525M90-M25R	● ●	GYM25LD-E12-050 GYM25RD-E12-050	● ●	1 1
		60	75	12	Modular	R L	GYHR2525M90-M25L GYHL2525M90-M25R	● ●	GYM25LD-E12-060 GYM25RD-E12-060	● ●	1 1
		75	100	12	Modular	R L	GYHR2525M90-M25L GYHL2525M90-M25R	● ●	GYM25LD-E12-075 GYM25RD-E12-075	● ●	1 1
		100	150	12	Modular	R L	GYHR2525M90-M25L GYHL2525M90-M25R	● ●	GYM25LD-E12-100 GYM25RD-E12-100	● ●	1 1
		135	200	12	Modular	R L	GYHR2525M90-M25L GYHL2525M90-M25R	● ●	GYM25LD-E12-135 GYM25RD-E12-135	● ●	1 1
		180	250	12	Modular	R L	GYHR2525M90-M25L GYHL2525M90-M25R	● ●	GYM25LD-E12-180 GYM25RD-E12-180	● ●	1 1

\*1 Die dargestellten Abmessungen gelten bei der Verwendung von Standard-WSP. Wenn andere WSP-Geometrien verwendet werden, können die Werte für LF, LH und WF variieren.

● : Lagerstandard.

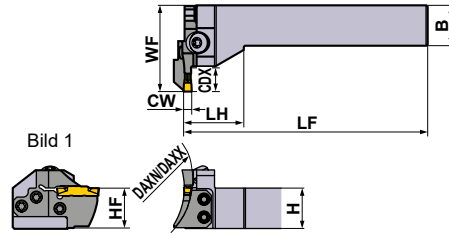
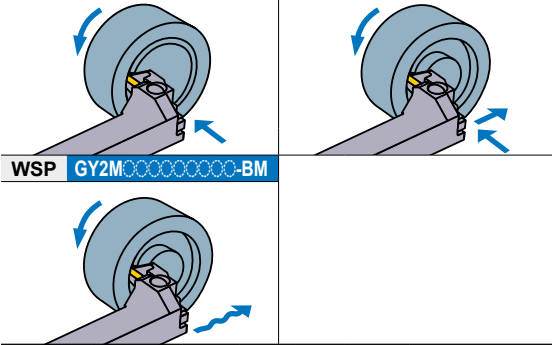

# GY SERIE (AXIALEINSTECHEN)

5

90° Ausführung

Hinweis 1) Modulare Schwerter und modulare Halter bitte separat bestellen.  
Hinweis 2) Spitze Modul in Linksausführung für den Halter in Rechtsausführung und Modul in Rechtsausführung für den Halter in Linksausführung verwenden.

WSP	GY2M <sup>GS</sup> <sub>GM</sub>	WSP	GY2G <sup>GS</sup> <sub>MF</sub>
WSP	GY2M <sup>GU</sup>	WSP	GY2M <sup>MS</sup>
WSP	GY1 <sup>GM</sup> <sub>GFGS</sub>	WSP	GY2M <sup>MM</sup>



Abb. zeigt Rechtsausführung.

Sitzgröße	Abmessungen (mm)			Typ	Ausführung (R/L)	Bestellbezeichnung				Bild	
	CW	DAXN	DAXX			CDX	Halter	Lager	Modulares Schwert		Lager
F	3.00 3.18 3.24	35	40	12	Modular	R	GYHR2525M90-M25L	●	GYM25LD-F12-035	●	1
				L	GYHL2525M90-M25R	●	GYM25RD-F12-035	●	1		
		40	50	12	Modular	R	GYHR2525M90-M25L	●	GYM25LD-F12-040	●	1
				L	GYHL2525M90-M25R	●	GYM25RD-F12-040	●	1		
		50	60	12	Modular	R	GYHR2525M90-M25L	●	GYM25LD-F12-050	●	1
				L	GYHL2525M90-M25R	●	GYM25RD-F12-050	●	1		
		60	75	12	Modular	R	GYHR2525M90-M25L	●	GYM25LD-F12-060	●	1
				L	GYHL2525M90-M25R	●	GYM25RD-F12-060	●	1		
				20 *2	Modular	R	GYHR2525M90-M25L	●	GYM25LD-F20-060	●	2
				L	GYHL2525M90-M25R	●	GYM25RD-F20-060	●	2		
		75	100	12	Modular	R	GYHR2525M90-M25L	●	GYM25LD-F12-075	●	1
				L	GYHL2525M90-M25R	●	GYM25RD-F12-075	●	1		
				20 *2	Modular	R	GYHR2525M90-M25L	●	GYM25LD-F20-075	●	2
				L	GYHL2525M90-M25R	●	GYM25RD-F20-075	●	2		
		100	150	12	Modular	R	GYHR2525M90-M25L	●	GYM25LD-F12-100	●	1
				L	GYHL2525M90-M25R	●	GYM25RD-F12-100	●	1		
				20 *2	Modular	R	GYHR2525M90-M25L	●	GYM25LD-F20-100	●	2
				L	GYHL2525M90-M25R	●	GYM25RD-F20-100	●	2		
		135	200	12	Modular	R	GYHR2525M90-M25L	●	GYM25LD-F12-135	●	1
				L	GYHL2525M90-M25R	●	GYM25RD-F12-135	●	1		
20 *2	Modular			R	GYHR2525M90-M25L	●	GYM25LD-F20-135	●	2		
L	GYHL2525M90-M25R			●	GYM25RD-F20-135	●	2				
180	250	12	Modular	R	GYHR2525M90-M25L	●	GYM25LD-F12-180	●	1		
		L	GYHL2525M90-M25R	●	GYM25RD-F12-180	●	1				
		20 *2	Modular	R	GYHR2525M90-M25L	●	GYM25LD-F20-180	●	2		
		L	GYHL2525M90-M25R	●	GYM25RD-F20-180	●	2				
225	999	12	Modular	R	GYHR2525M90-M25L	●	GYM25LD-F12-225	●	1		
		L	GYHL2525M90-M25R	●	GYM25RD-F12-225	●	1				
		20 *2	Modular	R	GYHR2525M90-M25L	●	GYM25LD-F20-225	●	2		
		L	GYHL2525M90-M25R	●	GYM25RD-F20-225	●	2				

\*1 Die dargestellten Abmessungen gelten bei der Verwendung von Standard-WSP. Wenn andere WSP-Geometrien verwendet werden, können die Werte für LF, LH und WF variieren.  
\*2 Die maximale Einstechtiefe (CDX) hängt von der verwendeten Schneidplatte ab. Zur maximalen Einstechtiefe (CDX) bei verschiedenen Schneidplatten siehe Seite F012–F015.

● : Lagerstandard.

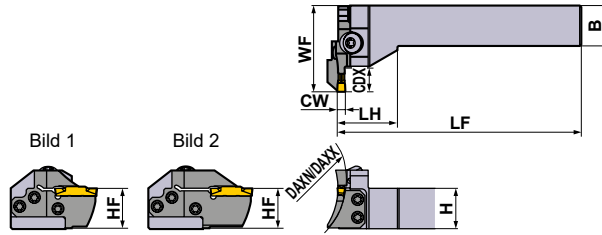
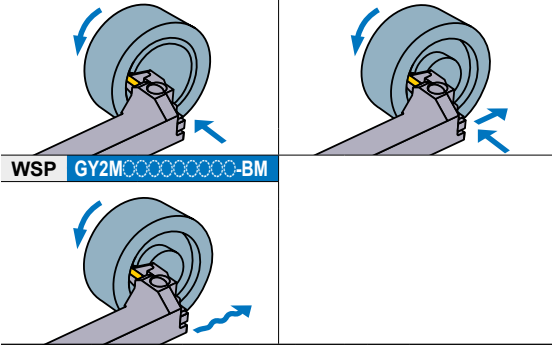
EINSTECHEN / ABSTECHEN



## GY SERIE (AXIALEINSTECHEN)

### 5

### 90° Ausführung

Hinweis 1) Modulare Schwerter und modulare Halter bitte separat bestellen.  
Hinweis 2) Bitte Modul in Linksausführung für den Halter in Rechtsausführung und Modul in Rechtsausführung für den Halter in Linksausführung verwenden.

WSP	GY2M <sup>GS</sup> <sub>GM</sub>	WSP	GY2G <sup>GS</sup> <sub>GM</sub> -MF
WSP	GY2M <sup>GM</sup> <sub>GFGS</sub> -GU	WSP	GY2M <sup>GM</sup> <sub>GFGS</sub> -MS
WSP	GY1 <sup>GM</sup> <sub>GFGS</sub>	WSP	GY2M <sup>GM</sup> <sub>GFGS</sub> -MM



Abb. zeigt Rechtsausführung.



Sitzgröße	Abmessungen (mm)				Typ	Ausführung (R/L)	Bestellbezeichnung				Bild
	CW	DAXN	DAXX	CDX			Halter	Lager	Modulares Schwert	Lager	
G	4.00 4.24	40	50	14	Modular	R	GYHR2525M90-M25L	●	GYM25LD-G14-040	●	1
				L	GYHL2525M90-M25R	●	GYM25RD-G14-040	●	1		
		50	60	14	Modular	R	GYHR2525M90-M25L	●	GYM25LD-G14-050	●	1
				L	GYHL2525M90-M25R	●	GYM25RD-G14-050	●	1		
		60	85	14	Modular	R	GYHR2525M90-M25L	●	GYM25LD-G14-060	●	1
				L	GYHL2525M90-M25R	●	GYM25RD-G14-060	●	1		
		25 *2		14	Modular	R	GYHR2525M90-M25L	●	GYM25LD-G25-060	●	2
				L	GYHL2525M90-M25R	●	GYM25RD-G25-060	●	2		
		85	125	14	Modular	R	GYHR2525M90-M25L	●	GYM25LD-G14-085	●	1
				L	GYHL2525M90-M25R	●	GYM25RD-G14-085	●	1		
		25 *2		14	Modular	R	GYHR2525M90-M25L	●	GYM25LD-G25-085	●	2
				L	GYHL2525M90-M25R	●	GYM25RD-G25-085	●	2		
		125	200	14	Modular	R	GYHR2525M90-M25L	●	GYM25LD-G14-125	●	1
				L	GYHL2525M90-M25R	●	GYM25RD-G14-125	●	1		
		25 *2		14	Modular	R	GYHR2525M90-M25L	●	GYM25LD-G25-125	●	2
				L	GYHL2525M90-M25R	●	GYM25RD-G25-125	●	2		
180	280	14	Modular	R	GYHR2525M90-M25L	●	GYM25LD-G14-180	●	1		
		L	GYHL2525M90-M25R	●	GYM25RD-G14-180	●	1				
25 *2		14	Modular	R	GYHR2525M90-M25L	●	GYM25LD-G25-180	●	2		
		L	GYHL2525M90-M25R	●	GYM25RD-G25-180	●	2				
250	999	14	Modular	R	GYHR2525M90-M25L	●	GYM25LD-G14-250	●	1		
		L	GYHL2525M90-M25R	●	GYM25RD-G14-250	●	1				
25 *2		14	Modular	R	GYHR2525M90-M25L	●	GYM25LD-G25-250	●	2		
		L	GYHL2525M90-M25R	●	GYM25RD-G25-250	●	2				

\*1 Die dargestellten Abmessungen gelten bei der Verwendung von Standard-WSP. Wenn andere WSP-Geometrien verwendet werden, können die Werte für LF, LH und WF variieren.

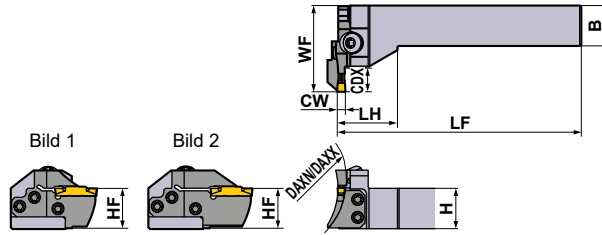
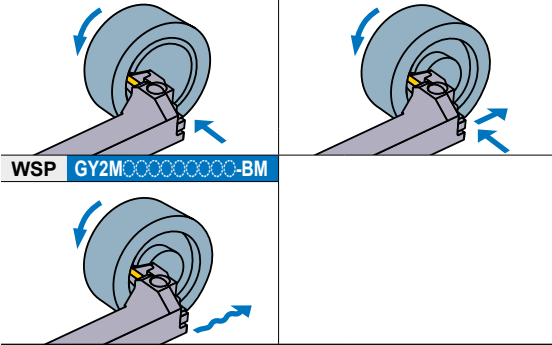
\*2 Die maximale Einstechtiefe (CDX) hängt von der verwendeten Schneidplatte ab. Zur maximalen Einstechtiefe (CDX) bei verschiedenen Schneidplatten siehe Seite F012–F015.

● : Lagerstandard.

\* Schlüssel : ① : Spannschraube, ② : Schraube für Schwert

ERSATZTEILE			
Halter		 5 St.	
	Spannschraube	Schraube für Schwert	Schlüssel*
<b>GYHR2525M90-M25L</b>	GY06013M (Spannmoment : 6.0N·m)	TS55 (Spannmoment : 5.0N·m)	①TKY30R ②TKY25D
<b>GYHL2525M90-M25R</b>			

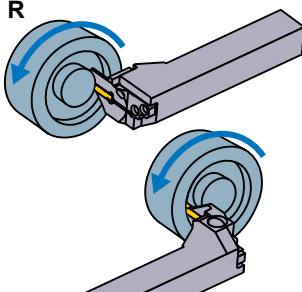
	Abmessungen (mm) *1						Schnittmodus
	H	B	LF	LH	HF	WF	
	25	25	150	38	25	53	<b>R</b> 
	25	25	150	38	25	53	
	25	25	150	38	25	53	
	25	25	150	38	25	53	
	25	25	150	38	25	53	
	25	25	150	38	25	53	
	25	25	150	38	25	64	
	25	25	150	38	25	64	
	25	25	150	38	25	53	
	25	25	150	38	25	53	
	25	25	150	38	25	64	
	25	25	150	38	25	64	
	25	25	150	38	25	53	
	25	25	150	38	25	53	
	25	25	150	38	25	64	
	25	25	150	38	25	64	
	25	25	150	38	25	53	
	25	25	150	38	25	53	
	25	25	150	38	25	64	
	25	25	150	38	25	64	
	25	25	150	38	25	53	
	25	25	150	38	25	53	
	25	25	150	38	25	64	
	25	25	150	38	25	64	
	25	25	150	38	25	53	
	25	25	150	38	25	53	
	25	25	150	38	25	64	
	25	25	150	38	25	64	
	25	25	150	38	25	53	
	25	25	150	38	25	53	
	25	25	150	38	25	64	
	25	25	150	38	25	64	

### WSP-Auswahl

Sitzgröße	<b>Spannbrecher Bezeichnung</b>
G	GY○○0400/0424G○○○○○—Spannbrecher nachstehend abgebildet

Spannbrecher zum Einstechen/Abstechen > F012, F013					
Sitzgröße	Spannbrecher	GU (Für langspannte Stähle)	GS (Kleine Vorschübe)	GM (Mittlere Vorschübe)	GFGS (Cehärteter Stahl)
G	4.00mm	●	●	●	●

Multifunktionsspannbrecher > F014, F015					
Sitzgröße	Spannbrecher	MF (Schlichten)	MS (Kleine Vorschübe)	MM (Mittlere Vorschübe)	BM (Kopierdrehen) Kugelform
G	4.00mm				●
	RE 0.2	●	●	●	
	RE 0.4	●	●	●	
	RE 0.8	●		●	
	4.24mm	●			

● : Standard-WSP mit Abmessungen

EINSTECHEN / ABSTECHE



## GY SERIE (AXIALEINSTECHEN)

### 5

### 90° Ausführung

Hinweis 1) Modulare Schwerter und modulare Halter bitte separat bestellen.  
Hinweis 2) Bitte Modul in Linksausführung für den Halter in Rechtsausführung und Modul in Rechtsausführung für den Halter in Linksausführung verwenden.

WSP	GY2M <sup>GS</sup> <sub>GM</sub>	WSP	GY2G <sup>GS</sup> <sub>GM</sub> -MF
WSP	GY2M <sup>GM</sup> <sub>GFGS</sub> -GU	WSP	GY2M <sup>GM</sup> <sub>GFGS</sub> -MS
WSP	GY1 <sup>M</sup> <sub>G</sub>	WSP	GY2M <sup>GM</sup> <sub>GFGS</sub> -MM



Abb. zeigt Rechtsausführung.



Sitzgröße	Abmessungen (mm)				Typ	Ausführung (R/L)	Bestellbezeichnung				Bild
	CW	DAXN	DAXX	CDX			Halter	Lager	Modulares Schwert	Lager	
H	4.75 5.00 5.24	50	60	14	Modular	R	GYHR2525M90-M25L	●	GYM25LD-H14-050	●	1
				L	GYHL2525M90-M25R	●	GYM25RD-H14-050	●	1		
		60	85	14	Modular	R	GYHR2525M90-M25L	●	GYM25LD-H14-060	●	1
				L	GYHL2525M90-M25R	●	GYM25RD-H14-060	●	1		
		85	125	25 *2	Modular	R	GYHR2525M90-M25L	●	GYM25LD-H25-060	●	2
				L	GYHL2525M90-M25R	●	GYM25RD-H25-060	●	2		
		125	200	14	Modular	R	GYHR2525M90-M25L	●	GYM25LD-H14-085	●	1
				L	GYHL2525M90-M25R	●	GYM25RD-H14-085	●	1		
		180	280	25 *2	Modular	R	GYHR2525M90-M25L	●	GYM25LD-H25-085	●	2
				L	GYHL2525M90-M25R	●	GYM25RD-H25-085	●	2		
		250	999	14	Modular	R	GYHR2525M90-M25L	●	GYM25LD-H14-125	●	1
				L	GYHL2525M90-M25R	●	GYM25RD-H14-125	●	1		
				25 *2	Modular	R	GYHR2525M90-M25L	●	GYM25LD-H25-125	●	2
				L	GYHL2525M90-M25R	●	GYM25RD-H25-125	●	2		
				14	Modular	R	GYHR2525M90-M25L	●	GYM25LD-H14-180	●	1
				L	GYHL2525M90-M25R	●	GYM25RD-H14-180	●	1		
		25 *2	Modular	R	GYHR2525M90-M25L	●	GYM25LD-H25-180	●	2		
		L	GYHL2525M90-M25R	●	GYM25RD-H25-180	●	2				
		14	Modular	R	GYHR2525M90-M25L	●	GYM25LD-H14-250	●	1		
		L	GYHL2525M90-M25R	●	GYM25RD-H14-250	●	1				
		25 *2	Modular	R	GYHR2525M90-M25L	●	GYM25LD-H25-250	●	2		
		L	GYHL2525M90-M25R	●	GYM25RD-H25-250	●	2				

\*1 Die dargestellten Abmessungen gelten bei der Verwendung von Standard-WSP. Wenn andere WSP-Geometrien verwendet werden, können die Werte für LF, LH und WF variieren.

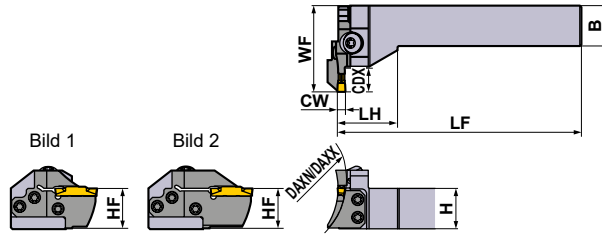
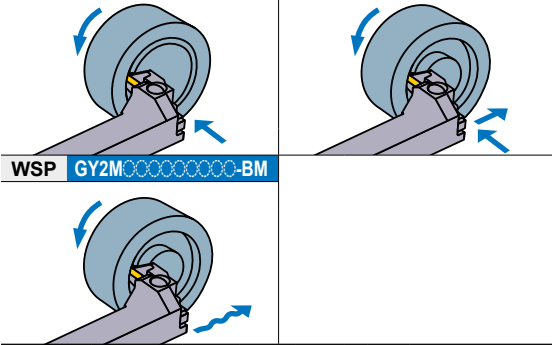
\*2 Die maximale Einstechtiefe (CDX) hängt von der verwendeten Schneidplatte ab. Zur maximalen Einstechtiefe (CDX) bei verschiedenen Schneidplatten siehe Seite F012–F015.

● : Lagerstandard.

\* Schlüssel : ① : Spannschraube, ② : Schraube für Schwert

ERSATZTEILE			
Halter		 5 St.	
	Spannschraube	Schraube für Schwert	Schlüssel*
<b>GYHR2525M90-M25L</b>	GY06013M (Spannmoment : 6.0N·m)	TS55 (Spannmoment : 5.0N·m)	①TKY30R ②TKY25D
<b>GYHL2525M90-M25R</b>			

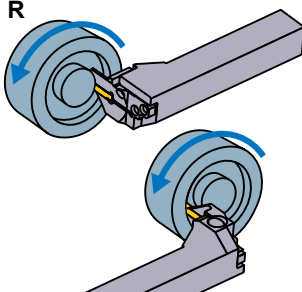
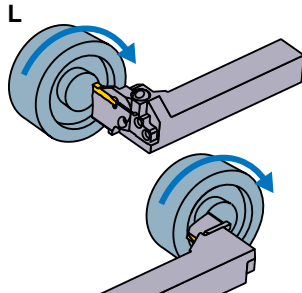
	Abmessungen (mm) *1						Schnittmodus
	H	B	LF	LH	HF	WF	
	25	25	150	38	25	53	<b>R</b> 
	25	25	150	38	25	53	
	25	25	150	38	25	53	
	25	25	150	38	25	53	
	25	25	150	38	25	64	
	25	25	150	38	25	64	
	25	25	150	38	25	53	
	25	25	150	38	25	53	
	25	25	150	38	25	64	
	25	25	150	38	25	64	
	25	25	150	38	25	53	<b>L</b> 
	25	25	150	38	25	53	
	25	25	150	38	25	64	
	25	25	150	38	25	64	
	25	25	150	38	25	64	
	25	25	150	38	25	53	
	25	25	150	38	25	53	
	25	25	150	38	25	64	
	25	25	150	38	25	64	
	25	25	150	38	25	53	

### WSP-Auswahl

Sitzgröße	<b>Spannbrecher Bezeichnung</b>
H	GY <span style="border: 1px solid black; border-radius: 50%; padding: 2px;">0475/0500/0524H</span> <small>Spannbrecher nachstehend abgebildet</small>

Spannbrecher zum Einstechen/Abstechen > F012, F013					
Sitzgröße	Spannbrecher CW	GU	GS	GM	GFGS
		<small>(Für langspannte Stähle)</small>	<small>(Kleine Vorschübe)</small>	<small>(Mittlere Vorschübe)</small>	<small>(Cehärteter Stahl)</small>
H	4.75mm	●	●	●	●
	5.00mm	●	●	●	●

Multifunktionsspannbrecher > F014, F015					
Sitzgröße	Spannbrecher CW	MF	MS	MM	BM
		<small>(Schichten)</small>	<small>(Kleine Vorschübe)</small>	<small>(Mittlere Vorschübe)</small>	<small>(Kopierdrehen)</small>
H	4.75mm				●
	RE 0.2	●			
	RE 0.4	●			
	RE 0.8	●			
	5.00mm				●
	RE 0.2	●			
	RE 0.4	●	●	●	
	RE 0.8	●	●	●	
	5.24mm	●			

● : Standard-WSP mit Abmessungen

EINSTECHEN / ABSTECHE

## GY SERIE (AXIALEINSTECHEN)

### 5

### 90° Ausführung

Hinweis 1) Modulare Schwerter und modulare Halter bitte separat bestellen.  
Hinweis 2) Bitte Modul in Linksausführung für den Halter in Rechtsausführung und Modul in Rechtsausführung für den Halter in Linksausführung verwenden.

WSP	GY2M <sup>GS</sup> <sub>GM</sub>	WSP	GY2G <sup>GS</sup> <sub>GM</sub> -MF
WSP	GY2M <sup>GM</sup> <sub>GFGS</sub> -GU	WSP	GY2M <sup>GM</sup> <sub>GFGS</sub> -MS
WSP	GY1 <sup>GM</sup> <sub>GFGS</sub>	WSP	GY2M <sup>GM</sup> <sub>GFGS</sub> -MM



Abb. zeigt Rechtsausführung.



Sitzgröße	Abmessungen (mm)				Typ	Ausführung (R/L)	Bestellbezeichnung				Bild
	CW	DAXN	DAXX	CDX			Halter	Lager	Modulares Schwert	Lager	
J	6.00	50	70	14	Modular	R	GYHR2525M90-M25L	●	GYM25LD-J14-050	●	1
				L	GYHL2525M90-M25R	●	GYM25RD-J14-050	●	1		
		70	110	14	Modular	R	GYHR2525M90-M25L	●	GYM25LD-J14-070	●	1
				L	GYHL2525M90-M25R	●	GYM25RD-J14-070	●	1		
		110	200	25 *2	Modular	R	GYHR2525M90-M25L	●	GYM25LD-J25-070	●	2
				L	GYHL2525M90-M25R	●	GYM25RD-J25-070	●	2		
	6.31	170	280	14	Modular	R	GYHR2525M90-M25L	●	GYM25LD-J14-110	●	1
				L	GYHL2525M90-M25R	●	GYM25RD-J14-110	●	1		
		110	200	25 *2	Modular	R	GYHR2525M90-M25L	●	GYM25LD-J25-110	●	2
				L	GYHL2525M90-M25R	●	GYM25RD-J25-110	●	2		
		170	280	14	Modular	R	GYHR2525M90-M25L	●	GYM25LD-J14-170	●	1
				L	GYHL2525M90-M25R	●	GYM25RD-J14-170	●	1		
6.35	250	999	14	Modular	R	GYHR2525M90-M25L	●	GYM25LD-J25-170	●	2	
			L	GYHL2525M90-M25R	●	GYM25RD-J25-170	●	2			
250	999	999	14	Modular	R	GYHR2525M90-M25L	●	GYM25LD-J14-250	●	1	
			L	GYHL2525M90-M25R	●	GYM25RD-J14-250	●	1			
250	999	999	25 *2	Modular	R	GYHR2525M90-M25L	●	GYM25LD-J14-250	●	1	
			L	GYHL2525M90-M25R	●	GYM25RD-J14-250	●	1			
250	999	999	25 *2	Modular	R	GYHR2525M90-M25L	●	GYM25LD-J25-250	●	2	
			L	GYHL2525M90-M25R	●	GYM25RD-J25-250	●	2			

\*1 Die dargestellten Abmessungen gelten bei der Verwendung von Standard-WSP. Wenn andere WSP-Geometrien verwendet werden, können die Werte für LF, LH und WF variieren.

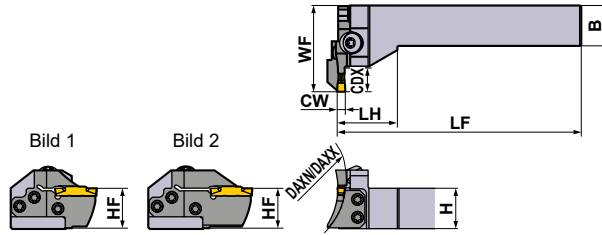
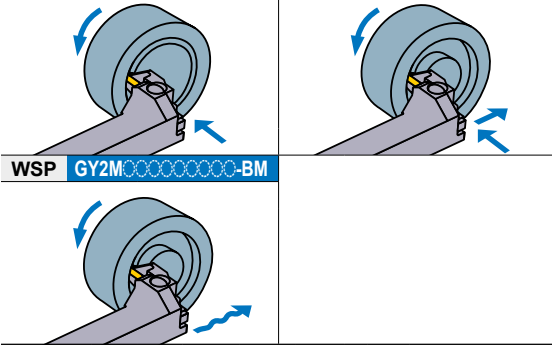
\*2 Die maximale Einstechtiefe (CDX) hängt von der verwendeten Schneidplatte ab. Zur maximalen Einstechtiefe (CDX) bei verschiedenen Schneidplatten siehe Seite F012–F015.

● : Lagerstandard.

\* Schlüssel : ① : Spannschraube, ② : Schraube für Schwert

ERSATZTEILE			
Halter		 5 St.	
	Spannschraube	Schraube für Schwert	Schlüssel*
<b>GYHR2525M90-M25L</b>	GY06013M (Spannmoment : 6.0N·m)	TS55 (Spannmoment : 5.0N·m)	①TKY30R ②TKY25D
<b>GYHL2525M90-M25R</b>			

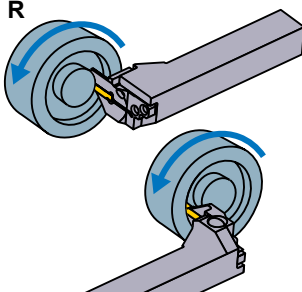
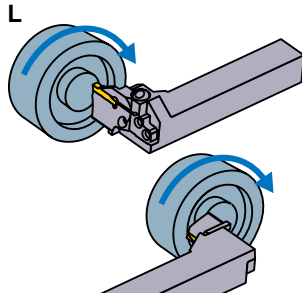
	Abmessungen (mm) *1						Schnittmodus
	H	B	LF	LH	HF	WF	
	25	25	150	38	25	53	
	25	25	150	38	25	53	
	25	25	150	38	25	53	
	25	25	150	38	25	53	
	25	25	150	38	25	64	
	25	25	150	38	25	64	
	25	25	150	38	25	53	
	25	25	150	38	25	53	
	25	25	150	38	25	64	
	25	25	150	38	25	64	
	25	25	150	38	25	53	
	25	25	150	38	25	53	
	25	25	150	38	25	64	
	25	25	150	38	25	64	
	25	25	150	38	25	53	
	25	25	150	38	25	53	
	25	25	150	38	25	64	
	25	25	150	38	25	64	
	25	25	150	38	25	53	
	25	25	150	38	25	53	

### WSP-Auswahl

Sitzgröße	Spannbrecher Bezeichnung
J	GY <span style="border: 1px solid black; border-radius: 50%; padding: 2px;">0600/0631/0635</span> J <span style="border: 1px solid black; border-radius: 50%; padding: 2px;">0600</span> —Spannbrecher nachstehend abgebildet

Spannbrecher zum Einstechen/Abstechen > F012, F013					
Sitzgröße	Spannbrecher CW	GU	GS	GM	GFGS
		(Für langspannte Stähle)	(Kleine Vorschübe)	(Mittlere Vorschübe)	(Cehärteter Stahl)
J	6.00mm	●	●	●	●
	6.35mm	●	●	●	●

Multifunktionsspannbrecher > F014, F015					
Sitzgröße	Spannbrecher CW	MF	MS	MM	BM
		(Schichten)	(Kleine Vorschübe)	(Mittlere Vorschübe)	(Kopierdrehen)
J	6.00mm				●
	RE 0.2	●			
	RE 0.4	●	●	●	
	RE 0.8	●	●	●	
	6.31mm	●			
	6.35mm				●
	RE 0.2	●			
	RE 0.4	●			
	RE 0.8	●			

● : Standard-WSP mit Abmessungen

EINSTECHEN / ABSTECHE

## GY SERIE (INNENEINSTECHEN)

### 6

### 90° Ausführung

WSP	GY2M <sup>GS</sup>	WSP	GY2G <sup>GM</sup>
WSP	GY2M <sup>GL</sup>	WSP	GY2M <sup>MS</sup>
WSP	GY1M <sup>GM</sup>	WSP	GY2M <sup>MM</sup>

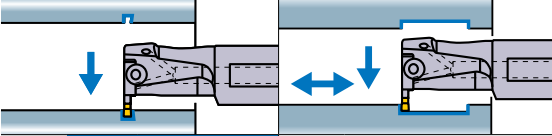

WSP GY2M<sup>BM</sup>

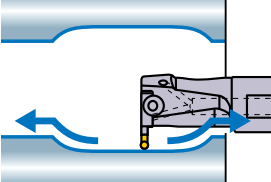

Hinweis 1) Modulare Schwerter und modulare Halter bitte separat bestellen.  
Hinweis 2) Bitte Modul in Linksausführung für den Halter in Rechtsausführung und Modul in Rechtsausführung für den Halter in Linksausführung verwenden.

● Monoblockhalter (Luft- / Kühlmittelzufuhr)



Abb. zeigt Rechtsausführung.

Sitzgröße	Abmessungen (mm)			Typ	Ausführung (R/L)	Bestellbezeichnung				Bild
	CW	CDX *3	DMIN			Halter	Lager	Modulares Schwert	Lager	
D	2.00 2.24	6	25	Einteilig	R	GYAR20K90A-D06	●	—	—	2
				L	GYAL20K90A-D06	●	—	—	2	
			Einteilig	R	GYAR20Q90A-D06	●	—	—	1	
			L	GYAL20Q90A-D06	●	—	—	1		
		32	Einteilig	R	GYAR25K90B-D06	●	—	—	2	
			L	GYAL25K90B-D06	●	—	—	2		
		40	4-9.5 *1	Einteilig	R	GYAR25R90B-D06	●	—	—	1
				L	GYAL25R90B-D06	●	—	—	1	
		40	4-9.5 *1	Modular	R	GYDR32L90C-M20L	●	GYM20LA-D10	●	4
				L	GYDL32L90C-M20R	●	GYM20RA-D10	●	4	
		40	4-9.5 *1	Modular	R	GYDR32S90C-M20L	●	GYM20LA-D10	●	3
				L	GYDL32S90C-M20R	●	GYM20RA-D10	●	3	
	50	5.5-9.5 *1	Modular	R	GYDR40M90D-M20L	●	GYM20LA-D10	●	4	
			L	GYDL40M90D-M20R	●	GYM20RA-D10	●	4		
	50	5.5-9.5 *1	Modular	R	GYDR40T90D-M20L	●	GYM20LA-D10	●	3	
			L	GYDL40T90D-M20R	●	GYM20RA-D10	●	3		
	60	7-11.5 *1	60	Modular	R	GYDR40M90D-M25L	●	GYM25LA-D12	●	4
				L	GYDL40M90D-M25R	●	GYM25RA-D12	●	4	
		Modular	R	GYDR40T90D-M25L	●	GYM25LA-D12	●	3		
		L	GYDL40T90D-M25R	●	GYM25RA-D12	●	3			
70		Modular	R	GYDR50P90F-M25L	●	GYM25LA-D12	●	4		
		L	GYDL50P90F-M25R	●	GYM25RA-D12	●	4			
70	7-11.5 *1	70	Modular	R	GYDR50T90F-M25L	●	GYM25LA-D12	●	3	
			L	GYDL50T90F-M25R	●	GYM25RA-D12	●	3		

\*1 Die maximale Einstechtiefe (CDX) variiert entsprechend des Bearbeitungsdurchmessers (DMIN). Genauere Informationen finden Sie auf Seite F111.

\*2 Die dargestellten Abmessungen gelten bei der Verwendung von Standard-WSP. Wenn andere WSP-Geometrien verwendet werden, können die Werte für LF, LDRED, WF und WF2 variieren.

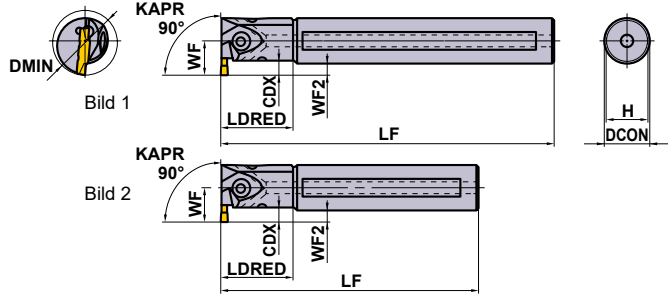
\*3 Die maximale Einstechtiefe (CDX) ist ein Wert im Bereich der Abmessung LDRED.

● : Lagerstandard.

●Modulares Schwert (Luft- / Kühlmittelzufuhr)

\* Schlüssel : ① : Spannschraube, ② : Schraube für Schwert



Abb. zeigt Rechtsausführung.

ERSATZTEILE

Halter	Spannschraube	Schraube für Schwert 4 St.	Schlüssel*
<b>GYAR/L20-90A-06</b>	①GY05016S (Spannmoment : 5.0N·m)	—	①TKY20R
<b>GYAR/L25-90B-06</b>	①GY05016S (Spannmoment : 5.0N·m)	—	①TKY20R
<b>GYDR/L32-90C-M20L/R</b>	②GY06013M (Spannmoment : 6.0N·m)	TS407 (Spannmoment : 3.5N·m)	①TKY30R ②TKY15D
<b>GYDR/L40-90D-M20L/R</b>	②GY06013M (Spannmoment : 6.0N·m)	TS407 (Spannmoment : 3.5N·m)	①TKY30R ②TKY15D
<b>GYDR/L40-90D-M25L/R</b>	②GY06013M (Spannmoment : 6.0N·m)	TS55 (Spannmoment : 5.0N·m)	①TKY30R ②TKY25D
<b>GYDR/L50-90F-M25L/R</b>	②GY06013M (Spannmoment : 6.0N·m)	TS55 (Spannmoment : 5.0N·m)	①TKY30R ②TKY25D

	Abmessungen (mm) *2						Schnittmodus
	DCON	LF	LDRED	WF	WF2	H	
	20	125	30	14.5	4.5	18	R
	20	125	30	14.5	4.5	18	
	20	180	30	14.5	4.5	18	
	20	180	30	14.5	4.5	18	
	25	125	40	19	6.5	23	R
	25	125	40	19	6.5	23	
	25	200	40	19	6.5	23	
	25	200	40	19	6.5	23	
	32	140	50	22	6	30	L
	32	140	50	22	6	30	
	32	250	50	22	6	30	
	32	250	50	22	6	30	
	40	150	60	28	8	37	L
	40	150	60	28	8	37	
	40	300	60	28	8	37	
	40	300	60	28	8	37	
	40	150	60	28	8	37	L
	40	150	60	28	8	37	
	40	300	60	28	8	37	
	40	300	60	28	8	37	
	50	170	80	34	9	47	L
	50	170	80	34	9	47	
	50	300	80	34	9	47	
	50	300	80	34	9	47	

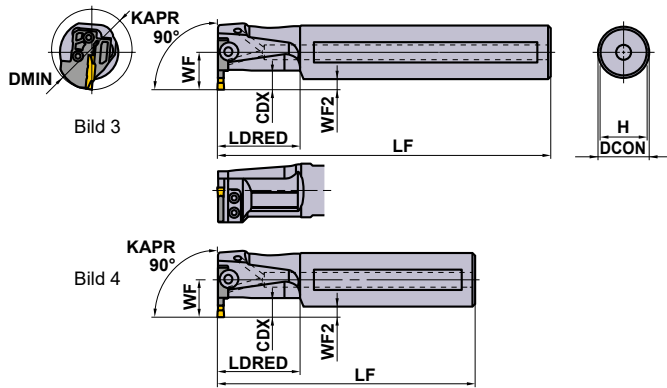
WSP-Auswahl

Sitzgröße	Spannbrecher Bezeichnung
D	GY-0200/0224D- -Spannbrecher nachstehend abgebildet

Spannbrecher zum Einstechen/Abstechen > F012, F013						
Sitzgröße	Spannbrecher	GU (Für langspannende Sähe)	GS (Kleine Vorschübe)	GM (Mittlere Vorschübe)	GL (Aluminium-legierung)	GFGS (Gehärteter Stahl)
D	2.00mm	●	●	●	●	●

Multifunktionsspannbrecher > F014, F015					
Sitzgröße	Spannbrecher	MF (Schlichten)	MS (Kleine Vorschübe)	MM (Mittlere Vorschübe)	BM (Kopierdrehen)
D	2.00mm	●	●	●	●
	2.24mm	●	●	●	●

● : Standard-WSP mit Abmessungen

IDENTIFIKATION > F008, F009  
 SCHNITTBEDINGUNGEN > F110  
 SICHERHEITSHINWEISE > F112

## GY SERIE (INNENEINSTECHEN)

### 6

### 90° Ausführung

WSP	GY2M <sup>GS</sup>	WSP	GY2G <sup>MF</sup>
WSP	GY2M <sup>GL</sup>	WSP	GY2M <sup>MS</sup>
WSP	GY1M <sup>GM</sup>	WSP	GY2M <sup>MM</sup>

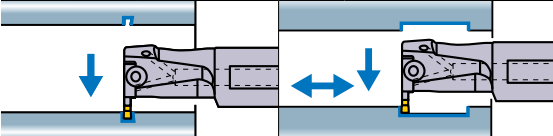

WSP GY2M<sup>BM</sup>

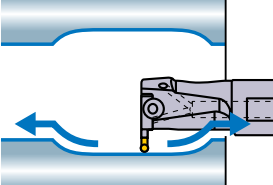

Hinweis 1) Modulare Schwerter und modulare Halter bitte separat bestellen.  
Hinweis 2) Bitte Modul in Linksausführung für den Halter in Rechtsausführung und Modul in Rechtsausführung für den Halter in Linksausführung verwenden.

● Monoblockhalter (Luft- / Kühlmittelzufuhr)



Abb. zeigt Rechtsausführung.

Sitzgröße	Abmessungen (mm)			Typ	Ausführung (R/L)	Bestellbezeichnung				Bild
	CW	CDX *3	DMIN			Halter	Lager	Modulares Schwert	Lager	
E	2.39	6	25	Einteilig	R	GYAR20K90A-E06	●	—	—	2
				L	GYAL20K90A-E06	●	—	—	2	
			Einteilig	R	GYAR20Q90A-E06	●	—	—	1	
			L	GYAL20Q90A-E06	●	—	—	1		
		32	Einteilig	R	GYAR25K90B-E06	●	—	—	2	
			L	GYAL25K90B-E06	●	—	—	2		
		4-9.5 *1	40	Modular	R	GYDR32L90C-M20L	●	GYM20LA-E10	●	4
				L	GYDL32L90C-M20R	●	GYM20RA-E10	●	4	
	Modular		R	GYDR32S90C-M20L	●	GYM20LA-E10	●	3		
	L		GYDL32S90C-M20R	●	GYM20RA-E10	●	3			
	5.5-9.5 *1	50	Modular	R	GYDR40M90D-M20L	●	GYM20LA-E10	●	4	
			L	GYDL40M90D-M20R	●	GYM20RA-E10	●	4		
		Modular	R	GYDR40T90D-M20L	●	GYM20LA-E10	●	3		
		L	GYDL40T90D-M20R	●	GYM20RA-E10	●	3			
	7-11.5 *1	60	Modular	R	GYDR40M90D-M25L	●	GYM25LA-E12	●	4	
			L	GYDL40M90D-M25R	●	GYM25RA-E12	●	4		
		Modular	R	GYDR40T90D-M25L	●	GYM25LA-E12	●	3		
		L	GYDL40T90D-M25R	●	GYM25RA-E12	●	3			
		70	Modular	R	GYDR50P90F-M25L	●	GYM25LA-E12	●	4	
			L	GYDL50P90F-M25R	●	GYM25RA-E12	●	4		
2.50	7-11.5 *1	70	Modular	R	GYDR50T90F-M25L	●	GYM25LA-E12	●	3	
L			GYDL50T90F-M25R	●	GYM25RA-E12	●	3			
2.74	7-11.5 *1	70	Modular	R	GYDR50P90F-M25L	●	GYM25LA-E12	●	4	
L			GYDL50P90F-M25R	●	GYM25RA-E12	●	4			

\*1 Die maximale Einstechtiefe (CDX) variiert entsprechend des Bearbeitungsdurchmessers (DMIN). Genauere Informationen finden Sie auf Seite F111.

\*2 Die dargestellten Abmessungen gelten bei der Verwendung von Standard-WSP. Wenn andere WSP-Geometrien verwendet werden, können die Werte für LF, LDRED, WF und WF2 variieren.

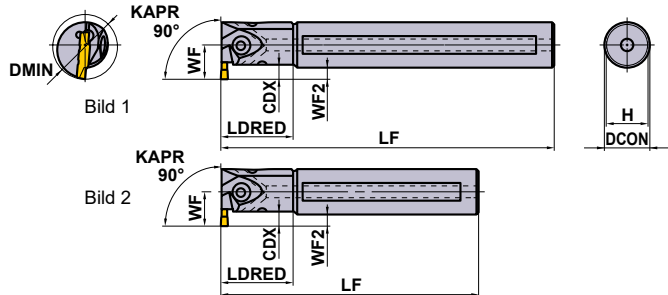
\*3 Die maximale Einstechtiefe (CDX) ist ein Wert im Bereich der Abmessung LDRED.

● : Lagerstandard.





## GY SERIE (INNENEINSTECHEN)

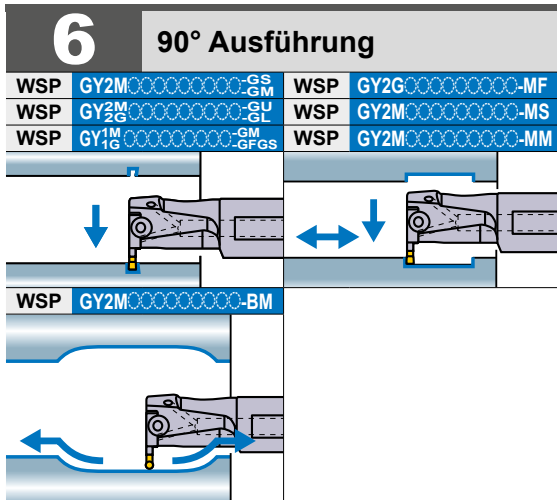

Hinweis 1) Modulare Schwerter und modulare Halter bitte separat bestellen.  
Hinweis 2) Bitte Modul in Linksausführung für den Halter in Rechtsausführung und Modul in Rechtsausführung für den Halter in Linksausführung verwenden.

### ● Monoblockhalter (Luft- / Kühlmittelzufuhr)



Abb. zeigt Rechtsausführung.

Sitzgröße	Abmessungen (mm)			Typ	Ausführung (R/L)	Bestellbezeichnung				Bild
	CW	CDX *3	DMIN			Halter	Lager	Modulares Schwert	Lager	
F	3.00 3.18 3.24	6	25	Einteilig	R	GYAR20K90A-F06	●	—	—	2
				Einteilig	L	GYAL20K90A-F06	●	—	—	2
				Einteilig	R	GYAR20Q90A-F06	●	—	—	1
				Einteilig	L	GYAL20Q90A-F06	●	—	—	1
			Einteilig	R	GYAR25K90B-F06	●	—	—	2	
			Einteilig	L	GYAL25K90B-F06	●	—	—	2	
		4—9.5 *1	40	Modular	R	GYDR32L90C-M20L	●	GYM20LA-F10	●	4
				Modular	L	GYDL32L90C-M20R	●	GYM20RA-F10	●	4
			Modular	R	GYDR32S90C-M20L	●	GYM20LA-F10	●	3	
				L	GYDL32S90C-M20R	●	GYM20RA-F10	●	3	
			Modular	R	GYDR40M90D-M20L	●	GYM20LA-F10	●	4	
				L	GYDL40M90D-M20R	●	GYM20RA-F10	●	4	
	5.5—9.5 *1	50	Modular	R	GYDR40T90D-M20L	●	GYM20LA-F10	●	3	
			Modular	L	GYDL40T90D-M20R	●	GYM20RA-F10	●	3	
		Modular	R	GYDR40M90D-M25L	●	GYM25LA-F12	●	4		
			L	GYDL40M90D-M25R	●	GYM25RA-F12	●	4		
		Modular	R	GYDR40T90D-M25L	●	GYM25LA-F12	●	3		
			L	GYDL40T90D-M25R	●	GYM25RA-F12	●	3		
7—11.5 *1	60	Modular	R	GYDR50P90F-M25L	●	GYM25LA-F12	●	4		
		Modular	L	GYDL50P90F-M25R	●	GYM25RA-F12	●	4		
	Modular	R	GYDR50T90F-M25L	●	GYM25LA-F12	●	3			
		L	GYDL50T90F-M25R	●	GYM25RA-F12	●	3			
	Modular	R	GYDR50P90F-M25L	●	GYM25LA-F12	●	4			
		L	GYDL50P90F-M25R	●	GYM25RA-F12	●	4			
G	4.00 4.24	7	Einteilig	R	GYAR25K90B-G07	●	—	—	2	
			Einteilig	L	GYAL25K90B-G07	●	—	—	2	
			Einteilig	R	GYAR25R90B-G07	●	—	—	1	
			Einteilig	L	GYAL25R90B-G07	●	—	—	1	
		4.5—11.5 *1	40	Modular	R	GYDR32L90C-M20L	●	GYM20LA-G12	●	4
				Modular	L	GYDL32L90C-M20R	●	GYM20RA-G12	●	4
			Modular	R	GYDR32S90C-M20L	●	GYM20LA-G12	●	3	
				L	GYDL32S90C-M20R	●	GYM20RA-G12	●	3	
		6—11.5 *1	50	Modular	R	GYDR40M90D-M20L	●	GYM20LA-G12	●	4
				Modular	L	GYDL40M90D-M20R	●	GYM20RA-G12	●	4
			Modular	R	GYDR40T90D-M20L	●	GYM20LA-G12	●	3	
				L	GYDL40T90D-M20R	●	GYM20RA-G12	●	3	
	7.5—13 *1	60	Modular	R	GYDR40M90D-M25L	●	GYM25LA-G14	●	4	
			Modular	L	GYDL40M90D-M25R	●	GYM25RA-G14	●	4	
		Modular	R	GYDR40T90D-M25L	●	GYM25LA-G14	●	3		
			L	GYDL40T90D-M25R	●	GYM25RA-G14	●	3		
		Modular	R	GYDR50P90F-M25L	●	GYM25LA-G14	●	4		
			L	GYDL50P90F-M25R	●	GYM25RA-G14	●	4		
Modular	R	GYDR50T90F-M25L	●	GYM25LA-G14	●	3				
	L	GYDL50T90F-M25R	●	GYM25RA-G14	●	3				

\*1 Die maximale Einstechtiefe (CDX) variiert entsprechend des Bearbeitungsdurchmessers (DMIN). Genauere Informationen finden Sie auf Seite F111.

\*2 Die dargestellten Abmessungen gelten bei der Verwendung von Standard-WSP. Wenn andere WSP-Geometrien verwendet werden, können die Werte für LF, LDRED, WF und WF2 variieren.

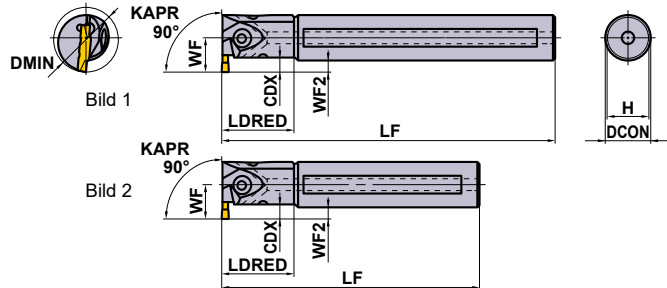
\*3 Die maximale Einstechtiefe (CDX) ist ein Wert im Bereich der Abmessung LDRED.

● : Lagerstandard.

● Modulares Schwert (Luft- / Kühlmittelzufuhr)

\* Schlüssel : ① : Spannschraube, ② : Schraube für Schwert



Abb. zeigt Rechtsausführung.

ERSATZTEILE

Halter	①	②	①
	Spannschraube	Schraube für Schwert	Schlüssel*
GYAR/L20○90A-F06	①GY05016S (Spannmoment : 5.0N·m)	—	①TKY20R
GYAR/L25○90B-○○○	—	—	—
GYDR/L32○90C-M20L/R	②GY06013M (Spannmoment : 6.0N·m)	TS407 (Spannmoment : 3.5N·m)	①TKY30R ②TKY15D
GYDR/L40○90D-M20L/R	②GY06013M (Spannmoment : 6.0N·m)	TS55 (Spannmoment : 5.0N·m)	①TKY30R ②TKY25D
GYDR/L50○90F-M25L/R	②GY06013M (Spannmoment : 6.0N·m)	—	—

	Abmessungen (mm) *2						Schnittmodus
	DCON	LF	LDRED	WF	WF2	H	
	20	125	30	14.5	4.5	18	R
	20	125	30	14.5	4.5	18	
	20	180	30	14.5	4.5	18	
	20	180	30	14.5	4.5	18	
	25	125	40	19	6.5	23	
	25	125	40	19	6.5	23	
	25	200	40	19	6.5	23	
	25	200	40	19	6.5	23	
	32	140	50	22	6	30	
	32	140	50	22	6	30	
	32	250	50	22	6	30	
	32	250	50	22	6	30	
	40	150	60	28	8	37	
	40	150	60	28	8	37	
	40	300	60	28	8	37	
	40	300	60	28	8	37	
	40	150	60	28	8	37	
	40	150	60	28	8	37	
	40	300	60	28	8	37	
	40	300	60	28	8	37	
	50	170	80	34	9	47	
	50	170	80	34	9	47	
	50	300	80	34	9	47	
	50	300	80	34	9	47	
	25	125	40	19	6.5	23	L
	25	125	40	19	6.5	23	
	25	200	40	19	6.5	23	
	25	200	40	19	6.5	23	
	32	140	50	22	6	30	
	32	140	50	22	6	30	
	32	250	50	22	6	30	
	32	250	50	22	6	30	
	40	150	60	28	8	37	
	40	150	60	28	8	37	
	40	300	60	28	8	37	
	40	300	60	28	8	37	
	40	150	60	28	8	37	
	40	150	60	28	8	37	
	40	300	60	28	8	37	
	40	300	60	28	8	37	
	40	150	60	28	8	37	
	40	150	60	28	8	37	
	40	300	60	28	8	37	
	40	300	60	28	8	37	
	50	170	80	34	9	47	
	50	170	80	34	9	47	
	50	300	80	34	9	47	
	50	300	80	34	9	47	

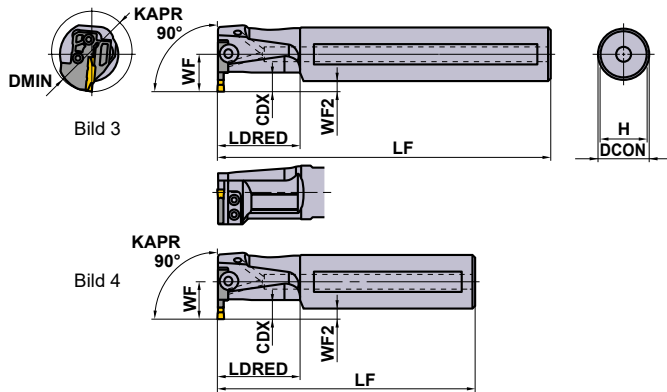

WSP-Auswahl

Sitzgröße	Spannbrecher Bezeichnung
F	GY○○0300/0318/0324F○○○○○—Spannbrecher nachstehend abgebildet

Spannbrecher zum Einstechen/Abstechen > F012, F013						
Sitzgröße	Spannbrecher	GU (Für langspanende Stähle)	GS (Kleine Vorschübe)	GM (Mittlere Vorschübe)	GL (Aluminium- legierung)	GFGS (Gehärteter Stahl)
F	3.00mm	●	●	●	●	●
	3.18mm	●	●	●	●	●

Multifunktionsspannbrecher > F014, F015					
Sitzgröße	Spannbrecher	MF (Schichten)	MS (Kleine Vorschübe)	MM (Mittlere Vorschübe)	BM (Kopierdrehen)
F	3.00mm				●
	RE 0.2	●	●	●	
	RE 0.4	●	●	●	
	RE 0.8			●	
	3.18mm				●
	3.24mm	●			

Sitzgröße	Spannbrecher Bezeichnung
G	GY○○0400/0424G○○○○○—Spannbrecher nachstehend abgebildet

Spannbrecher zum Einstechen/Abstechen > F012, F013					
Sitzgröße	Spannbrecher	GU (Für langspanende Stähle)	GS (Kleine Vorschübe)	GM (Mittlere Vorschübe)	GFGS (Gehärteter Stahl)
G	4.00mm	●	●	●	●

Multifunktionsspannbrecher > F014, F015					
Sitzgröße	Spannbrecher	MF (Schichten)	MS (Kleine Vorschübe)	MM (Mittlere Vorschübe)	BM (Kopierdrehen)
G	4.00mm				●
	RE 0.2	●	●	●	
	RE 0.4	●	●	●	
	RE 0.8	●		●	
	4.24mm	●			

● : Standard-WSP mit Abmessungen

IDENTIFIKATION > F008, F009  
 SCHNITTBEDINGUNGEN > F110  
 SICHERHEITSHINWEISE > F112

EINSTECHEN / ABSTECHE

# GY SERIE (INNENEINSTECHEN)

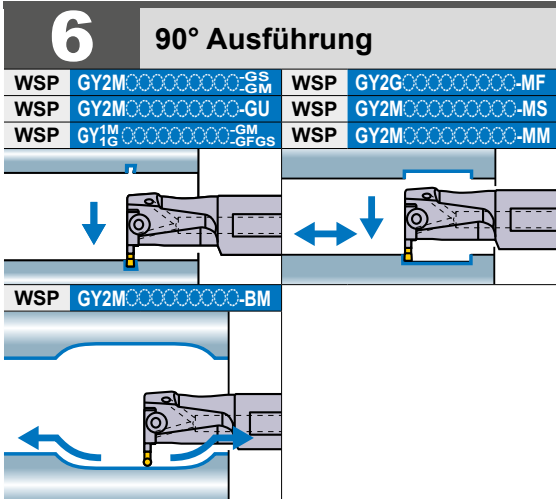

Hinweis 1) Modulare Schwerter und modulare Halter bitte separat bestellen.  
Hinweis 2) Bitte Modul in Linksausführung für den Halter in Rechtsausführung und Modul in Rechtsausführung für den Halter in Linksausführung verwenden.

● Monoblockhalter (Luft- / Kühlmittelzufuhr)



Abb. zeigt Rechtsausführung.

Sitzgröße	Abmessungen (mm)			Typ	Ausführung (R/L)	Bestellbezeichnung				Bild
	CW	CDX *3	DMIN			Halter	Lager	Modulares Schwert	Lager	
H	4.75 5.00 5.24	7	32	Einteilig	R	GYAR25K90B-H07	●	—	—	2
				L	GYAL25K90B-H07	●	—	—	2	
		4.5—11.5 *1	40	Einteilig	R	GYAR25R90B-H07	●	—	—	1
				L	GYAL25R90B-H07	●	—	—	1	
		6—11.5 *1	50	Modular	R	GYDR32L90C-M20L	●	GYM20LA-H12	●	4
				L	GYDL32L90C-M20R	●	GYM20RA-H12	●	4	
	7.5—13 *1	60	Modular	R	GYDR32S90C-M20L	●	GYM20LA-H12	●	3	
			L	GYDL32S90C-M20R	●	GYM20RA-H12	●	3		
	6.00 6.31 6.35	7.5—13 *1	70	Modular	R	GYDR40M90D-M20L	●	GYM20LA-H12	●	4
				L	GYDL40M90D-M20R	●	GYM20RA-H12	●	4	
			Modular	R	GYDR40T90D-M20L	●	GYM20LA-H12	●	3	
			L	GYDL40T90D-M20R	●	GYM20RA-H12	●	3		
		7.5—13 *1	60	Modular	R	GYDR40M90D-M25L	●	GYM25LA-H14	●	4
				L	GYDL40M90D-M25R	●	GYM25RA-H14	●	4	
			Modular	R	GYDR40T90D-M25L	●	GYM25LA-H14	●	3	
			L	GYDL40T90D-M25R	●	GYM25RA-H14	●	3		
7.5—13 *1	70	Modular	R	GYDR50P90F-M25L	●	GYM25LA-H14	●	4		
		L	GYDL50P90F-M25R	●	GYM25RA-H14	●	4			
	Modular	R	GYDR50T90F-M25L	●	GYM25LA-H14	●	3			
	L	GYDL50T90F-M25R	●	GYM25RA-H14	●	3				
J	7.5—13 *1	60	Modular	R	GYDR40M90D-M25L	●	GYM25LA-J14	●	4	
			L	GYDL40M90D-M25R	●	GYM25RA-J14	●	4		
		Modular	R	GYDR40T90D-M25L	●	GYM25LA-J14	●	3		
		L	GYDL40T90D-M25R	●	GYM25RA-J14	●	3			
	7.5—13 *1	70	Modular	R	GYDR50P90F-M25L	●	GYM25LA-J14	●	4	
			L	GYDL50P90F-M25R	●	GYM25RA-J14	●	4		
		Modular	R	GYDR50T90F-M25L	●	GYM25LA-J14	●	3		
		L	GYDL50T90F-M25R	●	GYM25RA-J14	●	3			

\*1 Die maximale Einstechtiefe (CDX) variiert entsprechend des Bearbeitungsdurchmessers (DMIN). Genauere Informationen finden Sie auf Seite F111.

\*2 Die dargestellten Abmessungen gelten bei der Verwendung von Standard-WSP. Wenn andere WSP-Geometrien verwendet werden, können die Werte für LF, LDRED, WF und WF2 variieren.

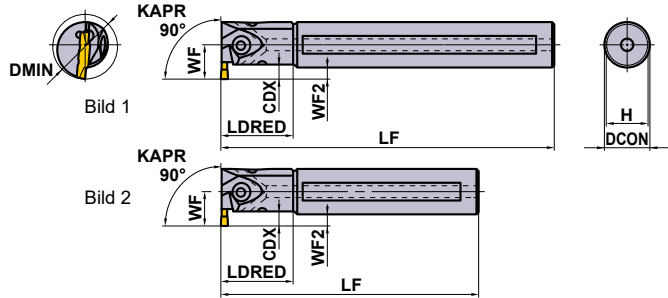
\*3 Die maximale Einstechtiefe (CDX) ist ein Wert im Bereich der Abmessung LDRED.

● : Lagerstandard.

EINSTECHEN / ABSTECHEN

● Modulares Schwert (Luft- / Kühlmittelzufuhr)

\* Schlüssel : ① : Spannschraube, ② : Schraube für Schwert



Abb. zeigt Rechtsausführung.

ERSATZTEILE

Halter	Spannschraube	Schraube für Schwert	Schlüssel*
GYAR/L25○90B-○07	①GY05016S (Spannmoment : 5.0N·m)	—	①TKY20R
GYDR/L32○90C-M20L/R	②GY06013M (Spannmoment : 6.0N·m)	TS407 (Spannmoment : 3.5N·m)	①TKY30R ②TKY15D
GYDR/L40○90D-M20L/R	②GY06013M (Spannmoment : 6.0N·m)	TS55 (Spannmoment : 5.0N·m)	①TKY30R ②TKY25D
GYDR/L50○90F-M25L/R	②GY06013M (Spannmoment : 6.0N·m)	TS55 (Spannmoment : 5.0N·m)	①TKY30R ②TKY25D

	Abmessungen (mm) *2						Schnittmodus
	DCON	LF	LDRED	WF	WF2	H	
	25	125	40	19	6.5	23	R
	25	125	40	19	6.5	23	
	25	200	40	19	6.5	23	
	25	200	40	19	6.5	23	
	32	140	50	22	6	30	L
	32	140	50	22	6	30	
	32	250	50	22	6	30	
	32	250	50	22	6	30	
	40	150	60	28	8	37	
	40	150	60	28	8	37	
	40	300	60	28	8	37	
	40	300	60	28	8	37	
	40	150	60	28	8	37	
	40	150	60	28	8	37	
	40	300	60	28	8	37	
	40	300	60	28	8	37	
	50	170	80	34	9	47	
	50	170	80	34	9	47	
	50	300	80	34	9	47	
	50	300	80	34	9	47	
	40	150	60	28	8	37	
	40	150	60	28	8	37	
	40	300	60	28	8	37	
	40	300	60	28	8	37	
	50	170	80	34	9	47	
	50	170	80	34	9	47	
	50	300	80	34	9	47	
	50	300	80	34	9	47	

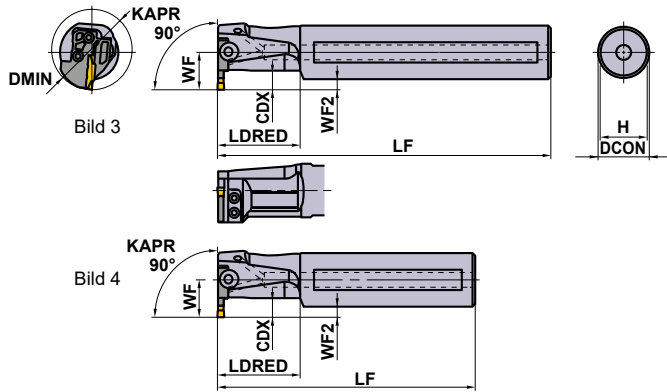
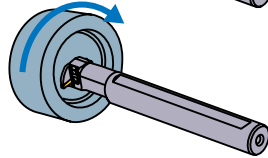
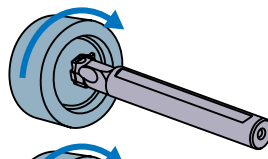
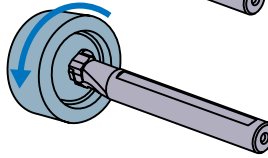
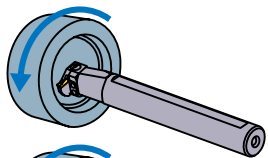

WSP-Auswahl

Sitzgröße	Spannbrecher Bezeichnung
H	GY○○○0475/0500/0524H○○○○○—Spannbrecher nachstehend abgebildet

Spannbrecher zum Einstechen/Abstechen > F012, F013					
Sitzgröße	Spannbrecher CW	GU	GS	GM	GFGS
		(Für langspandente Stähle)	(Kleine Vorschübe)	(Mittlere Vorschübe)	(Gehärteter Stahl)
H	4.75mm	●	●	●	●
	5.00mm	●	●	●	●

Multifunktionsspannbrecher > F014, F015					
Sitzgröße	Spannbrecher CW	MF	MS	MM	BM
		(Schlichten)	(Kleine Vorschübe)	(Mittlere Vorschübe)	(Kopierdrehen)
H	4.75mm				●
	RE 0.2	●			
	RE 0.4	●			
	RE 0.8	●			
	5.00mm				●
	RE 0.2	●			
	RE 0.4	●	●	●	
	RE 0.8	●	●	●	
5.24mm	●				

Sitzgröße	Spannbrecher Bezeichnung
J	GY○○○0600/0631/0635J○○○○○—Spannbrecher nachstehend abgebildet

Spannbrecher zum Einstechen/Abstechen > F012, F013					
Sitzgröße	Spannbrecher CW	GU	GS	GM	GFGS
		(Für langspandente Stähle)	(Kleine Vorschübe)	(Mittlere Vorschübe)	(Gehärteter Stahl)
J	6.00mm	●	●	●	
	6.35mm	●	●	●	

Multifunktionsspannbrecher > F014, F015					
Sitzgröße	Spannbrecher CW	MF	MS	MM	BM
		(Schlichten)	(Kleine Vorschübe)	(Mittlere Vorschübe)	(Kopierdrehen)
J	6.00mm				●
	RE 0.2	●			
	RE 0.4	●	●	●	
	RE 0.8	●	●	●	
	6.31mm	●			
	6.35mm				●
	RE 0.2	●			
	RE 0.4	●			
RE 0.8	●				

● : Standard-WSP mit Abmessungen

IDENTIFIKATION > F008, F009  
 SCHNITTBEDINGUNGEN > F110  
 SICHERHEITSHINWEISE > F112

EINSTECHEN / ABSTECHE

## GY SERIE (AUSSEN / AXIALEINSTECHEN)

**PSC** 00° Ausführung

**NEW**

Hinweis 1) Bitte das Stechmodul und den modularen Halter getrennt bestellen.

Hinweis 2) Bitte das Stechmodul in Rechtsausführung für den Halter in Rechtsausführung und das Stechmodul in Linksausführung für den Halter in Linksausführung zusammenstellen.



Abb. zeigt Rechtsausführung.

(mm)

Bestellbezeichnung	Lager	Ausführung (R/L)	Kühlmittel	Anbindung	DCONMS	CW
C4-GYHERM00-M25R	●	R	Aussen	PSC40	40	2.0–6.35
C4-GYHELM00-M25L	●	L	Aussen	PSC40	40	2.0–6.35
C5-GYHERM00-M25R	●	R	Aussen	PSC50	50	2.0–6.35
C5-GYHELM00-M25L	●	L	Aussen	PSC50	50	2.0–6.35
C6-GYHERM00-M25R	●	R	Aussen	PSC60	60	2.0–6.35
C6-GYHELM00-M25L	●	L	Aussen	PSC60	60	2.0–6.35

EINSTECHEN / ABSTECHEN

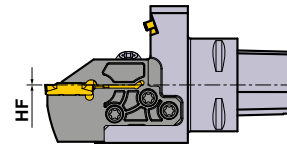
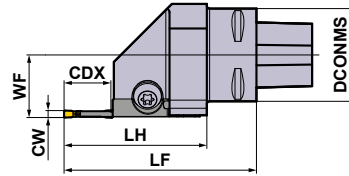
### Abmessungen für modulare Ausführungen

Halteausführung	Typ des modularen Schwertes	Standard CW	CDX	WF	HF	LF	LH
C4-GYHER/LM00-M25R/L	GYM25R/L○-D06	2.0	6	27.0	0	69	47.6
C4-GYHER/LM00-M25R/L	GYM25R/L○-D12	2.0	12	27.0	0	77	55.6
C4-GYHER/LM00-M25R/L	GYM25R/L○-D20	2.0	20	27.0	0	83	61.6
C4-GYHER/LM00-M25R/L	GYM25R/L○-E06	2.5	6	27.0	0	69	47.6
C4-GYHER/LM00-M25R/L	GYM25R/L○-E12	2.5	12	27.0	0	77	55.6
C4-GYHER/LM00-M25R/L	GYM25R/L○-E20	2.5	20	27.0	0	83	61.6
C4-GYHER/LM00-M25R/L	GYM25R/L○-F06	3.0	6	27.0	0	69	47.6
C4-GYHER/LM00-M25R/L	GYM25R/L○-F12	3.0	12	27.0	0	77	55.6
C4-GYHER/LM00-M25R/L	GYM25R/L○-F20	3.0	20	27.0	0	83	61.6
C4-GYHER/LM00-M25R/L	GYM25R/L○-G08	4.0	8	27.0	0	71	49.6
C4-GYHER/LM00-M25R/L	GYM25R/L○-G14	4.0	14	27.0	0	77	55.6
C4-GYHER/LM00-M25R/L	GYM25R/L○-G25	4.0	25	27.0	0	88	66.6
C4-GYHER/LM00-M25R/L	GYM25R/L○-H08	5.0	8	27.0	0	71	49.6
C4-GYHER/LM00-M25R/L	GYM25R/L○-H14	5.0	14	27.0	0	77	55.6
C4-GYHER/LM00-M25R/L	GYM25R/L○-H25	5.0	25	27.0	0	88	66.6
C4-GYHER/LM00-M25R/L	GYM25R/L○-J08	6.0	8	27.0	0	71	49.6
C4-GYHER/LM00-M25R/L	GYM25R/L○-J14	6.0	14	27.0	0	77	55.6
C4-GYHER/LM00-M25R/L	GYM25R/L○-J25	6.0	25	27.0	0	88	66.6

\*Stechmodule für Axialeinstiche richten sich nach dem Mindestaxialeinstechdurchmesser. Beispiel: GYM25RD-D12-040

Das Symbol „o“ steht als Platzhalter in der Bezeichnung. Der Platzhalter kann mit „A“ für Außenstechen und „D“ für Axialeinstechen beschrieben werden.

Hinweis 1) Die angegebenen Abmessungen sind Werte für Standard-WSP (GM-Spanbrecher). Wenn andere WSP angebracht sind, können LF und LH abweichen.

● : Lagerstandard.



(mm)

Halteausführung	Typ des modularen Schwertes	Standard CW	CDX	WF	HF	LF	LH
C5-GYHER/LM00-M25R/L	GYM25R/LO-D06	2.0	6	35.0	0	69	47.6
C5-GYHER/LM00-M25R/L	GYM25R/LO-D12	2.0	12	35.0	0	77	55.6
C5-GYHER/LM00-M25R/L	GYM25R/LO-D20	2.0	20	35.0	0	83	61.6
C5-GYHER/LM00-M25R/L	GYM25R/LO-E06	2.5	6	35.0	0	69	47.6
C5-GYHER/LM00-M25R/L	GYM25R/LO-E12	2.5	12	35.0	0	77	55.6
C5-GYHER/LM00-M25R/L	GYM25R/LO-E20	2.5	20	35.0	0	83	61.6
C5-GYHER/LM00-M25R/L	GYM25R/LO-F06	3.0	6	35.0	0	69	47.6
C5-GYHER/LM00-M25R/L	GYM25R/LO-F12	3.0	12	35.0	0	77	55.6
C5-GYHER/LM00-M25R/L	GYM25R/LO-F20	3.0	20	35.0	0	83	61.6
C5-GYHER/LM00-M25R/L	GYM25R/LO-G08	4.0	8	35.0	0	71	49.6
C5-GYHER/LM00-M25R/L	GYM25R/LO-G14	4.0	14	35.0	0	77	55.6
C5-GYHER/LM00-M25R/L	GYM25R/LO-G25	4.0	25	35.0	0	88	66.6
C5-GYHER/LM00-M25R/L	GYM25R/LO-H08	5.0	8	35.0	0	71	49.6
C5-GYHER/LM00-M25R/L	GYM25R/LO-H14	5.0	14	35.0	0	77	55.6
C5-GYHER/LM00-M25R/L	GYM25R/LO-H25	5.0	25	35.0	0	88	66.6
C5-GYHER/LM00-M25R/L	GYM25R/LO-J08	6.0	8	35.0	0	71	49.6
C5-GYHER/LM00-M25R/L	GYM25R/LO-J14	6.0	14	35.0	0	77	55.6
C5-GYHER/LM00-M25R/L	GYM25R/LO-J25	6.0	25	35.0	0	88	66.6
C6-GYHER/LM00-M25R/L	GYM25R/LO-D06	2.0	6	45.0	0	71	47.6
C6-GYHER/LM00-M25R/L	GYM25R/LO-D12	2.0	12	45.0	0	79	55.6
C6-GYHER/LM00-M25R/L	GYM25R/LO-D20	2.0	20	45.0	0	85	61.6
C6-GYHER/LM00-M25R/L	GYM25R/LO-E06	2.5	6	45.0	0	71	47.6
C6-GYHER/LM00-M25R/L	GYM25R/LO-E12	2.5	12	45.0	0	79	55.6
C6-GYHER/LM00-M25R/L	GYM25R/LO-E20	2.5	20	45.0	0	85	61.6
C6-GYHER/LM00-M25R/L	GYM25R/LO-F06	3.0	6	45.0	0	71	47.6
C6-GYHER/LM00-M25R/L	GYM25R/LO-F12	3.0	12	45.0	0	79	55.6
C6-GYHER/LM00-M25R/L	GYM25R/LO-F20	3.0	20	45.0	0	85	61.6
C6-GYHER/LM00-M25R/L	GYM25R/LO-G08	4.0	8	45.0	0	73	49.6
C6-GYHER/LM00-M25R/L	GYM25R/LO-G14	4.0	14	45.0	0	79	55.6
C6-GYHER/LM00-M25R/L	GYM25R/LO-G25	4.0	25	45.0	0	90	66.6
C6-GYHER/LM00-M25R/L	GYM25R/LO-H08	5.0	8	45.0	0	73	49.6
C6-GYHER/LM00-M25R/L	GYM25R/LO-H14	5.0	14	45.0	0	79	55.6
C6-GYHER/LM00-M25R/L	GYM25R/LO-H25	5.0	25	45.0	0	90	66.6
C6-GYHER/LM00-M25R/L	GYM25R/LO-J08	6.0	8	45.0	0	73	49.6
C6-GYHER/LM00-M25R/L	GYM25R/LO-J14	6.0	14	45.0	0	79	55.6
C6-GYHER/LM00-M25R/L	GYM25R/LO-J25	6.0	25	45.0	0	90	66.6

\*Stechmodule für Axialeinstiche richten sich nach dem Mindestaxialeinstechdurchmesser. Beispiel: GYM25RD-D12-040

Das Symbol „o“ steht als Platzhalter in der Bezeichnung. Der Platzhalter kann mit „A“ für Außenstechen und „D“ für Axialeinstechen beschrieben werden.

Hinweis 1) Die angegebenen Abmessungen sind Werte für Standard-WSP (GM-Spanbrecher). Wenn andere WSP angebracht sind, können LF und LH abweichen.

F

EINSTECHEN / ABSTECHEN

## ERSATZTEILE

 *		 *									
Bestellbezeichnung	Stk.	Bestellbezeichnung	Stk.	Bestellbezeichnung	Stk.	Bestellbezeichnung	Stk.	Bestellbezeichnung	Bestellbezeichnung		
GY06013M	1	TS55	5	HSD05004S	1	NZ22042080S	1	TKY25D	TKY30R		

\* Spannmoment (N • m) : GY06013M=6.0, TS55=5.0

Düsenwechselschlüssel : NZKH050S

IDENTIFIKATION	> F008, F010
WSP	> F012 – F015
SCHNITTBEDINGUNGEN	> F096, F104
SICHERHEITSHINWEISE	> F100, F106

F091



## GY SERIE (AUSSEN / AXIALEINSTECHEN)

**PSC** 90° Ausführung

**NEW**

Hinweis 1) Bitte das Stechmodul und den modularen Halter getrennt bestellen.  
Hinweis 2) Bitte linkes Stechmodul für den Halter in Rechtsausführung und rechtes Stechmodul für den Halter in Linksausführung zusammenstellen.

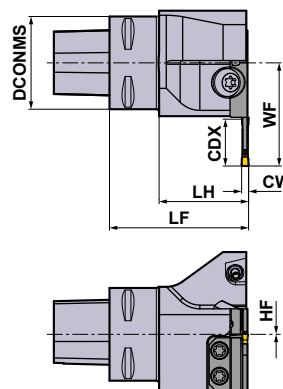

Darstellung von linker Werkzeugaufnahme.

(mm)

Bestellbezeichnung	Lager	Ausführung (R/L)	Kühlmittel	Befestigungsgröße	DCONMS	CW
C4-GYHERM90-M25L	●	R	Aussen	PSC40	40	2.0–6.35
C4-GYHELM90-M25R	●	L	Aussen	PSC40	40	2.0–6.35
C5-GYHERM90-M25L	●	R	Aussen	PSC50	50	2.0–6.35
C5-GYHELM90-M25R	●	L	Aussen	PSC50	50	2.0–6.35
C6-GYHERM90-M25L	●	R	Aussen	PSC60	60	2.0–6.35
C6-GYHELM90-M25R	●	L	Aussen	PSC60	60	2.0–6.35

EINSTECHEN / ABSTECHEN

### Abmaße durch Einsatz von Stechmodulen

Halterausführung	Typ des modularen Schwertes	Standard CW	CDX	WF	HF	LF	LH
C4-GYHER/LM90-M25L/R	GYM25L/R-D06	2.0	6	30.5	0	60	38.6
C4-GYHER/LM90-M25L/R	GYM25L/R-D12	2.0	12	38.5	0	60	38.6
C4-GYHER/LM90-M25L/R	GYM25L/R-D20	2.0	20	44.5	0	60	38.6
C4-GYHER/LM90-M25L/R	GYM25L/R-E06	2.5	6	30.5	0	60	38.6
C4-GYHER/LM90-M25L/R	GYM25L/R-E12	2.5	12	38.5	0	60	38.6
C4-GYHER/LM90-M25L/R	GYM25L/R-E20	2.5	20	44.5	0	60	38.6
C4-GYHER/LM90-M25L/R	GYM25L/R-F06	3.0	6	30.5	0	60	38.6
C4-GYHER/LM90-M25L/R	GYM25L/R-F12	3.0	12	38.5	0	60	38.6
C4-GYHER/LM90-M25L/R	GYM25L/R-F20	3.0	20	44.5	0	60	38.6
C4-GYHER/LM90-M25L/R	GYM25L/R-G08	4.0	8	32.5	0	60	38.6
C4-GYHER/LM90-M25L/R	GYM25L/R-G14	4.0	14	38.5	0	60	38.6
C4-GYHER/LM90-M25L/R	GYM25L/R-G25	4.0	25	49.5	0	60	38.6
C4-GYHER/LM90-M25L/R	GYM25L/R-H08	5.0	8	32.5	0	60	38.6
C4-GYHER/LM90-M25L/R	GYM25L/R-H14	5.0	14	38.5	0	60	38.6
C4-GYHER/LM90-M25L/R	GYM25L/R-H25	5.0	25	49.5	0	60	38.6
C4-GYHER/LM90-M25L/R	GYM25L/R-J08	6.0	8	32.5	0	60	38.6
C4-GYHER/LM90-M25L/R	GYM25L/R-J14	6.0	14	38.5	0	60	38.6
C4-GYHER/LM90-M25L/R	GYM25L/R-J25	6.0	25	49.5	0	60	38.6

\*Stechmodule für Axialeinstiche richten sich nach dem Mindestaxialeinstichdurchmesser. Beispiel: GYM25RD-D12-040

Das Symbol „o“ steht als Platzhalter in der Bezeichnung. Der Platzhalter kann mit „A“ für Außenstechen und „D“ für Axialeinstechen beschrieben werden.

Hinweis 1) Die angegebenen Abmessungen sind Werte für Standard-WSP (GM-Spanbrecher). Wenn andere WSP angebracht sind, können LF und LH abweichen.

● : Lagerstandard.

(mm)

Halteerausführung	Typ des modularen Schwertes	Standard CW	CDX	WF	HF	LF	LH
C5-GYHER/LM90-M25L/R	GYM25L/R-D06	2.0	6	33.0	0	60	38.6
C5-GYHER/LM90-M25L/R	GYM25L/R-D12	2.0	12	41.0	0	60	38.6
C5-GYHER/LM90-M25L/R	GYM25L/R-D20	2.0	20	47.0	0	60	38.6
C5-GYHER/LM90-M25L/R	GYM25L/R-E06	2.5	6	33.0	0	60	38.6
C5-GYHER/LM90-M25L/R	GYM25L/R-E12	2.5	12	41.0	0	60	38.6
C5-GYHER/LM90-M25L/R	GYM25L/R-E20	2.5	20	47.0	0	60	38.6
C5-GYHER/LM90-M25L/R	GYM25L/R-F06	3.0	6	33.0	0	60	38.6
C5-GYHER/LM90-M25L/R	GYM25L/R-F12	3.0	12	41.0	0	60	38.6
C5-GYHER/LM90-M25L/R	GYM25L/R-F20	3.0	20	47.0	0	60	38.6
C5-GYHER/LM90-M25L/R	GYM25L/R-G08	4.0	8	35.0	0	60	38.6
C5-GYHER/LM90-M25L/R	GYM25L/R-G14	4.0	14	41.0	0	60	38.6
C5-GYHER/LM90-M25L/R	GYM25L/R-G25	4.0	25	52.0	0	60	38.6
C5-GYHER/LM90-M25L/R	GYM25L/R-H08	5.0	8	35.0	0	60	38.6
C5-GYHER/LM90-M25L/R	GYM25L/R-H14	5.0	14	41.0	0	60	38.6
C5-GYHER/LM90-M25L/R	GYM25L/R-H25	5.0	25	52.0	0	60	38.6
C5-GYHER/LM90-M25L/R	GYM25L/R-J08	6.0	8	35.0	0	60	38.6
C5-GYHER/LM90-M25L/R	GYM25L/R-J14	6.0	14	41.0	0	60	38.6
C5-GYHER/LM90-M25L/R	GYM25L/R-J25	6.0	25	52.0	0	60	38.6
C6-GYHER/LM90-M25L/R	GYM25L/R-D06	2.0	6	40.0	0	70	46.6
C6-GYHER/LM90-M25L/R	GYM25L/R-D12	2.0	12	48.0	0	70	46.6
C6-GYHER/LM90-M25L/R	GYM25L/R-D20	2.0	20	54.0	0	70	46.6
C6-GYHER/LM90-M25L/R	GYM25L/R-E06	2.5	6	40.0	0	70	46.6
C6-GYHER/LM90-M25L/R	GYM25L/R-E12	2.5	12	48.0	0	70	46.6
C6-GYHER/LM90-M25L/R	GYM25L/R-E20	2.5	20	54.0	0	70	46.6
C6-GYHER/LM90-M25L/R	GYM25L/R-F06	3.0	6	40.0	0	70	46.6
C6-GYHER/LM90-M25L/R	GYM25L/R-F12	3.0	12	48.0	0	70	46.6
C6-GYHER/LM90-M25L/R	GYM25L/R-F20	3.0	20	54.0	0	70	46.6
C6-GYHER/LM90-M25L/R	GYM25L/R-G08	4.0	8	42.0	0	70	46.6
C6-GYHER/LM90-M25L/R	GYM25L/R-G14	4.0	14	48.0	0	70	46.6
C6-GYHER/LM90-M25L/R	GYM25L/R-G25	4.0	25	59.0	0	70	46.6
C6-GYHER/LM90-M25L/R	GYM25L/R-H08	5.0	8	42.0	0	70	46.6
C6-GYHER/LM90-M25L/R	GYM25L/R-H14	5.0	14	48.0	0	70	46.6
C6-GYHER/LM90-M25L/R	GYM25L/R-H25	5.0	25	59.0	0	70	46.6
C6-GYHER/LM90-M25L/R	GYM25L/R-J08	6.0	8	42.0	0	70	46.6
C6-GYHER/LM90-M25L/R	GYM25L/R-J14	6.0	14	48.0	0	70	46.6
C6-GYHER/LM90-M25L/R	GYM25L/R-J25	6.0	25	59.0	0	70	46.6

\*Stechmodule für Axialeinstiche richten sich nach dem Mindestaxialeinstechdurchmesser. Beispiel: GYM25RD-D12-040

Das Symbol „o“ steht als Platzhalter in der Bezeichnung. Der Platzhalter kann mit „A“ für Außenstechen und „D“ für Axialeinstechen beschrieben werden.

Hinweis 1) Die angegebenen Abmessungen sind Werte für Standard-WSP (GM-Spanbrecher). Wenn andere WSP angebracht sind, können LF und LH abweichen.

F

EINSTECHEN / ABSTECHEN

## ERSATZTEILE

											
Bestellbezeichnung	Stk.	Bestellbezeichnung	Stk.	Bestellbezeichnung	Stk.	Bestellbezeichnung	Stk.	Bestellbezeichnung	Bestellbezeichnung		
GY06013M	1	TS55	5	HSD05004S	1	NZ22042080S	1	TKY25D	TKY30R		

\* Spannmoment (N • m) : GY06013M=6.0, TS55=5.0

Düsenwechselschlüssel : NZKH050S

IDENTIFIKATION	> F008, F010
WSP	> F012 – F015
SCHNITTBEDINGUNGEN	> F096, F104
SICHERHEITSHINWEISE	> F100, F106

## GY SERIE (ZUM FREISTECHEN)

**PSC**

Für 50°-Einstechhalter

**NEW**

Hinweis 1) Bitte Stechmodul und modularen Halter getrennt bestellen.

Hinweis 2) Bitte Stechmodul in Linksausführung für Halter in Rechtsausführung und Stechmodul in Rechtsausführung für Halter in Linksausführung einstellen.

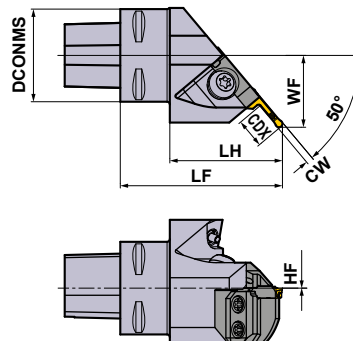

Darstellung von linker Werkzeugaufnahme.

(mm)

Bestellbezeichnung	Lager	Ausführung (R/L)	Kühlmittel	Befestigungsgröße	DCONMS	CW
C4-GYHERM50-M25L	●	R	Aussen	PSC40	40	2.0–6.35
C4-GYHELM50-M25R	●	L	Aussen	PSC40	40	2.0–6.35
C5-GYHERM50-M25L	●	R	Aussen	PSC50	50	2.0–6.35
C5-GYHELM50-M25R	●	L	Aussen	PSC50	50	2.0–6.35
C6-GYHERM50-M25L	●	R	Aussen	PSC60	60	2.0–6.35
C6-GYHELM50-M25R	●	L	Aussen	PSC60	60	2.0–6.35

EINSTECHEN / ABSTECHEN

### ERSATZTEILE

Bestellbezeichnung	Stk.	Bestellbezeichnung	Stk.	Bestellbezeichnung	Stk.	Bestellbezeichnung	Stk.	Bestellbezeichnung	Bestellbezeichnung	
GY06013M	1	TS55	4	HSD05004S	1	NZ22042080S	1	TKY25D	TKY30R	

\* Spannmoment (N • m) : GY06013M=6.0, TS55=5.0

Düsenwechselschlüssel : NZKH050S

● : Lagerstandard.

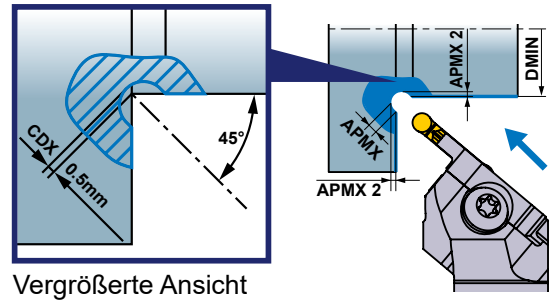

Vergrößerte Ansicht

### Abmaße durch Einsatz von Stechmodulen

(mm)

Halteausführung	Typ des modularen Schwertes	Standard CW	CDX	DMIN	APMX	APMX2	WF	HF	LF	LH
C4-GYHER/LM50-M25L/R	GYM25L/RC-D005	2.0	0.5	30	1.50	0.646	30.6	0	70.2	48.8
C4-GYHER/LM50-M25L/R	GYM25L/RC-E005	2.5	0.5	30	1.75	0.720	30.8	0	70.1	48.7
C4-GYHER/LM50-M25L/R	GYM25L/RC-F005	3.0	0.5	30	2.00	0.793	31.0	0	70.0	48.6
C4-GYHER/LM50-M25L/R	GYM25L/RC-G005	4.0	0.5	20	2.50	0.939	31.4	0	69.8	48.4
C4-GYHER/LM50-M25L/R	GYM25L/RC-H005	5.0	0.5	20	2.88	1.049	31.8	0	69.6	48.2
C4-GYHER/LM50-M25L/R	GYM25L/RC-J005	6.0	0.5	20	3.50	1.232	32.4	0	69.4	48.0
C5-GYHER/LM50-M25L/R	GYM25L/RC-D005	2.0	0.5	30	1.50	0.646	32.6	0	70.2	48.8
C5-GYHER/LM50-M25L/R	GYM25L/RC-E005	2.5	0.5	30	1.75	0.720	32.8	0	70.1	48.7
C5-GYHER/LM50-M25L/R	GYM25L/RC-F005	3.0	0.5	30	2.00	0.793	33.0	0	70.0	48.6
C5-GYHER/LM50-M25L/R	GYM25L/RC-G005	4.0	0.5	20	2.50	0.939	33.4	0	69.8	48.4
C5-GYHER/LM50-M25L/R	GYM25L/RC-H005	5.0	0.5	20	2.88	1.049	33.8	0	69.6	48.2
C5-GYHER/LM50-M25L/R	GYM25L/RC-J005	6.0	0.5	20	3.50	1.232	34.4	0	69.4	48.0
C6-GYHER/LM50-M25L/R	GYM25L/RC-D005	2.0	0.5	30	1.50	0.646	39.6	0	70.2	46.8
C6-GYHER/LM50-M25L/R	GYM25L/RC-E005	2.5	0.5	30	1.75	0.720	39.8	0	70.1	46.7
C6-GYHER/LM50-M25L/R	GYM25L/RC-F005	3.0	0.5	30	2.00	0.793	40.0	0	70.0	46.6
C6-GYHER/LM50-M25L/R	GYM25L/RC-G005	4.0	0.5	20	2.50	0.939	40.4	0	69.8	46.4
C6-GYHER/LM50-M25L/R	GYM25L/RC-H005	5.0	0.5	20	2.88	1.049	40.8	0	69.6	46.2
C6-GYHER/LM50-M25L/R	GYM25L/RC-J005	6.0	0.5	20	3.50	1.232	41.4	0	69.4	46.0

DMIN = Min. Stechdurchmesser

\*Stechmodule für Axialeinstiche richten sich nach dem Mindestaxialeinstechdurchmesser. Beispiel: GYM25RD-D12-040  
Das Symbol „“ steht als Platzhalter in der Bezeichnung. Der Platzhalter kann mit „A“ für Außenstechen und „D“ für Axialeinstechen beschreiben werden.

Hinweis 1) Die angegebenen Abmessungen sind Werte für Standard-WSP (GM-Spanbrecher). Wenn andere WSP angebracht sind, können LF und LH abweichen.

F

EINSTECHEN / ABSTECHEN

IDENTIFIKATION	> F008, F010
WSP	> F015
SCHNITTBEDINGUNGEN	> F099
SICHERHEITSHINWEISE	> F099

F095

# EINSTECHEN / ABSTECHEN

## EMPFOHLENE SCHNITTGESCHWINDIGKEIT [Aussenbearbeitung / Abstechen]

Werkstoff	Härte	Sorte	Schnittgeschwindigkeit (m/min)							
			50	100	150	200	250	300	500	
P Baustahl	≤160HB	VP20RT		100		220				
		VP10RT		110		230				
		NX2525		90		210				
	C-Stahl Legierter Stahl	160–280HB	VP20RT		80		180			
			VP10RT		90		190			
			MY5015		110		250			
		280HB≤	NX2525		70		170			
			VP20RT		60		140			
			VP10RT		70		150			
Rostfreier Stahl	≤270HB	MY5015		90		210				
		NX2525		55		135				
		VP20RT		60		140				
K Grauguss	Zugfestigkeit ≤300MPa	VP20RT		80		180				
		VP10RT		90		180				
		MY5015		140		300				
	Duktiles Gusseisen	Zugfestigkeit ≤800MPa	VP20RT		60		140			
			VP10RT		70		150			
			MY5015		90		210			
S Hitzebeständige Legierung Titanlegierung	–	MP9015		40		100				
		MP9025		30		90				
		VP20RT		30		60				
		VP10RT/ RT9010		40		70				
H Gehärteter Stahl	50HRC≤	BC8110		80		120				
N Aluminiumleg.	Inhalt Si<5%	RT9010					200		500	
							200		500	
	Inhalt 5% ≤ - Si ≤ 10%	RT9010					200		500	
Aluminiumleg.	Inhalt Si>10%	RT9010		100		200				

Hinweis 1) Für RT9010, VP10RT, VP20RT und MY5015 wird der Einsatz von Kühlschmierstoff empfohlen.

# SCHNITTBEDINGUNGEN [Außenbearbeitung / Abstechen]

\*Die unten aufgeführten empfohlenen Schnittdaten beziehen sich auf die Verwendung des modularen Halters GYHR/L2525M00/90-M25R/L mit dem modularen Schwert GYM25R/LA-○○○.

## Empfohlene Vorschübe

### GU-Spanbrecher

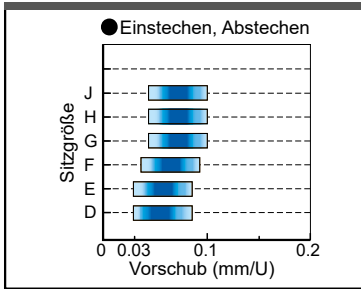

### GS-Spanbrecher

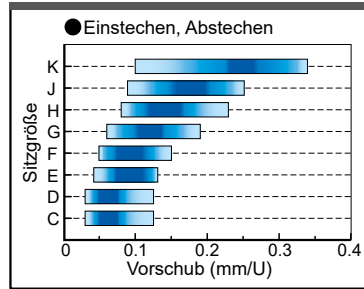

■ : Erster empfohlener Bereich

Sitzgröße			
	WSP-Stechbreite (mm)		WSP-Stechbreite (mm)
C	1.50	G	4.00
			4.24
D	2.00	H	4.75
	2.24		5.00
E	2.39	J	6.00
	2.50		6.31
	2.74		6.35
F	3.00	K	8.00
	3.18		
	3.24		

### GM-Spanbrecher

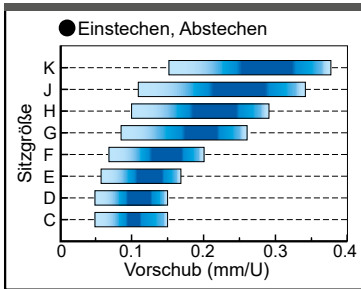

### GL-Spanbrecher

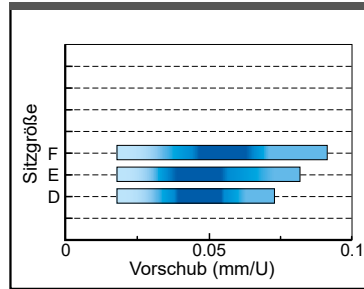

### Plan GFGS (CBN)

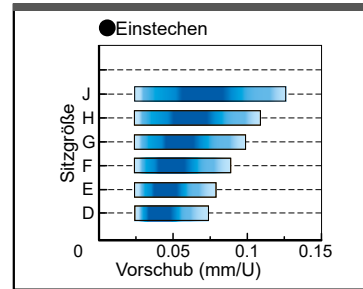

### MF-Spanbrecher

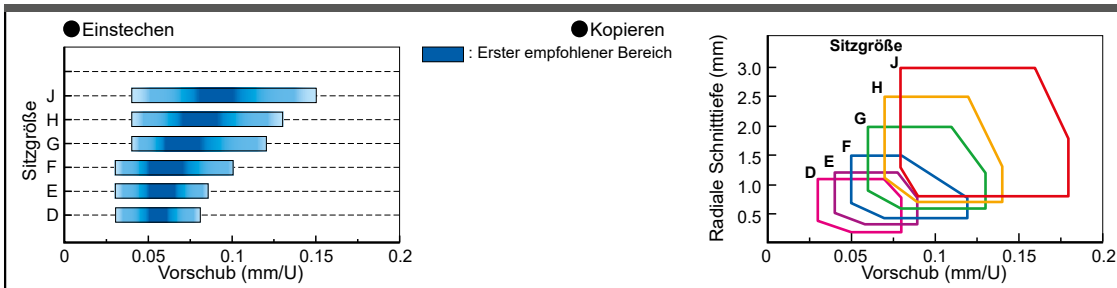

### MS-Spanbrecher

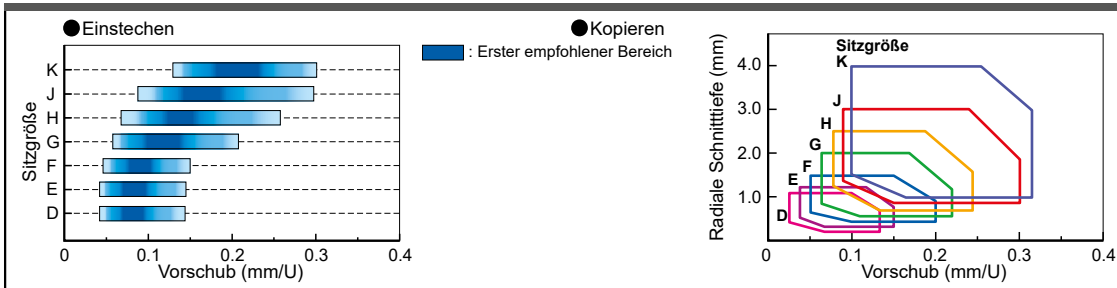

### MM-Spanbrecher

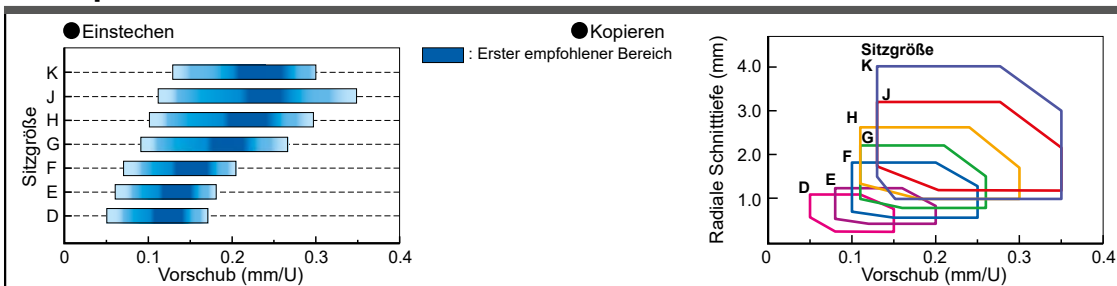

## Empfohlene Vorschübe

### BM-Spanbrecher

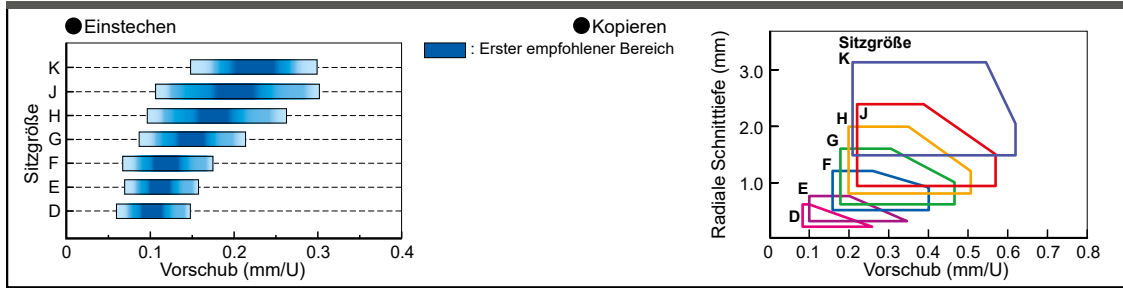

Sitzgröße	
WSP-Stechbreite (mm)	
C	1.50
D	2.00
	2.24
E	2.39
	2.50
	2.74
F	3.00
	3.18
	3.24
G	4.00
	4.24
H	4.75
	5.00
	5.24
J	6.00
	6.31
	6.35
K	8.00

Hinweis 1) Bei Einsatz der unten gezeigten Kombination ist die empfohlene Vorschubgeschwindigkeit um 20% bzw. 40% zu reduzieren.

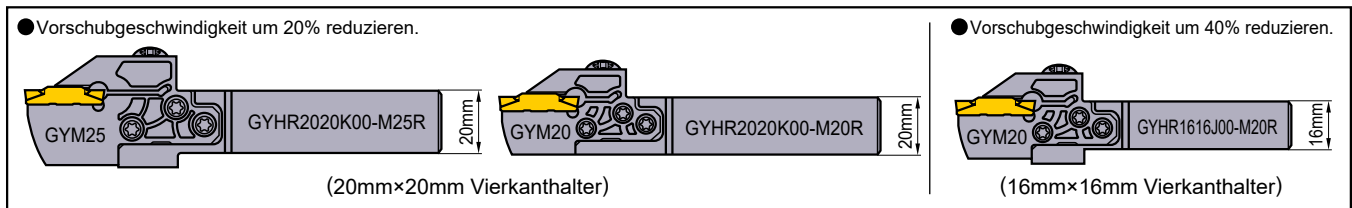

### Bei Monoblock Haltern für Swiss-Langdrehautomaten

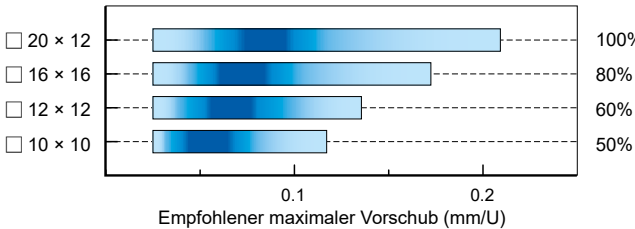

Die empfohlenen Schnittbedingungen für das Außeneinsteichen und Abstechen entnehmen Sie bitte aus den obigen Tabellen. Wenden Sie das für jede Schaftgröße angegebene prozentuale Verhältnis mit den Werten in der Tabelle an.

## BEGRENZUNG DER MAXIMALEN SCHNITTtiefe [Außenbearbeitung]

● Bei Verwendung des modularen Schwertes GYM<sup>OR</sup>/LA<sup>OR</sup>  
Die maximale Schnitttiefe wird nicht durch den Durchmesser des Werkstücks begrenzt.

● Bei Verwendung des modularen Schwertes GYM<sup>OR</sup>/LB<sup>OR</sup>  
Die maximale Schnitttiefe wird durch den Durchmesser des Werkstücks begrenzt.

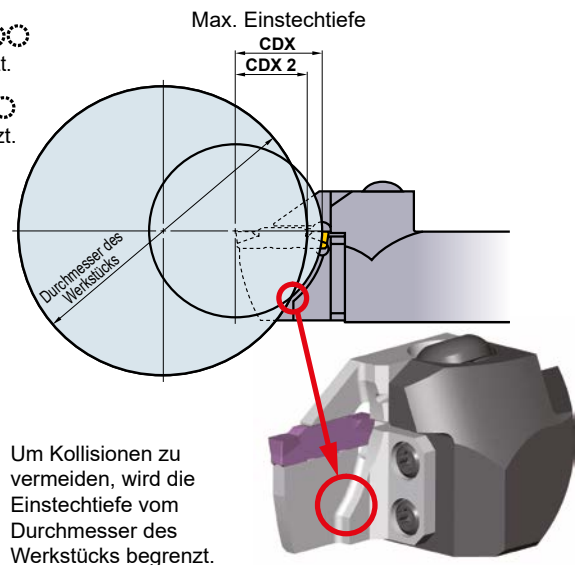
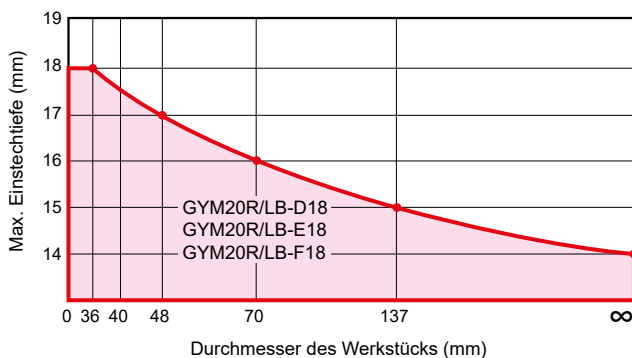



# EMPFOHLENE SCHNITTGESCHWINDIGKEIT (m/min) [Externes Freistechen]

Werkstoff	Härte	Sorte	Schnittgeschwindigkeit (m/min)					
			50	100	150	200	250	
P	Baustahl	VP20RT	80 — 180					
		VP10RT	90 — 190					
	C-Stahl Legierter Stahl	VP20RT	60 — 140					
		VP10RT	70 — 150					
		MY5015	90 — 210					
		NX2525	55 — 135					
	C-Stahl Legierter Stahl	VP20RT	50 — 110					
		VP10RT	60 — 120					
		MY5015	80 — 160					
		NX2525	45 — 105					
	M	Rostfreier Stahl	VP20RT	50 — 110				
			VP10RT	60 — 120				
K	Grauguss	VP20RT	60 — 140					
		VP10RT	70 — 150					
		MY5015	90 — 210					
	Duktiler Guss	VP20RT	50 — 110					
		VP10RT	60 — 120					
		MY5015	80 — 160					
S	Titanlegierung Hitzebeständige Legierung	MP9015	40 — 100					
		MP9025	30 — 90					
		VP20RT	30 — 60					
		VP10RT	40 — 70					

Hinweis 1) Für VP10RT, VP20RT und MY5015 wird Nasszerspanung empfohlen.

## ABSTAND DES WERKSTÜCKS ZUM EINSTICH

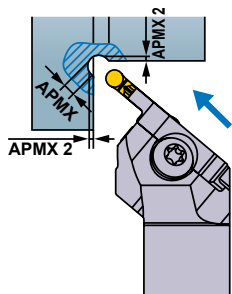

Einstechbreite CW (mm)	Stechtiefe APMX (mm)	Abstand Werkstück zum Einstich APMX 2 (mm)
2.00	1.50	0.646
2.50	1.75	0.720
3.00	2.00	0.793
3.18	2.09	0.819
4.00	2.50	0.939
4.75	2.88	1.049
5.00	3.00	1.086
6.00	3.50	1.232
6.35	3.68	1.283

## BM-SPANBRECHER

### Minimaler Einstechdurchmesser

Stellen Sie sicher, dass das Werkzeug für den Durchmesser geeignet ist. Siehe Min. Einstechdurchmesser DMIN wie in der Tabelle auf Seite F036 angegeben, um eine Kollision mit dem Werkstück wie unten angezeigt zu verhindern.

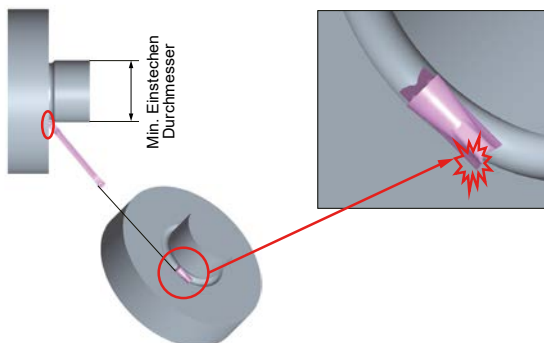

### Empfohlene Vorschubgeschwindigkeit und Schnitttiefe

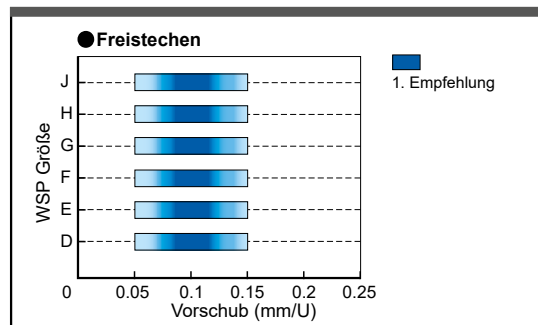

## WERKZEUGAUSWAHL

### Hinweise zur Auswahl der Werkzeughalter

#### Modularer Halter

● Modularen Halter mit größtmöglichem Schaft auswählen, um ausreichende Klemmfestigkeit sicherzustellen.

#### Modulares Schwert (1)

● Wenn keine Einschränkungen vorliegen, wählen Sie bitte das längste modulare Schwert für die gleiche Schaftgröße aus.

#### Modulares Schwert (2)

● Wählen Sie das kürzeste Schwert aus, das für die Anwendung geeignet ist.

#### Modulares Schwert (3)

● Wählen Sie das kürzeste Schwert aus, das für die Anwendung geeignet ist.

### Hinweise zum Einsetzen des Werkzeuges

#### Einstellen der Schneidkantenhöhe

<Einstech-/Längsdrehbearbeitung>  
Schnittkantenhöhe auf  $\pm 0.1\text{mm}$  parallel zur Mittelachse einstellen.

<Abstechen>  
Schnittkantenhöhe auf  $0\text{--}+0.2\text{mm}$  parallel zur Mittelachse einstellen.

#### Einstellen des Zustellwinkels

● Schneidplatte senkrecht zur Mittelachse positionieren.

#### Auskragung

● Achten Sie beim Einstellen des Werkzeuges darauf, dass die Auskragung so kurz wie möglich ist, und vermeiden Sie, dass der Werkzeughalter mit der Klemmvorrichtung in Berührung kommt, wie in der obigen Abbildung gezeigt.

# BEARBEITUNGSEMPFEHLUNGEN

## Hinweise zur multifunktionalen Bearbeitung (MF, MS- und MM-Spanbrecher)

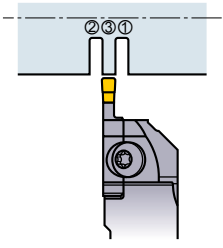
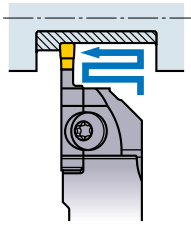
<h3>Bearbeitung enger Nuten</h3>  <p>●Es wird empfohlen in mehreren Durchgängen einzutauchen. Dies hilft auch die Präzision des Werkstückes zu verbessern und einen Spänestau zu verhindern.</p>	<h3>Bearbeitung breiter Nuten</h3>  <p>●Es wird empfohlen, die Bearbeitung von breiten Nuten mit Stechdrehen durchzuführen.</p>
---	--

### Bearbeitung breiter Nuten

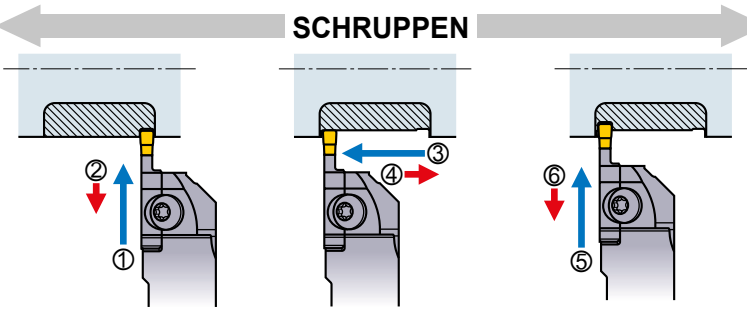
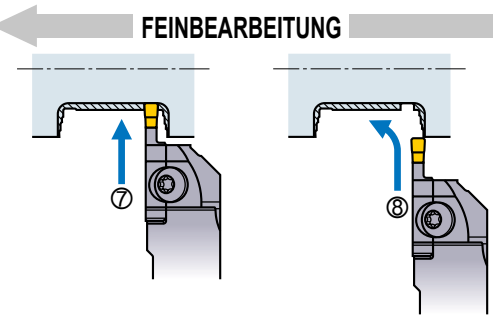
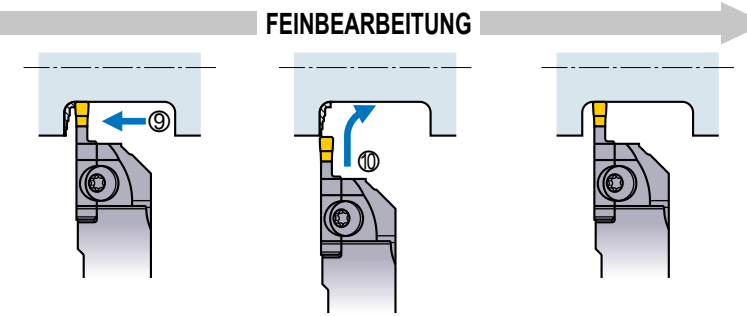
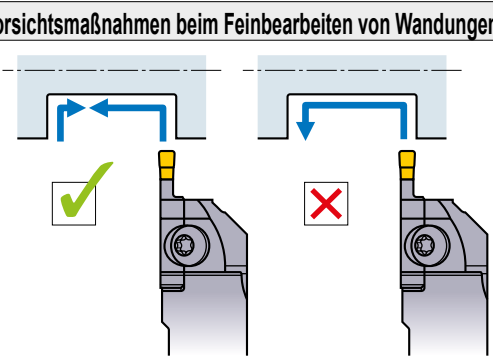
<h4 style="text-align: center;">SCHRUPPEN</h4>  <p>①Einstecken ②Werkzeug um ca. 0.1mm herausziehen. ③Längsdrehbearbeitung durchführen. ④Werkzeug um ca. 0.1mm herausziehen. ⑤Einstecken ⑥Werkzeug um ca. 0.1mm herausziehen. * Schritte ①–⑥ wiederholen.</p>	<h4 style="text-align: center;">FEINBEARBEITUNG</h4>  <p>⑦Einstecken bis zum Ende des Eckenradius ausführen. ⑧Die Bearbeitung der Planfläche und der Konturen sollte in einem Arbeitsgang erfolgen.</p>
<h4 style="text-align: center;">FEINBEARBEITUNG</h4>  <p>⑨Halten Sie am unteren Ende des Eckenradius an. ⑩Bearbeiten Sie die dem Eckenradius gegenüberliegende Wand in einem Arbeitsgang. ⑪Beenden Sie die Bearbeitung.</p>	<h4 style="text-align: center;">Vorsichtsmaßnahmen beim Feinbearbeiten von Wandungen</h4>  <p>●Zum Herstellen von Präzisionswänden mit der Schneidplatte eines MS- oder MM-Spanbrechers nicht die Richtung umkehren. Empfohlen wird Eintauchen.</p>

EINSTECHEN / ABSTECHEN

### Bearbeitung von Wandungen

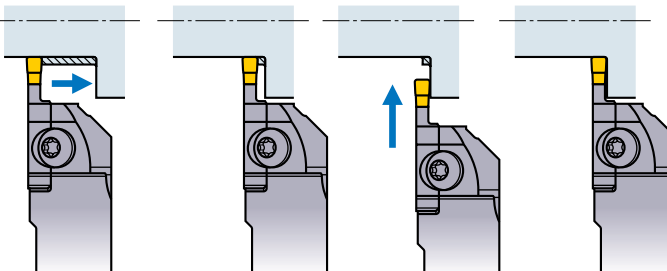

●Beim Bearbeiten von Schultern kann an Wandungen der Späneablauf ungünstig beeinflusst werden. Dies kann zu Spanstau und Plattenbruch führen. In diesem Fall die Längsbearbeitung kurz vor der Wandung beenden und durch erneutes Einstechen fertig bearbeiten.

### Bearbeitung an Nutflanken

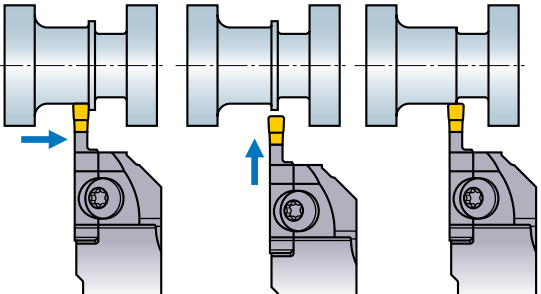

●Beim Bearbeiten von Flächen in der Nähe von Ringen kann der Späneablauf ungünstig beeinflusst werden. Wir empfehlen, die Bearbeitung 1–1.5mm vor dem Ring zu beenden und den Ring durch Einstechen/Eintauchen zu entfernen.

## BEARBEITUNGSEMPFEHLUNGEN

### Hinweise für multifunktionale Bearbeitung (BM-Spanbrecher)

#### Kopierdrehen

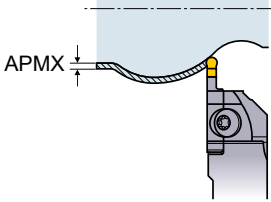

● Mit der Schneidplatte des BM-Spanbrechers ist 3D-Kopieren möglich. Die Schnitttiefe (APMX) auf 40% der WSP-Breite einstellen.

#### Schruppen

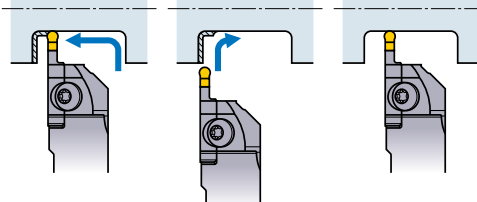

● Eintauchen und Längsdrehen wird empfohlen. Den Vorschub um 50% reduzieren, um die beim Bearbeiten der Ecken möglichen Vibrationen zu dämpfen.

### Feinbearbeitung

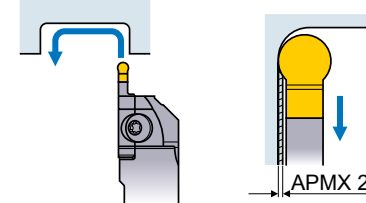

● Die Feinbearbeitung in einem Vorgang ausführen. Die Schnitttiefe (APMX 2) beim Ausstechen entnehmen Sie bitte der Tabelle.

WSP	APMX 2 (mm)
GY2M0200D100N-BM	0.05
GY2M0250E125N-BM	0.10
GY2M0300F150N-BM	0.15
GY2M0318F159N-BM	
GY2M0400G200N-BM	0.20
GY2M0475H238N-BM	
GY2M0500H250N-BM	0.24
GY2M0600J300N-BM	
GY2M0635J318N-BM	0.30
GY2M0800K400N-BM	
	0.40

### Hinweise zum Abstechen

#### Vorschub

<Vorschub>

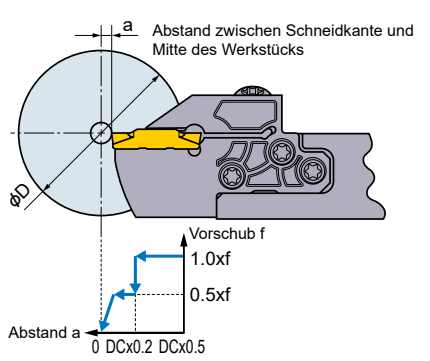

● Den Vorschub um 50% reduzieren, wenn die Schneidkante sich der Mitte nähert.

● Den Vorschub ggf. vor Erreichen der Werkstückmitte ausschalten, damit das Werkstück nicht unter seinem Eigengewicht einfällt.

#### Drehzahl

<Drehzahl>

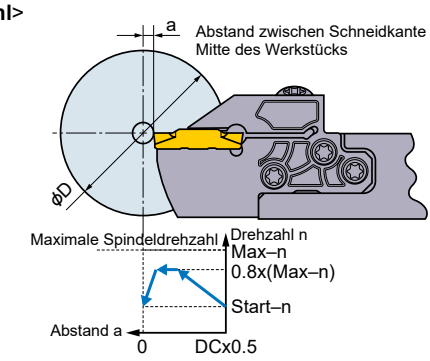

● Bei konstanter Schnittgeschwindigkeit während eines Abstechzyklus wird empfohlen, die Spindeldrehzahl auf 80% des Maximums einzustellen, um die Stabilität sicherzustellen.

● Die Spindeldrehzahl vor Beenden des Einstechvorgangs reduzieren, um ein Wegschleudern des Werkstücks zu verhindern.

### WSP

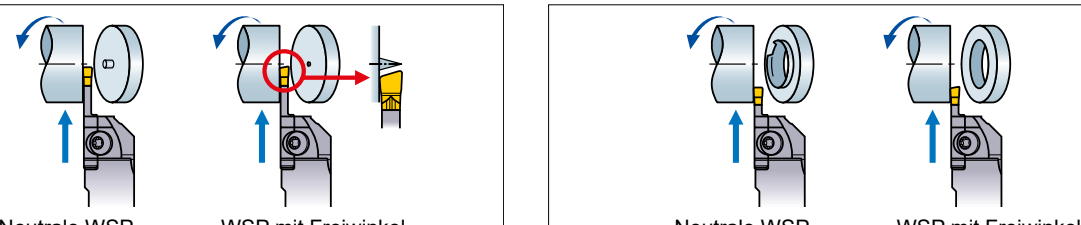

● Mittelstützen oder Grate am Werkstück können mit Hilfe einer WSP in Links-/Rechtsausführung reduziert werden. Die Bearbeitung mit einer WSP in Links-/Rechtsausführung neigt im Vergleich zu einer neutralen WSP eher zu Instabilität. Es sind insbesondere Brüche der Schneidkante zu vermeiden und bei Bedarf die Vorschubgeschwindigkeit zu reduzieren.

# Notizen

---

A series of horizontal dashed lines for writing notes, spanning the width of the page.

# EINSTECHEN / ABSTECHEN

## ZUSAMMENHANG VON VORSCHUB UND MODULAREN SCHWERTERN [Für axiales Einstechen]

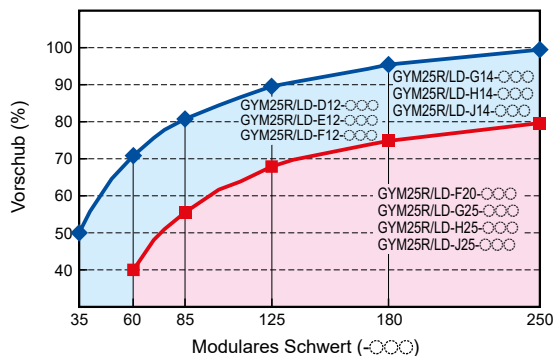

Hinweis 1) Stellen Sie den Vorschub je Umdrehung gemäß der oben gezeigten Tabelle in % ein.

## EMPFOHLENE SCHNITTGESCHWINDIGKEIT [Für axiales Einstechen]

Werkstoff	Härte	Sorte	Schnittgeschwindigkeit (m/min)							
			50	100	150	200	250	300		
P Baustahl  C-Stahl Legierter Stahl	≤160HB	VP20RT		80		180				
		VP10RT		90		190				
		NX2525		70		170				
	160–280HB	VP20RT		60		140				
		VP10RT		70		150				
		MY5015		90		210				
		NX2525		55		135				
		280HB≤	VP20RT		50		110			
			VP10RT		60		120			
			MY5015		80		160			
NX2525			45		105					
M Rostfreier Stahl	≤270HB	VP20RT		50		110				
		VP10RT		60		120				
K Grauguss  Duktiles Gusseisen	Zugfestigkeit ≤300MPa	VP20RT		60		140				
		VP10RT		70		150				
		MY5015		90		210				
	Zugfestigkeit ≤800MPa	VP20RT		50		110				
		VP10RT		60		120				
		MY5015		80		160				
S Hitzebeständige Legierung Titanlegierung	-	MP9015		40		100				
		MP9025		30		90				
		VP20RT		30		60				
		VP10RT		40		70				
		RT9010		40		70				
H Gehärteter Stahl	50HRC≤	BC8110		60		120				

Hinweis 1) Für VP10RT, VP20RT und MY5015 wird der Einsatz von Kühlschmierstoff empfohlen.

# SCHNITTDATENEMPFEHLUNG [Für axiales Einstechen]

## AXIAL EINSTECHEN

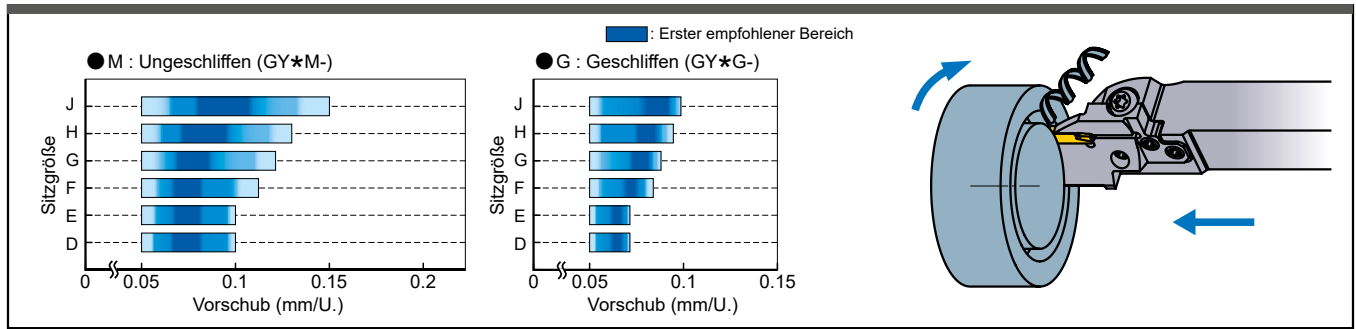

## AXIAL STECHEN

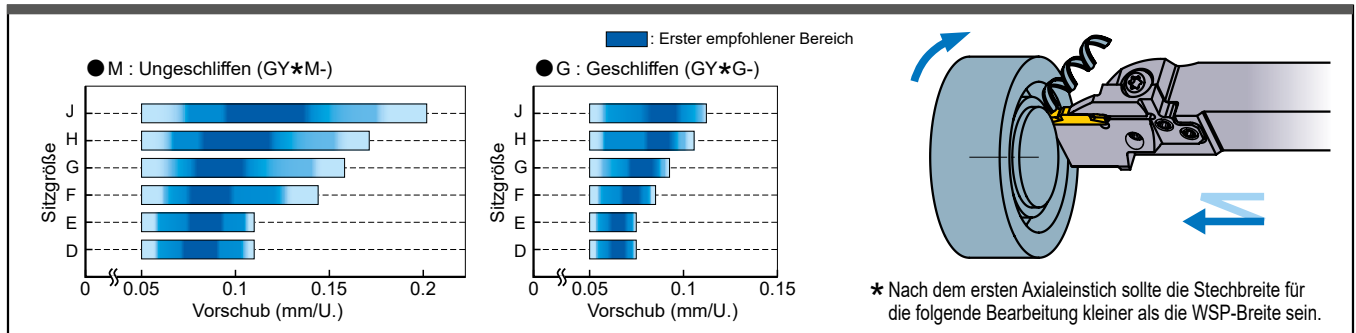

## PLAN- UND KOPIERDREHEN (MF-SPANBRECHER)

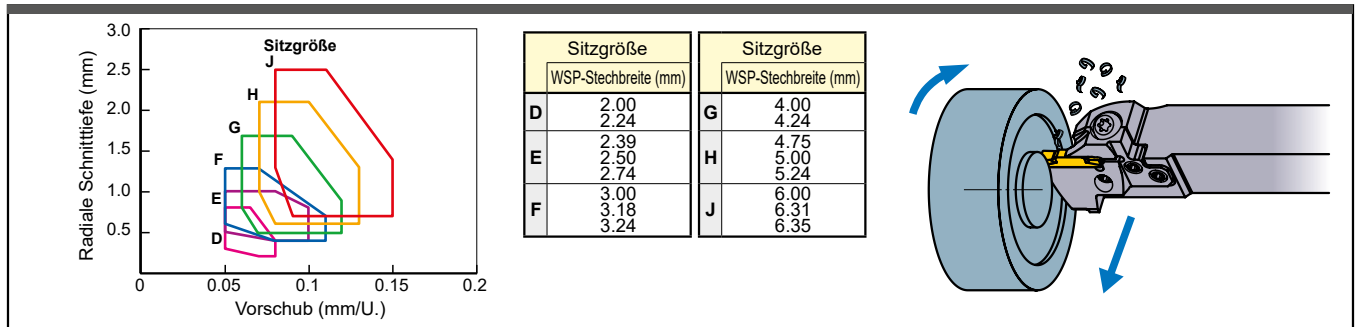

## PLANDREHEN (MM/MS SPANBRECHER)

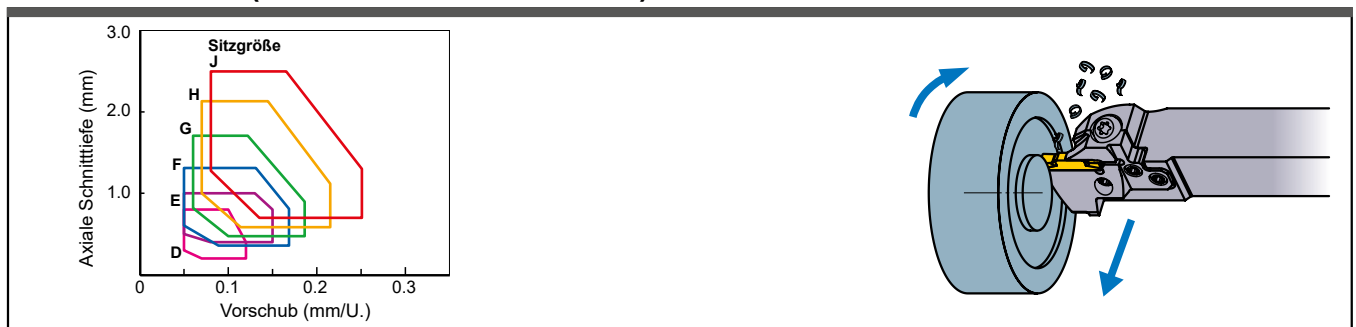

## PLAN- UND KOPIERDREHEN (BM-SPANBRECHER)

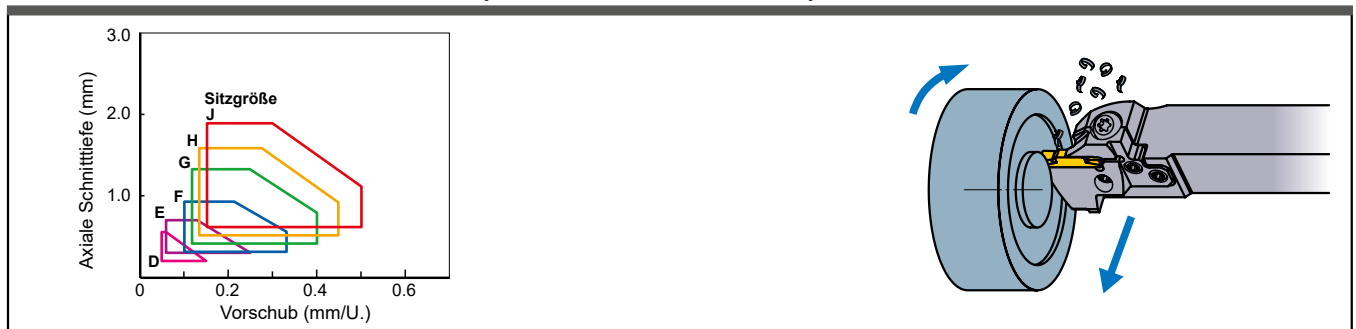

EINSTECHEN / ABSTECHEN



## WERKZEUGAUSWAHL

### Hinweise zur Auswahl der Werkzeughalter

#### Modulares Schwert (1)

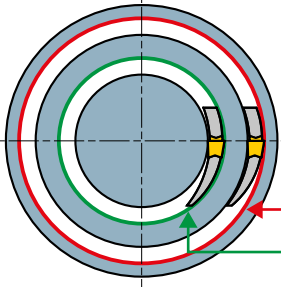

- Wählen Sie ein modulares Schwert, bei dem der Durchmesser für den ersten Einstich innerhalb des Durchmesserbereichs DAXN Min. und DAXX Max. liegt, wie in den Tabellen angegeben wird.

#### Modulares Schwert (2)

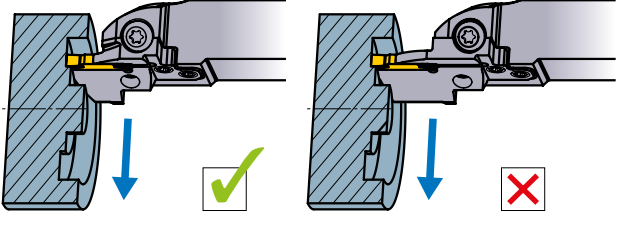

- Wählen Sie das kürzeste Schwert aus, das für die Anwendung geeignet ist.

#### Modulares Schwert (3)

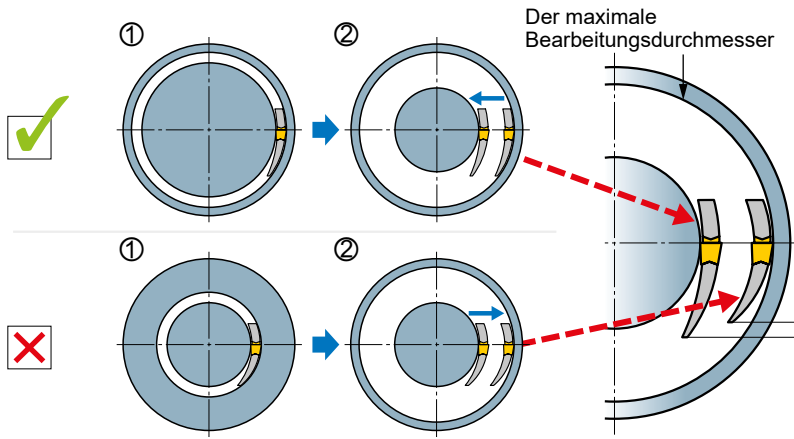

Der maximale Bearbeitungsdurchmesser

- Wählen Sie das größte Schwert aus, das innerhalb des maximalen Bearbeitungsdurchmessers liegt.
- Bearbeiten Sie das Werkstück von aussen nach innen.

↓

- Durch die hohe Stabilität des modularen Schwertes erzielen Sie eine verbesserte Stabilität und eine höhere Prozesssicherheit.

Beginnen Sie das Einstechen von außen nach innen, dadurch gibt es keine Einschränkungen für den min. Bearbeitungsdurchmesser.

● Beim Mehrfach-Axialeinstechen.

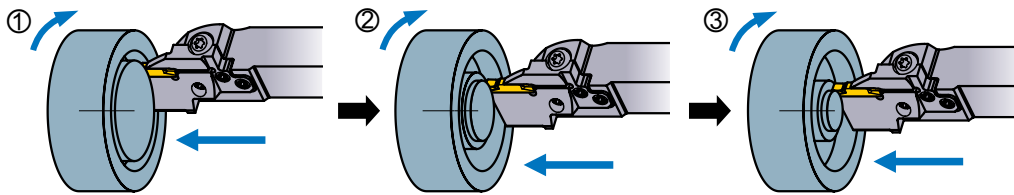

● Bei der Kombination von Axialeinstechen mit Stechdrehen.

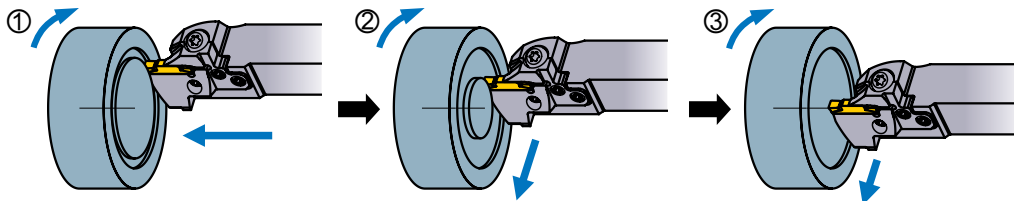

#### Modularer Halter

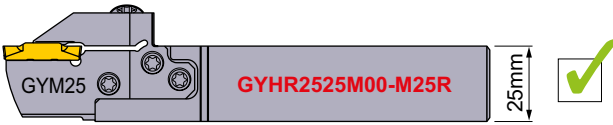

Modularer Halter

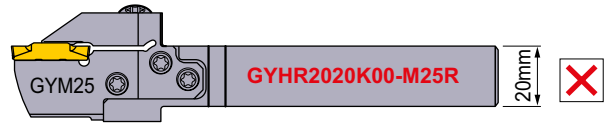

Modularer Halter

Modularen Halter mit größtmöglichem Schaftquerschnitt auswählen, um die Stabilität zur Aufspannung beizubehalten.

## Hinweise zum Einsetzen des Werkzeuges

### Einstellen der Schneidkantenhöhe

- Schnittkantenhöhe auf  $\pm 0.1\text{mm}$  parallel zur Mittelachse einstellen.
- Überprüfen Sie die Einstellung des Werkzeuges (Schnittkantenhöhe) beim Stech- und Plandrehen von außen nach innen speziell bei kleinen Schnitttiefen um sicherzustellen, dass im Zentrum kein Restmaterial vorhanden ist.

### Wenn das modulare Schwert an der Nut schabt

- Wenn die Innen- oder Außenseite des Schwertes am Werkstück schabt, kann eine falsche Schneidkantenhöhe vorliegen.
  - Wenn die Innenseite am Werkstück schabt, senken Sie das Werkzeug leicht unter die Mittenlinie und stellen Sie sicher, dass das Werkzeug parallel zur Rotationsachse steht.
  - Wenn die Außenseite am Werkstück schabt, heben Sie das Werkzeug leicht über die Mittenlinie und stellen Sie sicher, dass das Werkzeug parallel zur Rotationsachse steht.

### Werkzeugzustellung

- Schneidkante parallel zur Rotationsachse positionieren.

### Auskragung

- Achten Sie beim Einstellen des Werkzeuges darauf, dass die Auskragung so kurz wie möglich ist, und vermeiden Sie, dass der Werkzeughalter mit der Klemmvorrichtung in Berührung kommt, wie in der obigen Abbildung gezeigt.

## BEARBEITUNGSEMPFEHLUNGEN

### Hinweis für Axialeinstechen

- Bearbeiten Sie das Werkstück von außen nach innen.

#### Bearbeitung enger Nuten

- Mehrfach-Axialeinstechen wird empfohlen, wenn die Nut tiefer als sie breit ist.

#### Bearbeitung breiter Nuten

- Stechdrehen wird bei Nuten empfohlen, die breiter sind als sie tief sind.

## BEARBEITUNGSEMPFEHLUNGEN

### Hinweis für Axialeinstechen

#### Hinweise zum ersten Einstich (1)

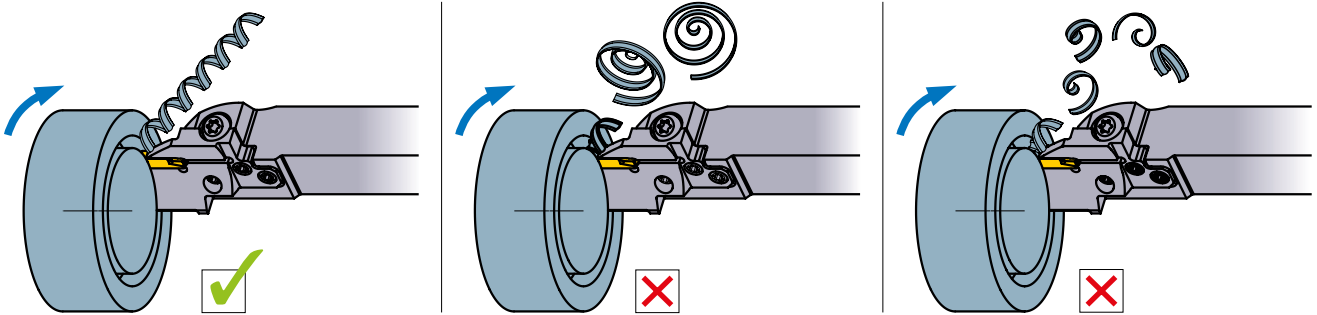

- Beim ersten Axialeinstich ist es schwierig, einen Spanbruch zu erzeugen. Dies kann zu vorzeitigem Schneidkantenbruch führen. Bei langen Spänen reduzieren Sie einfach den Vorschub.

#### Hinweise zum ersten Einstich (2)

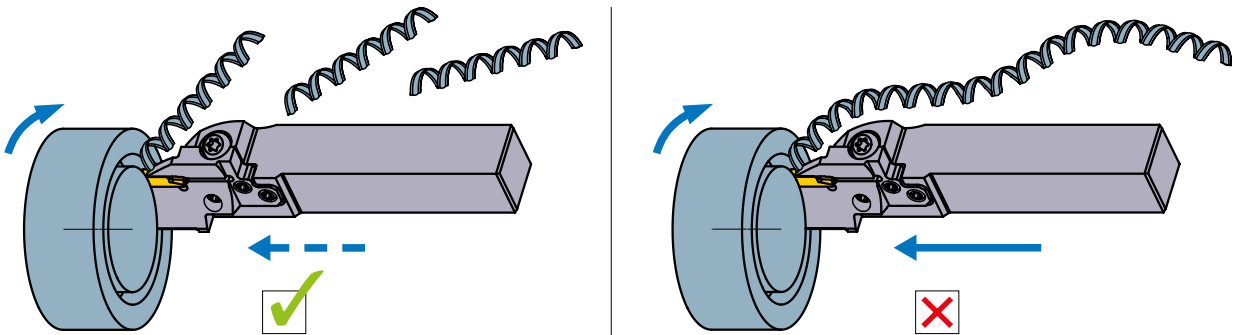

- Wenn die Späne zu lang werden, sollten Vorschubstopps programmiert werden, um die Späne zu brechen.

#### Hinweise für Mehrfach-Axialeinstechen

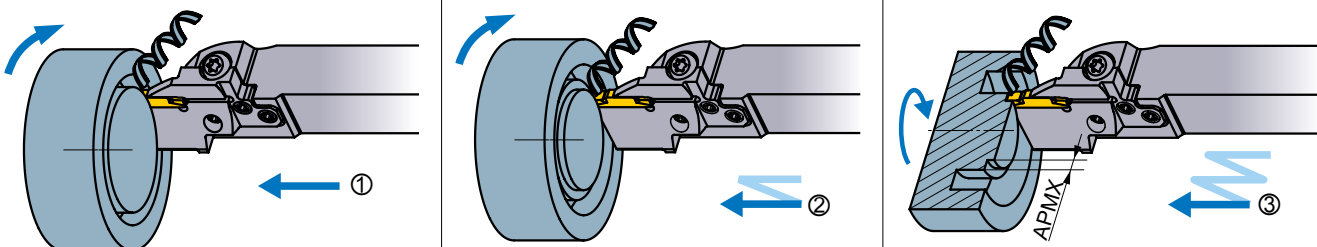

- Beim Schruppen-Mehrfach-Axialeinstechen bearbeiten Sie das Werkstück von aussen nach innen, um eine gute Spanabfuhr zu gewährleisten und die Schneidplatte vor Bruch durch Spänenstau zu schützen.
- Setzen Sie die Einstichbreite auf 60 - 80% der Schneidplattenbreite. Dies verbessert den Spanbruch speziell bei den folgenden Einstichen. Beim ersten Einstich erfolgt eine Spankontrolle, jedoch kein Spanbruch.

#### Hinweise für das Kombinieren von Axialeinstechen mit Stechdrehen (1)

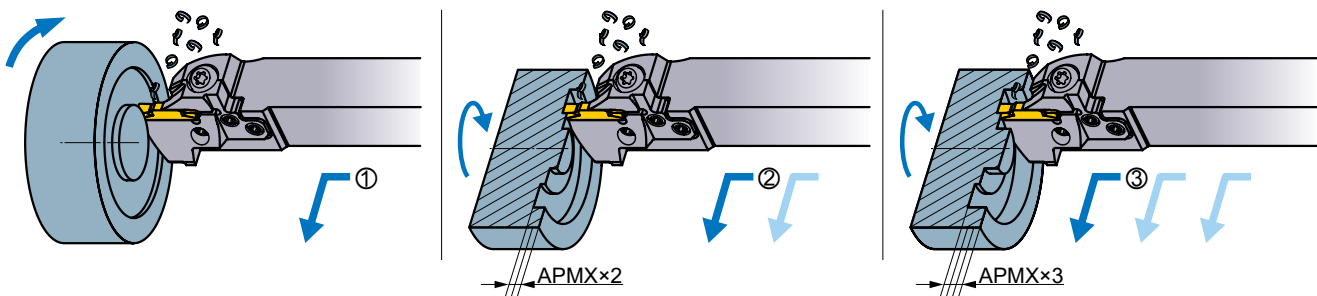

- Beim Axial-Stechdrehen bearbeiten Sie das Werkstück von außen nach innen, um eine gute Spanabfuhr zu gewährleisten.
- Stellen sie die axiale Schnitttiefe innerhalb 40% der Schneidplattenbreite ein.

## Hinweise für das Kombinieren von Axialeinstechen mit Stechdrehen (2)

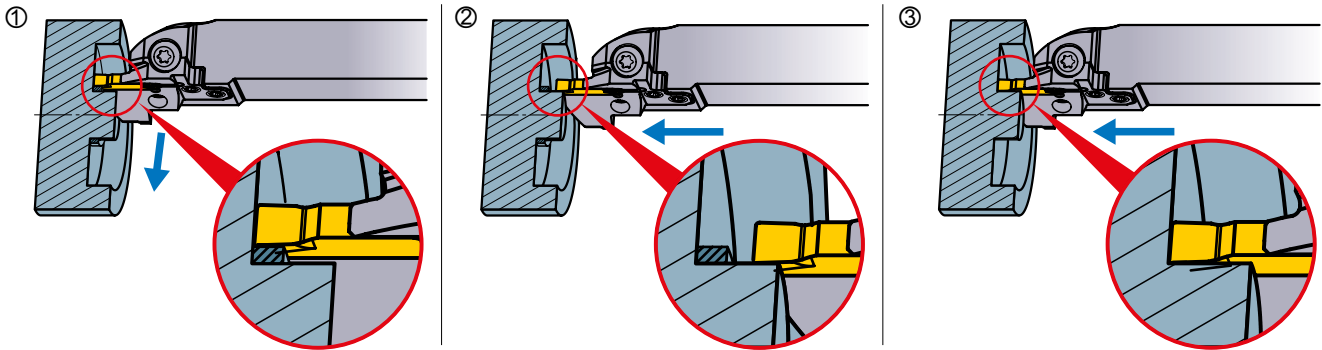

- Beim axialen Kopieren kann es bei Wandungen zu Spänestau kommen. In diesem Fall stoppen Sie kurz vor der Wandung die Bearbeitung und entfernen Sie das Restmaterial durch axiales Einstechen. (Die Schnittbreite sollte kleiner sein als die Schneidplattenbreite)

## Hinweise für das axiale Kopieren (BM-Spanbrecher)

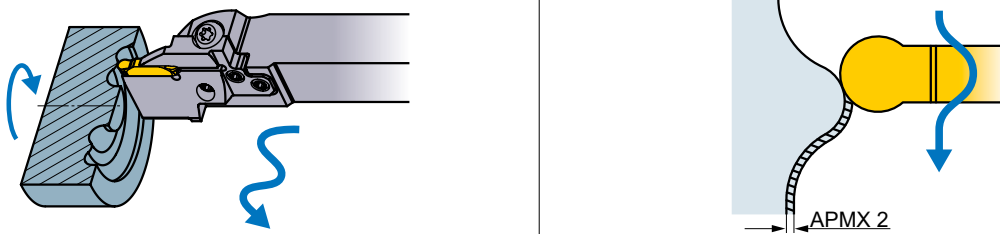

- Mit der Schneidplatte des BM-Spanbrechers ist 3D-Kopieren möglich. Die Schnitttiefe (APMX 2) auf 30% der WSP-Breite einstellen.

## Schlichten (1)

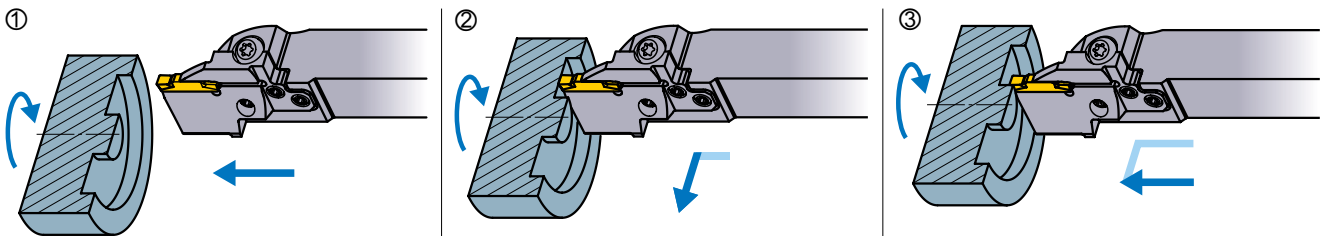

- Beim Schlichten bearbeiten Sie bitte das Werkstück von außen nach innen, abschließend schlichten Sie den inneren Durchmesser auf die richtige Nutabmessung durch axiales Einstechen.

## Schlichten (2) (BM-Spanbrecher)

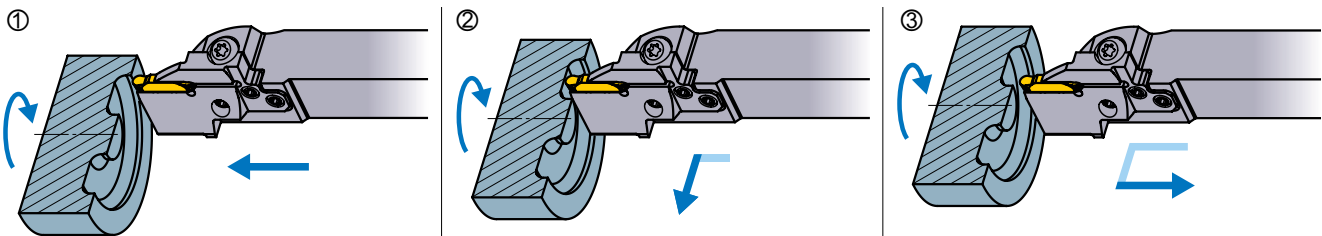

- Die Feinbearbeitung in einem Vorgang ausführen. Die Schnitttiefe (APMX 2) beim Ausstechen entnehmen Sie bitte der Tabelle.

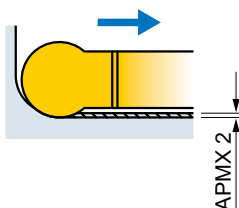

WSP	APMX 2 (mm)
GY2M0200D100N-BM	0.10
GY2M0250E125N-BM	
GY2M0300F150N-BM	
GY2M0318F159N-BM	0.15
GY2M0400G200N-BM	
GY2M0475H238N-BM	0.20
GY2M0500H250N-BM	
GY2M0600J300N-BM	0.25
GY2M0635J318N-BM	

# EINSTECHEN / ABSTECHEN

## EMPFOHLENE SCHNITTGESCHWINDIGKEIT [Innenbearbeitung]

Werkstoff	Härte	Sorte	Schnittgeschwindigkeit (m/min)						
			50	100	150	200	250	300	400
P Baustahl	≤160HB	VP20RT		80		180			
		VP10RT		90		190			
		NX2525		70		170			
	C-Stahl Legierter Stahl	160–280HB	VP20RT	60		140			
			VP10RT	70		150			
			MY5015		90		210		
		NX2525	55		135				
		280HB≤	VP20RT	50		110			
VP10RT	60			120					
M Rostfreier Stahl	≤270HB	VP20RT	50		110				
		VP10RT	60		120				
K Grauguss	Zugfestigkeit ≤300MPa	VP20RT	60		140				
		VP10RT	70		150				
		MY5015		90		210			
	Duktiles Gusseisen	Zugfestigkeit ≤800MPa	VP20RT	50		110			
			VP10RT	60		120			
			MY5015		80		160		
S Hitzebeständige Legierung Titanlegierung	–	MP9015	40		100				
		MP9025	30		90				
		VP20RT	30		60				
		VP10RT/RT9010	40		70				
H Gehärteter Stahl	50HRC≤	BC8110	60		100				
N Aluminiumleg.	Inhalt Si<5%	RT9010				150		400	
						150		400	
	Inhalt 5%≤Si≤10%	RT9010				150		400	
Aluminiumleg.	Inhalt Si>10%	RT9010		80		160			

Hinweis 1) VP20RT ist die erste Empfehlung für alle Werkstoffe außer gehärtete Stähle.  
Hinweis 2) Für RT9010, VP10RT, VP20RT und MY5015 wird der Einsatz von Kühlschmierstoff empfohlen.

## EMPFOHLENE SCHNITTDATEN [Innenbearbeitung]

### INNENEINSTECHEN

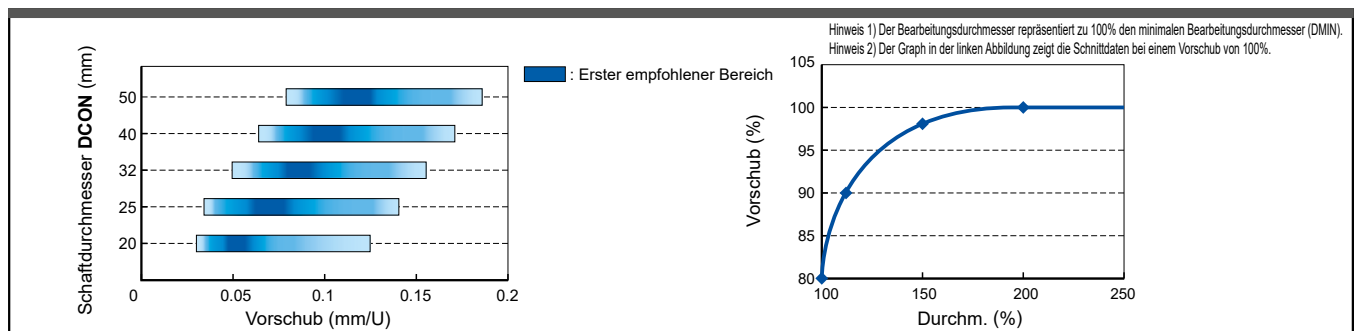

### INNENEINSTECHEN (GL-SPANBRECHER)

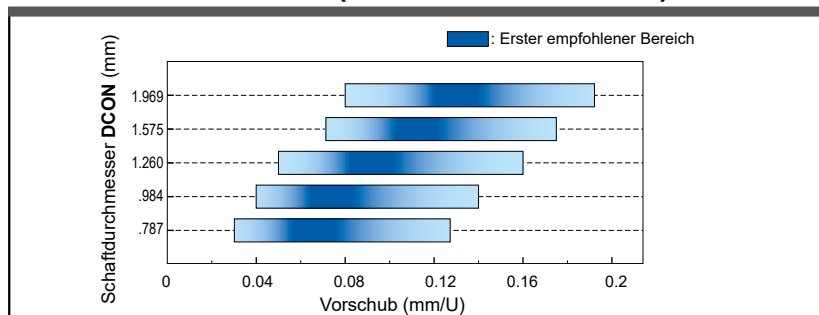

## INNEN PLANDREHEN (MF-SPANBRECHER)

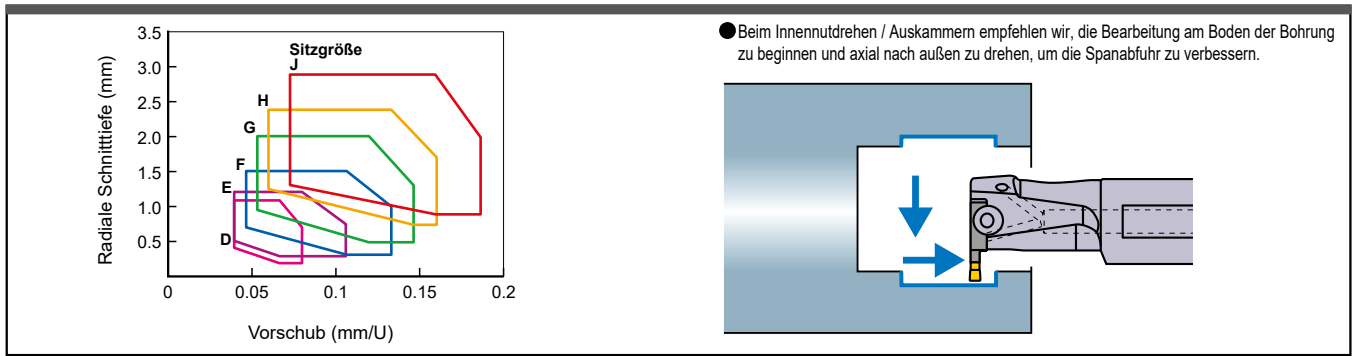

## INNEN PLANDREHEN (MM-/MS-SPANBRECHER)

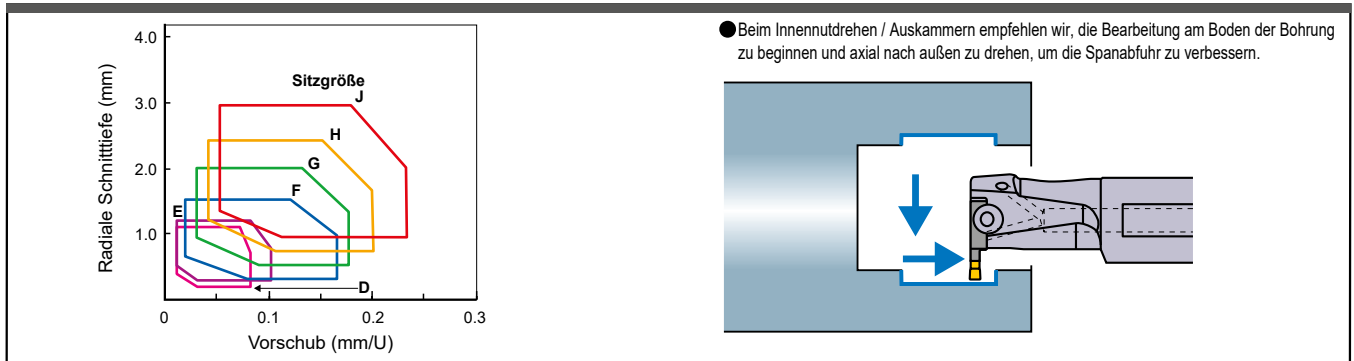

Hinweis 1) Die oben angegebenen Schnittdaten gelten für die Verwendung einer Auskrägung (LU) mit 1.6- bis 2.0-facher Größe des Schaftdurchmessers (DCON). (L/D=1.6-2.0) Ist die Auskrägung L/D größer als 2, müssen Sie die Schnittdaten reduzieren.

Sitzgröße			
	WSP-Stechbreite (mm)		
D	2.00	G	4.00
	2.24	H	4.24
E	2.39	H	4.75
	2.50	H	5.00
F	2.74	H	5.24
	3.00	J	6.00
F	3.18	J	6.31
	3.24	J	6.35

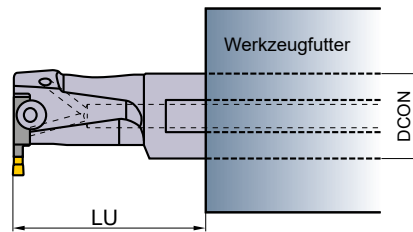

## BEGRENZUNG DER MAXIMALEN SCHNITTtiefe [Innenbearbeitung]

- **Bei Verwendung eines Monoblocks**  
Die maximale Schnitttiefe wird nicht durch den Bearbeitungsdurchmesser begrenzt.
- **Bei Verwendung eines modularen Schwertes**  
Die maximale Schnitttiefe wird durch den Bearbeitungsdurchmesser begrenzt.

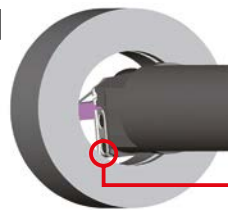

Um eine Kollision zu vermeiden, wird die Einstechtiefe durch den Bearbeitungsdurchmesser begrenzt.

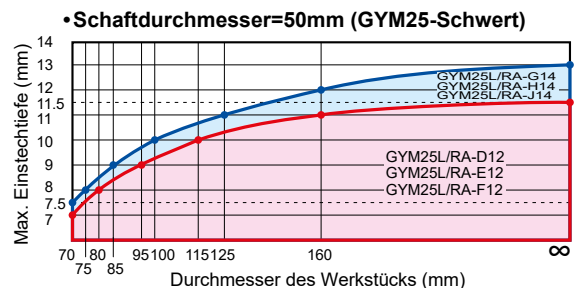
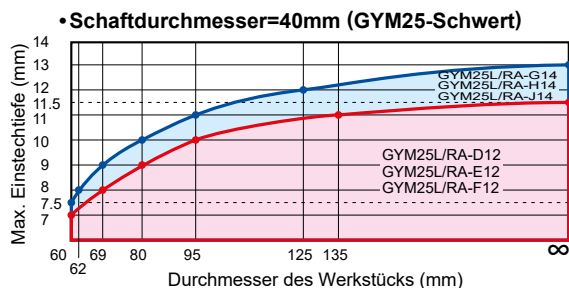
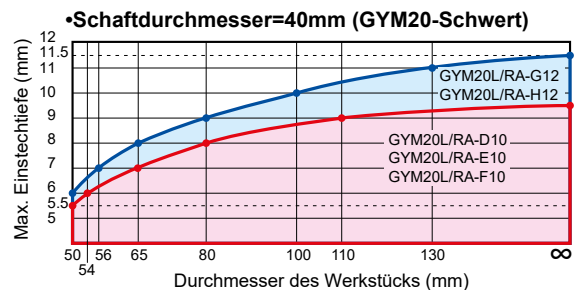
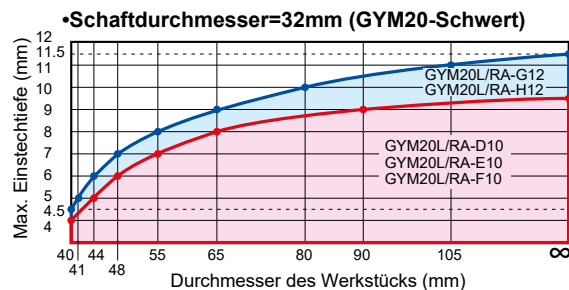

## WERKZEUGAUSWAHL

### Hinweise zur Auswahl der Werkzeughalter

**Halter**

Wählen Sie bei gleicher Auskrägung einen Halter mit größtmöglicher Schaftgröße, um eine ausreichende Werkstückspannung sicherzustellen.

**Modulares Schwert (1)**

GYM20R/LA-0000

GYM20R/LA-D10  
GYM20R/LA-E10  
GYM20R/LA-F10  
GYM20R/LA-G12  
GYM20R/LA-H12

GYM25R/LA-0000

GYM25R/LA-D12  
GYM25R/LA-E12  
GYM25R/LA-F12  
GYM25R/LA-G14  
GYM25R/LA-H14  
GYM25R/LA-J14

Für einen Innenhalter wählen Sie eines der oben aufgelisteten modularen Schwerter.

**Modulares Schwert (2)**

Sofern keine Einschränkung besteht, wählen Sie für einen Halter mit einem  $\varnothing 40$ -Schaft einen Halter, der für GYM25-Schwerter geeignet ist.

### Hinweise zum Einsetzen des Werkzeuges

**Auskrägung**

Die maximale Einstechtiefe wird durch die Abmessung LDRED begrenzt. Bei der Bearbeitung mit längeren Auskrägungen sollten Sie sich an Abmessung WF2 des verwendeten Werkzeuges orientieren.



## BEARBEITUNGSEMPFEHLUNGEN

### Hinweise für multifunktionale Bearbeitung (MF, MS- und MM- Spanbrecher)

Beim Inneneinsteichen können die Bearbeitungsmethoden für das Außeneinsteichen verwendet werden. Bei Folgendem ist jedoch Vorsicht geboten.

#### Kühlmittel

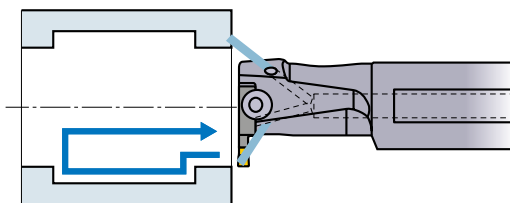

- Verwenden Sie zur effektiven Spanabfuhr viel Kühlmittel für die Schneidkante. Außerdem sollten Sie zur besseren Spanabfuhr solange Kühlmittel zuführen, bis sich das Werkzeug vollständig vom Werkstück entfernt hat.

#### Innennutdrehen

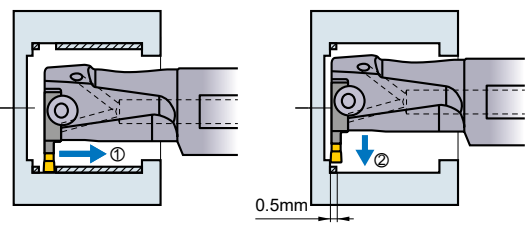

- Da zusammenhängende Späne häufig am Bohrungsende länger werden, sind die oben dargestellten Schritte zu empfehlen. Die empfohlene Zustellung für ② ist 0.5mm.

### Bearbeitung breiter Nuten

#### Stechwerkzeuge

- Wenn die Breite der Schneidkante  $\times 2 \geq$  Einstechbreite ist

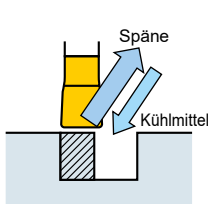

- Wenn die Schnitttiefe niedriger ist als die Breite der Schneidkante, kommt es normalerweise zur Bildung von Fließspänen. Beim Nutdrehen wird empfohlen, die Bearbeitung in den oben dargestellten Schritten durchzuführen. Dadurch wird sichergestellt, dass das Kühlmittel die Schneidkante erreicht und Späne leicht entsorgt werden.

- Wenn die Breite der Schneidkante  $\times 2 <$  Einstechbreite ist

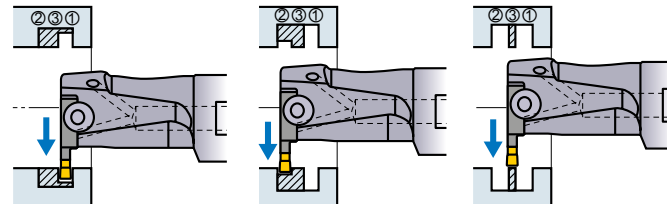

- Wenn die Einstechtiefe größer ist als die Breite der Schneidkante, führen Sie das Einstechen in den oben dargestellten Schritten durch, um effiziente Spanbrechung zu erzielen.

#### Drehen

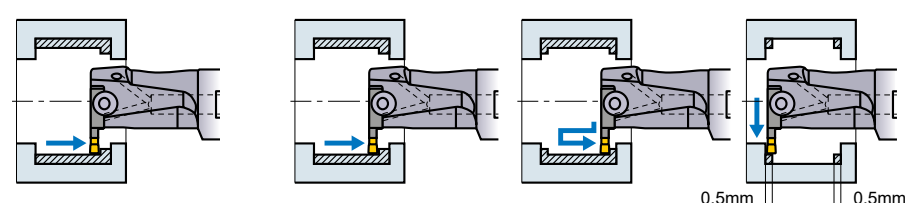

- Wenn die Spanbrechung und Abfuhr wichtig ist, empfehlen wir Innenlängsdrehen.
- Für die Innenbearbeitung breiter, flacher Nuten ist das Stechdrehen wie oben angegeben einzusetzen. (Wenn der Radius des Werkstückes größer ist als der Radius des Werkzeuges, empfehlen wir die Bearbeitungsempfehlung für das Außeneinsteichen.)
- Wenn der Einstich eine bestimmte Tiefe überschreitet, können Späne an der Wandung länger werden. In einem solchen Fall müssen Sie den Vorschub erhöhen und die Bearbeitung wie oben erläutert durchführen.

#### Empfehlung zur Bearbeitung

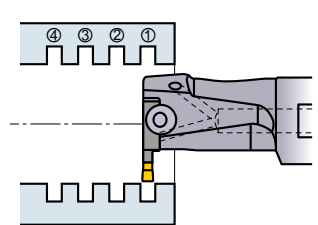

- Es wird empfohlen, das Einstechen vom vorderen Boden des Werkstücks aus durchzuführen. Dies reduziert die Werkstückablenkung.

# GW SERIE

## Benutzerfreundliche Montage für eine verbesserte Handhabung des Werkzeugs

### Klemmverfahren

#### Einfache Stechplattenklemmmethode mit hoher Steifigkeit

Das Lösen der Schneidplatte aus dem Plattensitz wird durch einen Konuswinkel verhindert. Zusätzlich bietet diese Bauweise drei große Anlageflächen am Stechschwert für höchste Zuverlässigkeit der Schneidkante. Das Stechschwert selber besteht aus einer dafür geeigneten speziellen Stahllegierung. Zum Wechseln der WSP wird ein spezieller Schlüssel mitgeliefert, der die Benutzung vereinfacht.



Konuswinkel

### Entwicklerkommentar

#### Einfache Stechplatten-Montage

Durch einen Spezielschlüssel lässt sich die Stechplatte in einem einfachen Arbeitsgang herausnehmen. Dies vereinfacht den täglichen Umgang in der Anwendung.

7

EINSTECHEN / ABSTECHEN



## Stechschwert mit Kühlmittelzufuhr

### Hoher Verschleißwiderstand durch zwei interne Kühlmittelbohrungen

Zwei interne Kühlmittelbohrungen führen das Kühlmittel an die Span- und Freifläche.

Dadurch wird die Schneidkante deutlich gekühlt und der Verschleißwiderstand steigt.

Darüber hinaus kann das Blatt wahlweise mit Hoch- oder Niederdruckkühlmittel (7 mpa) eingesetzt werden.

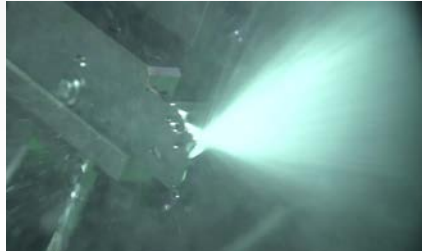

#### Entwicklerkommentar

##### Reduzierte Wärmeentwicklung

Die beiden Kühlmittelbohrungen im Stechschwert halten einem Druck von bis zu 70 bar stand.

Dies wird durch die Verwendung des größtmöglichen Bohrungsdurchmessers möglich. Die Kühlmittelbohrungen befinden sich zur besseren Kühlung und Erhöhung des Verschleißwiderstands nahe bei der Schneidkante.

## Kühlmittelanschlüsse

### Flexibilität durch Verwendung von sechs Kühlmittelanschlüssen

Am Werkzeugblock befinden sich sechs Kühlmittelanschlüsse zur mühelosen Einrichtung des Blocks und des Stechschwerts in einer geeigneten Konfiguration. Die internen Kühlmittelbohrungen verbessern die Kühlung der Schneidkante und die Spanabfuhr. Die Verwendung externer Kühlmittelschläuche ist ebenfalls möglich.

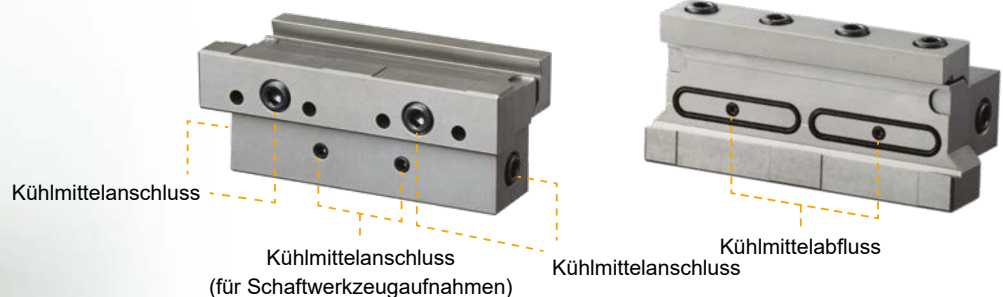

#### Entwicklerkommentar

##### Kann auf die Anforderungen der Werkstatsumgebung abgestimmt werden.

Mit diesem Produkt soll unter anderem den Hinweisen von Kunden, dass das Produkt „nicht passte und nicht verwendet werden konnte“, entgegengewirkt werden. Angefangen bei dem Kühlmittelabfluss, der selbst bei Änderungen der Ölmengen oder Auskragungen keine Leckagen verursacht, wurden vom Werkstoff und der Form des O-Rings bis hin zur Länge des Schlauchs alle Komponenten für den effizienten Einsatz in der Fertigung konzipiert.

## Spanbrechersystem mit ausgezeichneten Spanabfuhereigenschaften

### Geringer Vorschub



### Mittlerer Vorschub



## HARTMETALLSORTEN

Werkstoff	<b>P</b> Stahl	<b>M</b> Rostfreier Stahl	<b>K</b> Gusseisen	<b>S</b> Warmfeste Leg. / Titanleg.
Schnittdaten	<b>MY5015</b>		<b>MY5015</b>	
Stabile ↑	<b>VP10RT</b>	<b>VP10RT</b>	<b>VP10RT</b>	<b>VP10RT</b>
Schnittdaten ↓	<b>VP20RT</b>	<b>VP20RT</b>	<b>VP20RT</b>	<b>VP20RT</b>
Instabil ↓	<b>VP30RT</b>	<b>VP30RT</b>		

EINSTECHEN / ABSTECHEN

### VP20RT (1. Empfehlung)

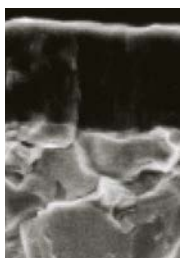

- PVD-beschichtete Sorte für einen breiten Anwendungsbereich. Die Kombination aus einem speziellen Hartmetallsustrat und der MIRACLE-Beschichtung bewirkt ein ausgezeichnetes Verhältnis zwischen Verschleiß- und Bruchfestigkeit.

MIRACLE-Beschichtung  
 Hartmetallsustrat (90.5HRA)

### MY5015

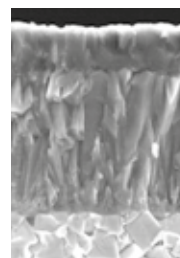

- CVD-beschichtete Sorte mit ausgezeichnetem Verschleißwiderstand auch bei hohen Temperaturen. Längere Werkzeugstandzeit bei der Bearbeitung von Gusseisen und duktilem Gusseisen. Auch für die Hochgeschwindigkeitsbearbeitung im Stahlbereich geeignet.

CVD-Beschichtung  
 Hartmetallsustrat

### VP10RT

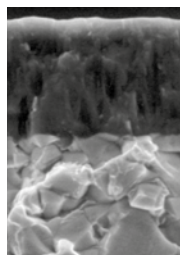

- PVD-beschichtete Sorte mit einem Hartmetallsustrat, das härter ist als VP20RT. Einsetzbar bei schwer zu bearbeitenden Werkstoffen und Erreichung einer längeren Werkzeugstandzeit.

MIRACLE-Beschichtung  
 Hartmetallsustrat (92.0HRA)

### VP30RT

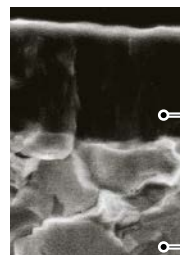

- Eine Kombination aus einem speziellen, zähen Hartmetallsustrat und der MIRACLE-Beschichtung. Ideal für den Einsatz im unterbrochenen Schnitt von rostfreiem und allgemeinem Stahl.

MIRACLE-Beschichtung (Al,Ti)N  
 Hartmetallsustrat (88.8HRA)

# BESTELLBEZEICHNUNG SERIE GY

## WSP / Stechschwert / Werkzeugblock

### WSP

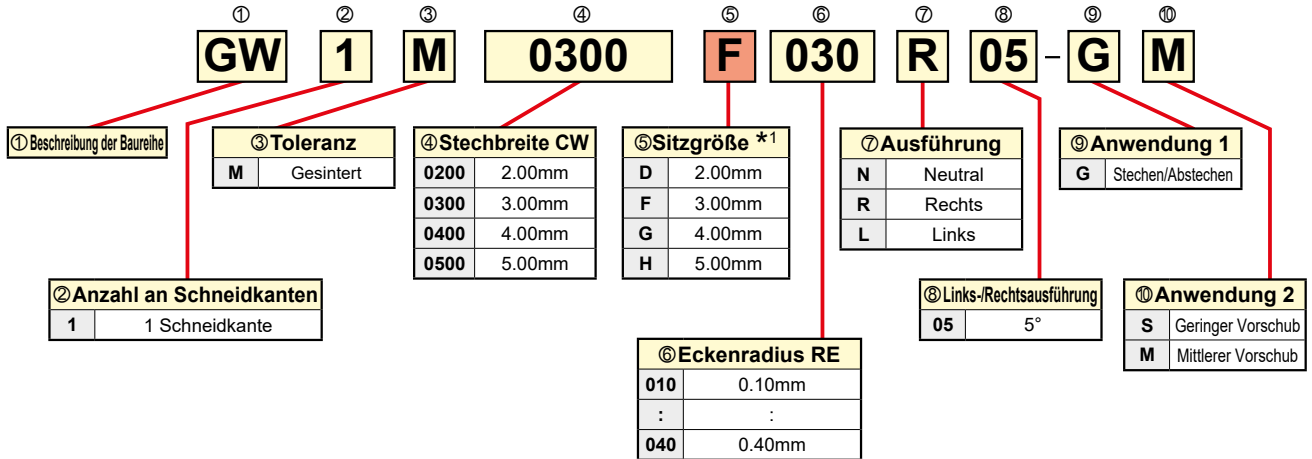

### Stechschwert

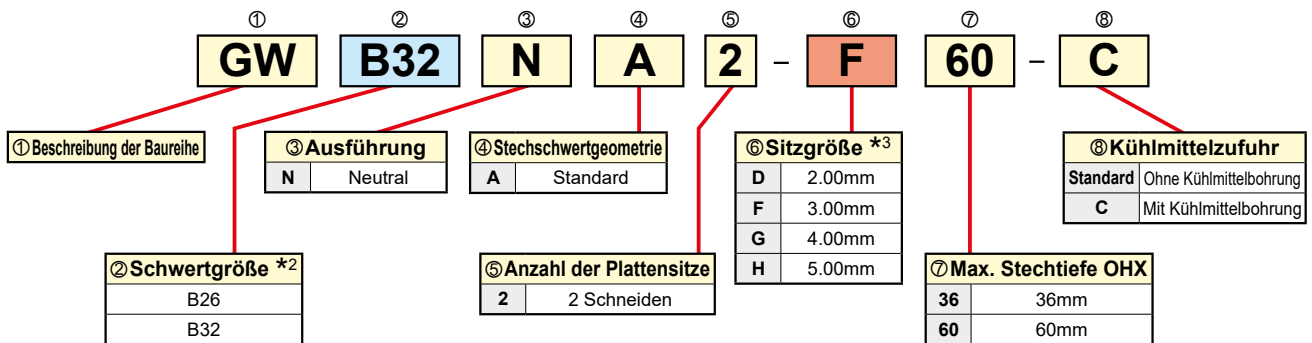

### Werkzeugblock

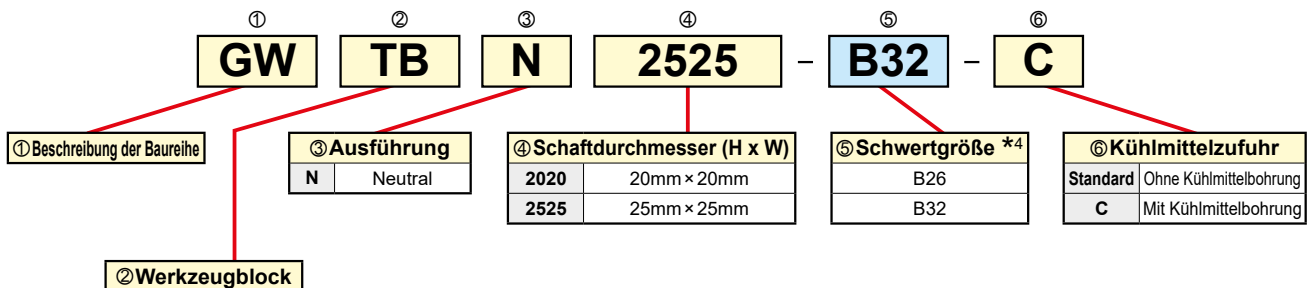

- \*1 Sitzgröße, mit demselben Symbol das Stechschwert auswählen.
- \*2 Stechschwert, mit demselben Symbol den Werkzeugblock auswählen.
- \*3 Sitzgröße, mit demselben Symbol die Stechplatte auswählen.
- \*4 Stechschwertgröße, mit demselben Symbol das Stechschwert auswählen.

# EINSTECHEN / ABSTECHEN

## GW Stechschwert

- Einfaches Klemmen der Schneidplatte und hohe Steifigkeit.
- Kann sowohl mit externer als auch interner Kühlmittelzufuhr verwendet werden.
- Einstechtiefe CW 2.0—5.0mm

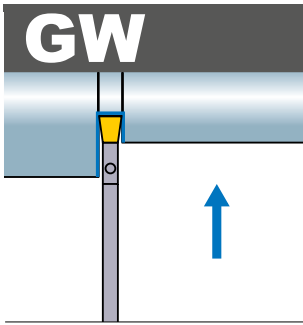

Für externes Abstechen / Einstechen

Abb.1



Abb.2



Ohne Kühlmittelbohrung

(mm)

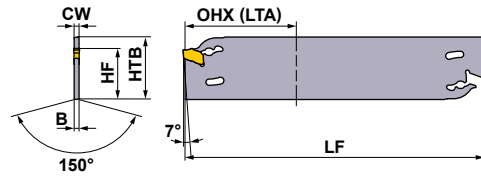
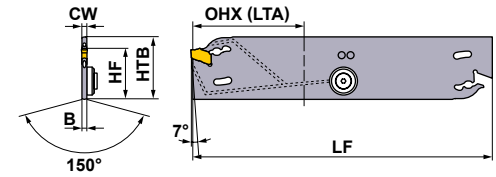
Sitzgröße	CW	*1 CUTDIA	Bestellbezeichnung	Lager	*2 OHN	*3 OHX (LTA)	B	LF	HTB	HF	Bild	Werkzeugblock-Typ		
												Typ	Schlüssel	
D	2.00	72	<b>GWB26NA2-D36</b>	●	16	36	1.55	110	26	21.4	1	GW1M0200D	GWY39L	GW TBN-B26
		120	<b>GWB32NA2-D60</b>	●	16	60	1.55	150	32	25	1	GW1M0200D	GWY39L	GW TBN-B32
F	3.00	72	<b>GWB26NA2-F36</b>	●	16	36	2.45	110	26	21.4	1	GW1M0300F	GWY39L	GW TBN-B26
		120	<b>GWB32NA2-F60</b>	●	16	60	2.45	150	32	25	1	GW1M0300F	GWY39L	GW TBN-B32
G	4.00	72	<b>GWB26NA2-G36</b>	●	19	36	3.35	110	26	21.4	1	GW1M0400G	GWY39L	GW TBN-B26
		120	<b>GWB32NA2-G60</b>	●	19	60	3.35	150	32	25	1	GW1M0400G	GWY39L	GW TBN-B32
H	5.00	72	<b>GWB26NA2-H36</b>	●	19	36	4.25	110	26	21.4	1	GW1M0500H	GWY39L	GW TBN-B26
		120	<b>GWB32NA2-H60</b>	●	19	60	4.25	150	32	25	1	GW1M0500H	GWY39L	GW TBN-B32

Mit Kühlmittelbohrung

(mm)

Sitzgröße	CW	*1 CUTDIA	Bestellbezeichnung	Lager	*2 OHN	*3 OHX (LTA)	B	LF	HTB	HF	Bild	Werkzeugblock-Typ		
												Typ	Schlüssel	
D	2.00	72	<b>GWB26NA2-D36-C</b>	●	16	36	1.55	110	26	21.4	2	GW1M0200D	GWY39L	GW TBN-B26-C
		120	<b>GWB32NA2-D60-C</b>	●	26	60	1.55	150	32	25	2	GW1M0200D	GWY39L	GW TBN-B32-C
F	3.00	72	<b>GWB26NA2-F36-C</b>	●	16	36	2.45	110	26	21.4	2	GW1M0300F	GWY39L	GW TBN-B26-C
		120	<b>GWB32NA2-F60-C</b>	●	26	60	2.45	150	32	25	2	GW1M0300F	GWY39L	GW TBN-B32-C
G	4.00	72	<b>GWB26NA2-G36-C</b>	●	19	36	3.35	110	26	21.4	2	GW1M0400G	GWY39L	GW TBN-B26-C
		120	<b>GWB32NA2-G60-C</b>	●	26	60	3.35	150	32	25	2	GW1M0400G	GWY39L	GW TBN-B32-C
H	5.00	72	<b>GWB26NA2-H36-C</b>	●	19	36	4.25	110	26	21.4	2	GW1M0500H	GWY39L	GW TBN-B26-C
		120	<b>GWB32NA2-H60-C</b>	●	26	60	4.25	150	32	25	2	GW1M0500H	GWY39L	GW TBN-B32-C

\*1 CUTDIA : maximaler Abstechdurchmesser \*2 OHN : Mindestauskragslänge \*3 OHX(LTA) : Höchste Auskragslänge  
Hinweis 1) Empfohlener Kühlmittelhöchstdruck : 70 Bar

### Ersatzteile für Stechschwerter mit Kühlmittelbohrung (mm)

Bestellbezeichnung	CW	①		②	③
		Unterlegscheibe	Spannschraube		
<b>GWB26NA2-D36-C</b>	2.0	①GWW04038	GW04005F	HKY20R	
<b>GWB32NA2-D60-C</b>	2.0	①GWW04038	GW04005F	HKY20R	
<b>GWB26NA2-F36-C</b>	3.0	①GWW04038	GW04005F	HKY20R	
<b>GWB32NA2-F60-C</b>	3.0	①GWW04038	GW04005F	HKY20R	
<b>GWB26NA2-G36-C</b>	4.0	②GWW04026	GW04005F	HKY20R	
<b>GWB32NA2-G60-C</b>	4.0	②GWW04026	GW04005F	HKY20R	
<b>GWB26NA2-H36-C</b>	5.0	②GWW04026	GW04005F	HKY20R	
<b>GWB32NA2-H60-C</b>	5.0	②GWW04026	GW04005F	HKY20R	

● : Lagerstandard. ★ : Lagerstandard in Japan.



## Werkzeugblock

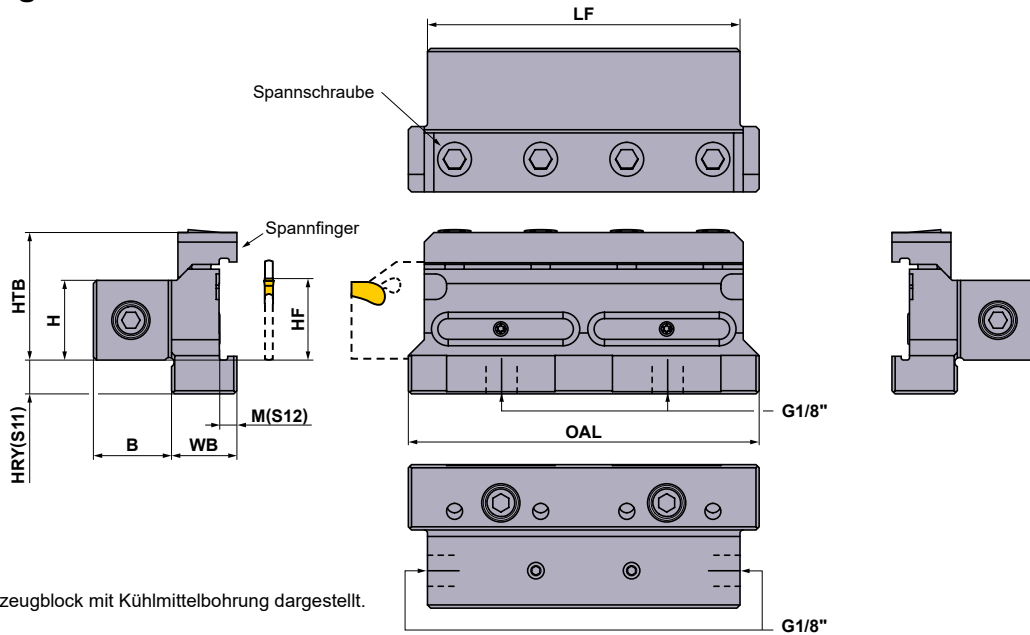

Werkzeugblock mit Kühlmittelbohrung dargestellt.

Ohne Kühlmittelbohrung

Bestellbezeichnung	Lager	H	HF	HTB	HRY (S11)	B	WB	M (S12)	LF	OAL	(mm)		
											Spannfinger	Spannschraube	Schlüssel
<b>GWTCN2020-B26</b>	★	20	20	33.5	11	19.5	20.0	5.0	75	85	① GWCW1	HSC06020	HKY50R
<b>GWTCN2020-B32</b>	★	20	20	35.0	15.6	19.5	20.5	5.5	100	110	② GWCW2	HSC06020	HKY50R
<b>GWTCN2525-B26</b>	★	25	25	38.5	6	24.5	20.0	5.0	75	85	① GWCW1	HSC06020	HKY50R
<b>GWTCN2525-B32</b>	★	25	25	40.0	10.6	24.5	20.5	5.5	100	110	② GWCW2	HSC06020	HKY50R

Mit Kühlmittelbohrung

Bestellbezeichnung	Lager	H	HF	HTB	HRY (S11)	B	WB	M (S12)	LF	OAL	(mm)		
											Spannfinger	Spannschraube	Schlüssel
<b>GWTCN2020-B26-C</b>	●	20	20	33.5	11	19.5	20.0	5.0	75	85	① GWCW1	HSC06020	HKY50R
<b>GWTCN2020-B32-C</b>	●	20	20	35.0	15.6	19.5	20.5	5.5	100	110	② GWCW2	HSC06020	HKY50R
<b>GWTCN2525-B26-C</b>	●	25	25	38.5	6	24.5	20.0	5.0	75	85	① GWCW1	HSC06020	HKY50R
<b>GWTCN2525-B32-C</b>	●	25	25	40.0	10.6	24.5	20.5	5.5	100	110	② GWCW2	HSC06020	HKY50R

\* Spannmoment (N • m) : HSC06020=7.0

Hinweis 1) Empfohlener Kühlmittelhöchstdruck : 70 Bar

## Ersatzteile für Werkzeugblock mit Kühlmittelbohrung

Bestellbezeichnung	O-Ring	Stopfen	Stopfen	Schlüssel	Stopfen	Schlüssel
<b>GWTCN2020-B26-C</b>	ORGW332N9	HGJ-PT1/8	HSD05004S	HKY25R	CS300590T	TKY08R
<b>GWTCN2020-B32-C</b>	ORGW457N9	HGJ-PT1/8	HSD05004S	HKY25R	CS300590T	TKY08R
<b>GWTCN2525-B26-C</b>	ORGW332N9	HGJ-PT1/8	HSD05004S	HKY25R	CS300590T	TKY08R
<b>GWTCN2525-B32-C</b>	ORGW457N9	HGJ-PT1/8	HSD05004S	HKY25R	CS300590T	TKY08R



# EINSTECHEN / ABSTECHEN

## WSP

(mm)

Anwendung	Bestellbezeichnung	Lager					CW		REL	RER	PSIRR PSIRL	Geometrie
		Beschichtung			Hartmetall		Stechbreite	Toleranz				
		MY5015	VP10RT	VP20RT	VP30RT	RT9010						
Einstechen, Abstechen	<b>GW1M0200D020N-GS</b>	●	●	●			2.00	±0.03	0.2	0.2	—	
Einstechen, Abstechen	<b>GW1M0300F020N-GS</b>	●	●	●			3.00	±0.03	0.2	0.2	—	
Einstechen, Abstechen	<b>GW1M0400G020N-GS</b>	●	●	●			4.00	±0.04	0.2	0.2	—	
Einstechen, Abstechen	<b>GW1M0500H030N-GS</b>	●	●	●			5.00	±0.04	0.3	0.3	—	
Einstechen, Abstechen	<b>GW1M0200D020N-GM</b>	●	●	●			2.00	±0.03	0.2	0.2	—	
Einstechen, Abstechen	<b>GW1M0300F030N-GM</b>	●	●	●			3.00	±0.03	0.3	0.3	—	
Einstechen, Abstechen	<b>GW1M0400G030N-GM</b>	●	●	●			4.00	±0.04	0.3	0.3	—	
Einstechen, Abstechen	<b>GW1M0500H040N-GM</b>	●	●	●			5.00	±0.04	0.4	0.4	—	
Abstechen, niedriger Vorschub	<b>NEW GW1M0200D020R05-GS</b>	★	★	★			2.00	±0.03	0.2	0.2	5	
Abstechen, niedriger Vorschub	<b>NEW GW1M0300F020R05-GS</b>	★	★	★			3.00	±0.03	0.2	0.2	5	
Abstechen mit niedrigem Vorschub, 8° Steigungswinkel	<b>NEW GW1M0200D003R08-GS</b>	★	★	★			2.00	±0.03	0.03	0.03	8	
Abstechen mit niedrigem Vorschub, 8° Steigungswinkel	<b>NEW GW1M0300F003R08-GS</b>	★	★	★			3.00	±0.03	0.03	0.03	8	
Abstechen	<b>GW1M0200D020R05-GM</b>	●	●	●			2.00	±0.03	0.2	0.2	5	
Abstechen	<b>GW1M0200D020L05-GM</b>	●	●	●			2.00	±0.03	0.2	0.2	5	
Abstechen	<b>GW1M0300F030R05-GM</b>	●	●	●			3.00	±0.03	0.3	0.3	5	
Abstechen	<b>GW1M0300F030L05-GM</b>	●	●	●			3.00	±0.03	0.3	0.3	5	
Abstechen	<b>GW1M0400G030R05-GM</b>	●	●	●			4.00	±0.04	0.3	0.3	5	
Abstechen	<b>GW1M0400G030L05-GM</b>	●	●	●			4.00	±0.04	0.3	0.3	5	
Abstechen	<b>GW1M0500H040R05-GM</b>	●	●	●			5.00	±0.04	0.4	0.4	5	
Abstechen	<b>GW1M0500H040L05-GM</b>	●	●	●			5.00	±0.04	0.4	0.4	5	
											Abbildung zeigt rechte WSP.	
Glatt	<b>NEW GW1B0320D020N</b>				★	★	3.24	±0.10	0.2	0.2	—	
Glatt	<b>NEW GW1B0440F020N</b>				★	★	4.44	±0.10	0.2	0.2	—	
Glatt	<b>NEW GW1B0540G020N</b>				★	★	5.44	±0.10	0.2	0.2	—	
Glatt	<b>NEW GW1B0640H020N</b>				★	★	6.44	±0.10	0.2	0.2	—	

Hinweis 1) WSP-Rohlinge müssen bedarfsgerecht selbst geschliffen werden.

## Richtige Verwendung von GW-Stechplatten in Rechtsausführung

### 1. Empfehlung

Verbesserte Bruchfestigkeit

Verminderung von Grat und Butzen im Zentrum

**GM-Spanbrecher**

PSIRR=5°  
RE=0.20

Verringerung des Schnittdrucks

**GS-Spanbrecher**

PSIRR=5°  
RE=0.20

Verbesserte Bruchfestigkeit

**GS-Spanbrecher**



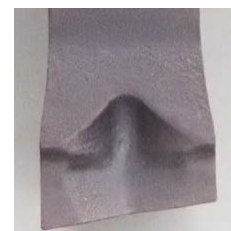

PSIRR=8°  
RE=0.03



● : Lagerstandard. ★ : Lagerstandard in Japan.  
(10 WSP je VPE)

## Kühlmittelschlauch-Kit

(mm)

Anschlusstyp	Bestellbezeichnung	Lager	Schlauchlänge	Kit-Detailangaben								
												
				Code-Nr.	Code-Nr.	Stk.	Code-Nr.	Stk.	Code-Nr.	Stk.	Code-Nr.	Stk.
Gerade	<b>CS-1/8-150SS</b>	●	150	HOSE-1/8-150	—	—	—	—	AD-G1/8	2	WA-M10	2
Gerade	<b>CS-1/8-200SS</b>	●	200	HOSE-1/8-200	—	—	—	—	AD-G1/8	2	WA-M10	2
Gerade	<b>CS-1/8-250SS</b>	●	250	HOSE-1/8-250	—	—	—	—	AD-G1/8	2	WA-M10	2
Gerade	<b>CS-1/8-300SS</b>	●	300	HOSE-1/8-300	—	—	—	—	AD-G1/8	2	WA-M10	2
Winkel gerade	<b>CS-1/8-150BS</b>	●	150	HOSE-1/8-150	AD-BM10	1	BB-G1/8	1	AD-G1/8	1	WA-M10	3
Winkel gerade	<b>CS-1/8-200BS</b>	●	200	HOSE-1/8-200	AD-BM10	1	BB-G1/8	1	AD-G1/8	1	WA-M10	3
Winkel gerade	<b>CS-1/8-250BS</b>	●	250	HOSE-1/8-250	AD-BM10	1	BB-G1/8	1	AD-G1/8	1	WA-M10	3
Winkel gerade	<b>CS-1/8-300BS</b>	●	300	HOSE-1/8-300	AD-BM10	1	BB-G1/8	1	AD-G1/8	1	WA-M10	3
Winkel	<b>CS-1/8-150BB</b>	●	150	HOSE-1/8-150	AD-BM10	2	BB-G1/8	2	—	—	WA-M10	4
Winkel	<b>CS-1/8-200BB</b>	●	200	HOSE-1/8-200	AD-BM10	2	BB-G1/8	2	—	—	WA-M10	4
Winkel	<b>CS-1/8-250BB</b>	●	250	HOSE-1/8-250	AD-BM10	2	BB-G1/8	2	—	—	WA-M10	4
Winkel	<b>CS-1/8-300BB</b>	●	300	HOSE-1/8-300	AD-BM10	2	BB-G1/8	2	—	—	WA-M10	4

Größe der Verbindungsschraube = G1/8"

## Montagebeispiel

Winkel gerade Typ

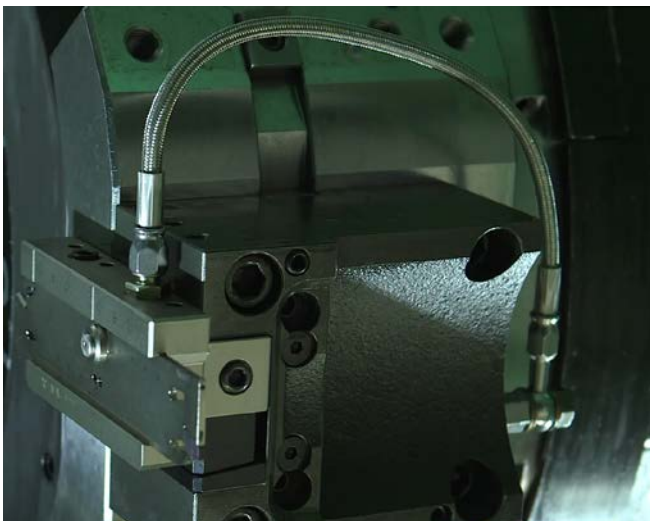

Winkel Typ

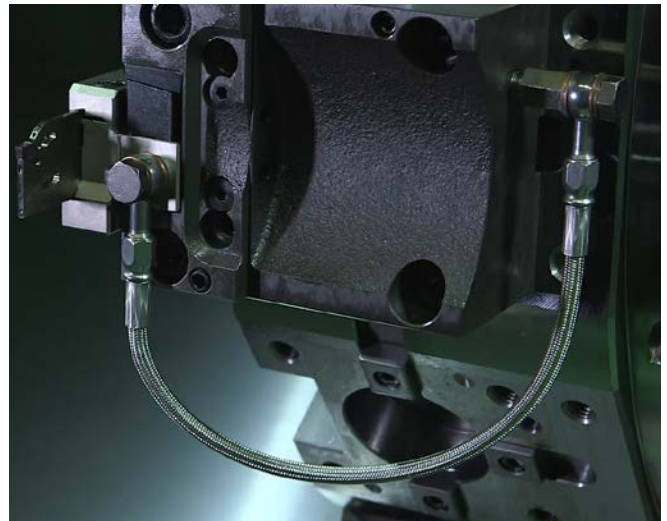

T

EINSTECHEN / ABSTECHEN

## SCHNITTDATENEMPFEHLUNG

### ■ Schnittgeschwindigkeit

Werkstoff	Härte	Sorte	Schnittgeschwindigkeit (m/min)						
			50	100	150	200	250	300	
P Baustahl	≤160HB	VP20RT		100		240			
		VP10RT		110		250			
	C-Stahl Legierter Stahl	160–280HB	VP20RT		80		200		
			VP10RT		90		210		
			VP30RT		60		180		
			MY5015		110		250		
		≥280HB	VP20RT		60		160		
			VP10RT		70		170		
			VP30RT		40		140		
			MY5015		90		210		
M Rostfreier Stahl	≤270HB	VP20RT		60		180			
		VP10RT		70		190			
		VP30RT		40		160			
K Grauguss	Zugfestigkeit ≤300MPa	VP20RT		80		200			
		VP10RT		90		210			
		MY5015				140		300	
	Duktiles Gusseisen	Zugfestigkeit ≤800MPa	VP20RT		60		160		
			VP10RT		70		170		
			MY5015		90		210		
S Hitzebeständige Legierung Titanlegierung	–	VP20RT	30	60					
		VP10RT	40	70					

Hinweis 1) VP20RT ist die erste empfohlene Sorte für allgemeine Werkstoffe.

Hinweis 2) Für VP10RT, VP20RT, VP30RT und MY5015 wird Nassbearbeitung empfohlen.

## ■ Vorschub pro Umdrehung

### GM-Spanbrecher

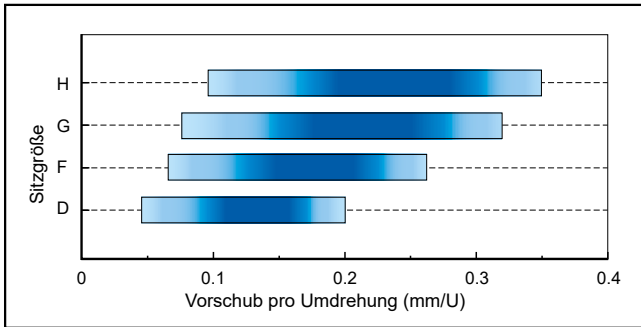

### GS-Spanbrecher

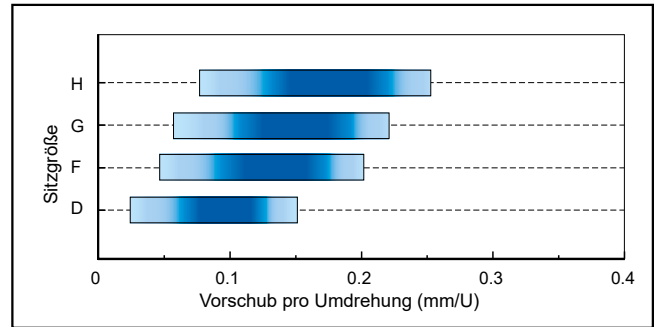

Spanbrecher	Vorschub pro Umdrehung (mm/U)			
	Sitzgröße D	Sitzgröße F	Sitzgröße G	Sitzgröße H
GM-Spanbrecher	0.05–0.20	0.07–0.26	0.08–0.32	0.10–0.35
GS-Spanbrecher	0.03–0.15	0.05–0.20	0.06–0.22	0.08–0.25

## ■ Abstechen, Vorschub je Umdrehung

### R05-GS-Spanbrecher

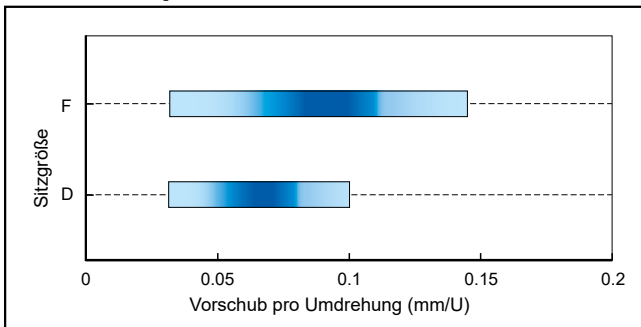

### R08-GS-Spanbrecher

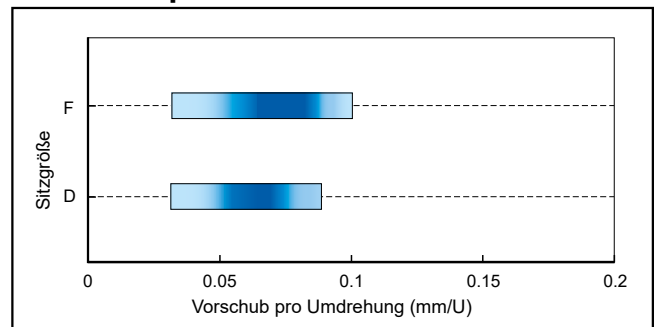

### R/L05-GM-Spanbrecher

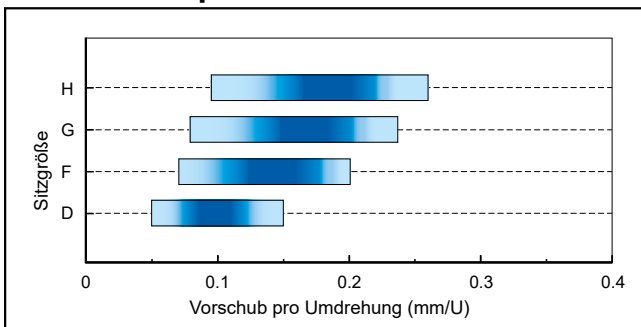

Spanbrecher	PSIPR	Ausführung	Vorschub pro Umdrehung (mm/U)			
			Sitzgröße D	Sitzgröße F	Sitzgröße G	Sitzgröße H
R05-GS	5°	R	0.03–0.10	0.03–0.14	–	–
R08-GS	8°	R	0.03–0.08	0.03–0.14	–	–
R05-GM	5°	R/L	0.05–0.15	0.07–0.20	0.08–0.23	0.10–0.26

# EINSTECHEN / ABSTECHEN

# MGHALTER

- Spannfingerklemmung.
- Positiver Schnitt für beste Schlichtoberfläche.
- Stechbreite CW 1.25–6.0mm.

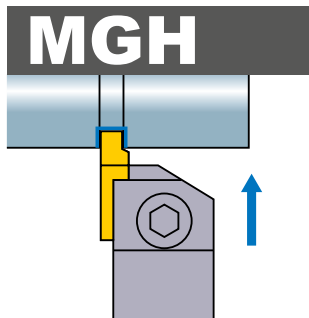

## Aussen Einstechen







Abb. zeigt Rechtsausführung.

Bestellbezeichnung	Lager		WSP Bezeichnung	Abmessungen (mm)						
	R	L		CW	CDX	H	B	LF	HF	WF
MGHR/L2020K3315	●	●	MGTR/L 33125   33400	1.25	1.2	20	20	125	20	20.2
MGHR/L2020K3323	●	●		1.45	1.5					
MGHR/L2525M3315	●	●		1.5 ≤ CW ≤ 2.3	3.0					
MGHR/L2525M3323	●	●		2.3 < CW ≤ 3.3	3.0	25	25	150	25	25.2
MGHR/L2525M3333	★	●		1.25	1.2					
				1.45	1.5					
MGHR/L2020K4315	●	●	MGTR/L 43125   43470	1.25	1.2 (2.0)*	20	20	125	20	20.2
MGHR/L2020K4323	●	●		1.45	1.5					
MGHR/L2020K4333	●	●		1.5 ≤ CW ≤ 2.3	3.0 (3.5)*					
MGHR/L2525M4315	●	●		2.3 < CW ≤ 3.3	4.5 (4.0)*	25	25	150	25	25.2
MGHR/L2525M4323	●	●		3.3 < CW ≤ 4.7 (4.0)*	4.5 (5.0)*					
MGHR/L2525M4333	★	●		1.25	1.2 (2.0)*					
MGHR/L2525M4447	●	●	MGTR/L 44500   44600	1.45	1.5	25	25	150	25	25.2
				1.5 ≤ CW ≤ 2.3	3.0 (3.5)*					
			2.3 < CW ≤ 3.3	4.5 (4.0)*	25	25	150	25	25.2	
			3.3 < CW ≤ 4.7 (4.0)*	4.5 (5.0)*						

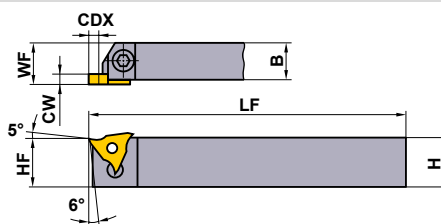
\* Abmessungen bei Installation der CBN-Schneidplatte.

## ERSATZTEILE

Bestellbezeichnung		 *		
MGHR/L2020K3315   MGHR/L2525M4447	MTK1R/L	HBH06020	MES3	HKY40R

\* Spannmoment (N · m) : HBH06020=7.0

## SCHNITTDATENEMPFEHLUNG

Werkstoff	Härte	Sorte	Schnittgeschw. (m/min)	Vorschub (mm/U.)
P C-Stahl Legierter Stahl	180–280HB	VP20MF	120 (100–140)	0.14 (0.03–0.25)
		NX2525	130 (100–160)	0.12 (0.03–0.2)
M Rostfreier Stahl	≤200HB	VP20MF	120 (100–140)	0.12 (0.03–0.18)
K Grauguss	Zugfestigkeit ≤350MPa	VP20MF	120 (100–140)	0.12 (0.03–0.18)

Hinweis 1) Für schmale Einstiche bitte den Vorschub nochmals reduzieren.

● : Lagerstandard. ★ : Lagerstandard in Japan.

(10 WSP je VPE) (CBN-WSP erhältlich in 1 WSP je VPE.)

# WSP

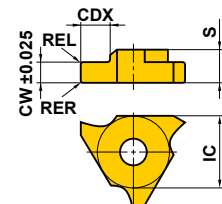
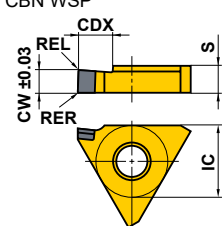
Bestellbezeichnung	Lager						Abmessungen (mm)					Abbildung
	Beschichtet		Cermet		Hartmetall		CW	CDX	IC	S	RER/L	
	VP20MF		NX2525		UT120T							
	R	L	R	L	R	L						
MGTR/L33125	★	★	★		●	●	1.25	1.2	9.525	4.76	0.2	 <p>Abb. zeigt rechte WSP.</p> <p>CBN WSP</p>  <p>WSP nur in Rechtsausführung. ★RER=0.2 REL=0.2</p>
MGTR/L33145	★	★	★		●	★	1.45	1.5	9.525	4.76	0.2	
MGTR/L33150	★	★	★	★	●	●	1.5	3	9.525	4.76	0.2	
MGTR/L33175	★	★	★	★	●	●	1.75	3	9.525	4.76	0.2	
MGTR/L33200	★	★	★	★	●	●	2	3	9.525	4.76	0.2	
MGTR/L33230	★	★			●	●	2.3	3	9.525	4.76	0.2	
MGTR/L33250	★	★	★	★	●	●	2.5	3	9.525	4.76	0.3	
MGTR/L33270	★	★			●	★	2.7	3	9.525	4.76	0.3	
MGTR/L33280	★	★			●	★	2.8	3	9.525	4.76	0.3	
MGTR/L33300	★	★	★	★	●	●	3	3	9.525	4.76	0.3	
MGTR/L33320	★	★			●		3.2	3	9.525	4.76	0.3	
MGTR/L33330		★			●	★	3.3	3	9.525	4.76	0.3	
MGTR/L33350	★	★	★		●	★	3.5	3	9.525	4.76	0.3	
MGTR/L33400	★	★	★	★	●	●	4	3	9.525	4.76	0.3	
MGTR/L43125	★	★	★	★	●	●	1.25	1.2	12.7	4.76	0.2	
MGTR/L43145	★	★		★	●	★	1.45	1.5	12.7	4.76	0.2	
MGTR/L43150	★	★	★	●	●	●	1.5	3	12.7	4.76	0.2	
MGTR/L43175	★	★	★	★	●	●	1.75	3	12.7	4.76	0.2	
MGTR/L43200	★	★	★	●	●	●	2	3	12.7	4.76	0.2	
MGTR/L43230	★	★	●	★	●	●	2.3	3	12.7	4.76	0.2	
MGTR/L43250	★	★	★	★	●	●	2.5	4.5	12.7	4.76	0.3	
MGTR/L43260	★	★	★		●	●	2.6	4.5	12.7	4.76	0.3	
MGTR/L43270	★	★			●	★	2.7	4.5	12.7	4.76	0.3	
MGTR/L43280		★		★	●	●	2.8	4.5	12.7	4.76	0.3	
MGTR/L43300	★	★	★	★	●	●	3	4.5	12.7	4.76	0.3	
MGTR/L43320	★				●	●	3.2	4.5	12.7	4.76	0.3	
MGTR/L43330		★		★	●	●	3.3	4.5	12.7	4.76	0.3	
MGTR/L43350	★	★	★	★	●	●	3.5	4.5	12.7	4.76	0.3	
MGTR/L43400	★	★	★		●	●	4	4.5	12.7	4.76	0.3	
MGTR/L43420	★	★	★		●	●	4.2	4.5	12.7	4.76	0.4	
MGTR/L43430	★	★	★		●	●	4.3	4.5	12.7	4.76	0.4	
MGTR/L43450	★	★	●	★	●	●	4.5	4.5	12.7	4.76	0.4	
MGTR/L43470	★	★	★	★	●	★	4.7	4.5	12.7	4.76	0.4	
MGTR/L44500	★	★			●	★	5	4.5	12.7	6.35	0.4	
MGTR/L44550	★				●		5.5	4.5	12.7	6.35	0.4	
MGTR/L44600	★				●	●	6	4.5	12.7	6.35	0.4	

T

EINSTECHEN / ABSTECHEN

# MICRO-MINI

- Hartmetallausführung für Durchmesser ab 3.2 mm.
- l/d ist 5x Durchmesser.
- Für einen größeren Anwendungsbereich kann die WSP geschliffen werden.
- Breites Anwendungsgebiet inkl. Gewindestechen und Gewindeschneiden.

## MICRO-MINI STANDARD (VOLLHARTMETALLBOHRSTANGEN)

Bestellbezeichnung	Lager	Abmessungen (mm)						Abbildung
	TF15	CW	DCON	LF	LDRED	DMIN*	WF2	
C03FR-BLS	★	2.0	3	80	15	3.2	1.0	
C04FR-BLS	★	2.5	4	80	20	4.2	1.5	
C05HR-BLS	★	3.0	5	100	25	5.2	2.0	

\* DMIN : Min. Stechdurchmesser

## SCHNITTDATENEMPFEHLUNGEN

	Werkstoff	Schnittgeschw. (m/min)	Vorschub (mm/U.)	Schnitttiefe (mm)	Auskragung (l/d)	Schneidkante	
						Eckenradius oder BCH *	Verfasung *
P	C-Stahl, Leg. Stahl 180–280HB	40 (30–50)	0.05 (–0.1)	0.2 (0.1–0.3)	5	0.1–0.5	0.01–0.05
M	Rostfreier Stahl ≤200HB	40 (30–50)	0.05 (–0.1)	0.2 (0.1–0.3)	5	≤0.4	≤0.03 (nicht unbedingt notwendig)
K	Grauguss ≤350MPa	40 (30–50)	0.05 (–0.05)	0.2 (0.1–0.3)	5	0.1–0.5	0.01–0.05
N	Non-Ferrous Metal	80 (60–100)	0.05 (–0.1)	0.3 (0.1–0.5)	5	0.1–0.5	≤0.03 (nicht unbedingt notwendig)

\* Schneidkante ist nicht verfasst. Bitte verfasen Sie die Schneidkante je nach Anwendungsfall vor dem Einsatz.

## ■ SCHLEIFEN DER MICRO-MINI

- MICRO-MINI können im Lieferzustand für Ausdrehen und Einstechen verwendet werden. Sie können aber auch entsprechend der unteren Abbildungen neu geschliffen werden.
- Zur Formgebung und Nachschleifen benutzen Sie eine Diamantscheibe #250–#400. Schleifen Sie je nach Anwendung entsprechend den Abbildungen.

Anwendung	Ausdrehen	Einstechen	Gewindedrehen

● : Lagerstandard. ★ : Lagerstandard in Japan.

(MICRO MINI ist als Einzelverpackung erhältlich.) (MICRO MINI TWIN ist als Einzelverpackung erhältlich.)



# MICRO-MINI TWIN

## ■ Variante CG (Inneneinstechen)

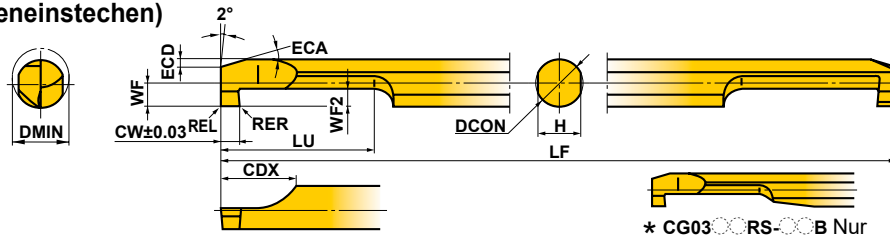

Bestellbezeichnung	Lager		Spanbrecher	Abmessungen (mm)												
	Hartmetall	Beschichtet		DMIN	CW	WF2	RER/L	DCON	LF	LU	CDX	WF	H	ECA	ECD	
	TF15	VP15TF														
CG0305RS-10	★	●	Ohne	3	1	1	0.05	3	50	5	6	1.3	2.7	15°	0.3	
CG0305RS-10B	★	★	Mit	3	1	1	0.05	3	50	5	6	1.3	2.7	15°	0.3	
CG0306RS-20	★	★	Ohne	3	2	1	0.1	3	50	6	6	1.3	2.7	15°	0.3	
CG0306RS-20B	★	★	Mit	3	2	1	0.1	3	50	6	6	1.3	2.7	15°	0.3	
CG03RS-10	★	●	Ohne	3	1	1	0.05	3	50	10	6	1.3	2.7	15°	0.3	
CG03RS-10B	★	★	Mit	3	1	1	0.05	3	50	10	6	1.3	2.7	15°	0.3	
CG03RS-20	★	★	Ohne	3	2	1	0.1	3	50	11	6	1.3	2.7	15°	0.3	
CG03RS-20B	★	★	Mit	3	2	1	0.1	3	50	11	6	1.3	2.7	15°	0.3	
CG0407RS-10	★	★	Ohne	4	1	1.5	0.05	4	60	7	7	1.8	3.6	15°	0.5	
CG0407RS-10B	★	★	Mit	4	1	1.5	0.05	4	60	7	7	1.8	3.6	15°	0.5	
CG0408RS-20	★	★	Ohne	4	2	1.5	0.1	4	60	8	7	1.8	3.6	15°	0.5	
CG0408RS-20B	★	★	Mit	4	2	1.5	0.1	4	60	8	7	1.8	3.6	15°	0.5	
CG04RS-10	★	●	Ohne	4	1	1.5	0.05	4	60	15	7	1.8	3.6	15°	0.5	
CG04RS-10B	★	★	Mit	4	1	1.5	0.05	4	60	15	7	1.8	3.6	15°	0.5	
CG04RS-20	★	★	Ohne	4	2	1.5	0.1	4	60	16	7	1.8	3.6	15°	0.5	
CG04RS-20B	★	●	Mit	4	2	1.5	0.1	4	60	16	7	1.8	3.6	15°	0.5	
CG0510RS-10	★	●	Ohne	5	1	2	0.05	5	70	10	8	2.3	4.5	15°	0.7	
CG0510RS-10B	★	●	Mit	5	1	2	0.05	5	70	10	8	2.3	4.5	15°	0.7	
CG0511RS-20	★	●	Ohne	5	2	2	0.1	5	70	11	8	2.3	4.5	15°	0.7	
CG0511RS-20B	★	★	Mit	5	2	2	0.1	5	70	11	8	2.3	4.5	15°	0.7	
CG05RS-10	★	●	Ohne	5	1	2	0.05	5	70	20	8	2.3	4.5	15°	0.7	
CG05RS-10B	★	★	Mit	5	1	2	0.05	5	70	20	8	2.3	4.5	15°	0.7	
CG05RS-20	●	★	Ohne	5	2	2	0.1	5	70	21	8	2.3	4.5	15°	0.7	
CG05RS-20B	★	●	Mit	5	2	2	0.1	5	70	21	8	2.3	4.5	15°	0.7	
CG0610RS-10	★	●	Ohne	6	1	2	0.05	6	75	10	8	2.8	5.4	15°	0.7	
CG0610RS-10B	★	●	Mit	6	1	2	0.05	6	75	10	8	2.8	5.4	15°	0.7	
CG0611RS-20	★	●	Ohne	6	2	2	0.1	6	75	11	8	2.8	5.4	15°	0.7	
CG0611RS-20B	★	●	Mit	6	2	2	0.1	6	75	11	8	2.8	5.4	15°	0.7	
CG06RS-10	★	●	Ohne	6	1	2	0.05	6	75	20	8	2.8	5.4	15°	0.7	
CG06RS-10B	●	●	Mit	6	1	2	0.05	6	75	20	8	2.8	5.4	15°	0.7	
CG06RS-20	★	●	Ohne	6	2	2	0.1	6	75	21	8	2.8	5.4	15°	0.7	
CG06RS-20B	●	●	Mit	6	2	2	0.1	6	75	21	8	2.8	5.4	15°	0.7	
CG0712RS-10	★	●	Ohne	7	1	2	0.05	7	85	12	8	3.3	6.4	15°	0.7	
CG0712RS-10B	★	●	Mit	7	1	2	0.05	7	85	12	8	3.3	6.4	15°	0.7	
CG0713RS-20	★	★	Ohne	7	2	2	0.1	7	85	13	8	3.3	6.4	15°	0.7	
CG0713RS-20B	★	★	Mit	7	2	2	0.1	7	85	13	8	3.3	6.4	15°	0.7	
CG07RS-10	★	★	Ohne	7	1	2	0.05	7	85	25	8	3.3	6.4	15°	0.7	
CG07RS-10B	★	●	Mit	7	1	2	0.05	7	85	25	8	3.3	6.4	15°	0.7	
CG07RS-20	★	●	Ohne	7	2	2	0.1	7	85	26	8	3.3	6.4	15°	0.7	
CG07RS-20B	●	●	Mit	7	2	2	0.1	7	85	26	8	3.3	6.4	15°	0.7	

EINSTECHEN / ABSTECHEN

# MICRO-MINI TWIN

## SCHNITTDATENEMPFEHLUNG

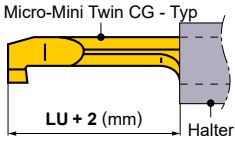
Werkstoff	Härte	Schnittgeschw. (m/min)	Vorschub (mm/U.)		Empfohlene Werkzeugauskrantung (mm)
			CG03RS/CG04RS	CG05RS/CG06RS/CG07RS	
<b>P</b> C-Stahl, Leg. Stahl	180–280HB	80 (40–120)	0.02 (0.01–0.03)	0.03 (0.01–0.05)	
<b>M</b> Rostfreier Stahl	≤200HB	80 (40–120)	0.02 (0.01–0.03)	0.03 (0.01–0.05)	
<b>K</b> Grauguss	Zugfestigkeit ≤350MPa	80 (40–120)	0.03 (0.01–0.05)	0.03 (0.01–0.05)	
<b>N</b> Nicht-Eisen Metalle	–	120 (80–160)	0.03 (0.01–0.05)	0.05 (0.01–0.08)	

Hinweis 1) Bearbeitung mit Kühlschmierstoff wird empfohlen.

### HINWEISE FÜR DEN EINSATZ VON MICRO-MINI BOHRSTANGEN

● Einsatz des Halters bei allgemeiner Bearbeitung / kleine Drehautomaten:

- 1 Setzen Sie die Bohrstange vorsichtig in den Halter ein, um einen Bruch der zweiten Schneidkante zu vermeiden!  
 Zu Bild 1 : Bei Kontakt der Bohrstange mit der Innenfläche des Halters kann es zu Ausbrüchen kommen.

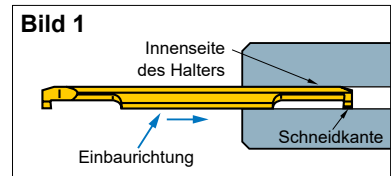

- 2 Beim spannen der Bohrstange im Halter kann es zu Beschädigungen der Bohrstange bzw. der zweiten Schneidkante kommen. Spannen Sie die Schrauben mit dem vorgegeben Anziehmoment. Achten Sie darauf, dass keine Spannschraube nahe der zweiten Schneidkante ist, da diese brechen könnte.

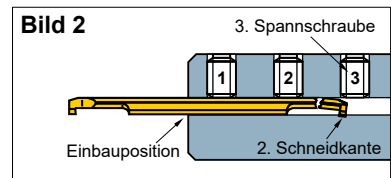

- 3 Beim Einsatz des Mitsubishi Halters und einer Auskrantung von 5xD entfernen Sie bitte die 3. Spannschraube. (Bei RBH1620N, RBH1920N gibt es keine 3. Spannschraube). Das Anziehmoment für diese Schrauben ist 2.0N•m.

● Beim Einsatz des Vierkanthalters :

- 1 Beim Einbau der Bohrstange in den Halter achten Sie darauf, dass die MICRO-MINI-Bohrstange an der Referenzfläche anliegt.  
 2 Versichern Sie sich, dass die Spannschrauben gespannt sind. Die empfohlenen Anziehmomente sind in der Tabelle der Standard Bohrstange zu finden. Ziehen Sie die Spannschrauben richtig an, andernfalls kann eine feste Spannung nicht garantiert werden.  
 3 Spannen Sie die Spannschraube nicht ohne Bohrstange, andernfalls kann es zur Verformung der Spannbrücke kommen.

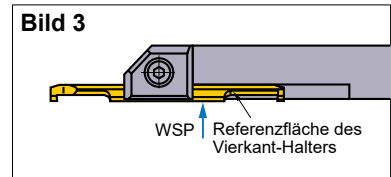

# RUNDE AUSFÜHRUNG

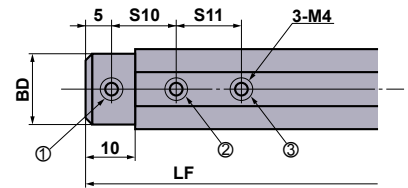
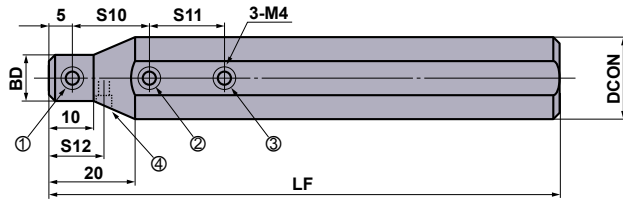

RBH22...N weist eine temporäre Stellschraube für verschiedene Bearbeitungsspezifikationen auf. (Durch die Nummer 4 repräsentiert)

RBH158...N, RBH16...N, RBH190...N

Bestellbezeichnung	Laget	Abmessungen (mm)							MICRO-MINI C	MICRO-MINI TWIN CG	*1 Spannschraube				Schlüssel	Drehmoment (N • m)
		DCON	DCONWS	BD	LF	S10	S11	S12			①	②	③	④		
RBH15820N	★	15.875	2	15	100	10	—	—	—	B	B	—	—	HKY20F	2.0	
RBH15830N	★	15.875	3	15	100	10	10	—	03FR-BLS	A	A	A	—	HKY20F	2.0	
RBH15840N	★	15.875	4	15	100	15	15	—	04FR-BLS	A	A	A	—	HKY20F	2.0	
RBH15850N	★	15.875	5	15	100	15	15	—	05HR-BLS	A	A	A	—	HKY20F	2.0	
RBH15860N	★	15.875	6	15	100	15	15	—	—	A	A	A	—	HKY20F	2.0	
RBH15870N	★	15.875	7	15	100	20	20	—	—	A	A	A	—	HKY20F	2.0	
RBH15880N	★	15.875	8	15	100	20	20	—	—	D	D	D	—	HKY20F	2.0	
RBH1620N	●	16	2	15	100	10	—	—	—	B	B	—	—	HKY20F	2.0	
RBH1630N	●	16	3	15	100	10	10	—	03FR-BLS	A	A	A	—	HKY20F	2.0	
RBH1640N	●	16	4	15	100	15	15	—	04FR-BLS	A	A	A	—	HKY20F	2.0	
RBH1650N	●	16	5	15	100	15	15	—	05HR-BLS	A	A	A	—	HKY20F	2.0	
RBH1660N	●	16	6	15	100	15	15	—	—	A	A	A	—	HKY20F	2.0	
RBH1670N	●	16	7	15	100	20	20	—	—	A	A	A	—	HKY20F	2.0	
RBH1680N	★	16	8	15	100	20	20	—	—	D	D	D	—	HKY20F	2.0	
RBH19020N	★	19.05	2	18	125	10	—	—	—	C	C	—	—	HKY20F	2.0	
RBH19030N	★	19.05	3	18	125	10	10	—	03FR-BLS	B	B	B	—	HKY20F	2.0	
RBH19040N	★	19.05	4	18	125	15	15	—	04FR-BLS	B	B	B	—	HKY20F	2.0	
RBH19050N	★	19.05	5	18	125	15	15	—	05HR-BLS	B	B	B	—	HKY20F	2.0	
RBH19060N	★	19.05	6	18	125	15	15	—	—	B	B	B	—	HKY20F	2.0	
RBH19070N	★	19.05	7	18	125	20	20	—	—	B	B	B	—	HKY20F	2.0	
RBH19080N	★	19.05	8	18	125	20	20	—	—	A	A	A	—	HKY20F	2.0	
RBH2020N	★	20	2	11	125	10	—	—	—	A	A	—	—	HKY20F	2.0	
RBH2030N	★	20	3	12	125	10	10	—	03FR-BLS	A	A	B	—	HKY20F	2.0	
RBH2040N	★	20	4	13	125	15	15	—	04FR-BLS	A	B	B	—	HKY20F	2.0	
RBH2050N	★	20	5	14	125	15	15	—	05HR-BLS	A	B	B	—	HKY20F	2.0	
RBH2060N	★	20	6	15	125	15	15	—	—	A	B	B	—	HKY20F	2.0	
RBH2070N	★	20	7	16	125	20	20	—	—	A	B	B	—	HKY20F	2.0	
RBH2080N	★	20	8	17	125	20	20	—	—	A	A	A	—	HKY20F	2.0	
RBH2220N	★	22	2	11	125	10	—	10	—	A	B	—	A	HKY20F	2.0	
RBH2230N	★	22	3	12	125	10	10	10	03FR-BLS	A	B	C	A	HKY20F	2.0	
RBH2240N	★	22	4	13	125	15	15	12.5	04FR-BLS	A	B	B	A	HKY20F	2.0	
RBH2250N	★	22	5	14	125	15	15	12.5	05HR-BLS	A	B	B	A	HKY20F	2.0	
RBH2260N	★	22	6	15	125	15	15	15	—	A	B	B	A	HKY20F	2.0	
RBH2270N	★	22	7	16	125	20	20	15	—	A	B	B	A	HKY20F	2.0	
RBH2280N	★	22	8	17	125	20	20	15	—	A	B	B	A	HKY20F	2.0	
RBH2520N	★	25	2	11	150	10	—	—	—	A	B	—	—	HKY20F	2.0	
RBH2530N	★	25	3	12	150	10	10	—	03FR-BLS	A	B	C	—	HKY20F	2.0	
RBH2540N	★	25	4	13	150	15	15	—	04FR-BLS	A	C	C	—	HKY20F	2.0	
RBH2550N	★	25	5	14	150	15	15	—	05HR-BLS	A	C	C	—	HKY20F	2.0	
RBH2560N	★	25	6	15	150	15	15	—	—	A	C	C	—	HKY20F	2.0	
RBH2570N	★	25	7	16	150	20	20	—	—	A	C	C	—	HKY20F	2.0	
RBH2580N	★	25	8	17	150	20	20	—	—	A	B	B	—	HKY20F	2.0	
RBH25420N	★	25.4	2	11	150	10	—	—	—	A	B	—	—	HKY20F	2.0	
RBH25430N	★	25.4	3	12	150	10	10	—	03FR-BLS	A	B	C	—	HKY20F	2.0	
RBH25440N	★	25.4	4	13	150	15	15	—	04FR-BLS	A	C	C	—	HKY20F	2.0	
RBH25450N	★	25.4	5	14	150	15	15	—	05HR-BLS	A	C	C	—	HKY20F	2.0	
RBH25460N	★	25.4	6	15	150	15	15	—	—	A	C	C	—	HKY20F	2.0	
RBH25470N	★	25.4	7	16	150	20	20	—	—	A	C	C	—	HKY20F	2.0	
RBH25480N	★	25.4	8	17	150	20	20	—	—	A	B	B	—	HKY20F	2.0	

\*1 Bestellbezeichnung der Spannschrauben: A=HSS04004, B=HSS04006, C=HSS04008

## VIERKANT AUSFÜHRUNG

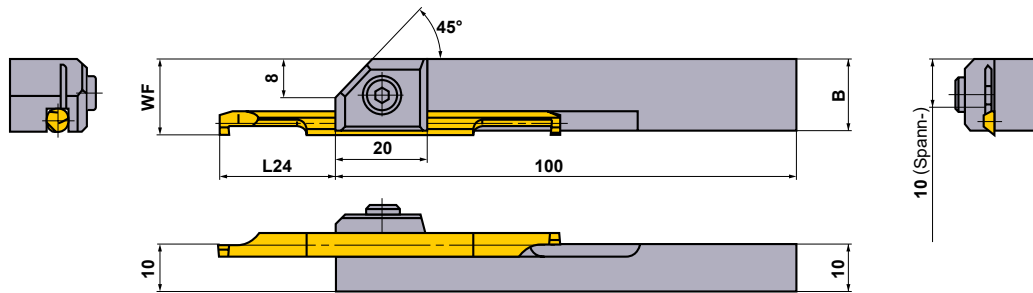

Bestellbezeichnung	Lager	Abmessungen (mm)				MICRO-MINI TWIN CG	Spann- schraube	Schlüssel	Dreh- moment (N · m)
		MICRO-MINI TWIN CG							
		B	WF	L24 *					
						Schneidkantenbreite 1mm	Schneidkantenbreite 2mm		
<b>SBH1030R</b>	★	13.8	13.8	13–17.5 (14)	14–16.5 (15)	03RS-10(B),03RS-20(B)	HSC05012	HKY40R	9.5
<b>SBH1040R</b>	★	14.7	14.8	18–22.5 (19)	19–21.5 (20)	04RS-10(B),04RS-20(B)	HSC05012	HKY40R	9.5
<b>SBH1050R</b>	★	15.6	15.8	23–27.5 (24)	24–26.5 (25)	05RS-10(B),05RS-20(B)	HSC05012	HKY40R	9.5
<b>SBH1060R</b>	★	16.5	16.8	23–32.5 (24)	24–31.5 (25)	06RS-10(B),06RS-20(B)	HSC05012	HKY40R	9.5
<b>SBH1070R</b>	★	17.4	17.8	28–38 (29)	29–37 (30)	07RS-10(B),07RS-20(B)	HSC05012	HKY40R	9.5

\* L24 = Auskraglänge für ausreichende Klemmung. ( ) = Auskraglänge für die allgemeine Bearbeitung in Stahl.  
Hinweis 1) Der MICRO-DEC und der MICRO-MINI passen nicht in rechteckige Aufnahmen.

# Notizen

---

A series of horizontal dashed lines for writing notes, spanning the width of the page.

# ALLGEMEINE ERKLÄRUNG: DREHEN GEWINDEWERKZEUGE

● Wie sind die Seiten dieses Kapitels aufgebaut

- ① Aufgelistet nach externer und interner Anwendung.
  - ② Untergruppen aufgeteilt nach Produkt Serien.
- (Beachten Sie bitte das Inhaltsverzeichnis auf der nächsten Seite.)

**DIE ABBILDUNG ZEIGT DEN ANWENDUNGSBEREICH**  
Die Abbildung und die Bearbeitungspfeile beschreiben die möglichen Bearbeitungsarten Aussengewinde und Innengewindedrehen.

**HALTERAUSFÜHRUNG**  
Die ersten Buchstaben der Bestellbezeichnung und des Anwendungsbereichs werden gezeigt.

**PRODUKTNAME**      **AUSSEN- ODER INNENBEARBEITUNG**

**PRODUKT KAPITEL**      **PRODUKT EIGENSCHAFTEN**

**INNENGEWINDE DREHEN**

**MMTI AUSFÜHRUNG BOHRSTANGEN**

**MMTI**

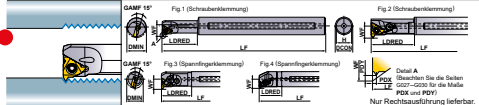

Bestellbezeichnung	WSP	Abmessungen (mm)	WSP	Abmessungen (mm)
MMTR1516AK11-SP15	1.5	16	1.5	16
MMTR1516AK11-SP25	2.5	16	2.5	16
MMTR1516AK11-SP35	3.5	16	3.5	16
MMTR1516AM11-SP15	1.5	16	1.5	16
MMTR1516AM11-SP25	2.5	16	2.5	16
MMTR1516AM11-SP35	3.5	16	3.5	16
MMTR1516AM16-SP15	1.5	16	1.5	16
MMTR1516AM16-SP25	2.5	16	2.5	16
MMTR1516AM16-SP35	3.5	16	3.5	16
MMTR2420AQ16-C	1.5	20	1.5	20
MMTR2420AQ16-C	2.5	20	2.5	20
MMTR2420AQ16-C	3.5	20	3.5	20
MMTR2420AQ22-SP15	1.5	20	1.5	20
MMTR2420AQ22-SP15	2.5	20	2.5	20
MMTR2420AQ22-SP15	3.5	20	3.5	20
MMTR2420AQ22-C	1.5	20	1.5	20
MMTR2420AQ22-C	2.5	20	2.5	20
MMTR2420AQ22-C	3.5	20	3.5	20
MMTR3025AS22-C	1.5	30	1.5	30
MMTR3025AS22-C	2.5	30	2.5	30
MMTR3025AS22-C	3.5	30	3.5	30
MMTR4640AZ2-C	1.5	40	1.5	40
MMTR4640AZ2-C	2.5	40	2.5	40
MMTR4640AZ2-C	3.5	40	3.5	40

Bemerkung 1) Ersatzteile werden in Untergruppen (Separate Bestellung) in Abhängigkeit des Anstellensortes.  
\* Halter mit alterer Schraubklemmung verwenden keine Unterlegplatten. Bitte bestellen Sie einen Halter mit entsprechendem Anstellensort.  
\* Der minimale Bearbeitungsdurchmesser (DMIN) gibt den Innendurchmesser der Bohrung an, nicht den Gewindedurchmesser.  
\* Spannmoment (N·m) : TS25=1.0, CS350800T=3.5, SETS1=3.5, TS43=3.5, SETS1=5.0, HFC03006=1.5, HFC04008=2.2

Werkstoff	WSP	Abmessungen (mm)	WSP	Abmessungen (mm)
Alig. Baustahl	1.5	16	1.5	16
C-Stahl	2.5	16	2.5	16
Lang. Stahl	3.5	16	3.5	16
Rostfreier Stahl	1.5	16	1.5	16
Grauguss	1.5	16	1.5	16

Werkstoff	WSP	Abmessungen (mm)	WSP	Abmessungen (mm)
Alig. Baustahl	1.5	16	1.5	16
C-Stahl	2.5	16	2.5	16
Lang. Stahl	3.5	16	3.5	16
Rostfreier Stahl	1.5	16	1.5	16
Grauguss	1.5	16	1.5	16

● Lagerstandard. \* : Lagerstandard in Japan.  
AUSWAHL DER UNTERLEGEPLATTE → G012  
SERIE BEZUGSNUMMER FÜR WERKSTOFFE → G016

**INFORMATION ÜBER VERFÜGBARE WSP**  
Zeigt Lagerstatus, Abmessungen, etc. für verfügbare WSP an.

## MMT WSP DER KLASSE M MIT 3D-SPANBRECHERN

Form	Bestellbezeichnung	WSP	Steigung	IC	S	PDY	PDX	RE	Quantität	Abbildung
Teilprofil	MMT11RA60-S	1.5	0.5-1.5	48-16	6.35	3.04	0.8	0.9	0.03	Teilprofil
	MMT16RA60-S	1.5	0.5-1.5	48-16	9.525	3.44	0.8	0.9	0.03	Teilprofil
	MMT16RG60-S	1.5	1.75-3.0	14-B	9.525	3.44	1.2	1.7	0.11	Teilprofil
Teilprofil	MMT11RA55-S	1.5	0.5-1.5	48-16	6.35	3.04	0.8	0.9	0.07	Teilprofil
	MMT16RA55-S	1.5	0.5-1.5	48-16	9.525	3.44	0.8	0.9	0.07	Teilprofil
	MMT16RG55-S	1.5	1.75-3.0	14-B	9.525	3.44	1.2	1.7	0.21	Teilprofil
Mittelnach ISO	MMT11R10ISO-S	1.0	1.0	6.35	3.04	0.6	0.7	0.06	0.58	Teilprofil
	MMT11R12ISO-S	1.25	1.25	6.35	3.04	0.8	0.9	0.08	0.72	Teilprofil
	MMT11R15ISO-S	1.5	1.5	6.35	3.04	0.8	1.0	0.10	0.87	Teilprofil
	MMT16R10ISO-S	1.0	1.0	9.525	3.44	0.6	0.7	0.06	0.58	Teilprofil
	MMT16R12ISO-S	1.25	1.25	9.525	3.44	0.8	0.9	0.08	0.72	Teilprofil
	MMT16R15ISO-S	1.5	1.5	9.525	3.44	0.8	1.0	0.10	0.87	Teilprofil
Mittelnach BSPT	MMT16R20ISO-S	2.0	2.0	9.525	3.44	1.0	1.3	0.13	1.15	Teilprofil
	MMT16R25ISO-S	2.5	2.5	9.525	3.44	1.1	1.5	0.17	1.44	Teilprofil
	MMT16R30ISO-S	3.0	3.0	9.525	3.44	1.1	1.5	0.20	1.73	Teilprofil
Mittelnach BSPT	MMT16R160UN-S	16	16	9.525	3.44	0.9	1.1	0.11	0.92	Teilprofil
	MMT16R140UN-S	14	14	9.525	3.44	0.9	1.2	0.12	1.05	Teilprofil
Mittelnach BSPT	MMT16R120UN-S	12	12	9.525	3.44	1.1	1.4	0.14	1.22	Teilprofil
	MMT16R110W-S	11	11	9.525	3.44	0.8	1.0	0.18	0.86	Teilprofil
Mittelnach BSPT	MMT16R140W-S	14	14	9.525	3.44	1.0	1.2	0.25	1.16	Teilprofil
	MMT16R110W-S	11	11	9.525	3.44	1.1	1.5	0.32	1.48	Teilprofil
Mittelnach BSPT	MMT16R190BSPT-S	19	19	9.525	3.44	0.8	0.9	0.18	0.86	Teilprofil
	MMT16R140BSPT-S	14	14	9.525	3.44	1.0	1.2	0.25	1.16	Teilprofil
	MMT16R110BSPT-S	11	11	9.525	3.44	1.1	1.5	0.32	1.48	Teilprofil

**IDENTIFIKATION**

MMT 16 I R 100 ISO - S

Bestimmung: R Racks, Steigung: 100, Anwendung: I Innen, Gewinde Typ: ISO

Standard Schnitttiefe: G016, Ersatzteile: N001, Technische Daten: P001

**LEGENDE FÜR LAGERSTATUS**  
Wird auf jeder Doppelseite auf der linken Seite gezeigt.

**STANDARDPRODUKTE**  
Listet Bestellbezeichnung, Lagerstatus (rechts/links), Abmessungen, verfügbare WSP und Ersatzteile auf.

**QUERVERWEIS AUF ANDERE SEITEN**  
ERSATZTEILE  
Beinhaltet Querverweise für alle auf dieser Doppelseite aufgeführten Produkte.

**SCHNITTDATENEMPFEHLUNGEN**  
Für jede Werkstoffauswahl werden allgemeine Schnittwerte gemäß der ISO-Klassifizierung nach P, M, K, S und H angezeigt.

# DREHEN

# GEWINDEWERKZEUGE

KLASSIFIKATION (AUSSEN) .....	G002
KLASSIFIKATION (INNEN) .....	G003
QUERVERWEIS GEWINDESTEIGUNG	
AUSSEN .....	G004
INNEN .....	G006
STANDARD GEWINDE UND DAZUGEHÖRIGE WSP / HALTER .....	G008

## STANDARD GEWINDEWERKZEUGE

### MMT-SERIE

EIGENSCHAFTEN .....	G010
SCHNITTDATEN .....	G012
STANDARD SCHNITTTIEFE .....	G014

### AUSSENGEWINDE DREHEN

MMTE HALTER .....	G019
MT HALTER .....	G024

### INNENGEWINDE DREHEN

MMTI-AUSFÜHRUNG BOHRSTANGEN .....	G026
MICRO-MINI TWIN BOHRSTANGEN .....	G031

### \*Alphabetisches Inhaltsverzeichnis

G031	CT
G020	MMT (WSP FÜR AUSSENGEWINDE)
G027	MMT (WSP FÜR INNENGEWINDE)
G019	MMTE
G026	MMTI
G024	MT1
G024	MTH
G025	MTT (WSP FÜR AUSSENGEWINDE)
G033	RBH
G032	SBH





# KLASSIFIKATION (AUSSEN)

Halterbezeichnung	WSP-Form	Eigenschaften	Schaft Maße (H x B x L) (mm)
<b>MMTE Halter</b>   		<ul style="list-style-type: none"> <li>● Verschiedenste WSP-Formen und -Sorten.</li> <li>● Präzisions-WSP.</li> <li>● Verfügbar mit einer Wiper Schneidkantenausführung um eine exakte Gewindeschneidgeometrie zu erhalten.</li> <li>● Veränderung des Neigungswinkels durch Auswechslung der Unterlegplatte.</li> </ul>	12 x 12 x 100 16 x 16 x 100 20 x 20 x 125 25 x 25 x 150 32 x 32 x 170
<b>MT Halter</b>   		<ul style="list-style-type: none"> <li>● Spannfingerklemmung.</li> <li>● Präzisions-WSP.</li> <li>● Positiver Schnitt für beste Schlichtoberfläche.</li> </ul>	16 x 16 x 100 20 x 20 x 125 25 x 25 x 150 32 x 32 x 170
<b>TTAH</b>   		<ul style="list-style-type: none"> <li>● Für die Bearbeitung auf Langdrehautomaten.</li> <li>● Kleine Schaftgrößen: 8mm – 16mm.</li> <li>● Stabiles und vertikales WSP Design.</li> <li>● Spezielle Klemmschraube ermöglicht das Austauschen der WSP direkt an der Maschine.</li> <li>● Ausgezeichnet für die Bearbeitung von Gewinde.</li> <li>● Präzisionsdrehhalter</li> </ul>	8 x 10 x 120 10 x 10 x 120 12 x 12 x 120 16 x 16 x 120
<b>CSVH</b>   		<ul style="list-style-type: none"> <li>● Für die Bearbeitung auf Langdrehautomaten.</li> <li>● Kleine Schaftgrößen: 7mm – 12mm.</li> <li>● Multi-funktional einsetzbar für Längsdrehen, Rückwärtsdrehen, Einstecken sowie Gewindedrehen.</li> <li>● Für die Bearbeitung von kleinen Werkstücken mit geringem Durchmesser.</li> <li>● Präzisionsdrehhalter.</li> </ul>	7 x 7 x 140 8 x 8 x 140 9.5 x 9.5 x 140 10 x 10 x 140 12 x 12 x 140

GEWINDE DREHEN



SMALL TOOLS

G

# KLASSIFIKATION (INNEN)

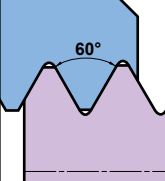
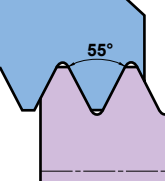
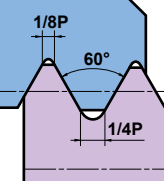
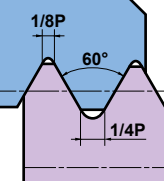
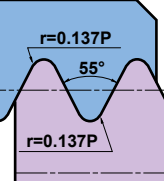
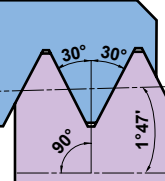

Halterbezeichnung	WSP-Form	Eigenschaften	Schaft Maße (Durchm. x L x min. Durchm.) (mm)
<b>MMTI</b>   		<ul style="list-style-type: none"> <li>● Min. Durchmesser 13mm.</li> <li>● Verschiedenste WSP-Formen und -Sorten.</li> <li>● Präzisions-WSP.</li> <li>● Verfügbar mit einer Wiper Schneidkantenausführung, um eine exakte Gewindegewindegeometrie zu erhalten.</li> <li>● Veränderung des Neigungswinkels durch Auswechslung der Unterlegplatte.</li> </ul>	16 x 125 x 13 16 x 150 x 15 20 x 170 x 24 25 x 200 x 29 32 x 250 x 37 40 x 300 x 46
<b>MICRO-MINI TWIN Bohrstangen</b>  	—	<ul style="list-style-type: none"> <li>● Min. Durchmesser 3mm.</li> <li>● Hartmetallwerkzeug.</li> <li>● Präzisionsdrehhalter.</li> </ul>	3 x 50 x 3 4 x 60 x 4.5 5 x 70 x 6 6 x 75 x 7
<b>MICRO-MINI Bohrstangen</b>  	—	<ul style="list-style-type: none"> <li>● Min. Durchmesser 3.2mm.</li> <li>● Hartmetallwerkzeug.</li> <li>● WSP bekommt durch Anschleifen einen größeren Anwendungsbereich.</li> </ul>	3 x 80 x 3.2 4 x 80 x 4.2 5 x 100 x 5.2

# QUERVERWEIS GEWINDESTEIGUNG (AUSSEN)

Anwendung	Allgemeine Bearbeitung				Rohr Apparaturen und Verbindungen für Gas und Wasser		
Form	Teilprofil 60° 	Teilprofil 55° 	Metrisch ISO 	Gewindeform UN-amerikanisch 	Parallelgewinde für Leitungen Whitworth für BSW,BSP 	Gewindeform NPT-amerikanisch 	
Symbol	M UNC UNF	W	M	UNC UNF	G(PF) Rp(PS) W	NPT	
Steigung	mm (Gang/Zoll)	Gang/Zoll	mm	Gang/Zoll	Gang/Zoll	Gang/Zoll	
Halter							
<b>MMT Halter</b>  G019	Vollprofil	—	—	0.5 – 5.0	32 – 5	28 – 5	27, 18, 14 11.5, 8
	Teilprofil	0.5 – 5.0 (48 – 5)	48 – 5	0.5 – 5.0	48 – 5	—	—
<b>MT Halter</b>  G024	Teilprofil	0.25 – 4.5 (64 – 6)	20 – 9	0.25 – 4.5	64 – 6	—	—

Dampf, Gas- und Wasserleitungen		Für Kupplungen von Lebensmittel- und Feuerbekämpfungsindustrie	Übertragungsbewegung	Luft- und Raumfahrtind.	Oil und Gas		
Rohrgewinde (konisch) BSPT	Gewindeform NPTF-amerikanisch	Rund-DIN 405	ISO Trapez 30°	Gewindeform ACME-amerikanisch	UNJ	API Rohrgewinde	API Gehäuse und Wellen
R(PT) Rc(PT) Rp	NPTF	Rd	Tr (TM)	ACME (Tw)	UNJ	BCSG	CSG LCSG
Gang/Zoll	Gang/Zoll	Gang/Zoll	mm	Gang/Zoll	Gang/Zoll	Gang/Zoll	Gang/Zoll
28, 19 14, 11	27, 18, 14 11.5, 8	10, 8, 6, 4	1.5, 2 3, 4, 5	12, 10 8, 6, 5	32–8	5	10, 8
–	–	–	–	–	–	–	–
–	–	–	–	–	–	–	–

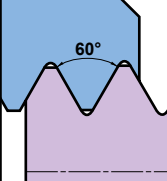
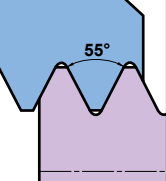
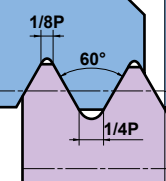
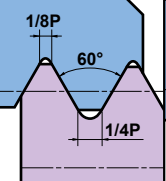
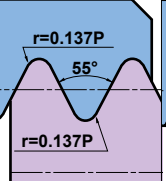
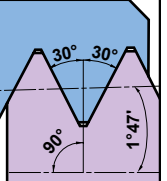
# QUERVERWEIS GEWINDESTEIFUNG (INNEN)

Anwendung	Allgemeine Bearbeitung				Rohr Apparaturen und Verbindungen für Gas und Wasser		
Form	Teilprofil 60° 	Teilprofil 55° 	Metrisch ISO 	Gewindeform UN-amerikanisch 	Parallelgewinde für Leitungen Whitworth für BSW, BSP 	Gewindeform NPT-amerikanisch 	
Symbol	M UNC UNF	W	M	UNC UNF	G(PF) Rp(PS) W	NPT	
Steigung	mm (Gang/Zoll)	Gang/Zoll	mm	Gang/Zoll	Gang/Zoll	Gang/Zoll	
Halter							
<b>MMT Bohrstange</b>  → G026	Vollprofil	—	—	0.5 – 5.0	32 – 5	28 – 5	27, 18, 14 11.5, 8
	Teilprofil	0.5 – 5.0 (48 – 5)	48 – 5	0.5 – 5.0	48 – 5	—	—
<b>MICRO-MINI TWIN</b>  → G031	Teilprofil	0.5 – 1.75 (36 – 16)	—	0.5 – 1.75	36 – 16	—	—

Dampf, Gas- und Wasserleitungen		Für Kupplungen von Lebensmittel- und Feuerbekämpfungsindustrie	Übertragungsbewegung		Luft- und Raumfahrtind.	Oil und Gas	
Rohrgewinde (konisch) BSPT	Gewindeform NPTF-amerikanisch	Rund-DIN 405	ISO Trapez 30°	Gewindeform ACME-amerikanisch	UNJ	API Rohrgewinde	API Gehäuse und Wellen
R(PT) Rc(PT) Rp	NPTF	Rd	Tr (TM)	ACME (Tw)	UNJ	BCSG	CSG LCSG
Gang/Zoll	Gang/Zoll	Gang/Zoll	mm	Gang/Zoll	Gang/Zoll	Gang/Zoll	Gang/Zoll
19, 14, 11	14, 11.5, 8	10, 8 6, 4	1.5, 2 3, 4, 5	12, 10 8, 6, 5	—	5	10, 8
—	—	—	—	—	*	—	—
—	—	—	—	—	—	—	—

\* Bei UNJ Innengewinde drehen Sie bitte den Innendurchmesser vor und verwenden Sie eine 60°UN WSP. In diesem Fall können keine Vollprofil WSP verwendet werden.

# STANDARD GEWINDE UND DAZUGEHÖRIGE WSP / HALTER

Art	Ausführung	Form	Ext./Int.	WSP Bezeichnung	Voll-/Teilprofil	Halterbezeichnung	Seite
Metrisch ISO	<p> <math>H=0.866025P</math> <math>d_2=d-0.649519P</math>  <math>H_1=0.541266P</math> <math>d_1=d-1.082532P</math>  <math>D=d</math> <math>D_2=d_2</math> <math>D_1=d_1</math> </p>	M	Ext.	MMT $\odot\odot$ ER $\odot\odot$ ISO	Vollprofil	MMTER $\odot\odot\odot\odot\odot$ -C	G019
				MMT $\odot\odot$ ER $\odot\odot$ ISO-S	Vollprofil		
				MMT $\odot\odot$ ER $\odot\odot$ 60	Teilprofil		
				MMT $\odot\odot$ ER $\odot\odot$ 60-S	Teilprofil		
			Int.	MTTR/L4360 $\odot\odot$	Teilprofil	MTHR/L $\odot\odot\odot\odot\odot$ 4 MT1R/L $\odot\odot\odot\odot\odot$ 4	G024
				MMT $\odot\odot$ IR $\odot\odot$ ISO	Vollprofil	MMTIR $\odot\odot$ A $\odot\odot\odot$ -SP $\odot$ MMTIR $\odot\odot$ A $\odot$ 16-C	G026
				MMT $\odot\odot$ IR $\odot\odot$ ISO-S	Vollprofil		
				MMT $\odot\odot$ IR $\odot\odot$ 60	Teilprofil		
MMT $\odot\odot$ IR $\odot\odot$ 60-S	Teilprofil						
Gewindeform UN-amerikanisch	<p> <math>H=0.866025 \times 25.4/n</math> <math>d_2=(d-0.649519/n) \times 25.4</math>  <math>H_1=0.541266 \times 25.4/n</math> <math>d_1=(d-1.082532/n) \times 25.4</math>  <math>d=(d) \times 25.4</math> <math>D=d</math> <math>D_2=d_2</math> <math>D_1=d_1</math> <math>P=25.4/\text{Gang}</math> </p>	UNC UNF	Ext.	MMT $\odot\odot$ ER $\odot\odot$ UN	Vollprofil	MMTER $\odot\odot\odot\odot\odot$ -C	G019
				MMT $\odot\odot$ ER $\odot\odot$ UN-S	Vollprofil		
				MMT $\odot\odot$ ER $\odot\odot$ 60	Teilprofil		
				MMT $\odot\odot$ ER $\odot\odot$ 60-S	Teilprofil		
			Int.	MTTR/L4360 $\odot\odot$	Teilprofil	MTHR/L $\odot\odot\odot\odot\odot$ 4 MT1R/L $\odot\odot\odot\odot\odot$ 4	G024
				MMT $\odot\odot$ IR $\odot\odot$ UN	Vollprofil	MMTIR $\odot\odot$ A $\odot\odot\odot$ -SP $\odot$ MMTIR $\odot\odot$ A $\odot$ 16-C	G026
				MMT $\odot\odot$ IR $\odot\odot$ UN-S	Vollprofil		
				MMT $\odot\odot$ IR $\odot\odot$ 60	Teilprofil		
MMT $\odot\odot$ IR $\odot\odot$ 60-S	Teilprofil						
Whitworth für BSW, BSP	<p> <math>H=0.9605P</math> <math>d_2=d-H_1</math> <math>d_1=d-2H_1</math> <math>r=0.1373P</math>  <math>H_1=0.6403P</math> <math>D_1'=d_1+2 \times 0.0769H</math>  <math>D=d</math> <math>D_2=d_2</math> <math>D_1=d_1</math> <math>P=25.4/\text{Gang}</math> </p>	W	Ext.	MMT $\odot\odot$ ER $\odot\odot$ W	Vollprofil	MMTER $\odot\odot\odot\odot\odot$ -C	G019
				MMT $\odot\odot$ ER $\odot\odot$ W-S	Vollprofil		
				MMT $\odot\odot$ ER $\odot\odot$ 55	Teilprofil		
				MMT $\odot\odot$ ER $\odot\odot$ 55-S	Teilprofil		
			Int.	MTTR/L4355 $\odot\odot$	Teilprofil	MTHR/L $\odot\odot\odot\odot\odot$ 4 MT1R/L $\odot\odot\odot\odot\odot$ 4	G024
				MMT $\odot\odot$ IR $\odot\odot$ W	Vollprofil	MMTIR $\odot\odot$ A $\odot\odot\odot$ -SP $\odot$ MMTIR $\odot\odot$ A $\odot$ 16-C	G026
				MMT $\odot\odot$ IR $\odot\odot$ W-S	Vollprofil		
				MMT $\odot\odot$ IR $\odot\odot$ 55	Teilprofil		
MMT $\odot\odot$ IR $\odot\odot$ 55-S	Teilprofil						

Vollprofil : WSP Bezeichnung leitet sich aus der Steigung ab.  
 Teilprofil : Diese WSP sind für verschiedene Gewindesteigungen einsetzbar.



Art	Ausführung	Form	Ext./Int.	WSP Bezeichnung	Voll-/Teilprofil	Halterbezeichnung	Seite
Parallele Rohrgewinde	<p>H=0.960491P d<sub>2</sub>=d-h d<sub>1</sub>=d-2h r=0.137329P h=0.640327 D=d D<sub>2</sub>=d<sub>2</sub> D<sub>1</sub>=d<sub>1</sub> 25.4/ Gang</p>	PF G Rp	Ext.	MMT $\odot\odot$ ER $\odot\odot\odot$ W	Vollprofil	MMTER $\odot\odot\odot\odot\odot\odot$ -C	G019
				MMT $\odot\odot$ ER $\odot\odot\odot$ W-S	Vollprofil		
			Int.	MMT $\odot\odot$ IR $\odot\odot\odot$ W	Vollprofil	MMTIR $\odot\odot$ A $\odot\odot\odot$ -SP $\odot$ MMTIR $\odot\odot$ A $\odot\odot$ 16-C	G026
				MMT $\odot\odot$ IR $\odot\odot\odot$ W-S	Vollprofil		
BSPT	<p>H=0.960237P h=0.640327 r=0.137278P P=25.4/ Gang</p>	BSPT	Ext.	MMT $\odot\odot$ ER $\odot\odot\odot$ BSPT	Vollprofil	MMTER $\odot\odot\odot\odot\odot\odot$ -C	G019
				MMT $\odot\odot$ ER $\odot\odot\odot$ BSPT-S	Vollprofil		
			Int.	MMT $\odot\odot$ IR $\odot\odot\odot$ BSPT	Vollprofil	MMTIR $\odot\odot$ A $\odot\odot\odot$ -SP $\odot$ MMTIR $\odot\odot$ A $\odot\odot$ 16-C	G026
				MMT $\odot\odot$ IR $\odot\odot\odot$ BSPT-S	Vollprofil		
Rund-DIN 405	<p>a<sub>c</sub>=0.05×P h<sub>3</sub>=H<sub>4</sub>=0.5×P R<sub>1</sub>=0.238507×P R<sub>2</sub>=0.255967×P R<sub>3</sub>=0.221047×P</p>	Rd	Ext.	MMT $\odot\odot$ ER $\odot\odot\odot$ RD	Vollprofil	MMTER $\odot\odot\odot\odot\odot\odot$ -C	G019
			Int.	MMT $\odot\odot$ IR $\odot\odot\odot$ RD	Vollprofil	MMTIR $\odot\odot$ A $\odot\odot\odot$ -SP $\odot$ MMTIR $\odot\odot$ A $\odot\odot$ 16-C	G026
ISO Trapez 30°	<p>0.366P 0.366P</p>	Tr	Ext.	MMT $\odot\odot$ ER $\odot\odot\odot$ TR	Vollprofil	MMTER $\odot\odot\odot\odot\odot\odot$ -C	G019
			Int.	MMT $\odot\odot$ IR $\odot\odot\odot$ TR	Vollprofil	MMTIR $\odot\odot$ A $\odot\odot\odot$ -SP $\odot$ MMTIR $\odot\odot$ A $\odot\odot$ 16-C	G026
Gewindeform ACME-amerikanisch	<p>29° 14.5° 14.5°</p>	ACME	Ext.	MMT $\odot\odot$ ER $\odot\odot\odot$ ACME	Vollprofil	MMTER $\odot\odot\odot\odot\odot\odot$ -C	G019
			Int.	MMT $\odot\odot$ IR $\odot\odot\odot$ TACME	Vollprofil	MMTIR $\odot\odot$ A $\odot\odot\odot$ -SP $\odot$ MMTIR $\odot\odot$ A $\odot\odot$ 16-C	G026
Gewindeform NPT-amerikanisch	<p>30° 30° 60° 1.78°</p>	NPT	Ext.	MMT $\odot\odot$ ER $\odot\odot\odot$ NPT	Vollprofil	MMTER $\odot\odot\odot\odot\odot\odot$ -C	G019
			Int.	MMT $\odot\odot$ IR $\odot\odot\odot$ NPT	Vollprofil	MMTIR $\odot\odot$ A $\odot\odot\odot$ -SP $\odot$ MMTIR $\odot\odot$ A $\odot\odot$ 16-C	G026

Vollprofil : WSP Bezeichnung leitet sich aus der Steigung ab.  
Teilprofil : Diese WSP sind für verschiedene Gewindesteigungen einsetzbar.

# MMT HALTER

■ EINE BREITE AUSWAHL AN WSP

Mitsubishi Miracle Threading "Gewindedrehen" (MMT).

M-TOLERANZ WSP MIT 3D GEOMETRIE

G-TOLERANZ WSP

G

GEWINDE DREHEN

■ IDEALE SPANKONTROLLE SELBST BEI DEN MITTLEREN SCHNITTTIEFEN UND BAHNEN. (M-TOLERANZ WSP MIT 3D-GEOMETRIE)

ISO metrische Gewindesteigung 1.5mm letzte Bahn (6 Bahnen)

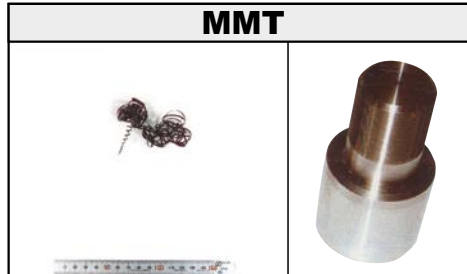

<Schnittdaten>  
 Material : DIN 41CrMo4  
 WSP : MMT16ER150ISO-S  
 Sorte : VP15TF  
 Schnittgeschw. : 120m/min  
 Schnittmethode : Radiale Zustellung  
 Schnitttiefe : Schnittbereich  
 Durchgang : 6 mal  
 Kühlung : Nass

■ HÖHERE PRÄZISION ALS HERKÖMLICHE WSP (G-TOLERANZ WSP)

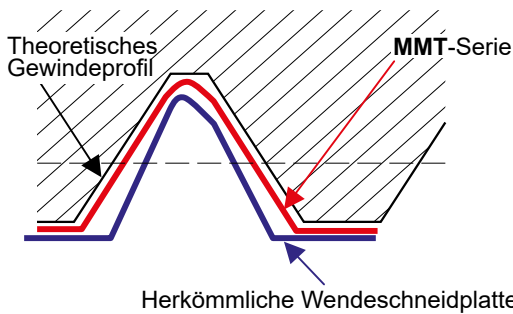

Präzisionsgewinde durch den Einsatz von geschliffenen und profilierten Wendschneidplatten.

Gewindeform	Gewindetoleranz
Metrisch ISO	6g / 6H
Gewindeform UN-amerikanisch	2A / 2B
Whitworth für BSW, BSP	Mittel
BSPT	Standard BSPT
Rund-DIN 405	7h / 7H
ISO Trapez 30°	7e / 7H
Gewindeform ACME-amerikanisch	3G
UNJ	3A
API Rohrgewinde	Standard API
API Gehäuse und Welle	Standard API RD
Gewindeform NPT-amerikanisch	Standard NPT
Gewindeform NPTF-amerikanisch	2. Klasse

## ■ HALTER (Spezielle Oberflächenbehandlung zum Schutz vor Spanschlag und Korrosion)

### Außen

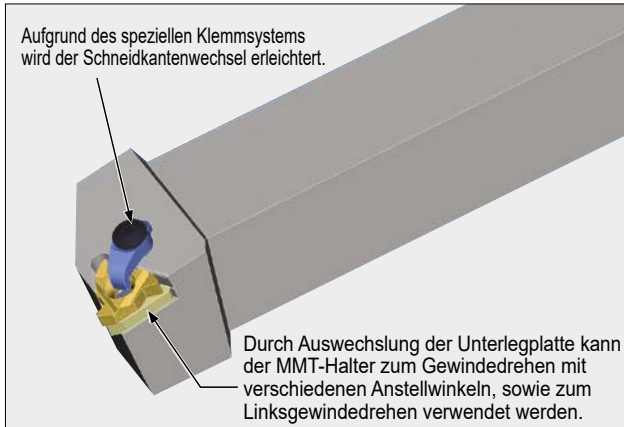

### Innen



★ Bestellbezeichnung der Kühlmittelführungsschraube: TFS03006 (außer MMTIR1316/MMTIR1516)

## ■ GEEIGNET ZUM GEWINDESCHNEIDEN, SOGAR BEI GROSSEM ANSTELLWINKEL

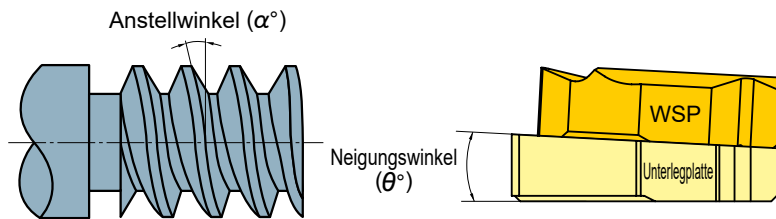

Durch Auswechslung der Unterlegplatte kann der MMT-Halter zum Gewindedrehen mit verschiedenen Steigungswinkeln verwendet werden.

Anstellwinkel ( $\alpha^\circ$ )	Neigungswinkel ( $\theta^\circ$ )
-1.5°	-3°
-0.5°	-2°
0.5°	-1°
1.5°	0°
2.5°	1°
3.5°	2°
4.5°	3°

Standard Unterlegplatte im Lieferumfang des Halters enthalten.

## ■ SORTE

### VP10MF (Nur G-Toleranz WSP)

#### ● Hoher Verschleiß- und Bruchwiderstand

- Für kontinuierliche Gewindebearbeitungen mit hoher Schnittgeschwindigkeit und hoher Präzision.
- G-Toleranz WSP eignen sich ideal für hohe Präzisionsanforderungen beim Gewindedrehen.

### VP15TF (G-Toleranz WSP, M-Toleranz WSP mit 3D-Geometrie)

#### ● Breiter Anwendungsbereich

- Sorte mit guter Balance zwischen Härte und Zähigkeit. Für kontinuierliche sowie unterbrochene Bearbeitungen.
- Hohe Spankontrolle dank des 3D-Spanbrechers.

### VP20RT (M-Toleranz WSP mit 3D-Geometrie)

#### ● Hervorragende Bruchfestigkeit

- Für Bohrungen in rostfreien Stählen und instabilen Bearbeitungen geeignet, wo die Schneidplatten bruchanfällig sind.
- Hohe Spankontrolle dank des 3D-Spanbrechers.

## ■ AUSWAHL DER BENÖTIGTEN WSP (M/G-Toleranz)

WSP	Spankontrolle	Präzision	WSP	Spankontrolle	Präzision
M-Toleranz WSP mit 3D Geometrie 	◎	○	G-Toleranz WSPs 	○	◎

- Für ideale Spankontrolle und hohe Prozesssicherheit werden M-Toleranz Wendeschneidplatten mit 3-D Spanbrechern empfohlen.
- Bei hohen Präzisionsanforderungen werden G-Toleranz WSP empfohlen.

# SCHNITTDATEN DER MMT-SERIE

## WAHL DER UNTERLEGPLATTE FÜR MMT-HALTER

### FLANKENWINKEL UND ANSTELLWINKEL

Der Steigungswinkel ( $\alpha$ ) ergibt sich aus dem Verhältnis aus Durchmesser und Gewindesteigung. Wählen Sie die Unterlegplatte so, dass der Steigungswinkel des Gewindes immer kleiner als der Flankenfreiwinkel ( $\beta_1, \beta_2$ ) ist. Beim größten Teil der Gewindebearbeitung muss, bei Benutzung eines MMT-Halters, keine andere Unterlegplatte gewählt werden. Bei Gewinden mit kleinen Durchmessern oder mit großen Steigungen muss die Unterlegplatte in Abhängigkeit des Steigungswinkels gewählt werden. Bei Linksgewinden muss eine Unterlegplatte mit negativem Neigungswinkel eingesetzt werden.

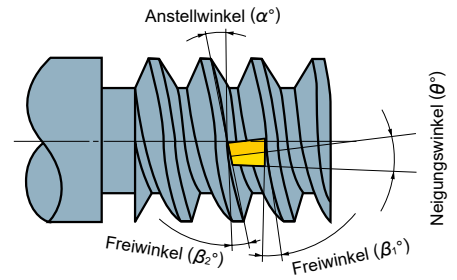

### DARSTELLUNGSTABELLE DER UNTERLEGPLATTE (GEWINDEDURCHMESSER) (Gewindegewinkel 60° und 55°)

Anstellwinkel Steigung (mm)	Rechtsgewinde (mm)						Linksgewinde (mm) *		
	Gewindeschneiden nicht möglich	4.5°	3.5°	2.5°	1.5°	0.5°	Gewindeschneiden nicht möglich	-1.5°	-0.5°
0.5	≤φ1.7	φ1.7 – φ2.3	φ2.3 – φ3.0	φ3.0 – φ4.6	φ4.6 – φ9.1	≥φ9.1	≤φ3.6	φ3.6 – φ9.1	≥φ9.1
0.75	≤φ2.5	φ2.5 – φ3.4	φ3.4 – φ4.6	φ4.6 – φ6.8	φ6.8 – φ13.7	≥φ13.7	≤φ5.5	φ5.5 – φ13.7	≥φ13.7
1	≤φ3.3	φ3.3 – φ4.6	φ4.6 – φ6.1	φ6.1 – φ9.1	φ9.1 – φ18.2	≥φ18.2	≤φ7.3	φ7.3 – φ18.2	≥φ18.2
1.25	≤φ4.1	φ4.1 – φ5.7	φ5.7 – φ7.6	φ7.6 – φ11.4	φ11.4 – φ22.8	≥φ22.8	≤φ9.1	φ9.1 – φ22.8	≥φ22.8
1.5	≤φ5.0	φ5.0 – φ6.8	φ6.8 – φ9.1	φ9.1 – φ13.7	φ13.7 – φ27.4	≥φ27.4	≤φ10.9	φ10.9 – φ27.4	≥φ27.4
1.75	≤φ5.8	φ5.8 – φ8.0	φ8.0 – φ10.6	φ10.6 – φ16.0	φ16.0 – φ31.9	≥φ31.9	≤φ12.8	φ12.8 – φ31.9	≥φ31.9
2	≤φ6.6	φ6.6 – φ9.1	φ9.1 – φ12.1	φ12.1 – φ18.2	φ18.2 – φ36.5	≥φ36.5	≤φ14.6	φ14.6 – φ36.5	≥φ36.5
2.5	≤φ8.3	φ8.3 – φ11.4	φ11.4 – φ15.2	φ15.2 – φ22.8	φ22.8 – φ45.6	≥φ45.6	≤φ18.2	φ18.2 – φ45.6	≥φ45.6
3	≤φ9.9	φ9.9 – φ13.7	φ13.7 – φ18.2	φ18.2 – φ27.3	φ27.3 – φ54.7	≥φ54.7	≤φ21.9	φ21.9 – φ54.7	≥φ54.7
3.5	≤φ11.6	φ11.6 – φ15.9	φ15.9 – φ21.3	φ21.3 – φ31.9	φ31.9 – φ63.8	≥φ63.8	≤φ25.5	φ25.5 – φ63.8	≥φ63.8
4	≤φ13.2	φ13.2 – φ18.2	φ18.2 – φ24.3	φ24.3 – φ36.5	φ36.5 – φ72.9	≥φ72.9	≤φ29.2	φ29.2 – φ72.9	≥φ72.9
4.5	≤φ14.9	φ14.9 – φ20.5	φ20.5 – φ27.3	φ27.3 – φ41.0	φ41.0 – φ82.1	≥φ82.1	≤φ32.8	φ32.8 – φ82.1	≥φ82.1
5	≤φ16.5	φ16.5 – φ22.8	φ22.8 – φ30.4	φ30.4 – φ45.6	φ45.6 – φ91.2	≥φ91.2	≤φ36.5	φ36.5 – φ91.2	≥φ91.2

\* Hinterdrehen bei Linksgewindedrehen.

### GRAFISCHE DARSTELLUNG DER UNTERLEGPLATTE (Gewindegewinkel 60° und 55°)

#### Rechtsgewinde

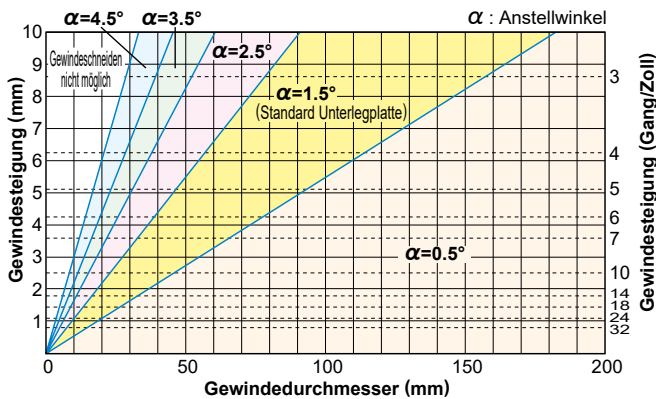

#### Linksgewinde

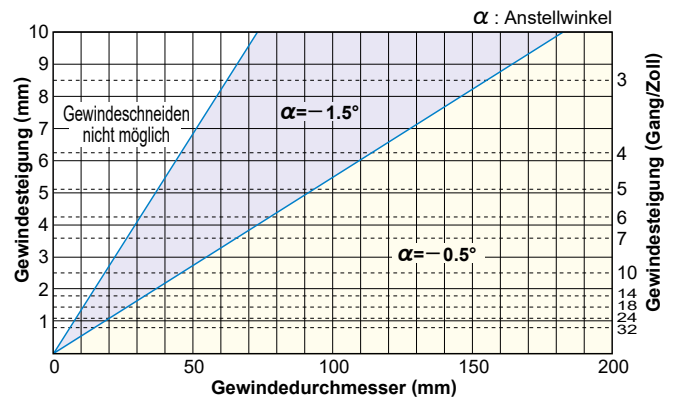

Hinweis: Wenn ein Gewinde-Anstellwinkel ≤ Werkzeugflankenwinkel ist, wechseln Sie die Unterlegplatte, um Seiteninterferenz mit der WSP zu vermeiden. (Berechnung von Gewinde-Anstellwinkel und Werkzeugflankenwinkel: siehe Tabelle auf Seite G013.)

### DARSTELLUNGSTABELLE DER UNTERLEGPLATTE (GEWINDEDURCHMESSER) (Gewindegewinkel 30° und 29°)

Anstellwinkel Steigung (mm)	Rechtsgewinde (mm)						Linksgewinde (mm) *		
	Gewindeschneiden nicht möglich	4.5°	3.5°	2.5°	1.5°	0.5°	Gewindeschneiden nicht möglich	-1.5°	-0.5°
0.5	≤φ1.8	φ1.8 – φ2.3	φ2.3 – φ3.0	φ3.0 – φ4.6	φ4.6 – φ9.1	≥φ9.1	≤φ4.6	φ4.6 – φ9.1	≥φ9.1
0.75	≤φ2.7	φ2.7 – φ3.4	φ3.4 – φ4.6	φ4.6 – φ6.8	φ6.8 – φ13.7	≥φ13.7	≤φ6.8	φ6.8 – φ13.7	≥φ13.7
1	≤φ3.6	φ3.6 – φ4.6	φ4.6 – φ6.1	φ6.1 – φ9.1	φ9.1 – φ18.2	≥φ18.2	≤φ9.1	φ9.1 – φ18.2	≥φ18.2
1.25	≤φ4.5	φ4.5 – φ5.7	φ5.7 – φ7.6	φ7.6 – φ11.4	φ11.4 – φ22.8	≥φ22.8	≤φ11.4	φ11.4 – φ22.8	≥φ22.8
1.5	≤φ5.5	φ5.5 – φ6.8	φ6.8 – φ9.1	φ9.1 – φ13.7	φ13.7 – φ27.4	≥φ27.4	≤φ13.7	φ13.7 – φ27.4	≥φ27.4
1.75	≤φ6.4	φ6.4 – φ8.0	φ8.0 – φ10.6	φ10.6 – φ16.0	φ16.0 – φ31.9	≥φ31.9	≤φ16.0	φ16.0 – φ31.9	≥φ31.9
2	≤φ7.3	φ7.3 – φ9.1	φ9.1 – φ12.1	φ12.1 – φ18.2	φ18.2 – φ36.5	≥φ36.5	≤φ18.2	φ18.2 – φ36.5	≥φ36.5
2.5	≤φ9.1	φ9.1 – φ11.4	φ11.4 – φ15.2	φ15.2 – φ22.8	φ22.8 – φ45.6	≥φ45.6	≤φ22.8	φ22.8 – φ45.6	≥φ45.6
3	≤φ10.9	φ10.9 – φ13.7	φ13.7 – φ18.2	φ18.2 – φ27.3	φ27.3 – φ54.7	≥φ54.7	≤φ27.3	φ27.3 – φ54.7	≥φ54.7
3.5	≤φ12.7	φ12.7 – φ15.9	φ15.9 – φ21.3	φ21.3 – φ31.9	φ31.9 – φ63.8	≥φ63.8	≤φ31.9	φ31.9 – φ63.8	≥φ63.8
4	≤φ14.6	φ14.6 – φ18.2	φ18.2 – φ24.3	φ24.3 – φ36.5	φ36.5 – φ72.9	≥φ72.9	≤φ36.5	φ36.5 – φ72.9	≥φ72.9
4.5	≤φ16.4	φ16.4 – φ20.5	φ20.5 – φ27.3	φ27.3 – φ41.0	φ41.0 – φ82.1	≥φ82.1	≤φ41.0	φ41.0 – φ82.1	≥φ82.1
5	≤φ18.2	φ18.2 – φ22.8	φ22.8 – φ30.4	φ30.4 – φ45.6	φ45.6 – φ91.2	≥φ91.2	≤φ45.6	φ45.6 – φ91.2	≥φ91.2

\* Hinterdrehen bei Linksgewindedrehen.

## GRAFISCHE DARSTELLUNG DER UNTERLEGPLATTE (Gewindegewinkel 30° und 29°)

### Rechtsgewinde

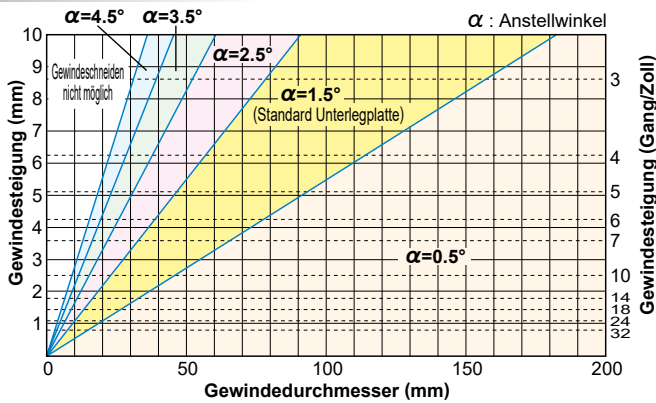

### Linksgewinde

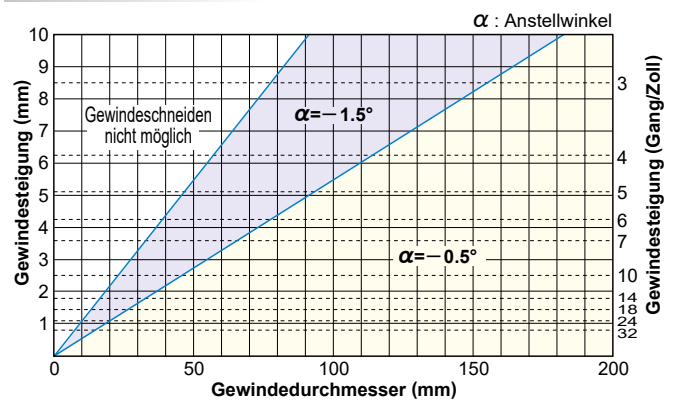

Hinweis: Wenn ein Gewinde-Anstellwinkel  $\leq$  Werkzeugflankenwinkel ist, wechseln Sie die Unterlegplatte, um Seiteninterferenz mit der WSP zu vermeiden. (Berechnung von Gewinde-Anstellwinkel und Werkzeugflankenwinkel siehe Tabelle unten.)

## AUSWAHLTABELLE

Anstellwinkel	Profilwinkel 60°/55° Rechtsausführung Gewinde		Profilwinkel 60°/55° Linksausführung Gewinde *		Profilwinkel 30°/29° Rechtsausführung Gewinde		Profilwinkel 30°/29° Linksausführung Gewinde *	
	P05	P05	N05	N05	P05	P05	N05	N05
0	P05	P05	N05	N05	P05	P05	N05	N05
0.5	P05	P05	N05	N05	P05	P05	N05	N05
1	P15	P15	N15	N15	P15	P15	N15	N15
1.5	P15	P15	N15	N15	P15	P15	N15	N15
2	P25	P25	N15	N15	P25	P25	Kompatibel	Kompatibel
2.5	P25	P25	Kompatibel	Kompatibel	P25	P25	Kompatibel	Kompatibel
3	P35	P35	Kompatibel	Kompatibel	P35	P35	Kompatibel	Kompatibel
3.5	P35	P35	Kompatibel	Kompatibel	P35	P35	Kompatibel	Kompatibel
4	P45	P45	Kompatibel	Kompatibel	P45	P45	Kompatibel	Kompatibel
4.5	P45	P45	Kompatibel	Kompatibel	P45	P45	Kompatibel	Kompatibel
5	P45	P45	Kompatibel	Kompatibel	Kompatibel	Kompatibel	Kompatibel	Kompatibel
5.5	Kompatibel	Kompatibel	Kompatibel	Kompatibel	Kompatibel	Kompatibel	Kompatibel	Kompatibel

\* Hinterdrehen bei Linksgewindedrehen.

Beim Austausch der Unterlegplatte vergewissern Sie sich, dass die Differenz aus Anstellwinkel und Plattenneigungswinkel zwischen:

2.5°–0.5° bei Steigungswinkel 60° (55°)

2°–1° bei Steigungswinkel 30° (29°)

\* Neigungswinkel der Standard Unterlegplatte ist 0°.

\* Der Halter hat einen Anstellwinkel von 1.5°.

## BERECHNUNG DES GEWINDEANSTELLWINKELS

$$\tan \alpha = \frac{l}{\pi d} = \frac{nP}{\pi d}$$

$\alpha$  : Anstellwinkel  
 $l$  : Gewindelänge  
 $n$  : Durchgänge  
 $P$  : Steigung  
 $d$  : Mittlerer Gewindedurchmesser

## BEISPIEL ZUR AUSWAHL DER UNTERLEGPLATTE

• Bei einem Anstellwinkel von 2.2°

① Bei einem Steigungswinkel von 60°

(2.2° Anstellwinkel) – (2.5° – 0.5°) = -0.3° – 1.7° Neigungswinkel der Unterlegplatte sind möglich.

Die Standard Unterlegplatte (0° Neigungswinkel) ist einsetzbar. Eine Unterlegplatte mit 1° Neigungswinkel ist zu empfehlen. Auswahl siehe Seite G019 und G026.

② Bei einem Steigungswinkel von 30°

(2.2° Anstellwinkel) – (2° – 1°) = -0.2° – 1.2° Neigungswinkel der Unterlegplatte sind möglich.

Ersetzen Sie die Standard Unterlegplatte durch eine Unterlegplatte mit einem Neigungswinkel von 1°. Auswahl siehe Seite G019 und G026.

## FREIWINKEL DER WSP

Steigungswinkel	Freiwinkel Innengewinde	Freiwinkel Aussengewinde
60°	8.8°	5.8°
55°	7.9°	5.2°
30°	4.1°	2.7°
29°	4°	2.6°

• Die Freiwinkel ( $\beta_2, \beta_1$ ) der WSP werden bei anderen Steigungswinkeln, z.B. bei Trapez, Rund oder Feingewinden, kleiner. Bitte beachten Sie dies bei der Auswahl der Unterlegplatten.



# GEWINDE DREHEN

## STANDARD SCHNITTtieFE AUSSEN (RADIALE ZUSTELLUNG)

### Metrisch ISO

Steigung (mm)	Schnitttiefe	Anzahl der Durchgänge														WSP Ausführung		
		1	2	3	4	5	6	7	8	9	10	11	12	13	14	G-Toleranz WSP	M-Toleranz WSP mit 3D-Geometrie	
0.5	0.31	0.10	0.08	0.07	0.06												MMT16ER050ISO	—
0.75	0.46	0.16	0.14	0.10	0.06												MMT16ER075ISO	—
1.0	0.61	0.18	0.15	0.12	0.10	0.06											MMT16ER100ISO	MMT16ER100ISO-S
1.25	0.77	0.19	0.17	0.14	0.11	0.10	0.06										MMT16ER125ISO	MMT16ER125ISO-S
1.5	0.92	0.22	0.21	0.17	0.14	0.12	0.06										MMT16ER150ISO	MMT16ER150ISO-S
1.75	1.07	0.22	0.21	0.16	0.13	0.11	0.09	0.09	0.06								MMT16ER175ISO	MMT16ER175ISO-S
2.0	1.23	0.24	0.23	0.17	0.16	0.14	0.12	0.11	0.06								MMT16ER200ISO	MMT16ER200ISO-S
2.5	1.53	0.26	0.23	0.19	0.17	0.15	0.13	0.12	0.11	0.11	0.06						MMT16ER250ISO	MMT16ER250ISO-S
3.0	1.84	0.27	0.25	0.20	0.18	0.16	0.14	0.13	0.12	0.12	0.11	0.10	0.06				MMT16ER300ISO	MMT16ER300ISO-S
3.5	2.15	0.33	0.30	0.24	0.21	0.18	0.17	0.15	0.14	0.14	0.12	0.11	0.06				MMT22ER350ISO	—
4.0	2.45	0.34	0.31	0.24	0.22	0.19	0.17	0.16	0.14	0.14	0.13	0.12	0.12	0.11	0.06		MMT22ER400ISO	—
4.5	2.76	0.38	0.34	0.28	0.24	0.22	0.20	0.18	0.16	0.16	0.15	0.14	0.13	0.12	0.06		MMT22ER450ISO	—
5.0	3.07	0.42	0.38	0.32	0.27	0.24	0.22	0.20	0.18	0.18	0.17	0.16	0.15	0.12	0.06		MMT22ER500ISO	—

### Gewindeform UN-amerikanisch

Steigung (Gang/Zoll)	Schnitttiefe	Anzahl der Durchgänge														WSP Ausführung		
		1	2	3	4	5	6	7	8	9	10	11	12	13	14	G-Toleranz WSP	M-Toleranz WSP mit 3D-Geometrie	
32	0.49	0.17	0.15	0.11	0.06												MMT16ER320UN	—
28	0.56	0.17	0.14	0.10	0.09	0.06											MMT16ER280UN	—
24	0.65	0.18	0.16	0.14	0.11	0.06											MMT16ER240UN	—
20	0.78	0.20	0.18	0.13	0.11	0.10	0.06										MMT16ER200UN	—
18	0.87	0.22	0.20	0.15	0.13	0.11	0.06										MMT16ER180UN	—
16	0.97	0.22	0.20	0.15	0.12	0.11	0.11	0.06									MMT16ER160UN	MMT16ER160UN-S
14	1.11	0.23	0.21	0.16	0.13	0.11	0.11	0.10	0.06								MMT16ER140UN	MMT16ER140UN-S
13	1.20	0.25	0.22	0.17	0.14	0.13	0.12	0.11	0.06								MMT16ER130UN	—
12	1.30	0.28	0.23	0.18	0.16	0.14	0.13	0.12	0.06								MMT16ER120UN	MMT16ER120UN-S
11	1.42	0.28	0.23	0.19	0.16	0.14	0.13	0.12	0.11	0.06							MMT16ER110UN	—
10	1.56	0.28	0.24	0.19	0.16	0.14	0.13	0.13	0.12	0.11	0.06						MMT16ER100UN	—
9	1.73	0.34	0.29	0.22	0.17	0.15	0.14	0.13	0.12	0.11	0.06						MMT16ER090UN	—
8	1.95	0.35	0.30	0.24	0.19	0.16	0.15	0.14	0.13	0.12	0.11	0.06					MMT16ER080UN	—
7	2.22	0.37	0.33	0.28	0.24	0.20	0.17	0.16	0.15	0.14	0.12	0.06					MMT22ER070UN	—
6	2.60	0.42	0.35	0.29	0.25	0.21	0.18	0.17	0.16	0.15	0.13	0.12	0.11	0.06			MMT22ER060UN	—
5	3.12	0.43	0.39	0.31	0.27	0.24	0.22	0.20	0.19	0.19	0.18	0.17	0.15	0.12	0.06		MMT22ER050UN	—

### Whitworth für BSW, BSP

Steigung (Gang/Zoll)	Schnitttiefe	Anzahl der Durchgänge														WSP Ausführung		
		1	2	3	4	5	6	7	8	9	10	11	12	13	14	G-Toleranz WSP	M-Toleranz WSP mit 3D-Geometrie	
28	0.58	0.17	0.14	0.11	0.10	0.06											MMT16ER280W	—
26	0.63	0.18	0.15	0.13	0.11	0.06											MMT16ER260W	—
20	0.81	0.20	0.18	0.14	0.12	0.11	0.06										MMT16ER200W	—
19	0.86	0.21	0.19	0.15	0.13	0.12	0.06										MMT16ER190W	MMT16ER190W-S
18	0.90	0.25	0.19	0.15	0.13	0.12	0.06										MMT16ER180W	—
16	1.02	0.21	0.18	0.15	0.13	0.11	0.09	0.09	0.06								MMT16ER160W	—
14	1.16	0.23	0.21	0.17	0.14	0.12	0.12	0.11	0.06								MMT16ER140W	MMT16ER140W-S
12	1.36	0.27	0.25	0.20	0.16	0.15	0.14	0.13	0.06								MMT16ER120W	—
11	1.48	0.27	0.24	0.20	0.17	0.15	0.14	0.13	0.12	0.06							MMT16ER110W	MMT16ER110W-S
10	1.63	0.27	0.25	0.20	0.17	0.15	0.15	0.13	0.13	0.12	0.06						MMT16ER100W	—
9	1.81	0.28	0.26	0.21	0.18	0.16	0.15	0.14	0.13	0.12	0.12	0.06					MMT16ER090W	—
8	2.03	0.30	0.27	0.22	0.19	0.17	0.16	0.15	0.14	0.13	0.12	0.12	0.06				MMT16ER080W	—
7	2.32	0.34	0.32	0.26	0.22	0.20	0.18	0.17	0.16	0.15	0.14	0.12	0.06				MMT22ER070W	—
6	2.71	0.35	0.33	0.27	0.23	0.21	0.20	0.19	0.17	0.16	0.15	0.14	0.13	0.12	0.06		MMT22ER060W	—
5	3.25	0.42	0.40	0.35	0.29	0.26	0.24	0.22	0.20	0.19	0.18	0.17	0.15	0.12	0.06		MMT22ER050W	—

### BSPT

Steigung (Gang/Zoll)	Schnitttiefe	Anzahl der Durchgänge														WSP Ausführung		
		1	2	3	4	5	6	7	8	9						G-Toleranz WSP	M-Toleranz WSP mit 3D-Geometrie	
28	0.58	0.17	0.14	0.11	0.10	0.06											MMT16ER280BSPT	—
19	0.86	0.22	0.19	0.15	0.12	0.12	0.06										MMT16ER190BSPT	MMT16ER190BSPT-S
14	1.16	0.24	0.20	0.17	0.14	0.12	0.12	0.11	0.06								MMT16ER140BSPT	MMT16ER140BSPT-S
11	1.48	0.25	0.23	0.21	0.18	0.16	0.14	0.13	0.12	0.06							MMT16ER110BSPT	MMT16ER110BSPT-S

Hinweis 1) Bitte achten Sie auf die Schnitttiefe und die Anzahl der Durchgänge, um Ausbrüche am Radius der Schneidkante zu verhindern.

Bei austenitischem rostfreien Stahl sollte eine Zustellung unter 0.1mm vermieden werden.

Hinweis 2) Bei einer Teilprofil- oder Innengewinde-WSP mit kleinem Eckenradius bitte Schnitttiefe und Anzahl der Durchgänge beachten, um Schäden an der WSP-Ecke zu vermeiden.

## ■ Rund-DIN 405

Steigung (Gang/ Zoll)	Schnitttiefe	Anzahl der Durchgänge														WSP Ausführung		
		1	2	3	4	5	6	7	8	9	10	11	12	13	14			
10	1.27	0.23	0.21	0.20	0.19	0.16	0.12	0.10	0.06									MMT16ER100RD
8	1.59	0.23	0.21	0.20	0.19	0.18	0.16	0.14	0.12	0.10	0.06							MMT16ER080RD
6	2.12	0.26	0.25	0.24	0.22	0.21	0.19	0.17	0.16	0.14	0.12	0.10	0.06					MMT16ER060RD
4	3.18	0.34	0.33	0.32	0.30	0.28	0.26	0.24	0.22	0.20	0.19	0.17	0.15	0.12	0.06			MMT22ER040RD

## ■ ISO Trapez 30°

Steigung (mm)	Schnitttiefe	Anzahl der Durchgänge														WSP Ausführung		
		1	2	3	4	5	6	7	8	9	10	11	12	13	14			
1.5	0.90	0.23	0.21	0.16	0.13	0.11	0.06											MMT16ER150TR
2.0	1.25	0.29	0.26	0.21	0.17	0.14	0.12	0.06										MMT16ER200TR
3.0	1.75	0.32	0.31	0.24	0.19	0.18	0.17	0.15	0.13	0.06								MMT16ER300TR
4.0	2.25	0.33	0.32	0.24	0.22	0.21	0.17	0.16	0.15	0.14	0.13	0.12	0.16					MMT22ER400TR
5.0	2.75	0.35	0.32	0.26	0.24	0.22	0.21	0.19	0.19	0.17	0.15	0.14	0.13	0.12	0.06			MMT22ER500TR

## ■ Gewindeform ACME-amerikanisch

Steigung (Gang/ Zoll)	Schnitttiefe	Anzahl der Durchgänge														WSP Ausführung		
		1	2	3	4	5	6	7	8	9	10	11	12	13	14			
12	1.19	0.27	0.23	0.20	0.17	0.14	0.12	0.06										MMT16ER120ACME
10	1.52	0.29	0.25	0.21	0.18	0.16	0.14	0.12	0.11	0.06								MMT16ER100ACME
8	1.84	0.30	0.26	0.22	0.19	0.16	0.15	0.14	0.13	0.12	0.11	0.06						MMT16ER080ACME
6	2.37	0.34	0.30	0.27	0.24	0.21	0.19	0.16	0.14	0.12	0.12	0.11	0.11	0.06				MMT22ER060ACME
5	2.79	0.36	0.33	0.30	0.26	0.23	0.20	0.18	0.17	0.16	0.15	0.14	0.13	0.12	0.06			MMT22ER050ACME

## ■ UNJ

Steigung (Gang/ Zoll)	Schnitttiefe	Anzahl der Durchgänge														WSP Ausführung		
		1	2	3	4	5	6	7	8	9	10	11						
32	0.46	0.16	0.14	0.10	0.06													MMT16ER320UNJ
28	0.52	0.16	0.12	0.09	0.09	0.06												MMT16ER280UNJ
24	0.61	0.17	0.14	0.14	0.10	0.06												MMT16ER240UNJ
20	0.73	0.19	0.16	0.13	0.10	0.09	0.06											MMT16ER200UNJ
18	0.81	0.23	0.18	0.14	0.10	0.10	0.06											MMT16ER180UNJ
16	0.92	0.26	0.21	0.14	0.12	0.10	0.09											MMT16ER160UNJ
14	1.05	0.26	0.23	0.17	0.12	0.11	0.10	0.06										MMT16ER140UNJ
12	1.22	0.28	0.27	0.20	0.17	0.13	0.11	0.06										MMT16ER120UNJ
10	1.47	0.30	0.29	0.21	0.15	0.13	0.12	0.11	0.10	0.06								MMT16ER100UNJ
8	1.83	0.31	0.30	0.23	0.18	0.15	0.14	0.13	0.12	0.11	0.10	0.06						MMT16ER080UNJ

## ■ API Rohrgewinde

Steigung (Gang/ Zoll)	Schnitttiefe	Anzahl der Durchgänge														WSP Ausführung		
		1	2	3	4	5	6	7	8	9	10	11						
5	1.55	0.25	0.23	0.17	0.15	0.13	0.12	0.12	0.11	0.11	0.10	0.06						MMT22ER050APBU

## ■ API Gehäuse und Welle

Steigung (Gang/ Zoll)	Schnitttiefe	Anzahl der Durchgänge														WSP Ausführung		
		1	2	3	4	5	6	7	8	9	10	11	12					
10	1.41	0.25	0.23	0.16	0.14	0.12	0.12	0.12	0.11	0.10	0.06							MMT16ER100APRD
8	1.81	0.25	0.24	0.19	0.16	0.14	0.14	0.13	0.13	0.13	0.13	0.13	0.11	0.06				MMT16ER080APRD

## ■ Gewindeform NPT-amerikanisch

Steigung (Gang/ Zoll)	Schnitttiefe	Anzahl der Durchgänge															WSP Ausführung	
		1	2	3	4	5	6	7	8	9	10	11	12	13	14	15		
27	0.66	0.15	0.13	0.12	0.11	0.09	0.06											MMT16ER270NPT
18	1.01	0.20	0.16	0.14	0.13	0.12	0.11	0.09	0.06									MMT16ER180NPT
14	1.33	0.23	0.19	0.16	0.14	0.13	0.12	0.11	0.10	0.09	0.06							MMT16ER140NPT
11.5	1.64	0.24	0.19	0.17	0.15	0.15	0.13	0.13	0.12	0.11	0.10	0.09	0.06					MMT16ER115NPT
8	2.42	0.33	0.28	0.23	0.20	0.18	0.16	0.15	0.14	0.13	0.12	0.12	0.11	0.11	0.10	0.06		MMT16ER080NPT

## ■ Gewindeform NPTF-amerikanisch

Steigung (Gang/ Zoll)	Schnitttiefe	Anzahl der Durchgänge															WSP Ausführung	
		1	2	3	4	5	6	7	8	9	10	11	12	13	14	15		
27	0.64	0.16	0.14	0.11	0.09	0.08	0.06											MMT16ER270NPTF
18	1.00	0.19	0.16	0.14	0.13	0.12	0.11	0.09	0.06									MMT16ER180NPTF
14	1.35	0.23	0.21	0.16	0.14	0.13	0.12	0.11	0.10	0.09	0.06							MMT16ER140NPTF
11.5	1.63	0.24	0.23	0.19	0.15	0.13	0.11	0.11	0.11	0.10	0.10	0.10	0.06					MMT16ER115NPTF
8	2.38	0.32	0.27	0.23	0.19	0.17	0.16	0.15	0.14	0.13	0.12	0.12	0.11	0.11	0.10	0.06		MMT16ER080NPTF

Hinweis 1) Bitte achten Sie auf die Schnitttiefe und die Anzahl der Durchgänge, um Ausbrüche am Radius der Schneidkante zu verhindern.

Bei austenitischem rostfreien Stahl sollte eine Zustellung unter 0.1mm vermieden werden.

Hinweis 2) Bei einer Teilprofil- oder Innengewinde-WSP mit kleinem Eckenradius bitte Schnitttiefe und Anzahl der Durchgänge beachten, um Schäden an der WSP-Ecke zu vermeiden.



# GEWINDE DREHEN

## STANDARD SCHNITTIEFE INNEN (RADIALE ZUSTELLUNG)

### Metrisch ISO

Steigung (mm)	Schnitttiefe	Anzahl der Durchgänge														WSP Ausführung					
		1	2	3	4	5	6	7	8	9	10	11	12	13	14	G-Toleranz WSP		M-Toleranz WSP mit 3D-Geometrie			
0.5	0.29	0.09	0.07	0.07	0.06													MMT11R050ISO	MMT16R050ISO	—	—
0.75	0.43	0.15	0.13	0.09	0.06													MMT11R075ISO	MMT16R075ISO	—	—
1.0	0.58	0.17	0.15	0.11	0.09	0.06												MMT11R100ISO	MMT16R100ISO	MMT11R100ISO-S	MMT16R100ISO-S
1.25	0.72	0.18	0.16	0.12	0.11	0.09	0.06											MMT11R125ISO	MMT16R125ISO	MMT11R125ISO-S	MMT16R125ISO-S
1.5	0.87	0.21	0.20	0.16	0.13	0.11	0.06											MMT11R150ISO	MMT16R150ISO	MMT11R150ISO-S	MMT16R150ISO-S
1.75	1.01	0.21	0.20	0.15	0.12	0.10	0.09	0.08	0.06									MMT11R175ISO	MMT16R175ISO	—	MMT16R175ISO-S
2.0	1.15	0.24	0.22	0.18	0.14	0.12	0.10	0.09	0.06									MMT11R200ISO	MMT16R200ISO	—	MMT16R200ISO-S
2.5	1.44	0.25	0.24	0.21	0.15	0.13	0.12	0.10	0.09	0.09	0.06							—	MMT16R250ISO	—	MMT16R250ISO-S
3.0	1.73	0.26	0.25	0.22	0.17	0.14	0.13	0.12	0.11	0.10	0.09	0.08	0.06					—	MMT16R300ISO	—	MMT16R300ISO-S
3.5	2.02	0.32	0.30	0.23	0.19	0.17	0.15	0.14	0.13	0.12	0.11	0.10	0.06					—	MMT22R350ISO	—	—
4.0	2.31	0.33	0.31	0.24	0.22	0.18	0.15	0.14	0.13	0.12	0.12	0.11	0.10	0.10	0.06			—	MMT22R400ISO	—	—
4.5	2.60	0.36	0.33	0.28	0.24	0.21	0.19	0.16	0.15	0.14	0.13	0.12	0.12	0.11	0.06			—	MMT22R450ISO	—	—
5.0	2.89	0.41	0.38	0.32	0.27	0.24	0.21	0.18	0.16	0.15	0.14	0.13	0.12	0.12	0.06			—	MMT22R500ISO	—	—

### Gewindeform UN-amerikanisch

Steigung (Gang/Zoll)	Schnitttiefe	Anzahl der Durchgänge														WSP Ausführung					
		1	2	3	4	5	6	7	8	9	10	11	12	13	14	G-Toleranz WSP		M-Toleranz WSP mit 3D-Geometrie			
32	0.46	0.16	0.14	0.10	0.06													MMT11R320UN	MMT16R320UN	—	—
28	0.52	0.16	0.13	0.09	0.08	0.06												MMT11R280UN	MMT16R280UN	—	—
24	0.61	0.17	0.15	0.13	0.10	0.06												MMT11R240UN	MMT16R240UN	—	—
20	0.73	0.18	0.15	0.13	0.11	0.10	0.06											MMT11R200UN	MMT16R200UN	—	—
18	0.81	0.20	0.18	0.14	0.12	0.11	0.06											MMT11R180UN	MMT16R180UN	—	—
16	0.92	0.20	0.18	0.15	0.12	0.11	0.10	0.06										MMT11R160UN	MMT16R160UN	MMT16R160UN-S	—
14	1.05	0.21	0.18	0.15	0.13	0.11	0.11	0.10	0.06									MMT11R140UN	MMT16R140UN	MMT16R140UN-S	—
13	1.13	0.22	0.19	0.16	0.14	0.13	0.12	0.11	0.06									—	MMT16R130UN	—	—
12	1.22	0.24	0.22	0.18	0.16	0.13	0.12	0.11	0.06									—	MMT16R120UN	MMT16R120UN-S	—
11	1.33	0.24	0.22	0.20	0.15	0.12	0.12	0.11	0.11	0.06								—	MMT16R110UN	—	—
10	1.47	0.25	0.22	0.21	0.14	0.13	0.12	0.12	0.11	0.11	0.06							—	MMT16R100UN	—	—
9	1.63	0.31	0.23	0.21	0.17	0.15	0.14	0.13	0.12	0.11	0.06							—	MMT16R090UN	—	—
8	1.83	0.31	0.26	0.21	0.18	0.16	0.15	0.14	0.13	0.12	0.11	0.06						—	MMT16R080UN	—	—
7	2.09	0.36	0.30	0.24	0.21	0.18	0.17	0.16	0.15	0.14	0.12	0.06						—	MMT22R070UN	—	—
6	2.44	0.40	0.33	0.25	0.23	0.19	0.17	0.16	0.15	0.14	0.13	0.12	0.11	0.06				—	MMT22R060UN	—	—
5	2.93	0.41	0.35	0.31	0.26	0.23	0.21	0.20	0.19	0.17	0.15	0.14	0.13	0.12	0.06			—	MMT22R050UN	—	—

### Whitworth für BSW, BSP

Steigung (Gang/Zoll)	Schnitttiefe	Anzahl der Durchgänge														WSP Ausführung					
		1	2	3	4	5	6	7	8	9	10	11	12	13	14	G-Toleranz WSP		M-Toleranz WSP mit 3D-Geometrie			
28	0.58	0.17	0.14	0.11	0.10	0.06												—	MMT16R280W	—	—
26	0.63	0.18	0.15	0.13	0.11	0.06												—	MMT16R260W	—	—
20	0.81	0.20	0.18	0.14	0.12	0.11	0.06											—	MMT16R200W	—	—
19	0.86	0.21	0.19	0.15	0.13	0.12	0.06											MMT11R190W	MMT16R190W	MMT16R190W-S	—
18	0.90	0.25	0.19	0.15	0.13	0.12	0.06											—	MMT16R180W	—	—
16	1.02	0.21	0.18	0.15	0.13	0.11	0.09	0.09	0.06									—	MMT16R160W	—	—
14	1.16	0.23	0.21	0.17	0.14	0.12	0.12	0.11	0.06									MMT11R140W	MMT16R140W	MMT16R140W-S	—
12	1.36	0.27	0.25	0.20	0.16	0.15	0.14	0.13	0.06									—	MMT16R120W	MMT16R120W-S	—
11	1.48	0.27	0.24	0.20	0.17	0.15	0.14	0.13	0.12	0.06								—	MMT16R110W	—	—
10	1.63	0.27	0.25	0.20	0.17	0.15	0.15	0.13	0.13	0.12	0.06							—	MMT16R100W	—	—
9	1.81	0.28	0.26	0.21	0.18	0.16	0.15	0.14	0.13	0.12	0.12	0.06						—	MMT16R090W	—	—
8	2.03	0.30	0.27	0.22	0.19	0.17	0.16	0.15	0.14	0.13	0.12	0.12	0.06					—	MMT16R080W	—	—
7	2.32	0.34	0.32	0.26	0.22	0.20	0.18	0.17	0.16	0.15	0.14	0.12	0.06					—	MMT22R070W	—	—
6	2.71	0.35	0.33	0.27	0.23	0.21	0.20	0.19	0.17	0.16	0.15	0.14	0.13	0.12	0.06			—	MMT22R060W	—	—
5	3.25	0.42	0.40	0.35	0.29	0.26	0.24	0.22	0.20	0.19	0.18	0.17	0.15	0.12	0.06			—	MMT22R050W	—	—

Hinweis 1) Bitte achten Sie auf die Schnitttiefe und die Anzahl der Durchgänge, um Ausbrüche am Radius der Schneidkante zu verhindern. Bei austenitischem rostfreien Stahl sollte eine Zustellung unter 0.1mm vermieden werden.

Hinweis 2) Bei einer Teilprofil- oder Innengewinde-WSP mit kleinem Eckenradius bitte Schnitttiefe und Anzahl der Durchgänge beachten, um Schäden an der WSP-Ecke zu vermeiden.

## ■ BSPT

Steigung (Gang/ Zoll)	Schnitttiefe	Anzahl der Durchgänge													WSP Ausführung				
		1	2	3	4	5	6	7	8	9							G-Toleranz WSP	M-Toleranz WSP mit 3D-Geometrie	
19	0.86	0.22	0.19	0.15	0.12	0.12	0.06										MMT11R190BSPT	MMT16R190BSPT	MMT16R190BSPT-S
14	1.16	0.24	0.20	0.17	0.14	0.12	0.12	0.11	0.06								MMT11R140BSPT	MMT16R140BSPT	MMT16R140BSPT-S
11	1.48	0.25	0.23	0.21	0.18	0.16	0.14	0.13	0.12	0.06							—	MMT16R110BSPT	MMT16R110BSPT-S

## ■ Rund-DIN 405

Steigung (Gang/ Zoll)	Schnitttiefe	Anzahl der Durchgänge														WSP Ausführung			
		1	2	3	4	5	6	7	8	9	10	11	12	13	14				
10	1.27	0.23	0.21	0.20	0.19	0.16	0.12	0.10	0.06										MMT16R100RD
8	1.59	0.23	0.21	0.20	0.19	0.18	0.16	0.14	0.12	0.10	0.06								MMT16R080RD
6	2.12	0.26	0.25	0.24	0.22	0.21	0.19	0.17	0.16	0.14	0.12	0.10	0.06						MMT16R060RD
4	3.18	0.34	0.33	0.32	0.30	0.28	0.26	0.24	0.22	0.20	0.19	0.17	0.15	0.12	0.06				MMT22R040RD

## ■ ISO Trapez 30°

Steigung (mm)	Schnitttiefe	Anzahl der Durchgänge														WSP Ausführung			
		1	2	3	4	5	6	7	8	9	10	11	12	13	14				
1.5	0.90	0.23	0.21	0.16	0.13	0.11	0.06												MMT16R150TR
2	1.25	0.29	0.26	0.21	0.17	0.14	0.12	0.06											MMT16R200TR
3	1.75	0.32	0.31	0.24	0.19	0.18	0.17	0.15	0.13	0.06									MMT16R300TR
4	2.25	0.33	0.32	0.24	0.22	0.21	0.17	0.16	0.15	0.14	0.13	0.12	0.06						MMT22R400TR
5	2.75	0.35	0.32	0.26	0.24	0.22	0.21	0.19	0.19	0.17	0.15	0.14	0.13	0.12	0.06				MMT22R500TR

## ■ Gewindeform ACME-amerikanisch

Steigung (Gang/ Zoll)	Schnitttiefe	Anzahl der Durchgänge														WSP Ausführung			
		1	2	3	4	5	6	7	8	9	10	11	12	13	14				
12	1.19	0.27	0.23	0.20	0.17	0.14	0.12	0.06											MMT16R120ACME
10	1.52	0.29	0.25	0.21	0.18	0.16	0.14	0.12	0.11	0.06									MMT16R100ACME
8	1.84	0.30	0.26	0.22	0.19	0.16	0.15	0.14	0.13	0.12	0.11	0.06							MMT16R080ACME
6	2.37	0.34	0.30	0.27	0.24	0.21	0.19	0.16	0.14	0.12	0.12	0.11	0.11	0.06					MMT22R060ACME
5	2.79	0.36	0.33	0.30	0.26	0.23	0.20	0.18	0.17	0.16	0.15	0.14	0.13	0.12	0.06				MMT22R050ACME

## ■ API Rohrgewinde

Steigung (Gang/ Zoll)	Schnitttiefe	Anzahl der Durchgänge														WSP Ausführung			
		1	2	3	4	5	6	7	8	9	10	11							
5	1.55	0.25	0.23	0.17	0.15	0.13	0.12	0.12	0.11	0.11	0.10	0.06							MMT22R050APBU

## ■ API Gehäuse und Welle

Steigung (Gang/ Zoll)	Schnitttiefe	Anzahl der Durchgänge												WSP Ausführung					
		1	2	3	4	5	6	7	8	9	10	11	12						
10	1.41	0.25	0.23	0.16	0.14	0.12	0.12	0.12	0.11	0.10	0.06								MMT16R100APRD
8	1.81	0.25	0.24	0.19	0.16	0.14	0.14	0.13	0.13	0.13	0.13	0.11	0.06						MMT16R080APRD

## ■ Gewindeform NPT-amerikanisch

Steigung (Gang/ Zoll)	Schnitttiefe	Anzahl der Durchgänge															WSP Ausführung		
		1	2	3	4	5	6	7	8	9	10	11	12	13	14	15			
27	0.66	0.15	0.13	0.12	0.11	0.09	0.06												MMT16R270NPT
18	1.01	0.20	0.16	0.14	0.13	0.12	0.11	0.09	0.06										MMT16R180NPT
14	1.33	0.23	0.19	0.16	0.14	0.13	0.12	0.11	0.10	0.09	0.06								MMT16R140NPT
11.5	1.64	0.24	0.19	0.17	0.15	0.15	0.13	0.13	0.12	0.11	0.10	0.09	0.06						MMT16R115NPT
8	2.42	0.33	0.28	0.23	0.20	0.18	0.16	0.15	0.14	0.13	0.12	0.12	0.11	0.11	0.10	0.06			MMT16R080NPT

## ■ Gewindeform NPTF-amerikanisch

Steigung (Gang/ Zoll)	Schnitttiefe	Anzahl der Durchgänge															WSP Ausführung		
		1	2	3	4	5	6	7	8	9	10	11	12	13	14	15			
14	1.35	0.23	0.21	0.16	0.14	0.13	0.12	0.11	0.10	0.09	0.06								MMT16R140NPTF
11.5	1.63	0.24	0.23	0.19	0.15	0.13	0.11	0.11	0.11	0.10	0.10	0.10	0.06						MMT16R115NPTF
8	2.38	0.32	0.27	0.23	0.19	0.17	0.16	0.15	0.14	0.13	0.12	0.12	0.11	0.11	0.10	0.06			MMT16R080NPTF

Hinweis 1) Bitte achten Sie auf die Schnitttiefe und die Anzahl der Durchgänge, um Ausbrüche am Radius der Schneidkante zu verhindern. Bei austenitischem rostfreien Stahl sollte eine Zustellung unter 0.1mm vermieden werden.

Hinweis 2) Bei einer Teilprofil- oder Innengewinde-WSP mit kleinem Eckenradius bitte Schnitttiefe und Anzahl der Durchgänge beachten, um Schäden an der WSP-Ecke zu vermeiden.

G

GEWINDE DREHEN

# BESTELLBEZEICHNUNG FÜR DIE MMT-SERIE

## HALTER

**AUSSEN**

**MMT E R 12 12 H 16 - C**

**Bestimmung**

**Anwendung**  
E Aussen

**Bearbeitungsrichtung**  
R Rechts

**Schaftquerschnitt (mm) (Höhe und Breite)**

12	12
16	16
20	20
25	25
32	32

**Werkzeuiglänge (mm)**

H	100
K	125
M	150
P	170

**WSP-Größe (mm)**

16	9.525
22	12.7

**Spannsystem**  
C Spannfingerklemmung

---

**INNEN**

**MMT I R 13 16 A K 11 - S P15**

**Bestimmung**

**Anwendung**  
I Innen

**Bearbeitungsrichtung**  
R Rechts

**Min. Durchmesser (mm)**  
13

**Schaftdurchmesser (mm)**  
16

**Schaftausführung**  
A Stahlschaft mit Kühlmittelbohrung

**Werkzeuiglänge (mm)**

K	125	R	200
M	150	S	250
Q	180	T	300

**WSP-Größe (mm)**

11	6.35
16	9.525
22	12.7

**Spannsystem**  
S Schraubklemmung  
C Spannfingerklemmung

**Anstellwinkel**

P15	1.5°
P25	2.5°
P35	3.5°

G

GEWINDE DREHEN

## WSP

**M-KLASSE**

**MMT 16 E R 100 ISO - S**

**Bestimmung**

**Innenkreis Durchmesser (mm)**

11	6.35
16	9.525

**Anwendung**  
E Aussen  
I Innen

**Bearbeitungsrichtung**  
R Rechts

**Steigung**

100	1.0mm	A	0.5–1.5mm oder 48–16 Gang/Zoll
125	1.25mm		
150	1.5mm	G	1.75–3.0mm oder 14–8 Gang/Zoll
175	1.75mm		
200	2.0mm	AG	0.5–3.0mm oder 48–8 Gang/Zoll
250	2.5mm		
300	3.0mm		

**Gewinde Typ**

S	M-Toleranz WSP mit 3D-Geometrie
60	Teilprofil 60°
55	Teilprofil 55°
ISO	Metrisch ISO
W	Whitworth für BSW, BSP
BSPT	BSPT
UN	Gewindeform UN-amerikanisch

---

**G-KLASSE**

**MMT 16 E R 050 ISO**

**Bestimmung**

**Innenkreis Durchmesser (mm)**

11	6.35
16	9.525
22	12.7

**Anwendung**  
E Aussen  
I Innen

**Bearbeitungsrichtung**  
R Rechts

**Steigung**

050	0.5mm	A	0.5–1.5mm oder 48–16 Gang/Zoll
075	0.75mm		
100	1.0mm	G	1.75–3.0mm oder 14–8 Gang/Zoll
125	1.25mm		
150	1.5mm	AG	0.5–3.0mm oder 48–8 Gang/Zoll
175	1.75mm		
200	2.0mm		
250	2.5mm	N	3.5–5.0mm oder 7–5 Gang/Zoll
300	3.0mm		
350	3.5mm		
400	4.0mm		
450	4.5mm	N	7–5 Gang/Zoll
500	5.0mm		

**Gewinde Typ**

60	Teilprofil 60°
55	Teilprofil 55°
ISO	Metrisch ISO
W	Whitworth für BSW, BSP
BSPT	BSPT
UN	Gewindeform UN-amerikanisch
RD	Rund-DIN 405
TR	ISO Trapez 30°
ACME	Gewindeform ACME-amerikanisch
UNJ	UNJ
APBU	API Rohrgewinde
APRD	API Gehäuse und Welle
NPT	NPT
NPTF	NPTF

# AUSSENGEWINDE DREHEN

## MMTE HALTER

- Verschiedenste WSP-Formen und -Sorten.
- Präzisions-WSP.
- Verfügbar mit einer Wiper Schneidkantenausführung, um eine exakte Gewindeschneidgeometrie zu erhalten.
- Veränderung des Anstellwinkels durch Auswechslung der Unterlegplatte.

# MMTE

### Aussengewinde drehen

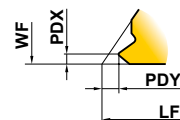
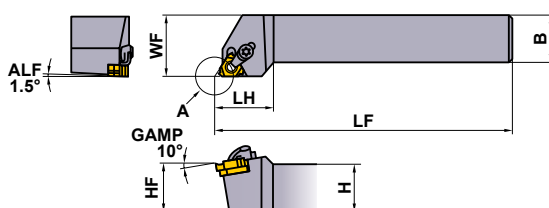
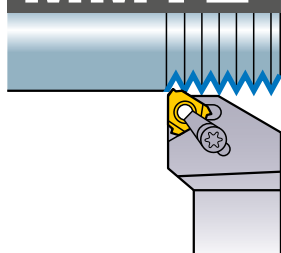

Detail A  
(Beachten Sie die Seiten  
G020—G023 für die Maße  
PDX und PDY)

Nur Rechtsausführung lieferbar.

Bestellbezeichnung	Lager R	WSP Bezeichnung	Abmessungen (mm)						Zugehörige Werkzeuge					
			H	B	LF	LH	HF	WF	Spannfinger	Spannschraube	Sprengring	Unterlegschraube	Unterlegplatte	Schlüssel
MMTER1212H16-C	●	MMT16ER	12	12	100	25	12	16	SETK51	SETS51	CR4	HFC03008	CTE32TP15	⓪TKY15F ⓪HKY20R
MMTER1616H16-C	●		16	16	100	25	16	20	SETK51	SETS51	CR4	HFC03008	CTE32TP15	⓪TKY15F ⓪HKY20R
MMTER2020K16-C	●		20	20	125	26	20	25	SETK51	SETS51	CR4	HFC03008	CTE32TP15	⓪TKY15F ⓪HKY20R
MMTER2525M16-C	●		25	25	150	28	25	32	SETK51	SETS51	CR4	HFC03008	CTE32TP15	⓪TKY15F ⓪HKY20R
MMTER3232P16-C	●		32	32	170	32	32	40	SETK51	SETS51	CR4	HFC03008	CTE32TP15	⓪TKY15F ⓪HKY20R
MMTER2525M22-C	●	MMT22ER	25	25	150	32	25	32	SETK61	SETS61	CR5	HFC04010	CTE43TP15	⓪TKY20F ⓪HKY25R
MMTER3232P22-C	●		32	32	170	32	32	40	SETK61	SETS61	CR5	HFC04010	CTE43TP15	⓪TKY20F ⓪HKY25R

Hinweis 1) Einsetzen weiterer Unterlegplatten (separate Bestellung) in Abhängigkeit des Anstellwinkels.

\* Spannmoment (N • m) : SETS51=3.5, SETS61=5.0, HFC03008=1.5, HFC04010=2.2

## UNTERLEGPLATTE

Anstellwinkel (α°)	Bestellbezeichnung	Lager R	Neigungswinkel (θ°)	Zugehöriger Halter	Anstellwinkel (α°)	Bestellbezeichnung	Lager R	Neigungswinkel (θ°)	Zugehöriger Halter
-1.5°	CTE32TN15	●	-3°	MMTER 16-C	-1.5°	CTE43TN15	●	-3°	MMTER 22-C
-0.5°	CTE32TN05	●	-2°		-0.5°	CTE43TN05	●	-2°	
0.5°	CTE32TP05	●	-1°		0.5°	CTE43TP05	●	-1°	
1.5°	CTE32TP15	●	0°		1.5°	CTE43TP15	●	0°	
2.5°	CTE32TP25	●	1°		2.5°	CTE43TP25	●	1°	
3.5°	CTE32TP35	●	2°		3.5°	CTE43TP35	●	2°	
4.5°	CTE32TP45	●	3°	4.5°	CTE43TP45	●	3°		

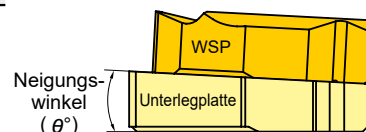

Standard Unterlegplatte im Lieferumfang des Halters enthalten.

## SCHNITTDATENEMPFEHLUNGEN

	Material	Härte	Sorte	Schnittgeschw. (m/min)
P	Allg. Baustahl	≤180HB	VP10MF	150 (70—230)
			VP15TF	100 (60—140)
			VP20RT	80 (60—100)
	C-Stahl Leg. Stahl	180—280HB	VP10MF	140 (80—200)
			VP15TF	100 (60—140)
			VP20RT	80 (60—100)
M	Rostfreier Stahl	≤200HB	VP15TF VP20RT	80 (40—120)
K	Grauguss	Zugfestigkeit ≤350MPa	VP10MF	140 (80—200)
			VP15TF	90 (60—120)

	Material	Härte	Sorte	Schnittgeschw. (m/min)
S	Hitzebeständiger Stahl	—	VP10MF	45 (15—70)
			VP15TF	30 (20—40)
			VP20RT	30 (20—40)
H	Titanlegierung	—	VP10MF	60 (40—80)
			VP15TF	45 (25—65)
			VP20RT	45 (25—65)
H	Gehärtete Werkstoffe	45—55HRC	VP10MF	50 (30—70)
			VP15TF	40 (20—60)

● : Lagerstandard.

AUSWAHL DER UNTERLEGPLATTE > G012  
ERSATZTEILE > N001  
TECHNISCHE DATEN > P001

G019

GEWINDE DREHEN

G

# MMT M-TOLERANZ WSP MIT 3D-GEOMETRIE

## WSP

Form	Bestellbezeichnung	Beschichtet		Steigung		Abmessungen (mm)					Gesamt Schnitttiefe (mm)	Abbildung
		VP15TF	VP20RT	mm	Gang/Zoll	IC	S	PDY	PDX	RE		
Teilprofil 60°	MMT16ERA60-S	●		0.5–1.5	48–16	9.525	3.44	0.8	0.9	0.06	—	
	MMT16ERG60-S	●		1.75–3.0	14–8	9.525	3.44	1.2	1.7	0.23	—	
Teilprofil 55°	MMT16ERA55-S	●			48–16	9.525	3.44	0.8	0.9	0.07	—	
	MMT16ERG55-S	●			14–8	9.525	3.44	1.2	1.7	0.23	—	
Metrisch ISO	MMT16ER100ISO-S	●	●	1.0		9.525	3.44	0.7	0.7	0.13	0.61	
	MMT16ER125ISO-S	●	●	1.25		9.525	3.44	0.8	0.9	0.16	0.77	
	MMT16ER150ISO-S	●	●	1.5		9.525	3.44	0.8	1.0	0.20	0.92	
	MMT16ER175ISO-S	●	●	1.75		9.525	3.44	0.9	1.2	0.22	1.07	
	MMT16ER200ISO-S	●	●	2.0		9.525	3.44	1.0	1.3	0.26	1.23	
	MMT16ER250ISO-S	●	●	2.5		9.525	3.44	1.1	1.5	0.33	1.53	
	MMT16ER300ISO-S	●	●	3.0		9.525	3.44	1.2	1.6	0.40	1.84	
Gewindeform UN-amerikanisch	MMT16ER160UN-S	●			16	9.525	3.44	0.9	1.1	0.23	0.97	
	MMT16ER140UN-S	●			14	9.525	3.44	1.0	1.2	0.26	1.11	
	MMT16ER120UN-S	●			12	9.525	3.44	1.1	1.4	0.30	1.30	
Whitworth für BSW, BSP	MMT16ER190W-S	●			19	9.525	3.44	0.8	1.0	0.18	0.86	
	MMT16ER140W-S	●			14	9.525	3.44	1.0	1.2	0.25	1.16	
	MMT16ER110W-S	●			11	9.525	3.44	1.1	1.5	0.32	1.48	
BSPT	MMT16ER190BSPT-S	●			19	9.525	3.44	0.8	0.9	0.18	0.86	
	MMT16ER140BSPT-S	●			14	9.525	3.44	1.0	1.2	0.25	1.16	
	MMT16ER110BSPT-S	●			11	9.525	3.44	1.1	1.5	0.32	1.48	

## IDENTIFIKATION

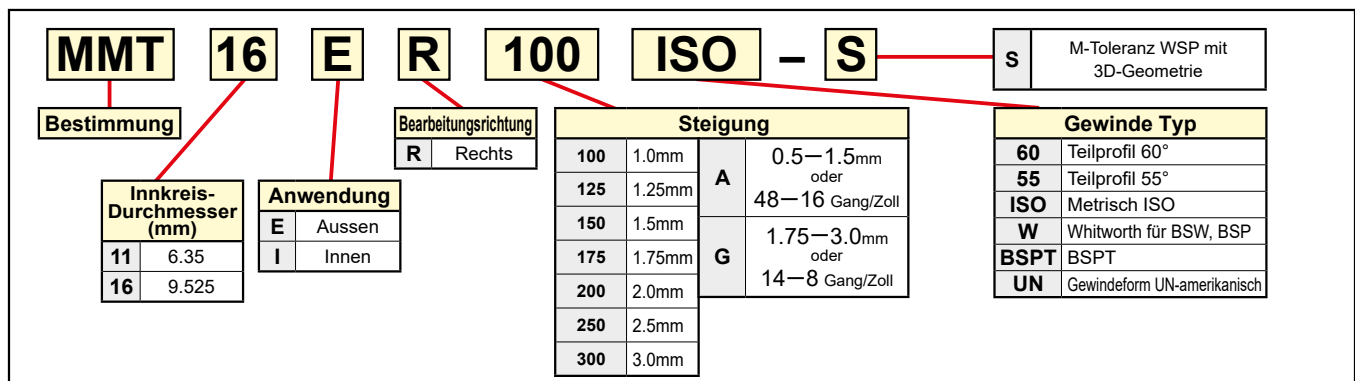

# MMT G-TOLERANZ WSP

## WSP

Form	Gewinde-toleranz	Bestellbezeichnung	Beschichtet		Steigung		Abmessungen (mm)					Gesamt Schnitttiefe (mm)	Abbildung
			VP10MF	VP15TF	mm	Gang/Zoll	IC	S	PDY	PDX	RE		
Teilprofil 60°	—	MMT16ERA60	●	●	0.5–1.5	48–16	9.525	3.44	0.8	0.9	0.05	—	
		MMT16ERG60	●	●	1.75–3.0	14–8	9.525	3.44	1.2	1.7	0.27	—	
		MMT16ERAG60	●	●	0.5–3.0	48–8	9.525	3.44	1.2	1.7	0.08	—	
		MMT22ERN60	●	●	3.5–5.0	7–5	12.7	4.64	1.7	2.5	0.53	—	
Teilprofil 55°	—	MMT16ERA55	●	●		48–16	9.525	3.44	0.8	0.9	0.05	—	
		MMT16ERG55	●	●		14–8	9.525	3.44	1.2	1.7	0.21	—	
		MMT16ERAG55	●	●		48–8	9.525	3.44	1.2	1.7	0.07	—	
		MMT22ERN55	●	●		7–5	12.7	4.64	1.7	2.5	0.44	—	
Metrisch ISO 6g	—	MMT16ER050ISO	●	●	0.5		9.525	3.44	0.6	0.4	0.06	0.31	
		MMT16ER075ISO	●	●	0.75		9.525	3.44	0.6	0.6	0.10	0.46	
		MMT16ER100ISO	●	●	1.0		9.525	3.44	0.7	0.7	0.16	0.61	
		MMT16ER125ISO	●	●	1.25		9.525	3.44	0.8	0.9	0.19	0.77	
		MMT16ER150ISO	●	●	1.5		9.525	3.44	0.8	1.0	0.23	0.92	
		MMT16ER175ISO	●	●	1.75		9.525	3.44	0.9	1.2	0.21	1.07	
		MMT16ER200ISO	●	●	2.0		9.525	3.44	1.0	1.3	0.31	1.23	
		MMT16ER250ISO	●	●	2.5		9.525	3.44	1.1	1.5	0.32	1.53	
		MMT16ER300ISO	●	●	3.0		9.525	3.44	1.2	1.6	0.46	1.84	
		MMT22ER350ISO	●	●	3.5		12.7	4.64	1.6	2.3	0.45	2.15	
		MMT22ER400ISO	●	●	4.0		12.7	4.64	1.6	2.3	0.52	2.45	
		MMT22ER450ISO	●	●	4.5		12.7	4.64	1.7	2.4	0.58	2.76	
		MMT22ER500ISO	●	●	5.0		12.7	4.64	1.7	2.5	0.63	3.07	

G

GEWINDE DREHEN

## IDENTIFIKATION

<b>MMT</b>	<b>16</b>	<b>E</b>	<b>R</b>	<b>050</b>	<b>ISO</b>																																																																
<b>Bestimmung</b>	<b>Innenkreis Durchmesser (mm)</b>	<b>Anwendung</b>	<b>Bearbeitungsrichtung</b>	<b>Steigung</b>	<b>Gewinde Typ</b>																																																																
	11 6.35 16 9.525 22 12.7	E Aussen I Innen	R Rechts	<table border="1"> <tr> <td>050</td> <td>0.5mm</td> <td rowspan="3">A</td> <td rowspan="3">0.5–1.5mm oder 48–16 Gang/Zoll</td> </tr> <tr> <td>075</td> <td>0.75mm</td> </tr> <tr> <td>100</td> <td>1.0mm</td> </tr> <tr> <td>125</td> <td>1.25mm</td> <td rowspan="3">G</td> <td rowspan="3">1.75–3.0mm oder 14–8 Gang/Zoll</td> </tr> <tr> <td>150</td> <td>1.5mm</td> </tr> <tr> <td>175</td> <td>1.75mm</td> </tr> <tr> <td>200</td> <td>2.0mm</td> <td rowspan="3">AG</td> <td rowspan="3">0.5–3.0mm oder 48–8 Gang/Zoll</td> </tr> <tr> <td>250</td> <td>2.5mm</td> </tr> <tr> <td>300</td> <td>3.0mm</td> </tr> <tr> <td>350</td> <td>3.5mm</td> <td rowspan="3">N</td> <td rowspan="3">3.5–5.0mm oder 7–5 Gang/Zoll</td> </tr> <tr> <td>400</td> <td>4.0mm</td> </tr> <tr> <td>450</td> <td>4.5mm</td> </tr> <tr> <td>500</td> <td>5.0mm</td> <td></td> <td></td> </tr> </table>	050	0.5mm	A	0.5–1.5mm oder 48–16 Gang/Zoll	075	0.75mm	100	1.0mm	125	1.25mm	G	1.75–3.0mm oder 14–8 Gang/Zoll	150	1.5mm	175	1.75mm	200	2.0mm	AG	0.5–3.0mm oder 48–8 Gang/Zoll	250	2.5mm	300	3.0mm	350	3.5mm	N	3.5–5.0mm oder 7–5 Gang/Zoll	400	4.0mm	450	4.5mm	500	5.0mm			<table border="1"> <tr> <td>60</td> <td>Teilprofil 60°</td> </tr> <tr> <td>55</td> <td>Teilprofil 55°</td> </tr> <tr> <td>ISO</td> <td>Metrisch ISO</td> </tr> <tr> <td>W</td> <td>Whitworth für BSW, BSP</td> </tr> <tr> <td>BSPT</td> <td>BSPT</td> </tr> <tr> <td>UN</td> <td>Gewindeform UN-amerikanisch</td> </tr> <tr> <td>RD</td> <td>Rund - DIN 405</td> </tr> <tr> <td>TR</td> <td>ISO Trapez 30°</td> </tr> <tr> <td>ACME</td> <td>Gewindeform ACME-amerikanisch</td> </tr> <tr> <td>UNJ</td> <td>UNJ</td> </tr> <tr> <td>APBU</td> <td>API Rohrgewinde</td> </tr> <tr> <td>APRD</td> <td>API Gehäuse und Welle</td> </tr> <tr> <td>NPT</td> <td>NPT</td> </tr> <tr> <td>NPTF</td> <td>NPTF</td> </tr> </table>	60	Teilprofil 60°	55	Teilprofil 55°	ISO	Metrisch ISO	W	Whitworth für BSW, BSP	BSPT	BSPT	UN	Gewindeform UN-amerikanisch	RD	Rund - DIN 405	TR	ISO Trapez 30°	ACME	Gewindeform ACME-amerikanisch	UNJ	UNJ	APBU	API Rohrgewinde	APRD	API Gehäuse und Welle	NPT	NPT	NPTF	NPTF
050	0.5mm	A	0.5–1.5mm oder 48–16 Gang/Zoll																																																																		
075	0.75mm																																																																				
100	1.0mm																																																																				
125	1.25mm	G	1.75–3.0mm oder 14–8 Gang/Zoll																																																																		
150	1.5mm																																																																				
175	1.75mm																																																																				
200	2.0mm	AG	0.5–3.0mm oder 48–8 Gang/Zoll																																																																		
250	2.5mm																																																																				
300	3.0mm																																																																				
350	3.5mm	N	3.5–5.0mm oder 7–5 Gang/Zoll																																																																		
400	4.0mm																																																																				
450	4.5mm																																																																				
500	5.0mm																																																																				
60	Teilprofil 60°																																																																				
55	Teilprofil 55°																																																																				
ISO	Metrisch ISO																																																																				
W	Whitworth für BSW, BSP																																																																				
BSPT	BSPT																																																																				
UN	Gewindeform UN-amerikanisch																																																																				
RD	Rund - DIN 405																																																																				
TR	ISO Trapez 30°																																																																				
ACME	Gewindeform ACME-amerikanisch																																																																				
UNJ	UNJ																																																																				
APBU	API Rohrgewinde																																																																				
APRD	API Gehäuse und Welle																																																																				
NPT	NPT																																																																				
NPTF	NPTF																																																																				



# MMT G-TOLERANZ WSP

WSP

Form	Gewinde-toleranz	Bestellbezeichnung	Beschichtet		Steigung		Abmessungen (mm)					Gesamt Schnitttiefe (mm)	Abbildung
			VP10MF	VP15TF	mm	Gang/Zoll	IC	S	PDY	PDX	RE		
Gewindeform UN-amerikanisch	2A	MMT16ER320UN	●			32	9.525	3.44	0.6	0.6	0.09	0.49	
		MMT16ER280UN	●			28	9.525	3.44	0.6	0.7	0.10	0.56	
		MMT16ER240UN	●			24	9.525	3.44	0.7	0.8	0.16	0.65	
		MMT16ER200UN	●			20	9.525	3.44	0.8	0.9	0.19	0.78	
		MMT16ER180UN	●			18	9.525	3.44	0.8	1.0	0.21	0.87	
		MMT16ER160UN	●	●		16	9.525	3.44	0.9	1.1	0.24	0.97	
		MMT16ER140UN	●	●		14	9.525	3.44	1.0	1.2	0.22	1.11	
		MMT16ER130UN	★			13	9.525	3.44	1.0	1.3	0.24	1.20	
		MMT16ER120UN	●	●		12	9.525	3.44	1.1	1.4	0.32	1.30	
		MMT16ER110UN	★			11	9.525	3.44	1.1	1.5	0.29	1.42	
		MMT16ER100UN	●			10	9.525	3.44	1.1	1.5	0.32	1.56	
		MMT16ER090UN	★			9	9.525	3.44	1.2	1.7	0.35	1.73	
		MMT16ER080UN	●			8	9.525	3.44	1.2	1.6	0.48	1.95	
		MMT22ER070UN	●			7	12.7	4.64	1.6	2.3	0.47	2.22	
		MMT22ER060UN	●			6	12.7	4.64	1.6	2.3	0.53	2.60	
MMT22ER050UN	●			5	12.7	4.64	1.7	2.5	0.64	3.12			
Whitworth für BSW, BSP	Mittel	MMT16ER280W	●			28	9.525	3.44	0.6	0.7	0.09	0.58	
		MMT16ER260W	●			26	9.525	3.44	0.7	0.8	0.10	0.63	
		MMT16ER200W	●			20	9.525	3.44	0.8	0.9	0.18	0.81	
		MMT16ER190W	●	●		19	9.525	3.44	0.8	1.0	0.19	0.86	
		MMT16ER180W	●			18	9.525	3.44	0.8	1.0	0.20	0.90	
		MMT16ER160W	●			16	9.525	3.44	0.9	1.1	0.23	1.02	
		MMT16ER140W	●	●		14	9.525	3.44	1.0	1.2	0.26	1.16	
		MMT16ER120W	★			12	9.525	3.44	1.1	1.4	0.30	1.36	
		MMT16ER110W	●	●		11	9.525	3.44	1.1	1.5	0.33	1.48	
		MMT16ER100W	★			10	9.525	3.44	1.1	1.5	0.37	1.63	
		MMT16ER090W	★			9	9.525	3.44	1.2	1.7	0.34	1.81	
		MMT16ER080W	●			8	9.525	3.44	1.2	1.5	0.39	2.03	
		MMT22ER070W	●			7	12.7	4.64	1.6	2.3	0.46	2.32	
		MMT22ER060W	●			6	12.7	4.64	1.6	2.3	0.53	2.71	
MMT22ER050W	●			5	12.7	4.64	1.7	2.4	0.66	3.25			
BSPT	Standard BSPT	MMT16ER280BSPT	●			28	9.525	3.44	0.6	0.6	0.09	0.58	
		MMT16ER190BSPT	●	●		19	9.525	3.44	0.8	0.9	0.14	0.86	
		MMT16ER140BSPT	●	●		14	9.525	3.44	1.0	1.2	0.26	1.16	
		MMT16ER110BSPT	●	●		11	9.525	3.44	1.1	1.5	0.33	1.48	
Rund-DIN 405	7h	MMT16ER100RD	●			10	9.525	3.44	1.1	1.2	0.60	1.27	
		MMT16ER080RD	●			8	9.525	3.44	1.4	1.3	0.75	1.59	
		MMT16ER060RD	●			6	9.525	3.44	1.5	1.7	1.00	2.12	
		MMT22ER040RD	●			4	9.525	3.44	2.2	2.3	1.51	3.18	

GEWINDE DREHEN

G

● : Lagerstandard. ★ : Lagerstandard in Japan.  
(5 WSP je VPE)



# WSP

Form	Gewinde- toleranz	Bestellbezeichnung	Beschichtet VP10MF	Steigung		Abmessungen (mm)					Gesamt Schnitttiefe (mm)	Abbildung
				mm	Gang/Zoll	IC	S	PDY	PDX	RE		
ISO Trapez 30°	7e	MMT16ER150TR	●	1.5		9.525	3.44	1.0	1.1	0.08	0.90	<p>Kein Vollprofil PNA 30° (für Transmissions- schrauben)</p>
		MMT16ER200TR	●	2.0		9.525	3.44	1.1	1.3	0.15	1.25	
		MMT16ER300TR	●	3.0		9.525	3.44	1.3	1.5	0.15	1.75	
		MMT22ER400TR	●	4.0		12.7	4.64	1.7	1.9	0.15	2.25	
		MMT22ER500TR	●	5.0		12.7	4.64	2.1	2.5	0.15	2.75	
Gewindeform ACME-amerikanisch	3G	MMT16ER120ACME	●		12	9.525	3.44	1.1	1.2	0.08	1.19	<p>Kein Vollprofil PNA 29° (für Transmissions- schrauben)</p>
		MMT16ER100ACME	●		10	9.525	3.44	1.3	1.4	0.08	1.52	
		MMT16ER080ACME	●		8	9.525	3.44	1.4	1.5	0.10	1.84	
		MMT22ER060ACME	●		6	12.7	4.64	1.8	2.1	0.10	2.37	
		MMT22ER050ACME	●		5	12.7	4.64	2.0	2.3	0.10	2.79	
UNJ	3A	MMT16ER320UNJ	●		32	9.525	3.44	0.6	0.7	0.13	0.46	<p>Vollprofil</p>
		MMT16ER280UNJ	●		28	9.525	3.44	0.7	0.7	0.14	0.52	
		MMT16ER240UNJ	●		24	9.525	3.44	0.7	0.8	0.17	0.61	
		MMT16ER200UNJ	●		20	9.525	3.44	0.8	0.9	0.20	0.73	
		MMT16ER180UNJ	●		18	9.525	3.44	0.8	1.0	0.22	0.81	
		MMT16ER160UNJ	●		16	9.525	3.44	0.9	1.1	0.25	0.92	
		MMT16ER140UNJ	●		14	9.525	3.44	1.0	1.2	0.29	1.05	
		MMT16ER120UNJ	●		12	9.525	3.44	1.1	1.3	0.33	1.22	
		MMT16ER100UNJ	★		10	9.525	3.44	1.2	1.5	0.40	1.47	
		MMT16ER080UNJ	★		8	9.525	3.44	1.2	1.6	0.51	1.83	
API Rohrgewinde	Standard API	MMT22ER050APBU	★		5	12.7	4.64	3.1	1.9	0.18	1.55	<p>Vollprofil</p>
API Gehäuse und Welle	Standard API RD	MMT16ER100APRD	●		10	9.525	3.44	1.2	1.4	0.34	1.41	<p>Vollprofil</p>
		MMT16ER080APRD	●		8	9.525	3.44	1.3	1.5	0.41	1.81	
Gewindeform NPT-amerikanisch	Standard NPT	MMT16ER270NPT	★		27	9.525	3.44	0.7	0.8	0.04	0.66	<p>Vollprofil</p>
		MMT16ER180NPT	●		18	9.525	3.44	0.8	1.0	0.08	1.01	
		MMT16ER140NPT	●		14	9.525	3.44	0.9	1.2	0.09	1.33	
		MMT16ER115NPT	●		11.5	9.525	3.44	1.1	1.5	0.11	1.64	
		MMT16ER080NPT	●		8	9.525	3.44	1.3	1.8	0.14	2.42	
Gewindeform NPTF-amerikanisch	2 Klasse	MMT16ER270NPTF	★		27	9.525	3.44	0.7	0.8	0.04	0.64	<p>Vollprofil</p>
		MMT16ER180NPTF	●		18	9.525	3.44	0.8	1.0	0.04	1.00	
		MMT16ER140NPTF	●		14	9.525	3.44	0.9	1.2	0.04	1.35	
		MMT16ER115NPTF	●		11.5	9.525	3.44	1.1	1.5	0.04	1.63	
		MMT16ER080NPTF	●		8	9.525	3.44	1.3	1.8	0.04	2.38	

G  
GEWINDE DREHEN

# AUSSENGEWINDE DREHEN

# MT HALTER

- Spannfingerklemmung.
- Positiver Schnitt für beste Schlichtoberfläche.
- Gewindesteigung  $\leq 4.5\text{mm}$

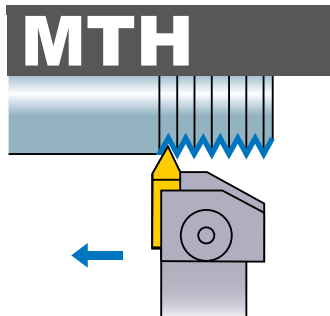

## Aussengewinde drehen



Abb. zeigt Rechtsausführung.

Hinweis 1) Bearbeitung in entgegengesetzter Richtung ist nicht möglich.

Bestellbezeichnung	Lager		WSP Bezeichnung	Abmessungen (mm)							Spannfinger	Spannschraube *	Feder	Schlüssel	
	R	L		H	B	LF	HF	WF	HBKW	HBH					HBL
<b>MTHR/L1616H4</b>	★	★	MTTR/L43○○○○	16	16	100	16	13.8	3	3	21	MTK1R/L	HBH06020	MES3	HKY40R
<b>MTHR/L2020K4</b>	●	★		20	20	125	20	17.8	—	—	—	MTK1R/L	HBH06020	MES3	HKY40R
<b>MTHR/L2525M4</b>	●	★		25	25	150	25	22.8	—	—	—	MTK1R/L	HBH06020	MES3	HKY40R

\* Spannmoment (N • m) : HBH06020=7.0

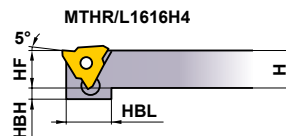
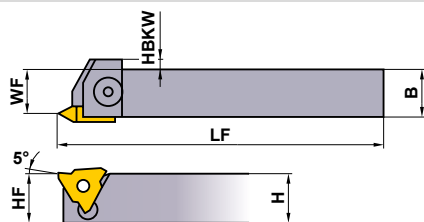
# MT1

## Aussengewinde drehen



Abb. zeigt Rechtsausführung.

Hinweis 1) Bearbeitung in entgegengesetzter Richtung ist nicht möglich.

Bestellbezeichnung	Lager		WSP Bezeichnung	Abmessungen (mm)							Spannfinger	Spannschraube *	Feder	Schlüssel
	R	L		H	B	LF	LH	HF	WF					
<b>MT1R/L2020K4</b>	★	★	MTTR/L43○○○○	20	20	125	30	20	25	MTK1R/L	HBH06020	MES3	HKY40R	
<b>MT1R/L2525M4</b>	★	★		25	25	150	30	25	32	MTK1R/L	HBH06020	MES3	HKY40R	
<b>MT1R/L3232P4</b>	★	★		32	32	170	30	32	40	MTK1R/L	HBH06020	MES3	HKY40R	

\* Spannmoment (N • m) : HBH06020=7.0

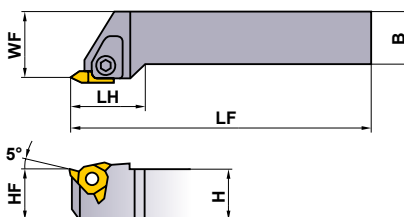
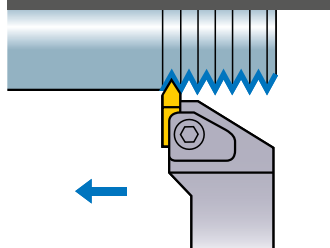
## SCHNITTDATENEMPFEHLUNGEN

Material	Härte	Sorte	Schnittgeschw. (m/min)
P Allg. Baustahl	$\leq 180\text{HB}$	UP20M	140 (100–180)
		NX2525	200 (150–250)
		UTi20T	120 (100–150)
C-Stahl Leg. Stahl	180–280HB	UP20M	120 (100–150)
		NX2525	170 (150–200)
		UTi20T	100 (70–120)

Material	Härte	Sorte	Schnittgeschw. (m/min)
M Rostfreier Stahl	$\leq 200\text{HB}$	UP20M	120 (80–150)
		UTi20T	100 (70–130)
K Grauguss	Zugfestigkeit $\leq 350\text{MPa}$	UP20M	80 (60–100)
		UTi20T	80 (60–100)
		HTi10	100 (70–130)

● : Lagerstandard. ★ : Lagerstandard in Japan.  
(10 WSP je VPE)

# WSP

Form	Bestellbezeichnung	Klasse	Beschichtet		Cermet		Hartmetall		Steigung mm (Gang/Zoll)	Abmessungen (mm)			Abbildung
			UP20M	NX2525	UTi20T	HTi10	IC	S		RE			
Teilprofil 60°	<b>MTTR436000</b>	G		●	●			-0.8	12.7	4.76	0	<p>Abb. zeigt rechte WSP.</p>	
	<b>MTTR436001</b>	G	★	●	●	★		1.0-1.75	12.7	4.76	0.1		
	<b>MTTL436001</b>	G	★		●	★		1.0-1.75	12.7	4.76	0.1		
	<b>MTTR436002</b>	G	★	●	●	★		2.0-2.5	12.7	4.76	0.2		
	<b>MTTL436002</b>	G		●	●			2.0-2.5	12.7	4.76	0.2		
	<b>MTTR436003</b>	G	★	●	●	★		3.0-3.5	12.7	4.76	0.3		
	<b>MTTL436003</b>	G		●	●			3.0-3.5	12.7	4.76	0.3		
	<b>MTTR436004</b>	G		●	●			4.0-4.5	12.7	4.76	0.4		
Teilprofil 55°	<b>MTTR435501</b>	G		●	●	★		(28-10)	12.7	4.76	0.1	<p>Nur Rechtsausführung.</p>	
	<b>MTTR435502</b>	G		●	●			(16-8)	12.7	4.76	0.2		
	<b>MTTR435503</b>	G		●	●			(11-8)	12.7	4.76	0.3		

## STANDARD SCHNITTIEFE

- Die rechte Tabelle zeigt die empfohlenen Schnitttiefen für metr. Aussengewinde (ISO).
- Bei Verwendung von Cermet-Sorten, erhöhen Sie bitte die Anzahl der Durchgänge um 2-3 Mal.

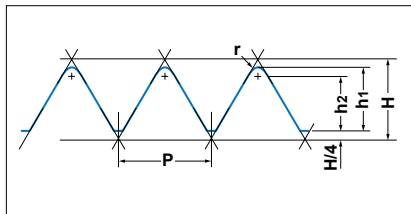

## METRISCHES SCHRAUBENGWINDE

P (Steigung)	0.75	1.00	1.25	1.50	1.75	2.00	2.50	3.00	3.50	4.00	4.50	
<b>h1</b>	0.46	0.61	0.77	0.92	1.07	1.23	1.53	1.84	2.15	2.45	2.76	
<b>h2</b>	0.35	0.47	0.59	0.70	0.82	0.94	1.17	1.41	1.65	1.87	2.11	
<b>r (Eckenradius)</b>	0.11	0.14	0.18	0.22	0.25	0.29	0.36	0.43	0.50	0.58	0.65	
Anzahl der Durchgänge	1	0.18	0.20	0.20	0.25	0.25	0.25	0.30	0.30	0.35	0.35	0.40
	2	0.13	0.15	0.18	0.20	0.20	0.25	0.25	0.25	0.30	0.30	0.35
	3	0.10	0.10	0.12	0.15	0.20	0.20	0.20	0.25	0.25	0.25	0.30
	4	0.05	0.10	0.12	0.15	0.15	0.15	0.20	0.20	0.20	0.25	0.25
	5		0.06	0.10	0.10	0.12	0.15	0.15	0.20	0.20	0.25	0.25
	6			0.05	0.07	0.10	0.10	0.10	0.15	0.20	0.20	0.20
	7					0.05	0.08	0.10	0.15	0.15	0.20	0.20
	8						0.05	0.10	0.10	0.15	0.15	0.15
	9							0.08	0.10	0.10	0.15	0.15
	10							0.05	0.09	0.10	0.10	0.15
	11								0.05	0.10	0.10	0.10
	12									0.05	0.10	0.10
	13										0.05	0.10
	14											0.06

Hinweis 1) Der erste Schnitt verursacht eine hohe Belastung auf der Schneidkante, um Beschädigungen zu vermeiden. Reduzieren Sie die Schnitttiefe auf 0.4-0.5mm.

# INNENGEWINDE DREHEN

## MMTI AUSFÜHRUNG BOHRSTANGEN

- Min. Durchmesser 13mm.
- Verschiedenste WSP-Formen und -Sorten.
- Präzisions-WSP.
- Verfügbar mit einer Wiper Schneidkantenausführung um eine exakte Gewindeschneidgeometrie zu erhalten.
- Veränderung des Anstellwinkels durch Auswechslung der Unterlegplatte.

### MMTI

### Innengewinde drehen

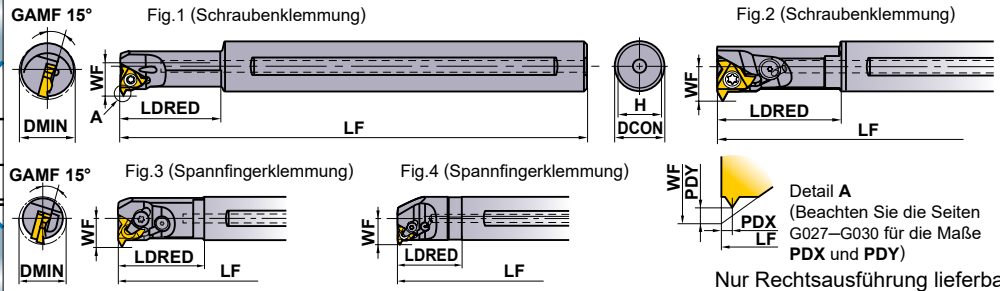

Bestellbezeichnung	Lager R	WSP Bezeichnung	Anstellwinkel	Abmessungen (mm)						Spann- finger	Spann- schraube	Spreng- ring	① Schr. f. U- platte ② Versenkte Schraube	Unterleg- platte	Schlüssel	Fig
				DCON	LF	LDRED	WF	H	DMIN							
MMTIR1316AK11-SP15	●	MMT111R	1.5°	16	125	25	8.7	15	13	—	TS25	—	—	—	①TKY08F	1
MMTIR1316AK11-SP25	★		2.5°	16	125	25	8.7	15	13	—	TS25	—	—	—	①TKY08F	1
MMTIR1316AK11-SP35	★		3.5°	16	125	25	8.7	15	13	—	TS25	—	—	—	①TKY08F	1
MMTIR1516AM11-SP15	●		1.5°	16	150	32	9.7	15	15	—	TS25	—	—	—	①TKY08F	1
MMTIR1516AM11-SP25	★		2.5°	16	150	32	9.7	15	15	—	TS25	—	—	—	①TKY08F	1
MMTIR1516AM11-SP35	★		3.5°	16	150	32	9.7	15	15	—	TS25	—	—	—	①TKY08F	1
MMTIR1916AM16-SP15	●	MMT161R	1.5°	16	150	40	12.2	15	19	—	CS350860T	—	—	—	①TKY15F	2
MMTIR1916AM16-SP25	★		2.5°	16	150	40	12.2	15	19	—	CS350860T	—	—	—	①TKY15F	2
MMTIR1916AM16-SP35	★		3.5°	16	150	40	12.2	15	19	—	CS350860T	—	—	—	①TKY15F	2
MMTIR2420AQ16-C	●		1.5°	20	180	40	14.2	19	24	SETK51	SETS51	CR4	①HFC03006 ②TFS03006	CTI32TP15	①TKY15F ②HKY20R	3
MMTIR2925AS16-C	●		1.5°	25	250	60	16.7	23.4	29	SETK51	SETS51	CR4	①HFC03006 ②TFS03006	CTI32TP15	①TKY15F ②HKY20R	3
MMTIR3732AS16-C	●		1.5°	32	250	48	20.5	30.4	37	SETK51	SETS51	CR4	①HFC03006 ②TFS03006	CTI32TP15	①TKY15F ②HKY20R	4
MMTIR2420AQ22-SP15	●	MMT221R	1.5°	20	180	50	15.5	19	24	—	TS43	—	—	—	①TKY15F	2
MMTIR2420AQ22-SP25	★		2.5°	20	180	50	15.5	19	24	—	TS43	—	—	—	①TKY15F	2
MMTIR2420AQ22-SP35	★		3.5°	20	180	50	15.5	19	24	—	TS43	—	—	—	①TKY15F	2
MMTIR3025AR22-C	●		1.5°	25	200	38	17.8	23.4	30	SETK61	SETS61	CR5	①HFC04008 ②TFS03006	CTI43TP15	①TKY20F ②HKY25R	4
MMTIR3832AS22-C	●		1.5°	32	250	48	21.8	30.4	38	SETK61	SETS61	CR5	①HFC04008 ②TFS03006	CTI43TP15	①TKY20F ②HKY25R	4
MMTIR4640AT22-C	★		1.5°	40	300	60	26.2	38	46	SETK61	SETS61	CR5	①HFC04008 ②TFS03006	CTI43TP15	①TKY20F ②HKY25R	4

Hinweis 1) Einsetzen weiterer Unterlegplatten (separate Bestellung) in Abhängigkeit des Anstellwinkels.  
 • Halter mit alleiniger Schraubklemmung verwenden keine Unterlegplatten. Bitte bestellen Sie einen Halter mit entsprechendem Anstellwinkel.  
 • Der minimale Bearbeitungsdurchmesser (DMIN) gibt den Innendurchmesser der Bohrung an, nicht den Gewindedurchmesser.  
 \* Spannmoment (N · m) : TS25=1.0, CS350860T=3.5, SETS51=3.5, TS43=3.5, SETS61=5.0, HFC03006=1.5, HFC04008=2.2

### UNTERLEGPLATTE

Anstellwinkel (α°)	Bestellbezeichnung	Lager R	Neigungswinkel (θ°)	Zugehöriger Halter	Anstellwinkel (α°)	Bestellbezeichnung	Lager R	Neigungswinkel (θ°)	Zugehöriger Halter
-1.5°	CTI32TN15	●	-3°	MMTIR ○○○ ○○16-C	-1.5°	CTI43TN15	●	-3°	MMTIR ○○○ ○○22-C
-0.5°	CTI32TN05	●	-2°		-0.5°	CTI43TN05	●	-2°	
0.5°	CTI32TP05	●	-1°		0.5°	CTI43TP05	●	-1°	
1.5°	CTI32TP15	●	0°		1.5°	CTI43TP15	●	0°	
2.5°	CTI32TP25	●	1°		2.5°	CTI43TP25	●	1°	
3.5°	CTI32TP35	●	2°		3.5°	CTI43TP35	●	2°	
4.5°	CTI32TP45	●	3°		4.5°	CTI43TP45	●	3°	

Standard Unterlegplatte im Lieferumfang des Halters enthalten.

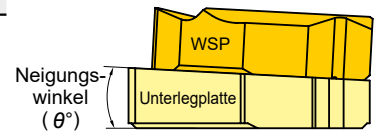

### SCHNITTDATENEMPFEHLUNGEN

Material	Härte	Sorte	Schnittgeschw. (m/min)
P	Allg. Baustahl	VP10MF	150 (70-230)
		VP15TF	100 (60-140)
		VP20RT	80 (60-100)
	C-Stahl Leg. Stahl	VP10MF	140 (80-200)
		VP15TF	100 (60-140)
		VP20RT	80 (60-100)
M	Rostfreier Stahl	VP15TF VP20RT	80 (40-120)
K	Grauguss	VP10MF	140 (80-200)
		VP15TF	90 (60-120)

Material	Härte	Sorte	Schnittgeschw. (m/min)
S	Hitzebeständiger Stahl	VP10MF	45 (15-70)
		VP15TF	30 (20-40)
		VP20RT	—
Titanlegierung	VP10MF	60 (40-80)	
	VP15TF	45 (25-65)	
	VP20RT	—	
H	Gehärtete Werkstoffe	VP10MF VP15TF	50 (30-70) 40 (20-60)

● : Lagerstandard. ★ : Lagerstandard in Japan.  
 (5 WSP je VPE)

AUSWAHL DER UNTERLEGPLATTE > G012  
 BESTELLBEZEICHNUNG FÜR DIE MMT-SERIE > G018

# MMT WSP DER KLASSE M MIT 3D-SPANBRECHERN

## WSP

Form	Bestellbezeichnung	Beschichtet		Steigung		Abmessungen (mm)					Gesamt Schnitttiefe (mm)	Abbildung
		VP15TF	VP20RT	mm	Gang/Zoll	IC	S	PDY	PDX	RE		
Teilprofil 60°	MMT11IRA60-S	●		0.5–1.5	48–16	6.35	3.04	0.8	0.9	0.03	—	
	MMT16IRA60-S	●		0.5–1.5	48–16	9.525	3.44	0.8	0.9	0.03	—	
	MMT16IRG60-S	●		1.75–3.0	14–8	9.525	3.44	1.2	1.7	0.11	—	
Teilprofil 55°	MMT11IRA55-S	●			48–16	6.35	3.04	0.8	0.9	0.07	—	
	MMT16IRA55-S	●			48–16	9.525	3.44	0.8	0.9	0.07	—	
	MMT16IRG55-S	●			14–8	9.525	3.44	1.2	1.7	0.21	—	
Metrisch ISO	MMT11IR100ISO-S	●		1.0		6.35	3.04	0.6	0.7	0.06	0.58	
	MMT11IR125ISO-S	●		1.25		6.35	3.04	0.8	0.9	0.08	0.72	
	MMT11IR150ISO-S	●		1.5		6.35	3.04	0.8	1.0	0.10	0.87	
	MMT16IR100ISO-S	●	●	1.0		9.525	3.44	0.6	0.7	0.06	0.58	
	MMT16IR125ISO-S	●	●	1.25		9.525	3.44	0.8	0.9	0.08	0.72	
	MMT16IR150ISO-S	●	●	1.5		9.525	3.44	0.8	1.0	0.10	0.87	
	MMT16IR175ISO-S	●	●	1.75		9.525	3.44	0.9	1.2	0.11	1.01	
	MMT16IR200ISO-S	●	●	2.0		9.525	3.44	1.0	1.3	0.13	1.15	
	MMT16IR250ISO-S	●	●	2.5		9.525	3.44	1.1	1.5	0.17	1.44	
	MMT16IR300ISO-S	●	●	3.0		9.525	3.44	1.1	1.5	0.20	1.73	
Gewindeform UN-amerikanisch	MMT16IR160UN-S	●			16	9.525	3.44	0.9	1.1	0.11	0.92	
	MMT16IR140UN-S	●			14	9.525	3.44	0.9	1.2	0.12	1.05	
	MMT16IR120UN-S	●			12	9.525	3.44	1.1	1.4	0.14	1.22	
Whitworth für BSW, BSP	MMT16IR190W-S	●			19	9.525	3.44	0.8	1.0	0.18	0.86	
	MMT16IR140W-S	●			14	9.525	3.44	1.0	1.2	0.25	1.16	
	MMT16IR110W-S	●			11	9.525	3.44	1.1	1.5	0.32	1.48	
BSPT	MMT16IR190BSPT-S	●			19	9.525	3.44	0.8	0.9	0.18	0.86	
	MMT16IR140BSPT-S	●			14	9.525	3.44	1.0	1.2	0.25	1.16	
	MMT16IR110BSPT-S	●			11	9.525	3.44	1.1	1.5	0.32	1.48	

G  
GEWINDE DREHEN

## IDENTIFIKATION

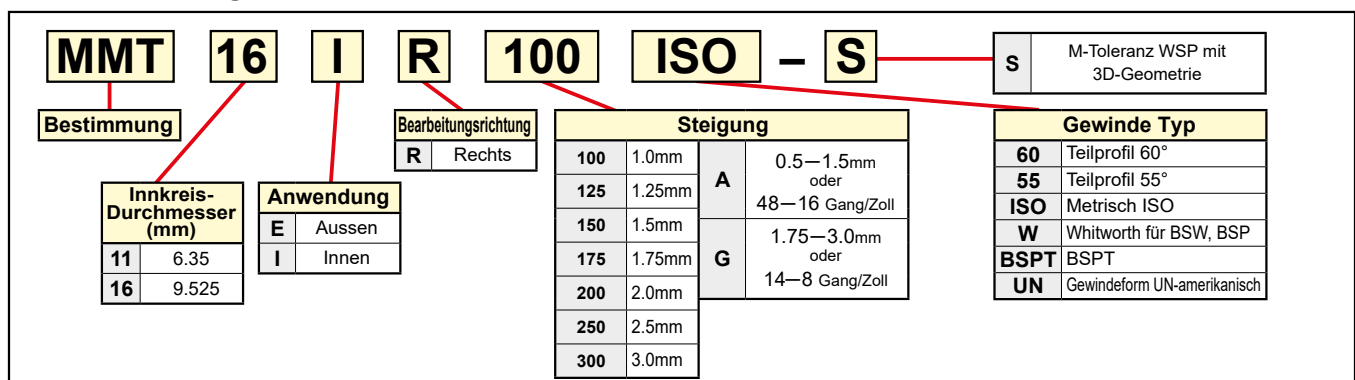

# MMT G-TOLERANZ WSP

## WSP

Form	Gewinde-toleranz	Bestellbezeichnung	Beschichtet		Steigung		Abmessungen (mm)					Gesamt Schnitttiefe (mm)	Abbildung
			VP10MF	VP15TF	mm	Gang/Zoll	IC	S	PDY	PDX	RE		
Teilprofil 60°	—	MMT11IRA60	●	●	0.5—1.5	48—16	6.35	3.04	0.8	0.9	0.05	—	
		MMT16IRA60	●	●	0.5—1.5	48—16	9.525	3.44	0.8	0.9	0.05	—	
		MMT16IRG60	●	●	1.75—3.0	14—8	9.525	3.44	1.2	1.7	0.16	—	
		MMT16IRAG60	●	●	0.5—3.0	48—8	9.525	3.44	1.2	1.7	0.05	—	
		MMT22IRN60	●	●	3.5—5.0	7—5	12.7	4.64	1.7	2.5	0.30	—	
Teilprofil 55°	—	MMT11IRA55	●	●		48—16	6.35	3.04	0.8	0.9	0.05	—	
		MMT16IRA55	●	●		48—16	9.525	3.44	0.8	0.9	0.05	—	
		MMT16IRG55	●	●		14—8	9.525	3.44	1.2	1.7	0.21	—	
		MMT16IRAG55	●	●		48—8	9.525	3.44	1.2	1.7	0.07	—	
		MMT22IRN55	●	●		7—5	12.7	4.64	1.7	2.5	0.44	—	
Metrisch ISO 6H	—	MMT11IR050ISO	●	●	0.5		6.35	3.04	0.6	0.4	0.03	0.29	
		MMT11IR075ISO	●	●	0.75		6.35	3.04	0.6	0.6	0.04	0.43	
		MMT11IR100ISO	●	●	1.0		6.35	3.04	0.6	0.7	0.10	0.58	
		MMT11IR125ISO	●	●	1.25		6.35	3.04	0.8	0.9	0.12	0.72	
		MMT11IR150ISO	●	●	1.5		6.35	3.04	0.8	1.0	0.14	0.87	
		MMT11IR175ISO	●	●	1.75		6.35	3.04	0.9	1.1	0.10	1.01	
		MMT11IR200ISO	●	●	2.0		6.35	3.04	0.9	1.1	0.18	1.15	
		MMT16IR050ISO	●	●	0.5		9.525	3.44	0.6	0.4	0.03	0.29	
		MMT16IR075ISO	●	●	0.75		9.525	3.44	0.6	0.6	0.04	0.43	
		MMT16IR100ISO	●	●	1.0		9.525	3.44	0.6	0.7	0.10	0.58	
		MMT16IR125ISO	●	●	1.25		9.525	3.44	0.8	0.9	0.12	0.72	
		MMT16IR150ISO	●	●	1.5		9.525	3.44	0.8	1.0	0.14	0.87	
		MMT16IR175ISO	●	●	1.75		9.525	3.44	0.9	1.2	0.10	1.01	
		MMT16IR200ISO	●	●	2.0		9.525	3.44	1.0	1.3	0.18	1.15	
		MMT16IR250ISO	●	●	2.5		9.525	3.44	1.1	1.5	0.15	1.44	
		MMT16IR300ISO	●	●	3.0		9.525	3.44	1.1	1.5	0.26	1.73	
		MMT22IR350ISO	●	●	3.5		12.7	4.64	1.6	2.3	0.22	2.02	
		MMT22IR400ISO	●	●	4.0		12.7	4.64	1.6	2.3	0.25	2.31	
		MMT22IR450ISO	●	●	4.5		12.7	4.64	1.6	2.4	0.28	2.60	
MMT22IR500ISO	●	●	5.0		12.7	4.64	1.6	2.3	0.32	2.89			

GEWINDE DREHEN

G

## IDENTIFIKATION

MMT
16
I
R
050
ISO

**Bestimmung**

Innkreis-Durchmesser (mm)	
11	6.35
16	9.525
22	12.7

**Anwendung**

	Aussen	Innen
E	●	
I		●

**Bearbeitungsrichtung**

	Rechts
R	●

**Steigung**

Steigung	Typ	Abmessungen
050 0.5mm	A	0.5—1.5mm oder 48—16 Gang/Zoll
075 0.75mm		
100 1.0mm	G	1.75—3.0mm oder 14—8 Gang/Zoll
125 1.25mm		
150 1.5mm		
175 1.75mm		
200 2.0mm	AG	0.5—3.0mm oder 48—8 Gang/Zoll
250 2.5mm		
300 3.0mm		
350 3.5mm	N	3.5—5.0mm oder 7—5 Gang/Zoll
400 4.0mm		
450 4.5mm		
500 5.0mm		

**Gewinde Typ**

60	Teilprofil 60°
55	Teilprofil 55°
ISO	Metrisch ISO
W	Whitworth für BSW, BSP
BSPT	BSPT
UN	Gewindeform UN-amerikanisch
RD	Rund-DIN 405
TR	ISO Trapez 30°
ACME	Gewindeform ACME-amerikanisch
UNJ	UNJ
APBU	API Rohrgewinde
APRD	API Gehäuse und Welle
NPT	NPT
NPTF	NPTF

● : Lagerstandard. ★ : Lagerstandard in Japan.  
(5 WSP je VPE)



WSP

Form	Gewinde-toleranz	Bestellbezeichnung	Beschichtet		Steigung		Abmessungen (mm)					Gesamt Schnitttiefe (mm)	Abbildung
			VP10MF	VP15TF	mm	Gang/Zoll	IC	S	PDY	PDX	RE		
Gewindeform UN-amerikanisch	2B	MMT11IR320UN	★			32	6.35	3.04	0.6	0.6	0.04	0.46	
		MMT11IR280UN	★			28	6.35	3.04	0.6	0.7	0.05	0.52	
		MMT11IR240UN	●			24	6.35	3.04	0.7	0.8	0.09	0.61	
		MMT11IR200UN	●			20	6.35	3.04	0.8	0.9	0.11	0.73	
		MMT11IR180UN	●			18	6.35	3.04	0.8	1.0	0.12	0.81	
		MMT11IR160UN	●			16	6.35	3.04	0.9	1.1	0.14	0.92	
		MMT11IR140UN	●			14	6.35	3.04	0.9	1.1	0.11	1.05	
		MMT16IR320UN	●			32	9.525	3.44	0.6	0.6	0.04	0.46	
		MMT16IR280UN	●			28	9.525	3.44	0.6	0.7	0.05	0.52	
		MMT16IR240UN	●			24	9.525	3.44	0.7	0.8	0.09	0.61	
		MMT16IR200UN	●			20	9.525	3.44	0.8	0.9	0.11	0.73	
		MMT16IR180UN	●			18	9.525	3.44	0.8	1.0	0.12	0.81	
		MMT16IR160UN	● ●			16	9.525	3.44	0.9	1.1	0.14	0.92	
		MMT16IR140UN	● ●			14	9.525	3.44	0.9	1.2	0.11	1.05	
		MMT16IR130UN	● ●			13	9.525	3.44	1.0	1.3	0.10	1.13	
		MMT16IR120UN	● ●			12	9.525	3.44	1.1	1.4	0.18	1.22	
		MMT16IR110UN	●			11	9.525	3.44	1.1	1.5	0.13	1.33	
		MMT16IR100UN	●			10	9.525	3.44	1.1	1.5	0.15	1.47	
		MMT16IR090UN	●			9	9.525	3.44	1.2	1.7	0.17	1.63	
		MMT16IR080UN	●			8	9.525	3.44	1.1	1.5	0.27	1.83	
MMT22IR070UN	●			7	12.7	4.64	1.6	2.3	0.23	2.09			
MMT22IR060UN	●			6	12.7	4.64	1.6	2.3	0.26	2.44			
MMT22IR050UN	●			5	12.7	4.64	1.6	2.3	0.32	2.93			
Whitworth für BSW, BSP	Mittel	MMT11IR190W	●			19	6.35	3.04	0.8	1.0	0.19	0.86	
		MMT11IR140W	●			14	6.35	3.04	0.9	1.1	0.26	1.16	
		MMT16IR280W	●			28	9.525	3.44	0.6	0.7	0.09	0.58	
		MMT16IR260W	●			26	9.525	3.44	0.7	0.8	0.10	0.63	
		MMT16IR200W	●			20	9.525	3.44	0.8	0.9	0.18	0.81	
		MMT16IR190W	● ●			19	9.525	3.44	0.8	1.0	0.19	0.86	
		MMT16IR180W	●			18	9.525	3.44	0.8	1.0	0.20	0.90	
		MMT16IR160W	●			16	9.525	3.44	0.9	1.1	0.23	1.02	
		MMT16IR140W	● ●			14	9.525	3.44	1.0	1.2	0.26	1.16	
		MMT16IR120W	●			12	9.525	3.44	1.1	1.4	0.30	1.36	
		MMT16IR110W	● ●			11	9.525	3.44	1.1	1.5	0.33	1.48	
		MMT16IR100W	●			10	9.525	3.44	1.1	1.5	0.37	1.63	
		MMT16IR090W	●			9	9.525	3.44	1.2	1.7	0.34	1.81	
		MMT16IR080W	●			8	9.525	3.44	1.2	1.5	0.39	2.03	
		MMT22IR070W	●			7	12.7	4.64	1.6	2.3	0.46	2.32	
		MMT22IR060W	●			6	12.7	4.64	1.6	2.3	0.53	2.71	
MMT22IR050W	●			5	12.7	4.64	1.7	2.4	0.66	3.25			
BSPT	Standard BSPT	MMT11IR190BSPT	●			19	6.35	3.04	0.8	0.9	0.14	0.86	
		MMT11IR140BSPT	●			14	6.35	3.04	0.9	1.0	0.26	1.16	
		MMT16IR190BSPT	★ ★			19	9.525	3.44	0.8	0.9	0.14	0.86	
		MMT16IR140BSPT	★ ★			14	9.525	3.44	1.0	1.2	0.26	1.16	
		MMT16IR110BSPT	★ ★			11	9.525	3.44	1.1	1.5	0.33	1.48	
Rund-DIN 405	7H	MMT16IR100RD	●			10	9.525	3.44	1.1	1.2	0.55	1.27	
		MMT16IR080RD	●			8	9.525	3.44	1.4	1.4	0.70	1.59	
		MMT16IR060RD	●			6	9.525	3.44	1.4	1.5	0.93	2.12	
		MMT22IR040RD	●			4	12.7	4.64	2.2	2.3	1.40	3.18	

G  
GEWINDE DREHEN



# MMT G-TOLERANZ WSP

## WSP

Form	Gewinde-toleranz	Bestellbezeichnung	Beschichtet VP10MF	Steigung		Abmessungen (mm)					Gesamt Schnitttiefe (mm)	Abbildung
				mm	Gang/Zoll	IC	S	PDY	PDX	RE		
ISO Trapez 30°	7H	MMT16IR150TR	●	1.5		9.525	3.44	1.0	1.1	0.08	0.90	<p>Kein Vollprofil (für Transmissions-schrauben)</p>
		MMT16IR200TR	●	2.0		9.525	3.44	1.1	1.3	0.15	1.25	
		MMT16IR300TR	●	3.0		9.525	3.44	1.3	1.5	0.15	1.75	
		MMT22IR400TR	●	4.0		12.7	4.64	1.7	1.9	0.15	2.25	
		MMT22IR500TR	●	5.0		12.7	4.64	2.1	2.5	0.15	2.75	
Gewindeform ACME-amerikanisch	3G	MMT16IR120ACME	●		12	9.525	3.44	1.2	1.3	0.05	1.19	<p>Kein Vollprofil (für Transmissions-schrauben)</p>
		MMT16IR100ACME	●		10	9.525	3.44	1.2	1.3	0.08	1.52	
		MMT16IR080ACME	●		8	9.525	3.44	1.4	1.5	0.10	1.84	
		MMT22IR060ACME	●		6	12.7	4.64	1.8	2.1	0.10	2.37	
		MMT22IR050ACME	●		5	12.7	4.64	2.0	2.3	0.10	2.79	
UNJ												<p>Für die Herstellung eines UNJ Innengewindes bohren Sie mit angemessenem Durchmesser vor und bearbeiten Sie das Gewinde nach Gewindeform UN - amerikanisch 60°. In diesem Fall können keine Vollprofil WSP eingesetzt werden.</p>
API Rohrgewinde	Standard API	MMT22IR050APBU	●		5	12.7	4.64	2.8	1.9	0.18	1.55	<p>Vollprofil</p>
API Gehäuse und Welle	Standard API RD	MMT16IR100APRD	●		10	9.525	3.44	1.2	1.4	0.34	1.41	<p>Vollprofil</p>
		MMT16IR080APRD	●		8	9.525	3.44	1.3	1.5	0.41	1.81	
Gewindeform NPT-amerikanisch	Standard NPT	MMT16IR270NPT	★		27	9.525	3.44	0.7	0.8	0.04	0.66	<p>Vollprofil</p>
		MMT16IR180NPT	★		18	9.525	3.44	0.8	1.0	0.08	1.01	
		MMT16IR140NPT	●		14	9.525	3.44	0.9	1.2	0.09	1.33	
		MMT16IR115NPT	●		11.5	9.525	3.44	1.1	1.5	0.11	1.64	
		MMT16IR080NPT	●		8	9.525	3.44	1.3	1.8	0.14	2.42	
Gewindeform NPTF-amerikanisch	2 Klasse	MMT16IR140NPTF	★		14	9.525	3.44	0.9	1.2	0.04	1.35	<p>Vollprofil</p>
		MMT16IR115NPTF	★		11.5	9.525	3.44	1.1	1.5	0.04	1.63	
		MMT16IR080NPTF	★		8	9.525	3.44	1.3	1.8	0.04	2.38	

G

GEWINDE DREHEN

# MICRO-MINI TWIN

## CT-STANDARD

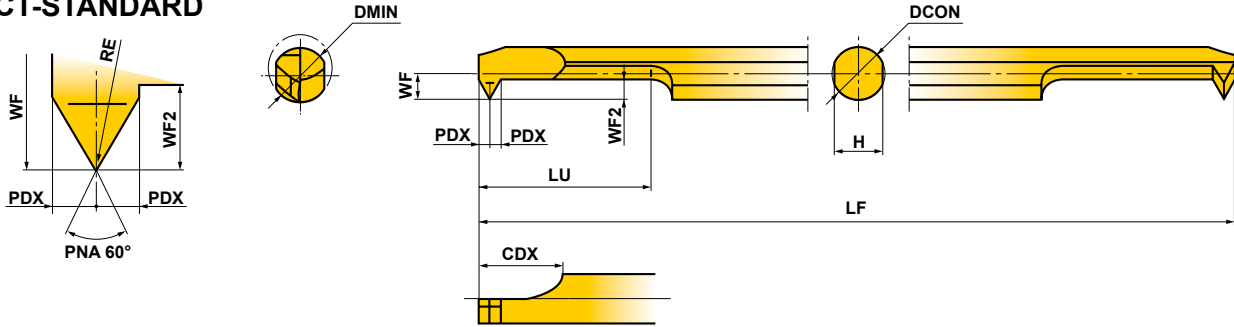

Bestellbezeichnung	Lager		Spanbrecher	Gewinde				Abmessungen (mm)									
	Feinkörniges Hartmetall	Beschichtet		Metr. Gewinde		Gewindeform UN		DMIN	RE	DCON	LF	LU	CDX	WF	PDX	WF2	H
				Gewinde	Steigung (mm)	Gewinde	Steigung (Gang/Zoll)										
	TF15	VP15TF															
CT0305RS-M4	★	★	Ohne	≥ M4	0.5–1.0			3	0.03	3	50	5.2	6	1.3	0.6	1.2	2.7
CT03RS-M4	●	●	Ohne	≥ M4	0.5–1.0	≥ NO.8-32UNC		3	0.03	3	50	10.2	6	1.3	0.6	1.2	2.7
CT03RS-M4B	●	●	Mit	≥ M4	0.5–1.0	≥ NO.8-36UNF		3	0.03	3	50	10.2	6	1.3	0.6	1.2	2.7
CT0407RS-M6	★	★	Ohne	≥ M6	0.75–1.25			4.5	0.05	4	60	7.6	7	1.8	0.8	1.7	3.6
CT04RS-M6	●	●	Ohne	≥ M6	0.75–1.25	≥ 1/4-20UNC		4.5	0.05	4	60	15.6	7	1.8	0.8	1.7	3.6
CT04RS-M6B	●	●	Mit	≥ M6	0.75–1.25	≥ 1/4-28UNF		4.5	0.05	4	60	15.6	7	1.8	0.8	1.7	3.6
CT0511RS-M8	★	★	Ohne	≥ M8	0.75–1.5			6	0.05	5	70	11	8	2.3	1	2.2	4.5
CT05RS-M8	●	●	Ohne	≥ M8	0.75–1.5	≥ 5/16-18UNC		6	0.05	5	70	21	8	2.3	1	2.2	4.5
CT05RS-M8B	●	●	Mit	≥ M8	0.75–1.5	≥ 5/16-24UNF		6	0.05	5	70	21	8	2.3	1	2.2	4.5
CT0611RS-M10	★	★	Ohne	≥ M10	0.75–1.75			7	0.05	6	75	11	8	2.8	1	2.2	5.4
CT06RS-M10	●	●	Ohne	≥ M10	0.75–1.75	≥ 3/8-16UNC		7	0.05	6	75	21	8	2.8	1	2.2	5.4
CT06RS-M10B	●	●	Mit	≥ M10	0.75–1.75	≥ 3/8-24UNF		7	0.05	6	75	21	8	2.8	1	2.2	5.4

## SCHNITTDATENEMPFEHLUNGEN

	Material	Schnittgeschw. (m/min)	Empfohlene Auskräglänge (mm)
P	C-Stahl Leg. Stahl	50 (30–80)	
M	Rostfreier Stahl	50 (30–80)	
K	Guss	50 (30–80)	
N	Nichteisenmetalle	80 (50–100)	

Hinweis 1) Einsatz von Kühlschmierstoff wird empfohlen.  
Hinweis 2) Weil bei kleinen Durchmesser die Schnittgeschwindigkeit nicht erreicht werden kann, achten Sie darauf, dass der Vorschub entsprechend zurückgenommen wird.

## STANDARD SCHNITTITIEFE

● Die rechte Tabelle zeigt die empfohlenen Schnitttiefen für metr. Aussengewinde (ISO).

## Metrisch

		(mm)					
P(Steigung)		0.50	0.75	1.00	1.25	1.50	1.75
Gesamt Schnitttiefe		0.29	0.43	0.58	0.72	0.87	1.01
Anzahl der Durchgänge	1	0.06	0.06	0.07	0.07	0.07	0.07
	2	0.05	0.06	0.06	0.07	0.07	0.07
	3	0.05	0.05	0.06	0.07	0.07	0.07
	4	0.04	0.05	0.05	0.07	0.07	0.07
	5	0.03	0.04	0.05	0.06	0.06	0.07
	6	0.03	0.04	0.05	0.06	0.06	0.06
	7	0.02	0.04	0.04	0.05	0.06	0.06
	8	0.01	0.03	0.04	0.05	0.06	0.06
	9	–	0.03	0.04	0.05	0.05	0.06
	10	–	0.02	0.03	0.04	0.05	0.05
	11	–	0.01	0.03	0.04	0.05	0.05
	12	–	–	0.03	0.03	0.04	0.05
	13	–	–	0.02	0.03	0.04	0.04
	14	–	–	0.01	0.02	0.03	0.04
	15	–	–	–	0.01	0.03	0.04
	16	–	–	–	–	0.03	0.03
	17	–	–	–	–	0.02	0.03
	18	–	–	–	–	0.01	0.03
	19	–	–	–	–	–	0.03
	20	–	–	–	–	–	0.02
	21	–	–	–	–	–	0.01

● : Lagerstandard. ★ : Lagerstandard in Japan.  
(MICRO-MINI TWIN: in einer Packung mit 1 Stück erhältlich.)

ERSATZTEILE > N001  
TECHNISCHE DATEN > P001

G031

G

GEWINDE DREHEN

## ■ HINWEISE FÜR DEN EINSATZ VON MICRO-MINI BOHRSTANGEN

● Einsatz des Halters bei allgemeiner Bearbeitung / kleine Drehautomaten:

1 Setzen Sie die Bohrstange vorsichtig in den Halter ein, um einen Bruch der zweiten Schneidkante zu vermeiden!

Zu Bild 1: Bei Kontakt der Bohrstange mit der Innenfläche des Halters kann es zu Ausbrüchen kommen.

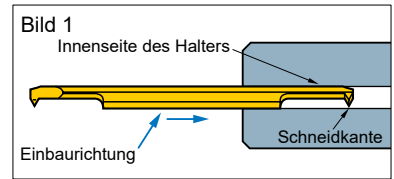

2 Beim Spannen der Bohrstange im Halter, kann es zu Beschädigungen der Bohrstange bzw. der zweiten Schneidkante kommen. Spannen Sie die Schrauben mit dem vorgegebenen Anziehmoment. Achten Sie darauf, dass keine Spannschraube nahe der zweiten Schneidkante ist, da diese brechen könnte.

3 Beim Einsatz des Mitsubishi Halters und einer Auskrägung von 5xD entfernen Sie bitte die 3. Spannschraube. (Bei RBH1620N, RBH1920N gibt es keine 3. Spannschraube). Das Anziehmoment für diese Schrauben ist 2.0N•m.

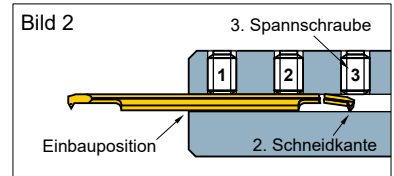

● Beim Einsatz des Vierkanthalters :

1 Beim Einbau der Bohrstange in den Halter achten Sie darauf, dass die MICRO-MINI Bohrstange an der Referenzfläche anliegt.

2 Versichern Sie sich, dass die Spannschrauben gespannt sind. Die empfohlenen Anziehmomente sind in der Tabelle der Standard Bohrstange zu finden (G029). Ziehen Sie die Spannschrauben richtig an, andernfalls kann eine feste Spannung nicht garantiert werden.

3 Spannen Sie die Spannschraube nicht ohne Bohrstange, andernfalls kann es zur Verformung der Spannbrücke kommen.

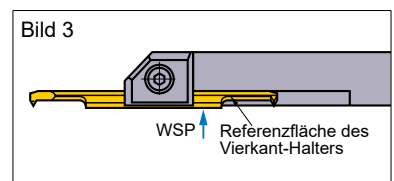

## VIERKANT AUSFÜHRUNG

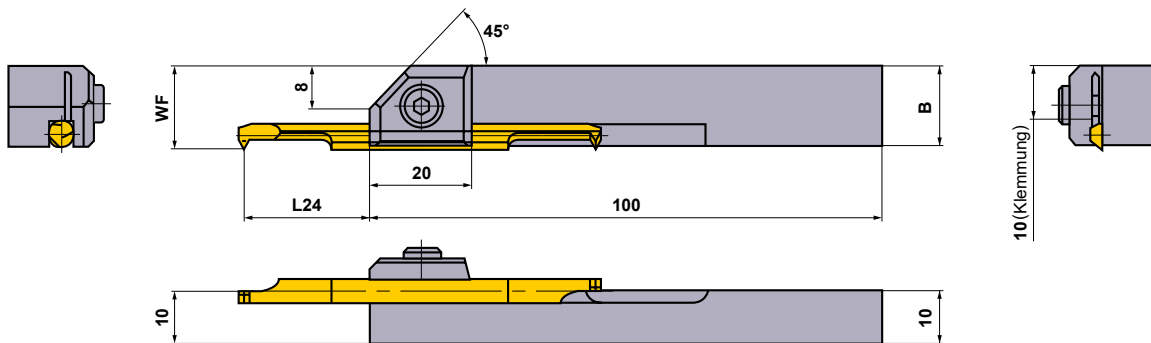

Bestellbezeichnung	Lager	Abmessungen (mm)			Micro-Mini Twin CT	Spannschraube	Schlüssel	Drehmoment (N•m)
		Micro-Mini Twin CT						
		B	WF	L24 *				
SBH1030R	★	13.8	13.8	13–17.5(14)	0305RS-M4, 03RS-M4(B)	HSC05012	HKY40R	9.5
SBH1040R	★	14.7	14.8	18.5–22(19.5)	0407RS-M6, 04RS-M6(B)	HSC05012	HKY40R	9.5
SBH1050R	★	15.6	15.8	24–26.5(25)	0511RS-M8, 05RS-M8(B)	HSC05012	HKY40R	9.5
SBH1060R	★	16.5	16.8	24–31.5(25)	0611RS-M10, 06RS-M10(B)	HSC05012	HKY40R	9.5

\* L24 ist die Länge der Auskrägung für eine ausreichende Befestigung, und ( ) ist die empfohlene Länge für die Bearbeitung von Kohlenstoff- und Legierungsstahl.

# RUNDE AUSFÜHRUNG

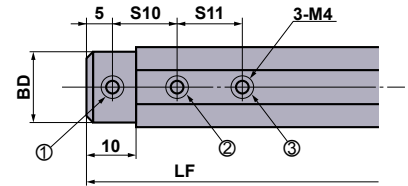
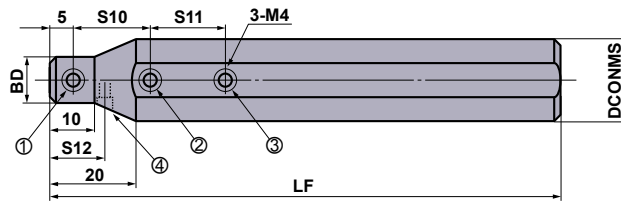
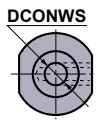

RBH15800N, RBH1600N,  
RBH19000N

RBH2200N verfügt über eine Stellschraube zum behelfsmäßigen Einsatz für unterschiedliche Maschinenspezifikationen. (Abbildung siehe Nummer 4)

Bestellbezeichnung	Lager	Abmessungen (mm)						Micro-Mini Twin CT	*1 Spannschraube				Schlüssel	Drehmoment (N·m)	
		DCONMS	DCONWS	BD	LF	S10	S11		S12	①	②	③			④
RBH15830N	★	15.875	3	15	100	10	10	—	0305RS-M4, 03RS-M4(B)	A	A	A	—	HKY20F	2.0
RBH15840N	★	15.875	4	15	100	15	15	—	0407RS-M6, 04RS-M6(B)	A	A	A	—	HKY20F	2.0
RBH15850N	★	15.875	5	15	100	15	15	—	0511RS-M8, 05RS-M8(B)	A	A	A	—	HKY20F	2.0
RBH15860N	★	15.875	6	15	100	15	15	—	0611RS-M10, 06RS-M10(B)	A	A	A	—	HKY20F	2.0
RBH1630N	●	16	3	15	100	10	10	—	0305RS-M4, 03RS-M4(B)	A	A	A	—	HKY20F	2.0
RBH1640N	●	16	4	15	100	15	15	—	0407RS-M6, 04RS-M6(B)	A	A	A	—	HKY20F	2.0
RBH1650N	●	16	5	15	100	15	15	—	0511RS-M8, 05RS-M8(B)	A	A	A	—	HKY20F	2.0
RBH1660N	●	16	6	15	100	15	15	—	0611RS-M10, 06RS-M10(B)	A	A	A	—	HKY20F	2.0
*2 RBH19030N	★	19.05	3	18	125	10	10	—	0305RS-M4, 03RS-M4(B)	B	B	B	—	HKY20F	2.0
*2 RBH19040N	★	19.05	4	18	125	15	15	—	0407RS-M6, 04RS-M6(B)	B	B	B	—	HKY20F	2.0
*2 RBH19050N	★	19.05	5	18	125	15	15	—	0511RS-M8, 05RS-M8(B)	B	B	B	—	HKY20F	2.0
*2 RBH19060N	★	19.05	6	18	125	15	15	—	0611RS-M10, 06RS-M10(B)	B	B	B	—	HKY20F	2.0
RBH2030N	★	20	3	12	125	10	10	—	0305RS-M4, 03RS-M4(B)	A	A	B	—	HKY20F	2.0
RBH2040N	★	20	4	13	125	15	15	—	0407RS-M6, 04RS-M6(B)	A	B	B	—	HKY20F	2.0
RBH2050N	★	20	5	14	125	15	15	—	0511RS-M8, 05RS-M8(B)	A	B	B	—	HKY20F	2.0
RBH2060N	★	20	6	15	125	15	15	—	0611RS-M10, 06RS-M10(B)	A	B	B	—	HKY20F	2.0
RBH2230N	★	22	3	12	125	10	10	10	0305RS-M4, 03RS-M4(B)	A	B	C	A	HKY20F	2.0
RBH2240N	★	22	4	13	125	15	15	12.5	0407RS-M6, 04RS-M6(B)	A	B	B	A	HKY20F	2.0
RBH2250N	★	22	5	14	125	15	15	12.5	0511RS-M8, 05RS-M8(B)	A	B	B	A	HKY20F	2.0
RBH2260N	★	22	6	15	125	15	15	15	0611RS-M10, 06RS-M10(B)	A	B	B	A	HKY20F	2.0
RBH2530N	★	25	3	12	150	10	10	—	0305RS-M4, 03RS-M4(B)	A	B	C	—	HKY20F	2.0
RBH2540N	★	25	4	13	150	15	15	—	0407RS-M6, 04RS-M6(B)	A	C	C	—	HKY20F	2.0
RBH2550N	★	25	5	14	150	15	15	—	0511RS-M8, 05RS-M8(B)	A	C	C	—	HKY20F	2.0
RBH2560N	★	25	6	15	150	15	15	—	0611RS-M10, 06RS-M10(B)	A	C	C	—	HKY20F	2.0
RBH25430N	★	25.4	3	12	150	10	10	—	0305RS-M4, 03RS-M4(B)	A	B	C	—	HKY20F	2.0
RBH25440N	★	25.4	4	13	150	15	15	—	0407RS-M6, 04RS-M6(B)	A	C	C	—	HKY20F	2.0
RBH25450N	★	25.4	5	14	150	15	15	—	0511RS-M8, 05RS-M8(B)	A	C	C	—	HKY20F	2.0
RBH25460N	★	25.4	6	15	150	15	15	—	0611RS-M10, 06RS-M10(B)	A	C	C	—	HKY20F	2.0

\*1 Bestellnummer der Klemmschraube A=HSS04004, B=HSS04006, C=HSS04008

\*2 Neue Bestellbezeichnung.

Alte Bestellbezeichnung	Neue Bestellbezeichnung
RBH1930N	RBH19030N
RBH1940N	RBH19040N
RBH1950N	RBH19050N
RBH1960N	RBH19060N

● : Lagerstandard. ★ : Lagerstandard in Japan.

ERSATZTEILE > N001  
TECHNISCHE DATEN > P001

# Notizen

---

A series of horizontal dashed lines for writing notes, spanning the width of the page.

# Notizen

---

A series of horizontal dashed lines for writing notes, spanning the width of the page.

# ALLGEMEINE ERKLÄRUNG: HSK-T WERKZEUGE

● Wie sind die Seiten dieses Kapitels aufgebaut

① Aufgelistet nach Produktserien.  
(Beachten Sie das Inhaltsverzeichnis auf der nächsten Seite.)

## PRODUKTBEZEICHNUNG

Die ersten vier Buchstaben der Bestellbezeichnung, sowie der Anwendungsbereich werden aufgelistet.

## SERIENBEZEICHNUNG

## PRODUKT KAPITEL

### HSK-T WERKZEUGE

## HSK-T SYSTEM

### PCLN

**Außerdrehen • Pfandrehen**

Schlichten	Leicht	Mittel
FP (12)	LF (12)	LP (12)
Mittel	Mittel	Schneppen
Mik	Standard	Standard
RP (12)	RP (12)	RP (12)
Rosfrei	PCBN	PCBN
Mik	Mik	Mik

Abb. zeigt Rechtausführung

Bestellbezeichnung	WSP Bezeichnung	Abmessungen (mm)	#1	#2	WSP	WSP	WSP	WSP	WSP	WSP	WSP	WSP
H63TH-PCLNRL-DX12	CN/G CN/G CN/M	1204/20	63	65	45	1.3	LLSCN42	LLP14	LLCL14	LLCS108	HKY30R	

\*1 Spannmoment (N·m): LLCS108=3  
\*2 WT: Werkzeuggewicht  
Hinweis 1) Abmaße beziehen sich auf Wendeschneidplatten mit Eckenradius 0,8mm.

### DCLN

**Außerdrehen • DOPPELKLEMM Ausführung**

Schlichten	Leicht	Mittel
FP (12)	LF (12)	LP (12)
Mittel	Mittel	Schneppen
Mik	Standard	Standard
RP (12)	RP (12)	RP (12)
Rosfrei	PCBN	PCBN
Mik	Mik	Mik

Abb. zeigt Rechtausführung

Bestellbezeichnung	WSP Bezeichnung	Abmessungen (mm)	#1	#2	WSP	WSP	WSP	WSP	WSP	WSP	WSP	WSP
H63TH-DCLNRL-DX12	CN/G CN/G CN/M	1204/20	63	65	45	1.3	LLSCN42	LLP14	DOCK213	DCS1	DC0621T	TKY20F

\*1 Spannmoment (N·m): DC0621T=5,0  
\*2 WT: Werkzeuggewicht  
Hinweis 1) Abmaße beziehen sich auf Wendeschneidplatten mit Eckenradius 0,8mm.

ABBILDUNG ZEIGT ANWENDUNGSBEREICH  
Zeichnungen zeigen den Anwendungsbereich durch Pfeile und Winkel.

## ABBILDUNG SPANBRECHER ÜBERSICHT

**PCMN**

**Außerdrehen • Pfandrehen**

Schlichten	Leicht	Mittel
FP (12)	LF (12)	LP (12)
Mittel	Mittel	Schneppen
Mik	Standard	Standard
RP (12)	RP (12)	RP (12)
Rosfrei	PCBN	PCBN
Mik	Mik	Mik

Bestellbezeichnung	WSP Bezeichnung	Abmessungen (mm)	#1	#2	WSP	WSP	WSP	WSP	WSP	WSP	WSP	WSP
H63TH-PCMN-H12	CN/G CN/G CN/M	1204/20	63	100	1,7	LLSCN42	LLP14	LLCL14	LLCS108	HGM-P118	HKY30R	
H63TH-PCMNN-L12	CN/G CN/G CN/M	1204/20	63	140	2,7	LLSCN42	LLP14	LLCL14	LLCS108	HGM-P118	HKY30R	

\*1 Spannmoment (N·m): LLCS108=3,3  
\*2 WT: Werkzeuggewicht  
Hinweis 1) Abmaße beziehen sich auf Wendeschneidplatten mit Eckenradius 0,8mm.

**DCMN**

**Außerdrehen • DOPPELKLEMM Ausführung**

Schlichten	Leicht	Mittel
FP (12)	LF (12)	LP (12)
Mittel	Mittel	Schneppen
Mik	Standard	Standard
RP (12)	RP (12)	RP (12)
Rosfrei	PCBN	PCBN
Mik	Mik	Mik

Bestellbezeichnung	WSP Bezeichnung	Abmessungen (mm)	#1	#2	WSP	WSP	WSP	WSP	WSP	WSP	WSP	WSP
H63TH-DCMN-H12	CN/G CN/G CN/M	1204/20	63	100	1,7	LLSCN42	LLP14	DOCK213	DCS1	DC0621T	TKY20F	
H63TH-DCMNN-L12	CN/G CN/G CN/M	1204/20	63	140	2,7	LLSCN42	LLP14	DOCK213	DCS1	DC0621T	TKY20F	

\*1 Spannmoment (N·m): DC0621T=5,0  
\*2 WT: Werkzeuggewicht  
Hinweis 1) Abmaße beziehen sich auf Wendeschneidplatten mit Eckenradius 0,8mm.

### H006

● Lagerstandard.  
**LEGENDE FÜR LAGERSYMBOL**  
Wird auf jeder Doppelseite auf der linken Seite gezeigt.

**STANDARDPRODUKTE**  
Beinhaltet Bestellbezeichnung, Lagerstatus, rechte/linke WSP, Abmessungen, Ersatzteile, min. Bearbeitungsdurchm., Eckenradius, empfohlene Auskrantung und Einsatzart.

**QUERVERWEISE VERFUGBARE WSP**  
Weist auf weitere detaillierte Produktinformationen der verschiedenen WSP-Ausführungen hin.

**QUERVERWEIS AUF ANDERE SEITEN**  
-ERSATZTEILE  
-TECHNISCHE DATEN  
Beinhaltet Querverweise für alle auf dieser Doppelseite aufgeführten Produkte.

● Bei Bestellung: Bitte Bestellbezeichnung und Werkzeugausführung angeben (rechts/links)



# HSK-T WERKZEUGE

ÜBERSICHT DER HSK-T-WERKZEUGE .....	H002
KLASSIFIKATION DER HSK-T WERKZEUGE .....	H004
<b>STANDARD HSK-T-WERKZEUGE</b>	
<b>AUSSENDREHEN • PLANDREHEN</b>	
CN○○WSP DREHHALTER .....	H006
DN○○WSP DREHHALTER .....	H011
<b>AUSSENDREHEN • PLANDREHEN • AUSDREHEN</b>	
CN○○WSP DREHHALTER .....	H008
<b>AUSSENDREHEN • KOPIEREN</b>	
DN○○WSP DREHHALTER .....	H009
<b>AUSSENDREHEN • PLANDREHEN • KOPIEREN</b>	
RC○○WSP DREHHALTER .....	H012
<b>PLANDREHEN • KOPIEREN</b>	
VB○○WSP DREHHALTER .....	H013
<b>STECHEN</b>	
MG WSP DREHHALTER .....	H014
<b>GEWINDEDREHEN</b>	
MMT WSP DREHHALTER .....	H016
MT WSP DREHHALTER .....	H017
WERKZEUGHALTER DREHEN .....	H019
WERKZEUGHALTER STECHEN .....	H021
HÜLSEN FÜR BOHRSTANGEN .....	H022

## \*Alphabetisches Inhaltsverzeichnis

H022	H100TH-B○○○○○	H014	H63TH-MGHR/L-DX43○○
H020	H100TH-EN3232R/L-130	H016	H63TH-MMTER-H/L16
H019	H100TH-EV3232R/L-180	H016	H63TH-MMTER-DX16
H008	H63TH-A○○○○DCLNR/L12	H017	H63TH-MTHR/L-DX43
H021	H63TH-B○○○○○	H006	H63TH-PCLNR/L-DX12
H008	H63TH-DCLNL-L12-3	H007	H63TH-PCMNN-H/L12
H006	H63TH-DCLNR/L-DX12	H009	H63TH-PDJNR/L-DX15
H007	H63TH-DCMNN-H/L12	H010	H63TH-PDNNN-H/L15
H011	H63TH-DDJNL-L15-3	H012	H63TH-PRDCN-H/L12
H009	H63TH-DDJNR/L-DX15	H012	H63TH-PRGCR/L-DX12
H010	H63TH-DDNNN-H/L15	H013	H63TH-SVPBR/L-DX16
H020	H63TH-EN2525R/L-115	H013	H63TH-SVVBH-H/L16
H021	H63TH-EV2020R/L-105-3	H022	SL32○○-90
H019	H63TH-EV2525R/L-112		



Werkzeugsystem  
für das Drehen auf  
Multi-Task-Maschinen

# HSK WERKZEUGE

## HSK-T System

Das HSK-T ist eine neues HSK-System, das für das Drehen auf Multi-Task-Maschinen vorgesehen ist, die mit dem HSK-A-Typ kompatibel sind (ISO-Norm: ISO12164-1:2001). Das HSK-System wurde von einem Konsortium aus 17 japanischen Herstellern entwickelt und 2008 im ISO-Standard (ISO12164-3:2008) unter dem Namen HSK-T Typ und 2013 im JIS-Standard (JIS B6064-3) registriert.



## Hochexakte Positionierung der Schneidkante

Der HSK-T-Typ weist eine engere Toleranz zwischen dem Mitnehmer der Spindel und der Mitnehmernut des Werkzeughalters auf als der HSK-A-Typ. Dies führt zu einer höheren Positionsgenauigkeit der Schneidkante. Beim Drehen können weiterhin Werkzeuge des konventionellen HSK-A-Typs zum Einsatz kommen.

## Für Multi-Task-Maschinen und Bearbeitungszentren geeignet

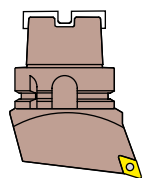

HSK-T  
Drehwerkzeughalter

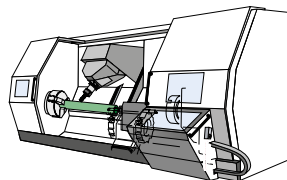

HSK-T-Spindel  
Multi-Task-Maschinen

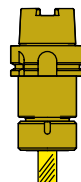

HSK-A  
Werkzeugdrehhalter

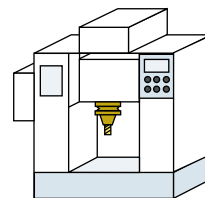

HSK-A-Spindel  
Bearbeitungszentrum

H

HSK-T WERKZEUGE

### \*Hinweis

Kurze stabile Auskraglänge des HSK-T-Drehwerkzeugs wie in der Abbildung oben gezeigt.

Bitte vor dem Einsatz überprüfen, da einige Aufnahmen je nach ATC-Vorgaben der Multi-Task-Maschine (HSK-A Typ) nicht montiert werden können.

Bitte beachten Sie die Kollisionsgefahr im Magazin mit Nachbarwerkzeugen.

Hinterschliff  
HSK-T63 Min.4mm  
HSK-T100 Min.5mm

Aussenmaß  
HSK-T63 Max.62mm  
HSK-T100 Max.99mm

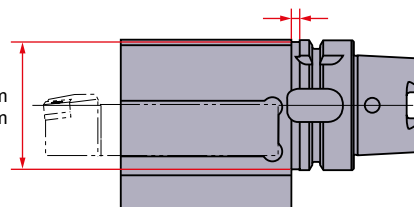

Standard HSK-T-Drehwerkzeug (Beispiel)

## Verbesserte Toleranz der Mitnehmernut

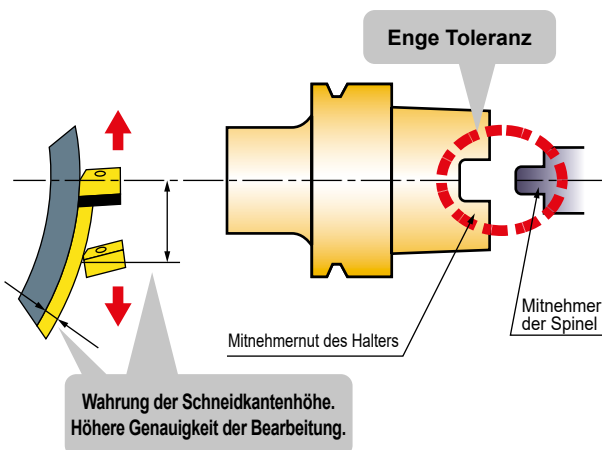

### Toleranzvergleich (Beispiel) (mm)

System	Dimension 1 (mm)	Dimension 2 (mm)	Dimension 3 (mm)	Dimension 4 (mm)	Dimension 5 (mm)	Dimension 6 (mm)
HSK A63	12.25	12.35	0.10 (Toleranz Mitnehmernut)	0.15 (Minimaler Abstand)	0.08	12.58 (Toleranz der Mitnehmernut)
	0.33 Maximales Spiel					
	12.5 (Toleranz der Mitnehmernut)					
	0.08 (Toleranz der Mitnehmernut)					
HSK T63	12.385	12.41	0.025	0.015 (Minimaler Abstand)	0.035	12.46 (Toleranz der Mitnehmernut)
	0.075 Maximales Spiel					
	12.425 (Toleranz der Mitnehmernut)					
	0.035 (Toleranz der Mitnehmernut)					

# Hochexaktes und hochsteifes HSK-T-Werkzeugsystem, entwickelt für den Einsatz auf Multi-Task-Maschinen.

## Neutrale Werkzeuge, die sich für den Einsatz an Multi-Task-Maschinen eignen.

Verhindert Werkzeugkollisionen durch verbesserte Werkzeugzugänglichkeit.

Durch Neigen der B-Spindel der Maschinen (Hauptachse des Werkzeugs) um 45 Grad lässt sich eine Beeinträchtigung zwischen Spindel, Halter, Werkstück und Spannvorrichtung verhindern.

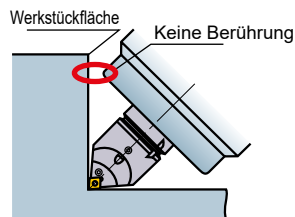

Verbesserte Schneidkantenposition durch Zentrierung in der Mitte der Spindel.

Hohe Steifigkeit und Positioniergenauigkeit lassen sich so erreichen, da die Mittellinienhöhe der Schneidkante nicht durch den Abstand zwischen Mitnehmer und Nut beeinträchtigt wird.

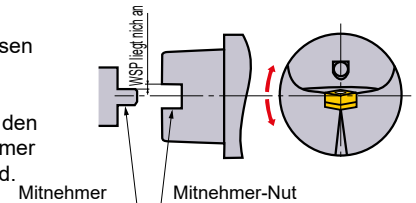

## Neue HSK-T Aufnahmen mit Doppelklemmung der WSP

Die Doppelklemmung bietet hohe Steifigkeit, Genauigkeit und Zuverlässigkeit, sodass eine sichere Klemmung gewährleistet wird. Ideal für schwer zu bearbeitende Materialien, wie rostfreie Stähle und wärmebeständige Legierungen.



Links-/Rechtsausführung, zum Drehen und Plandrehen

Gerade Ausführung, zum Drehen und Plandrehen

Zum Drehen, Plandrehen und Bohren

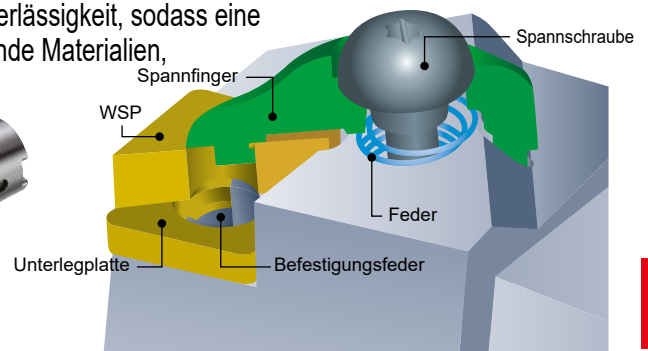

## Multi-Task HSK-T 3-in-1 Werkzeuge

3 WSP derselben Größe lassen sich an einem einzelnen Werkzeug einsetzen.

Mehrfach-Bestückung für schnellen Wechsel bei Verschleiß. Ideal für unterschiedliche Bearbeitungsprozesse sowie unterschiedliche Werkstoffe.

Unterschiedliche WSP-Spanbrecher können für verschiedene Anwendungen verwendet werden (Schruppen, Vorschlichten und Schlichten).

Es können auch unterschiedliche Sorten verwendet werden.



## Neue HSK-T100-Größe für große Werkstücke

Größere Werkzeugaufnahmen für hocheffiziente Bearbeitungen.

Rechteckige Werkzeugaufnahme



Bohrstange / Ausführung



Hülse







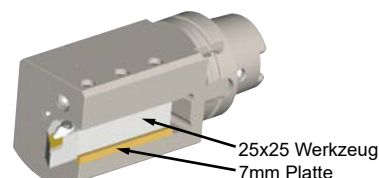





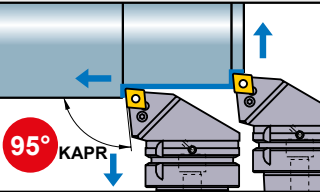

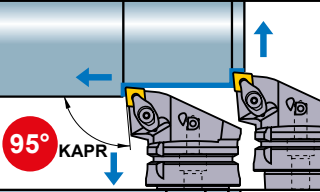

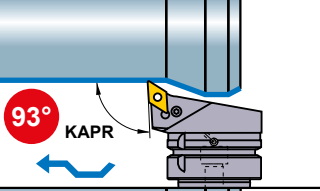
Die Aufnahme kann mit Werkzeughaltern unterschiedlicher Größen verwendet werden.

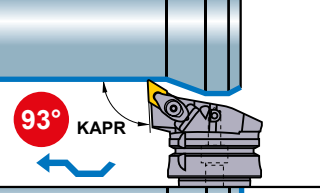

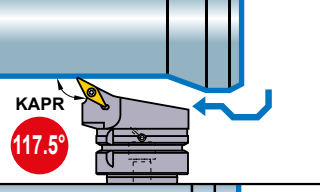

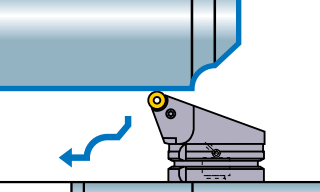

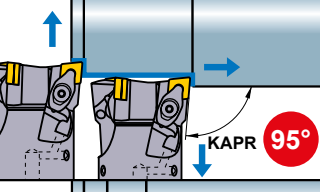

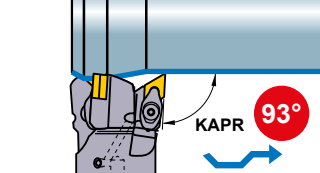

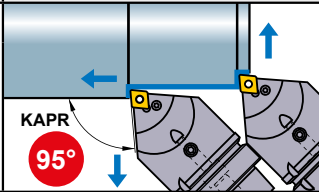
- Lieferbar für die Verwendung mit JIS B4126 (ISO 5610) 32x32 und 32x25 Werkzeughaltern.
- Geeignet für 25x25 Werkzeug bei Verwendung einer 7mm Platte.
- \*Platte nicht im Lieferumfang enthalten.

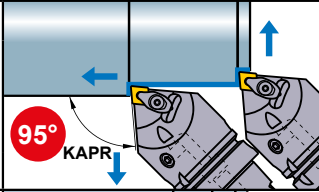

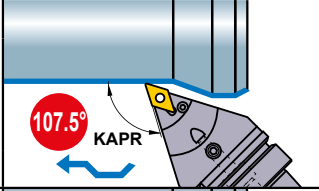
# KLASSIFIKATION DER HSK-T WERKZEUGE

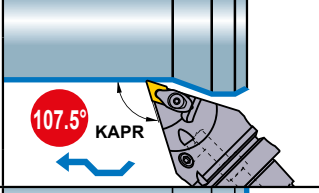
## AUSSENDREHEN • PLANDREHEN • KOPIEREN

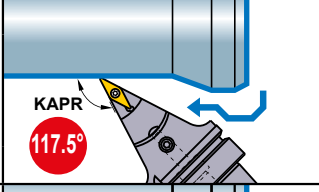

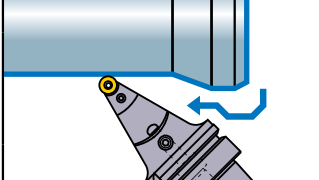
Bestellbezeichnung	Abbildung
H63TH-PCLNR/L-DX12  ↻ H006	 95° KAPR
H63TH-DCLNR/L-DX12  ↻ H006	 95° KAPR
H63TH-PDJNR/L-DX15  ↻ H009	 93° KAPR
H63TH-DDJNR/L-DX15  ↻ H009	 93° KAPR
H63TH-SVPBR/L-DX16  ↻ H013	 KAPR 117.5°
H63TH-PRGCR/L-DX12  ↻ H012	 KAPR
H63TH-DCLNL-L12-3  ↻ H008	 KAPR 95°
H63TH-DDJNL-L15-3  ↻ H011	 KAPR 93°

Bestellbezeichnung	Abbildung
H63TH-PCMNN-H/L12  ↻ H007	 KAPR 95°
H63TH-DCMNN-H/L12  ↻ H007	 KAPR 95°
H63TH-PDNNN-H/L15  ↻ H010	 KAPR 107.5°
H63TH-DDNNN-H/L15  ↻ H010	 KAPR 107.5°
H63TH-SVVBH-H/L16  ↻ H013	 KAPR 117.5°
H63TH-PRDCN-H/L12  ↻ H012	 KAPR

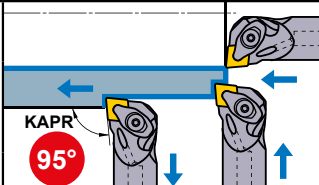



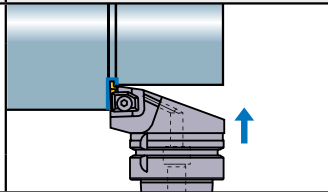



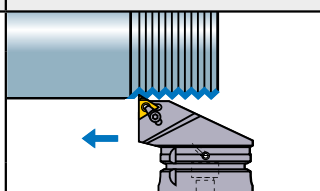

## AUSSENDREHEN • PLANDREHEN • AUSDREHEN

Bestellbezeichnung	Abbildung
H63TH-A25KDCLNR/L12 H63TH-A32LDCLNR/L12  ↻ H008	 KAPR 95°

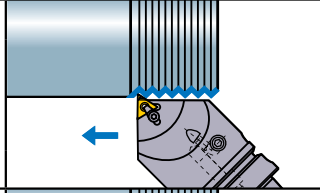



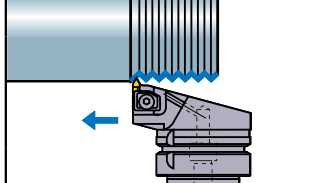









## EIN- UND ABSTECHEN

Bestellbezeichnung	Abbildung
H63TH-MGHR/L-DX43 	
  H014	

















## GEWINDEDREHEN

Bestellbezeichnung	Abbildung
H63TH-MMTER-DX16 	
  H016	
H63TH-MMTENR-H/L16 	
  H016	
H63TH-MTHR/L-DX43 	
  H017	

## WERKZEUGHALTER DREHEN

Bestellbezeichnung	Halter
H63TH-EV2525R/L-112 	
 H019	
H100TH-EV3232R/L-180 	
 H019	
H63TH-EN2525R/L-115 	
*1  H020	
H100TH-EN3232R/L-130 	
*1  H020	
H63TH-EV2020R/L-105-3 	
 H021	

## BOHRSTANGEN

Bestellbezeichnung	Halter
H63TH-B    	
 H021	
H100TH-B    	
 H022	
SL32   -90 (Hülse)	
*2  H022	

Hinweis 1) Die HSK63A Schaftausführung hat eine vorinstallierte Kühlmittelübergabe.

\*1 Mitsubishi Materials produziert und vertreibt diese Werkzeuge unter einer Lizenz der MORI SEIKI CO., LTD unter dem Patent Nr. 3720202.

\*2 Die SL32  -90-Hülse eignet sich nur für den Einsatz mit H100TH-B32-135.



# HSK-T SYSTEM

## PCLN

### Außendrehen • Plandrehen











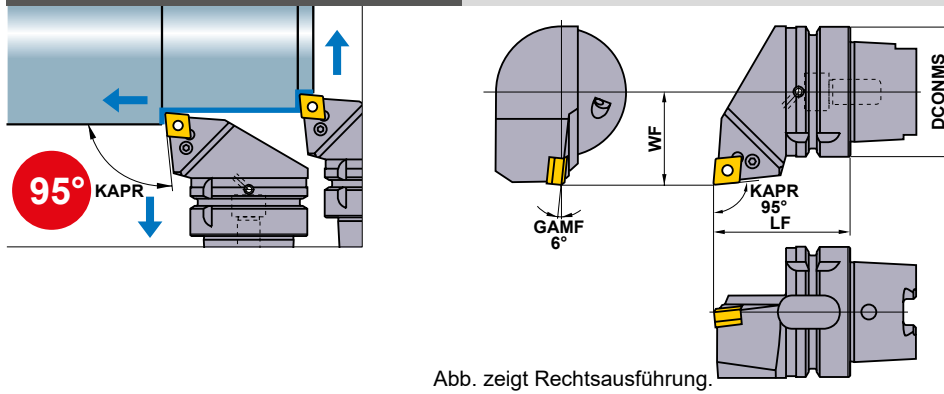





Abb. zeigt Rechtsausführung.

Schichten	Leicht	Mittel
FP  (12)	LP  (12)	MP  (12)
Mittel MK  (12)	Mittel Standard  (12)	Mittel-Schruppen RP  (12)
Rostfrei MM  (12)	PCBN  (12)	

Bestellbezeichnung	Lager		WSP Bezeichnung	Abmessungen (mm)			*2 WT (kg)				 *1		
	R	L		DCONMS	LF	WF		Unterlegplatte	Befestigungsfeder	Kniehebel	Spannschraube	Schlüssel	
<b>H63TH-PCLNR/L-DX12</b>	●	●	CN◊A CN◊G CN◊M	1204	63	65	45	1.3	LLSCN42	LLP14	LLCL14	LLCS108	HKY30R

\*1 Spannmoment (N • m) : LLCS108=3.3

\*2 WT : Werkzeuggewicht

Hinweis 1) Abmaße beziehen sich auf Wendeschneidplatten mit Eckenradius 0,8mm.

## DCLN

### Außendrehen • Plandrehen DOPPELKLEMM Ausführung











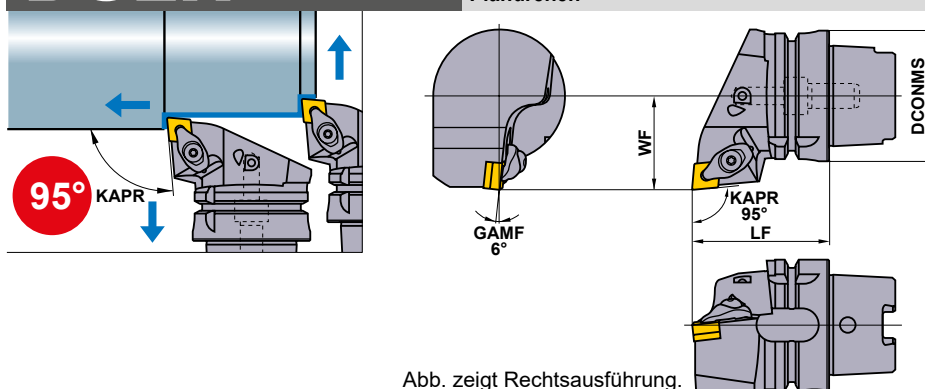





Abb. zeigt Rechtsausführung.

Schichten	Leicht	Mittel
FP  (12)	LP  (12)	MP  (12)
Mittel MK  (12)	Mittel Standard  (12)	Mittel-Schruppen RP  (12)
Rostfrei MM  (12)	PCBN  (12)	

Bestellbezeichnung	Lager		WSP Bezeichnung	Abmessungen (mm)			*2 WT (kg)					 *1		
	R	L		DCONMS	LF	WF		Unterlegplatte	Befestigungsfeder	Spannfinger	Feder	Spannschraube	Schlüssel	
<b>H63TH-DCLNR/L-DX12</b>	●	●	CN◊A CN◊G CN◊M	1204	63	65	45	1.3	LLSCN42	LLP14	DCK2613	DCS1	DC0621T	TKY20F

\*1 Spannmoment (N • m) : DC0621T=5.0

\*2 WT : Werkzeuggewicht

Hinweis 1) Abmaße beziehen sich auf Wendeschneidplatten mit Eckenradius 0,8mm.







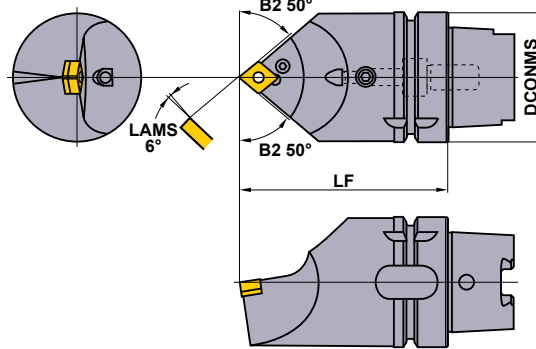
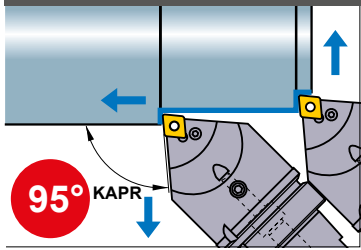

● : Lagerstandard.







PCLN WSP	> A098 – A104
DCLN WSP	> A098 – A104
PCBN & PKD WSP	> B036 – B038, B064
SCHNITTDATENEMPFEHLUNGEN	> A074

# PCMN

## Außendrehen • Plandrehen



Schichten	Leicht	Mittel
FP  (12)	LP  (12)	MP  (12)
Mittel MK  (12)	Mittel Standard  (12)	Mittel-Schruppen RP  (12)
Rostfrei MM  (12)	PCBN  (12)	

Bestellbezeichnung	Lager	WSP Bezeichnung	Abmessungen (mm)		*2 WT (kg)						
			DCONMS	LF		Unterlegplatte	Befestigungsfeder	Kniehebel	Spannschraube	Stopfen	Schlüssel
H63TH-PCMNN-H12	●	CN $\circ$ A CN $\circ$ G CN $\circ$ M	63	100	1.7	LLSCN42	LLP14	LLCL14	LLCS108	HGM-PT1/8	HKY30R
H63TH-PCMNN-L12	●		63	140	2.7	LLSCN42	LLP14	LLCL14	LLCS108	HGM-PT1/8	HKY30R

\*1 Spannmoment (N • m) : LLCS108=3.3







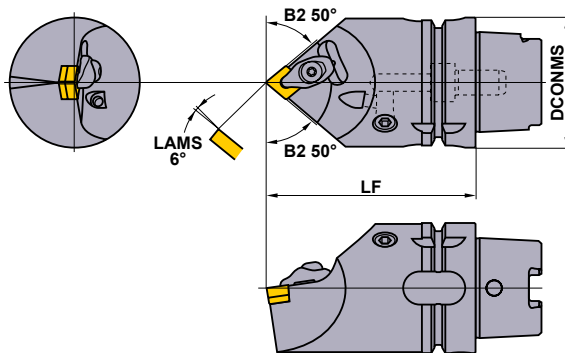
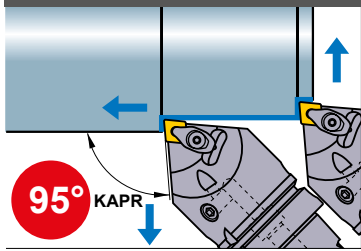

\*2 WT : Werkzeuggewicht







Hinweis 1) Abmaße beziehen sich auf Wendeschneidplatten mit Eckenradius 0,8mm.

# DCMN

## Außendrehen • Plandrehen DOPPELKLEMM Ausführung



Schichten	Leicht	Mittel
FP  (12)	LP  (12)	MP  (12)
Mittel MK  (12)	Mittel Standard  (12)	Mittel-Schruppen RP  (12)
Rostfrei MM  (12)	PCBN  (12)	

Bestellbezeichnung	Lager	WSP Bezeichnung	Abmessungen (mm)		*2 WT (kg)						
			DCONMS	LF		Unterlegplatte	Befestigungsfeder	Spannfinger	Feder	Spannschraube	Schlüssel
H63TH-DCMNN-H12	●	CN $\circ$ A CN $\circ$ G CN $\circ$ M	63	100	1.7	LLSCN42	LLP14	DCK2613	DCS1	DC0621T	TKY20F
H63TH-DCMNN-L12	●		63	140	2.7	LLSCN42	LLP14	DCK2613	DCS1	DC0621T	TKY20F

\*1 Spannmoment (N • m) : DC0621T=5.0

\*2 WT : Werkzeuggewicht

Hinweis 1) Abmaße beziehen sich auf Wendeschneidplatten mit Eckenradius 0,8mm.

PCMN WSP	> A098 – A104
DCMN WSP	> A098 – A104
PCBN & PKD WSP	> B036 – B038, B064

SCHNITTDATENEMPFEHLUNGEN	> A074
ERSATZTEILE	> N001
TECHNISCHE DATEN	> P001

H

HSK-T WERKZEUGE

H007



# HSK-T SYSTEM

**DCLN** Außendreher • Plandrehen **DOPPELKLEMM Ausführung**

Nur Linksauflührung.

Schichten	Leicht	Mittel
FP (12)	LP (12)	MP (12)
Mittel	Mittel	Mittel-Schruppen
MK (12)	Standard (12)	RP (12)
Rostfrei	PCBN	
MM (12)	(12)	

Bestellbezeichnung	Lager		WSP Bezeichnung	Abmessungen (mm)				*2 WT (kg)	Unterlegplatte	Befestigungsfeder	Spannfinger	Feder	Spannschraube *1	Schlüssel
	L	R		DCONMS	LF	WF								
<b>H63TH-DCLNL-L12-3</b>	●		CN○A CN○G CN○M	1204	63	140	30	2.2	LLSCN42	LLP14	DCK2613	DCS1	DC0621T	TKY20F

\*1 Spannmoment (N • m) : DC0621T=5.0

\*2 WT : Werkzeuggewicht

Hinweis 1) Abmaße beziehen sich auf Wendeschneidplatten mit Eckenradius 0,8mm.

**DCLN** Außendreher • Plandrehen • Ausdrehen **DOPPELKLEMM Ausführung**

Abb. zeigt Rechtsauflührung.

Schichten	Leicht	Mittel
FP (12)	LP (12)	MP (12)
Mittel	Mittel	Mittel-Schruppen
MK (12)	Standard (12)	RP (12)
Rostfrei	PCBN	
MM (12)	(12)	

Bestellbezeichnung	Lager		WSP Bezeichnung	Abmessungen (mm)							*2 WT (kg)	Unterlegplatte	Befestigungsfeder	Spannfinger	Feder	Spannschraube *1	Schlüssel
	R	L		DCONMS	LF	LU	WF	GAMF	DMIN								
<b>H63TH-A25KDCLNR/L12</b>	●	●	CN○A CN○G CN○M	1204	63	125	82	17	11°	32	1.1	LLSCP42	LLP14	DCK2613	DCS1	DC0621T	TKY20F
<b>H63TH-A32LDCLNR/L12</b>	●	●	CN○A CN○G CN○M	1204	63	140	100	22	13°	40	1.4	LLSCN42	LLP14	DCK2613	DCS1	DC0621T	TKY20F

\*1 Spannmoment (N • m) : DC0621T=5.0

\*2 WT : Werkzeuggewicht

Hinweis 1) Abmaße beziehen sich auf Wendeschneidplatten mit Eckenradius 0,8mm.

HSK-T WERKZEUGE

● : Lagerstandard.

DCLN WSP	> A098 – A104
PCBN & PKD WSP	> B036 – B038, B064
SCHNITTDATENEMPFEHLUNGEN	> A074

# PDJN

## Außendrehen • Kopieren



Abb. zeigt Rechtsausführung.

Schichten	Leicht	Mittel
FP (15)	LP (15)	MP (15)
Mittel	Mittel-Schruppen	Rostfrei
MK (15)	RP (15)	MM (15)
G-Klasse	PCBN	
R/L (15)	(15)	

Bestellbezeichnung	Lager		WSP Bezeichnung	Abmessungen (mm)			*3 WT (kg)	*2					
	R	L		DCONMS	LF	WF		Unterlegplatte	Befestigungs-feder	Kniehebel	Spann-schraube	Schlüssel	
<b>H63TH-PDJNR/L-DX15</b>	●	●	DN $\circ$ A DN $\circ$ G DN $\circ$ M DNMX	1504 $\circ$	63	65	45	1.2	LLSDN43 (LLSDN42)	LLP14	LLCL24	LLCS108	HKY30R

\*1 Spannmoment (N • m) : LLCS108=3.3

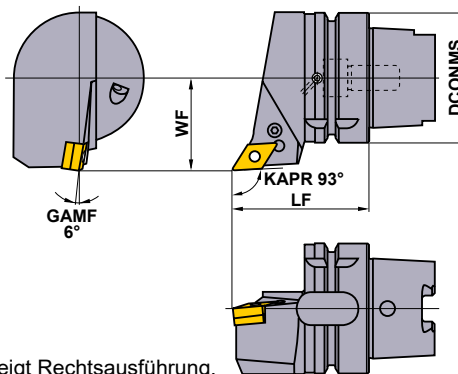
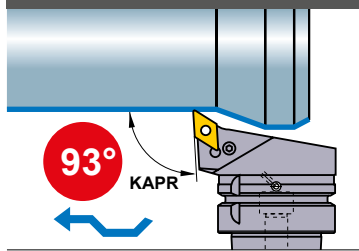
\*2 Beim Einsatz von 6.35mm dicken WSP muss die Unterlegplatte LLSDN42 verwendet werden. Die Unterlegplatte für 6.35mm dicke WSP muss separat bestellt werden.

\*3 WT : Werkzeuggewicht

Hinweis 1) Abmaße beziehen sich auf Wendeschneidplatten mit Eckenradius 0,8mm.

# DDJN

## Außendrehen • DOPPELKLEMM Ausführung



Abb. zeigt Rechtsausführung.

Schichten	Leicht	Mittel
FP (15)	LP (15)	MP (15)
Mittel	Mittel-Schruppen	Rostfrei
MK (15)	RP (15)	MM (15)
G-Klasse	PCBN	
R/L (15)	(15)	

Bestellbezeichnung	Lager		WSP Bezeichnung	Abmessungen (mm)			*3 WT (kg)	*2						
	R	L		DCONMS	LF	WF		Unterlegplatte	Befestigungs-feder	Spann-finger	Feder	Spann-schraube	Schlüssel	
<b>H63TH-DDJNR/L-DX15</b>	●	●	DN $\circ$ A DN $\circ$ G DN $\circ$ M DNMX	1504 $\circ$	63	65	45	1.2	LLSDN43 (LLSDN42)	LLP24	DCK2613	DCS1	DC0621T	TKY20F

\*1 Spannmoment (N • m) : DC0621T=5.0

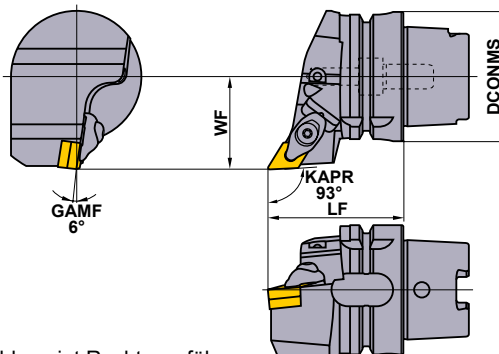
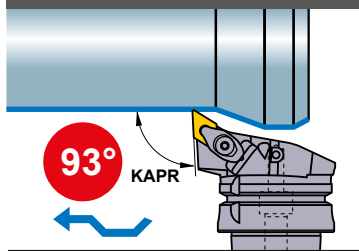
\*2 Beim Einsatz von 6.35mm dicken WSP muss die Unterlegplatte LLSDN42 verwendet werden. Die Unterlegplatte für 6.35mm dicke WSP muss separat bestellt werden.

\*3 WT : Werkzeuggewicht

Hinweis 1) Abmaße beziehen sich auf Wendeschneidplatten mit Eckenradius 0,8mm.

H

HSK-T WERKZEUGE

PDJN WSP	> A105–A111
DDJN WSP	> A105–A111
PCBN & PKD WSP	> B039–B042, B064

SCHNITTDATENEMPFEHLUNGEN	> A074
ERSATZTEILE	> N001
TECHNISCHE DATEN	> P001

H009

# HSK-T SYSTEM

## PDNN

Außendrehen • Kopieren

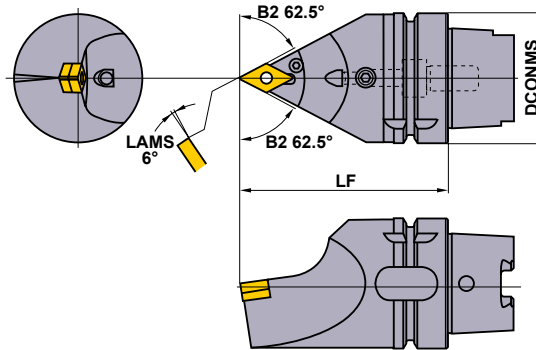
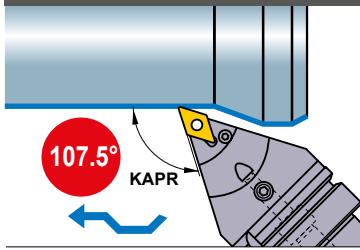

Schichten	Leicht	Mittel
FP (15)	LP (15)	MP (15)
Mittel MK (15)	Mittel-Schruppen RP (15)	Rostfrei MM (15)
G-Klasse R/L (15)	PCBN (15)	

Bestellbezeichnung	Lager	WSP Bezeichnung	Abmessungen (mm)		*3 WT (kg)	*2				*1		
			DCONMS	LF		Unterlegplatte	Befestigungsfeder	Kniehebel	Spannschraube	Stopfen	Schlüssel	
H63TH-PDNNN-H15	●	DN $\odot$ A DN $\odot$ G DN $\odot$ M	1504	63	100	1.6	LLSDN43 (LLSDN42)	LLP14	LLCL24	LLCS108	HGM-PT1/8	HKY30R
H63TH-PDNNN-L15	●			63	140	2.5	LLSDN43 (LLSDN42)	LLP14	LLCL24	LLCS108	HGM-PT1/8	HKY30R

\*1 Spannmoment (N • m) : LLCS108=3.3

\*2 Beim Einsatz von 6.35mm dicken WSP muss die Unterlegplatte LLSDN42 verwendet werden. Die Unterlegplatte für 6.35mm dicke WSP muss separat bestellt werden.

\*3 WT : Werkzeuggewicht

Hinweis 1) Abmaße beziehen sich auf Wendeschneidplatten mit Eckenradius 0,8mm.

## DDNN

Außendrehen • Kopieren **DOPPELKLEMM Ausführung**

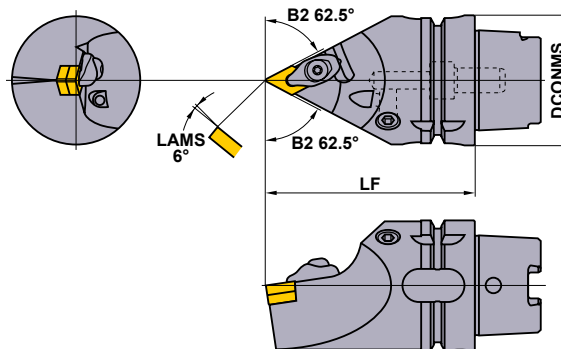
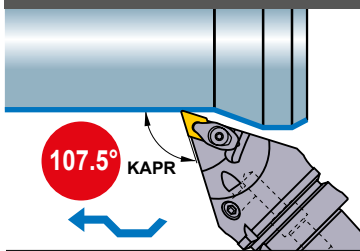

Schichten	Leicht	Mittel
FP (15)	LP (15)	MP (15)
Mittel MK (15)	Mittel-Schruppen RP (15)	Rostfrei MM (15)
G-Klasse R/L (15)	PCBN (15)	

Bestellbezeichnung	Lager	WSP Bezeichnung	Abmessungen (mm)		*3 WT (kg)	*2				*1		
			DCONMS	LF		Unterlegplatte	Befestigungsfeder	Spannfinger	Feder	Spannschraube	Schlüssel	
H63TH-DDNNN-H15	●	DN $\odot$ A DN $\odot$ G DN $\odot$ M	1504	63	100	1.6	LLSDN43 (LLSDN42)	LLP24	DCK2613	DCS1	DC0621T	TKY20F
H63TH-DDNNN-L15	●			63	140	2.5	LLSDN43 (LLSDN42)	LLP24	DCK2613	DCS1	DC0621T	TKY20F

\*1 Spannmoment (N • m) : DC0621T=5.0

\*2 Beim Einsatz von 6.35mm dicken WSP muss die Unterlegplatte LLSDN42 verwendet werden. Die Unterlegplatte für 6.35mm dicke WSP muss separat bestellt werden.

\*3 WT : Werkzeuggewicht

Hinweis 1) Abmaße beziehen sich auf Wendeschneidplatten mit Eckenradius 0,8mm.

HSK-T WERKZEUGE

● : Lagerstandard.

PDNN WSP	> A105 – A111
DDNN WSP	> A105 – A111
PCBN & PKD WSP	> B039 – B042, B064
SCHNITTDATENEMPFEHLUNGEN	> A074

# DDJN

Außendrehen •  
Plandrehen

DOPPELKLEMM Ausführung

Schichten	Leicht
FP  (15)	LP  (15)
Mittel	Mittel
MP  (15)	MK  (15)
Mittel-Schruppen	Rostfrei
RP  (15)	MM  (15)

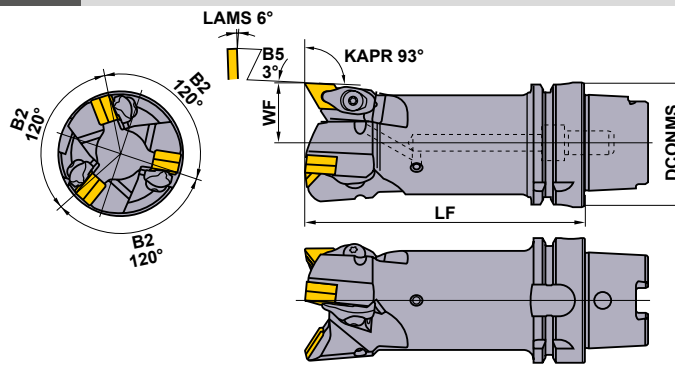
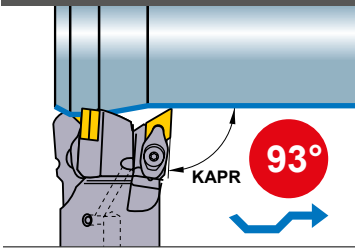

Nur Linksauführung.

Bestellbezeichnung	Lager	WSP Bezeichnung	Abmessungen (mm)			*3 WT (kg)	*2					*1	
	L		DCONMS	LF	WF		Unterleg- platte	Befestigungs- feder	Spannfinger	Feder	Spann- schraube	Schlüssel	
<b>H63TH-DDJNL-L15-3</b>	●	DN○A DN○G DN○M DNMX	1504	63	140	30	2.2	LLSDN43 (LLSDN42)	LLP24	DCK2613	DCS1	DC0621T	TKY20F

\*1 Spannmoment (N • m) : DC0621T=5.0

\*2 Beim Einsatz von 6.35mm dicken WSP muss die Unterlegplatte LLSDN42 verwendet werden. Die Unterlegplatte für 6.35mm dicke WSP muss separat bestellt werden.

\*3 WT : Werkzeuggewicht

Hinweis 1) Abmaße beziehen sich auf Wendeschneidplatten mit Eckenradius 0,8mm.

DDJN WSP	> A105–A111
PCBN & PKD WSP	> B039–B042, B064
SCHNITTDATENEMPFEHLUNGEN	> A074

ERSATZTEILE	> N001
TECHNISCHE DATEN	> P001

# HSK-T SYSTEM

## PRGC

Außendrehen • Plandrehen • Kopieren



Abb. zeigt Rechtsausführung.

Mittel

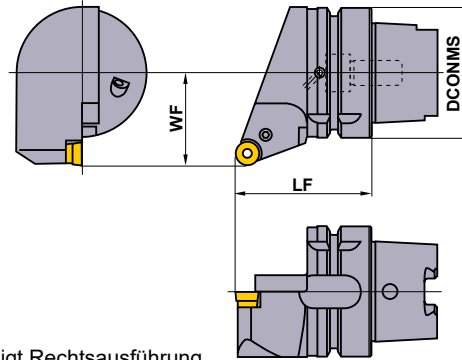
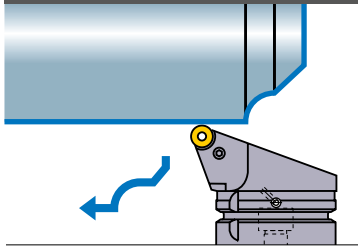

Bestellbezeichnung	Lager		WSP Bezeichnung		Abmessungen (mm)			*2 WT (kg)	Unterleg- platte	Befestigungs- feder	Kniehebel	Spann- schraube *1	Schlüssel
	R	L			DCONMS	LF	WF						
<b>H63TH-PRGCR/L-DX12</b>	●	●	RCMX	1204M0	63	65	45	1.2	LLSRN123	LLP13	LLCL112	LLCS106	HKY25R

\*1 Spannmoment (N • m) : LLCS106=2.2

\*2 WT : Werkzeuggewicht

## PRDC

Außendrehen • Plandrehen • Kopieren

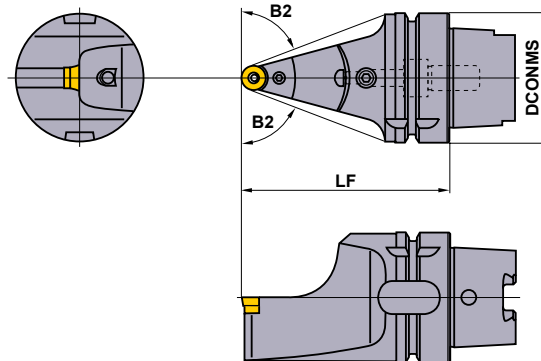
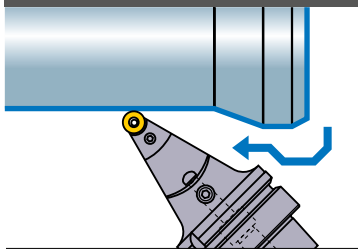

Mittel



Bestellbezeichnung	Lager		WSP Bezeichnung		Abmessungen (mm)			*2 WT (kg)	Unterleg- platte	Befestigungs- feder	Kniehebel	Spann- schraube *1	Stopfen	Schlüssel
	R	L			DCONMS	LF	B2							
<b>H63TH-PRDCN-H12</b>	●	●	RCMX	1204M0	63	100	69°	1.4	LLSRN123	LLP13	LLCL112	LLCS106	HGM-PT1/8	HKY25R
<b>H63TH-PRDCN-L12</b>	●	●			63	140	75°	2.3	LLSRN123	LLP13	LLCL112	LLCS106	HGM-PT1/8	HKY25R

\*1 Spannmoment (N • m) : LLCS106=2.2

\*2 WT : Werkzeuggewicht

## SCHNITTDATENEMPFEHLUNGEN

	Werkstoff	Härte	Fräser Typ	Spanbrecher	Sorte	Schnittgeschw. (m/min)
<b>P</b>	Allg. Baustahl	≤180HB	Mittlere Zerspanung	<b>Standard</b>	<b>UE6110</b>	205–350
	C-Stahl Leg. Stahl	180HB–350HB	Mittlere Zerspanung	<b>Standard</b>	<b>UE6110</b>	150–260
<b>M</b>	Rostfreier Stahl	≤200HB	Mittlere Zerspanung	<b>Standard</b>	<b>US735</b>	70–130

● : Lagerstandard.

PRGC WSP > A154  
PRDC WSP > A154

# SVPB

## Plandrehen • Kopierdrehen

Schichten	Leicht
R/L-F (16)	SV (16)
Mittel MV (16)	Mittel MP (16)
PCBN (16)	

Abb. zeigt Rechtsausführung.

Bestellbezeichnung	Lager		WSP Bezeichnung	Abmessungen (mm)				*2 WT (kg)	*1				
	R	L		DCONMS	LF	WF	WF2		Unterlegplatte	Befestigungsfeder	Spannschraube	Schlüssel	
<b>H63TH-SVPBR/L-DX16</b>	●	●	VB <sup>○</sup> T VB <sup>○</sup> W	1604	63	65	45	3.8	1.1	SPSVN32	BCP141	TS35D	TKY15F

\*1 Spannmoment (N • m) : TS35D=3.5

\*2 WT : Werkzeuggewicht

Hinweis 1) Abmaße beziehen sich auf Wendeschneidplatten mit Eckenradius 0,8mm.

# SVVB

## Plandrehen • Kopierdrehen

Schichten	Leicht
R/L-F (16)	SV (16)
Mittel MV (16)	Mittel MP (16)
PCBN (16)	

Bestellbezeichnung	Lager		WSP Bezeichnung	Abmessungen (mm)			*2 WT (kg)	*1					
	R	L		DCONMS	LF	B2		Unterlegplatte	Befestigungsfeder	Spannschraube	Stopfen	Schlüssel	
<b>H63TH-SVVBH-H16</b>	●	●	VB <sup>○</sup> T VB <sup>○</sup> W	1604	63	100	66.5°	1.3	SPSVN32	BCP141	TS35D	HGM-PT1/8	TKY15F
<b>H63TH-SVVBH-L16</b>	●	●	VB <sup>○</sup> T VB <sup>○</sup> W	1604	63	140	72.5°	2.2	SPSVN32	BCP141	TS35D	HGM-PT1/8	TKY15F

\*1 Spannmoment (N • m) : TS35D=3.5

\*2 WT : Werkzeuggewicht

Hinweis 1) Abmaße beziehen sich auf Wendeschneidplatten mit Eckenradius 0,8mm.

## SCHNITTDATENEMPFEHLUNGEN

Werkstoff	Härte	Fräser Typ	Spanbrecher	Sorte	Schnittgeschw. (m/min)	
<b>P</b>	Allg. Baustahl	≤180HB	Schlichtzerspanung	<b>F</b>	<b>AP25N</b>	250 (150–300)
		Mittlere Zerspanung	<b>MP</b>	<b>MC6015</b>	200 (150–250)	
	C-Stahl Leg. Stahl	180HB–350HB	Schlichtzerspanung	<b>F</b>	<b>AP25N</b>	210 (150–260)
			Mittlere Zerspanung	<b>MP</b>	<b>MC6025</b>	170 (120–210)
<b>M</b>	Rostfreier Stahl	≤200HB	Mittlere Zerspanung	<b>MM</b>	<b>MP7035</b>	100 (70–120)
<b>K</b>	Guss	Zugfestigkeit ≤350MPa	Mittlere Zerspanung	<b>MK</b>	<b>MC5015</b>	170 (140–200)

SVPB WSP > A164–A166

SVVB WSP > A164–A166

PCBN WSP > B059

ERSATZTEILE > N001

TECHNISCHE DATEN > P001

# HSK-T SYSTEM

**MG**

Stechen



Abb. zeigt Rechtsausführung.

Bestellbezeichnung	Lager		WSP Bezeichnung	Abmessungen (mm)					*2 WT (kg)	Klemmbrücke	Spannschraube *1	Feder	Schlüssel
	R	L		DCONMS	CW	CDX	LF	WF					
<b>H63TH-MGHR/L-DX4315</b>	★	★	MGTR/L 43125   43470	63	1.25	1.2	65	45	1.2	MTK1R/L	HBH06020	MES3	HKY40R
				63	1.45	1.5	65	45	1.2				
<b>H63TH-MGHR/L-DX4323</b>	★	★		63	1.5 ≤ CW ≤ 2.3	3	65	45	1.2				
<b>H63TH-MGHR/L-DX4333</b>	★	★		63	2.3 < CW ≤ 3.3	4.5	65	45	1.2				
				63	3.3 < CW ≤ 4.7	4.5	65	45	1.2				

\*1 Spannmoment (N • m) : HBH06020=7.0

\*2 WT : Werkzeuggewicht

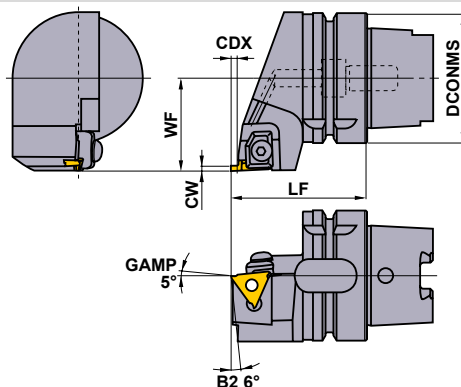
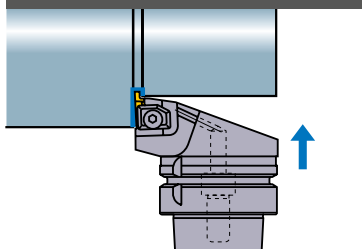
H

HSK-T WERKZEUGE

## SCHNITTDATENEMPFEHLUNGEN

	Werkstoff	Härte	Sorte	Schnittgeschw. (m/min)	Vorschub (mm/U.)
<b>P</b>	C-Stahl Leg. Stahl	180–350HB	<b>VP20MF</b>	120 (100–140)	0.10 (0.03–0.18)
			<b>NX2525</b>	130 (100–160)	0.12 (0.03–0.2)
<b>M</b>	Rostfreier Stahl	≤200HB	<b>VP20MF</b>	120 (100–140)	0.10 (0.03–0.18)
<b>K</b>	Guss	Zugfestigkeit ≤350MPa	<b>VP20MF</b>	120 (100–140)	0.10 (0.03–0.18)

● : Lagerstandard. ★ : Lagerstandard in Japan.

(10 Wendeschneidplatten pro Verpackung) (PCBN Wendeschneidplatten sind in Einzelverpackungen verfügbar.)

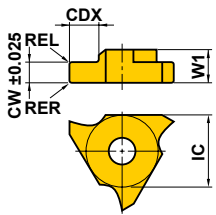

# WSP

Bestellbezeichnung	Lager						Abmessungen (mm)					Abbildung	
	Beschichtet		Cermet		Hartmetall		CW	CDX	IC	W1	RER/L		LE
	VP20MF		NX2525		UTi20T								
	R	L	R	L	R	L							
MGTR/L43125	★	★	★	★	●	●	1.25	1.2	12.7	4.76	0.2	2.7	<b>MGTR/L...</b> 
MGTR/L43145	★	★		★	●	★	1.45	1.5	12.7	4.76	0.2	—	
MGTR/L43150	★	★	★	●	●	●	1.5	3	12.7	4.76	0.2	2.7	
MGTR/L43175	★	★	★	★	●	●	1.75	3	12.7	4.76	0.2	—	
MGTR/L43200	★	★	★	●	●	●	2	3	12.7	4.76	0.2	2.7	
MGTR/L43230	★	★	●	★	●	●	2.3	3	12.7	4.76	0.2	—	
MGTR/L43250	★	★	★	★	●	●*	2.5	4.5	12.7	4.76	0.3	2.7	
MGTR/L43260	★	★	★		●	●	2.6	4.5	12.7	4.76	0.3	—	
MGTR/L43270	★	★			●	★	2.7	4.5	12.7	4.76	0.3	—	
MGTR/L43280		★		★	●	●	2.8	4.5	12.7	4.76	0.3	—	
MGTR/L43300	★	★	★	★	●	●*	3	4.5	12.7	4.76	0.3	2.7	
MGTR/L43320	★				●	●	3.2	4.5	12.7	4.76	0.3	—	
MGTR/L43330		★		★	●	●	3.3	4.5	12.7	4.76	0.3	—	
MGTR/L43350	★	★	★	★	●	●*	3.5	4.5	12.7	4.76	0.3	2.7	
MGTR/L43400	★	★	★		●	●*	4	4.5	12.7	4.76	0.3	2.7	
MGTR/L43420	★	★	★		●	●	4.2	4.5	12.7	4.76	0.4	—	
MGTR/L43430	★	★	★		●	●	4.3	4.5	12.7	4.76	0.4	—	
MGTR/L43450	★	★	●	★	●	●	4.5	4.5	12.7	4.76	0.4	—	
MGTR/L43470	★	★	★	★	●	★	4.7	4.5	12.7	4.76	0.4	—	

# HSK-T SYSTEM

## MMTE

### Gewindedrehen

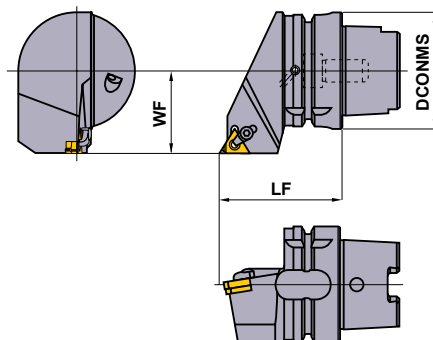
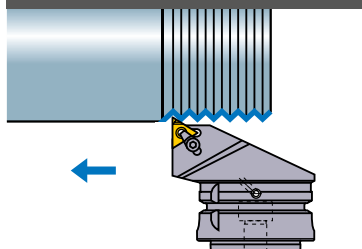

Nur Rechtsausführung lieferbar.

Bestellbezeichnung	Lager	WSP Bezeichnung	Abmessungen (mm)			*2 WT (kg)	Klemmbrücke	Spann- schraube	Anschlag- ring	Unterleg- platte	Schraube Unterlegplatte	Schlüssel
	R		DCONMS	LF	WF							
<b>H63TH-MMTER-DX16</b>	★	MMT16ER	63	65	45	1.2	SETK51	SETS51	CR4	CTE32TP15	HFC03008	TKY15F HKY20R

\*1 Spannmoment (N • m) : SETS51=3.5, HFC03008=1.5

\*2 WT : Werkzeuggewicht

## MMTEN

### Gewindedrehen

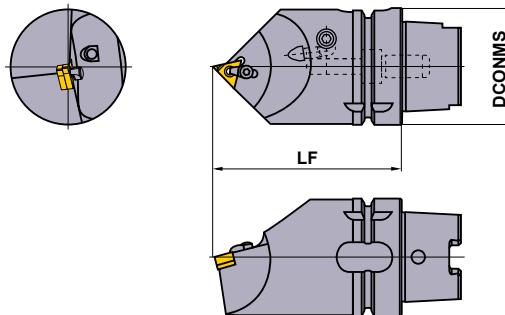
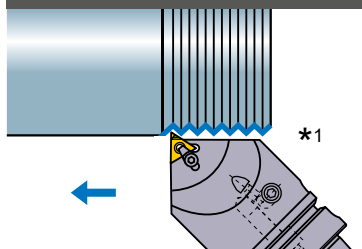

Nur Rechtsausführung lieferbar.

Bestellbezeichnung	Lager	WSP Bezeichnung	Abmessungen (mm)		*3 WT (kg)	Klemmbrücke	Spann- schraube	Anschlag- ring	Unterleg- platte	Schraube Unterlegplatte	Stopfen	Schlüssel
	R		DCONMS	LF								
<b>H63TH-MMTENR-H16</b>	★	MMT16ER	63	100	1.7	SETK51	SETS51	CR4	CTE32TP15	HFC03008	HGM-PT1/8	TKY15F HKY20R
<b>H63TH-MMTENR-L16</b>	★			140							2.7	

\*1 45° Einsatz.

\*2 Spannmoment (N • m) : SETS51=3.5, HFC03008=1.5

\*3 WT : Werkzeuggewicht

HSK-T WERKZEUGE

★ : Lagerstandard in Japan.

**MT****Gewindedrehen**

Abb. zeigt Rechtsausführung.

Bestellbezeichnung	Lager		WSP Bezeichnung	Abmessungen (mm)			*2 WT (kg)		*1			
	R	L		DCONMS	LF	WF		Klemmbrücke	Spannschraube	Feder	Schlüssel	
<b>H63TH-MTHR/L-DX43</b>	★	★	MTTR/L	43	63	65	45	1.2	MTK1R/L	HBH06020	MES3	HKY40R

\*1 Spannmoment (N • m) : HBH06020=7.0

\*2 WT : Werkzeuggewicht

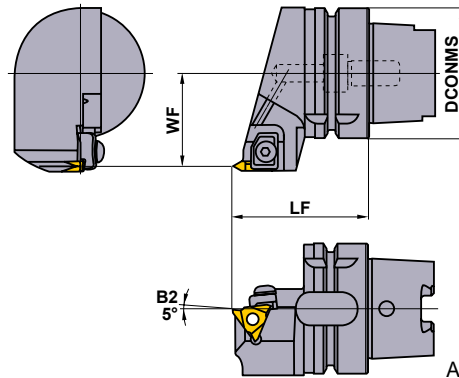
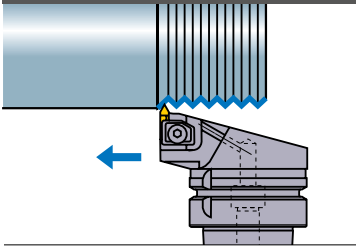
**H**

HSK-T WERKZEUGE

**SCHNITTDATENEMPFEHLUNGEN**

	Werkstoff	Härte	Sorte	Schnittgeschw. (m/min)
<b>P</b>	Allg. Baustahl	≤180HB	<b>UP20M</b>	140 (100–180)
			<b>UTi20T</b>	120 (100–150)
	C-Stahl Leg. Stahl	180HB–350HB	<b>UP20M</b>	120 (100–150)
			<b>UTi20T</b>	100 (70–120)
<b>M</b>	Rostfreier Stahl	≤200HB	<b>UP20M</b>	120 (80–150)
			<b>UTi20T</b>	100 (70–130)
<b>K</b>	Guss	Zugfestigkeit ≤350MPa	<b>UP20M</b>	80 (60–100)
			<b>UTi20T</b>	80 (60–100)
			<b>HTi10</b>	100 (70–130)

WSP > H018  
 ERSATZTEILE > N001  
 TECHNISCHE DATEN > P001

**H017**

# HSK-T SYSTEM

## WSP

Form	Bestellbezeichnung	Klasse	Beschichtung				ISO Steigung mm (Gang/Zoll)	Abmessungen (mm)			Abbildung
			UP20M	Cermet NX2525	Hartmetall UT120T	HT110		IC	W1	RE	
Allgemein 60°	MTTR436000	G		●	●		-0.8	12.7	4.76	0	<p>MTTR/L(60°) (G Toleranz)</p> <p>Abb. zeigt rechte WSP.</p>
	MTTR436001	G	★	●	●	★	1.0-1.75	12.7	4.76	0.1	
	MTTL436001	G	★		●	★	1.0-1.75	12.7	4.76	0.1	
	MTTR436002	G	★	●	●	★	2.0-2.5	12.7	4.76	0.2	
	MTTL436002	G		●	●		2.0-2.5	12.7	4.76	0.2	
	MTTR436003	G	★	●	●	★	3.0-3.5	12.7	4.76	0.3	
	MTTL436003	G		●	●		3.0-3.5	12.7	4.76	0.3	
	MTTR436004	G		●	●		4.0-4.5	12.7	4.76	0.4	
Allgemein 55°	MTTR435501	G		●	★		(28-10)	12.7	4.76	0.1	<p>MTTR(55°) (G Toleranz)</p> <p>Abb. zeigt rechte WSP.</p>
	MTTR435502	G		●	●		(16-8)	12.7	4.76	0.2	
	MTTR435503	G		●	●		(11-8)	12.7	4.76	0.3	

### STANDARD SCHNITTIEFE

### METRISCHES SCHRAUBENGEWINDE

Maße : mm

- Die rechte Tabelle zeigt die empfohlenen Schnitttiefe für metr. Aussengewinde (ISO).
- Bei der Verwendung von Cermet Sorten oder Bearbeitung von rostfreien Stählen, erhöhen Sie die Anzahl der Durchgänge um 2-3 Mal.

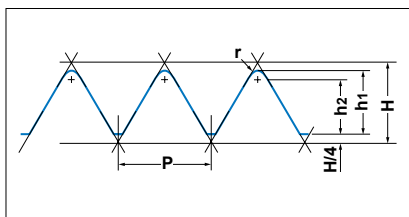

P (Steigung)	0.75	1.00	1.25	1.50	1.75	2.00	2.50	3.00	3.50	4.00	4.50	
h1	0.46	0.61	0.77	0.92	1.07	1.23	1.53	1.84	2.15	2.45	2.76	
h2	0.35	0.47	0.59	0.70	0.82	0.94	1.17	1.41	1.65	1.87	2.11	
r (Radius)	0.11	0.14	0.18	0.22	0.25	0.29	0.36	0.43	0.50	0.58	0.65	
Anzahl der Durchgänge	1	0.18	0.20	0.20	0.25	0.25	0.25	0.30	0.30	0.35	0.35	0.40
	2	0.13	0.15	0.18	0.20	0.20	0.25	0.25	0.25	0.30	0.30	0.35
	3	0.10	0.10	0.12	0.15	0.20	0.20	0.20	0.25	0.25	0.25	0.30
	4	0.05	0.10	0.12	0.15	0.15	0.15	0.20	0.20	0.20	0.25	0.25
	5		0.06	0.10	0.10	0.12	0.15	0.15	0.20	0.20	0.25	0.25
	6			0.05	0.07	0.10	0.10	0.10	0.15	0.20	0.20	0.20
	7					0.05	0.08	0.10	0.15	0.15	0.20	0.20
	8						0.05	0.10	0.10	0.15	0.15	0.15
	9							0.08	0.10	0.10	0.15	0.15
	10							0.05	0.09	0.10	0.10	0.15
	11								0.05	0.10	0.10	0.10
	12									0.05	0.10	0.10
	13										0.05	0.10
	14											0.06

Hinweis 1) Der erste Schnitt verursacht eine hohe Belastung auf der Schneidkante, um Beschädigungen zu vermeiden. Reduzieren Sie die Schnitttiefe auf 0.4-0.5mm.

# WERKZEUGHALTER DREHEN

Außendrehen • Plandrehen

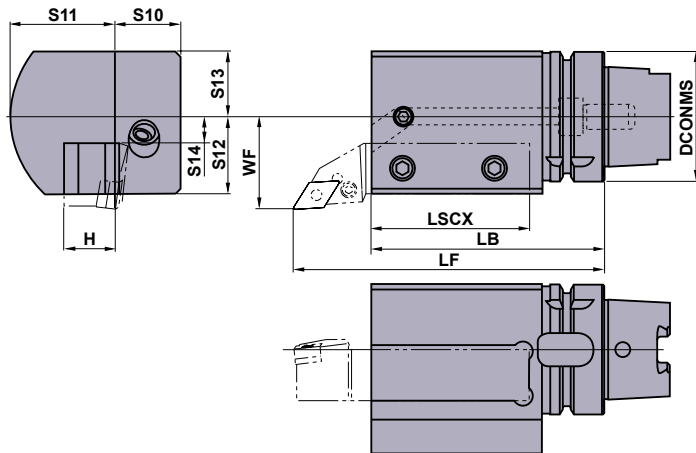

■ Diese Halteraufnahme ist für 25x25mm Halter.  
Bitte kürzen Sie den Halter wie in dem  
Schaubild.





Abb. zeigt Rechtsausführung.

Bestellbezeichnung	Lager		Abmessungen (mm)										* WT (kg)	 		
	R	L	DCONMS	LF	LB	LSCX	H	S10	S11	WF	S14	S12		S13	Spannschraube	Stopfen
<b>H63TH-EV2525R/L-112</b>	★	★	63	150	112	77	25	32	53	45	13	38	32	3.9	HSS12025	HGM-PT1/8

\* WT : Werkzeuggewicht

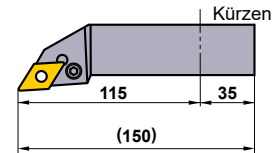

# WERKZEUGHALTER DREHEN

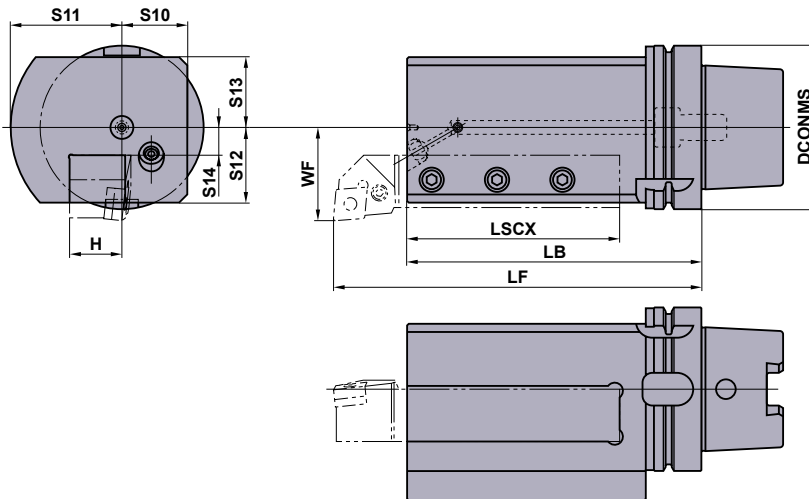
Außendrehen • Plandrehen



■ Diese Aufnahme ist für Werkzeuge der  
Größen 32x32 und 32x25 vorgesehen.

Abb. zeigt Rechtsausführung.

Bestellbezeichnung	Lager		Abmessungen (mm)										* WT (kg)	 		
	R	L	DCONMS	LF	LB	LSCX	H	S10	S11	WF	S14	S12		S13	Spannschraube	Stopfen
<b>H100TH-EV3232R/L-180</b>	★	★	100	220	180	130	32	40	68	57	17	46	43	11.7	HSS14035	HSS06006

Hinweis 1) Kann auch mit 32 x 32mm und 32 x 25mm Halter verwendet werden. Auch 25 x 25mm Halter können mit 7mm Platten eingesetzt werden.

\* WT : Werkzeuggewicht

H

HSK-T WERKZEUGE

# HSK-T SYSTEM

## WERKZEUGHALTER DREHEN Außendrehen • Plandrehen

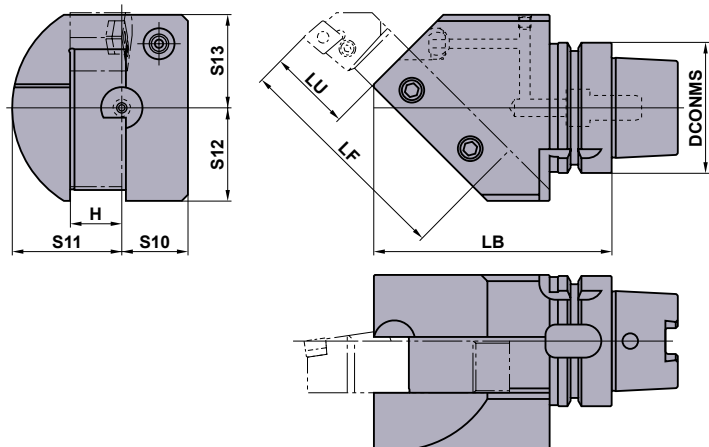

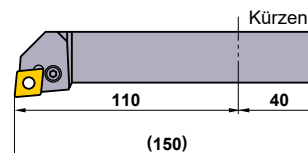

■ Diese Halteraufnahme ist für 25x25mm Halter. Bitte kürzen Sie den Halter wie in dem Schaubild.



Mitsubishi Materials produziert und vertreibt diese Werkzeuge unter einer Lizenz der MORI SEIKI CO., LTD unter dem Patent Nr. 3720202.

Abb. zeigt Rechtsausführung.

Bestellbezeichnung	Lager		Abmessungen (mm)									* WT (kg)	 Spannschraube	 Stopfen
	R	L	DCONMS	LB	LU	LF	H	S10	S11	S12	S13			
H63TH-EN2525R/L-115	★	★	63	115	40	110	25	32	53	45	45	3.7	HSS12030	HSS06006

\* WT : Werkzeuggewicht

## WERKZEUGHALTER DREHEN Außendrehen • Plandrehen

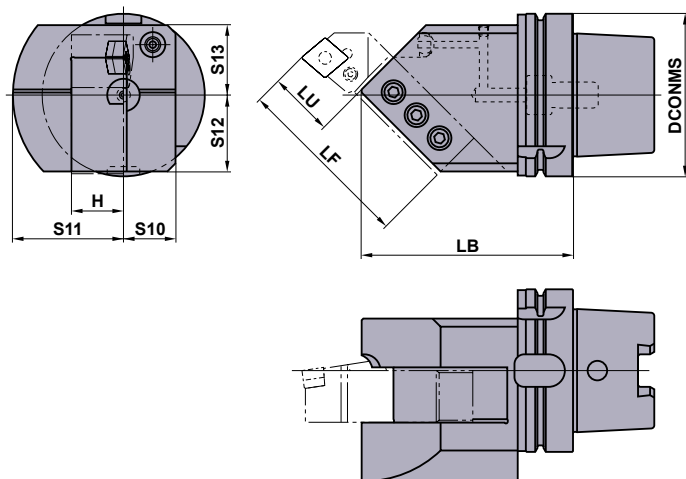

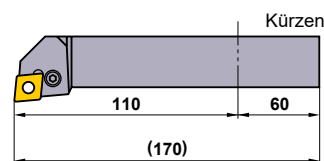

■ Diese Aufnahme ist für Werkzeuge der Größen 32x32 und 32x25 vorgesehen. Bitte kürzen Sie den Halter wie in dem Schaubild.



Mitsubishi Materials produziert und vertreibt diese Werkzeuge unter einer Lizenz der MORI SEIKI CO., LTD unter dem Patent Nr. 3720202.

Abb. zeigt Rechtsausführung.

Bestellbezeichnung	Lager		Abmessungen (mm)									* WT (kg)	 Spannschraube	 Stopfen
	R	L	DCONMS	LB	LU	LF	H	S10	S11	S12	S13			
H100TH-EN3232R/L-130	★	★	100	130	40	110	32	32	68	47	43	6.6	HSS14030	HSS06006

Hinweis 1) Kann auch mit 32 x 32mm und 32 x 25mm Halter verwendet werden. Auch 25 x 25mm Halter mit 7mm Platten eingesetzt werden.

\* WT : Werkzeuggewicht

# WERKZEUGHALTER DREHEN

Außendrehen • Plandrehen

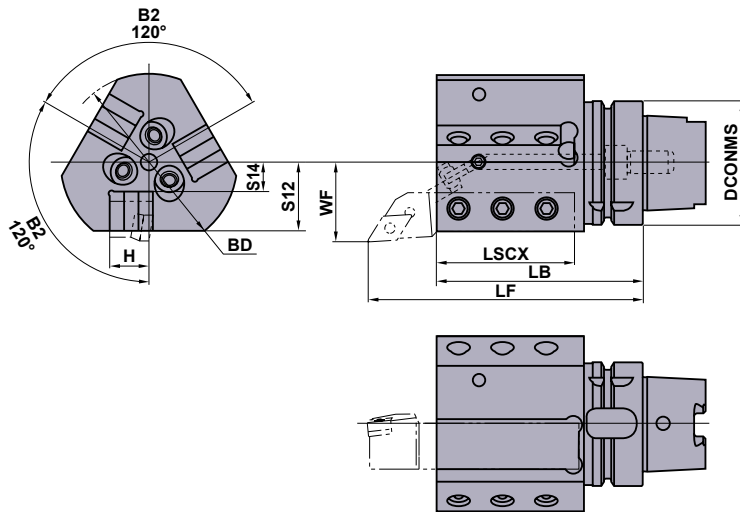

■ Diese Halteraufnahme ist für 20x20mm Halter. Bitte kürzen Sie den Halter wie in dem Schaubild.



Abb. zeigt Rechtsausführung.

Bestellbezeichnung	Lager		Abmessungen (mm)									* WT (kg)			
	R	L	DCONMS	LF	LB	LSCX	H	BD	WF	S14	S12		Spannschraube	Stopfen	Stopfen
H63TH-EV2020R/L-105-3	★	★	63	140	105	70	20	90	40	15	35	2.9	HSS12030	HSS05012	HSS06006

\* WT : Werkzeuggewicht

# WERKZEUGHALTER FÜR BOHRSTANGEN

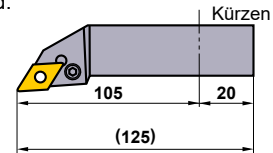
Ausdrehen

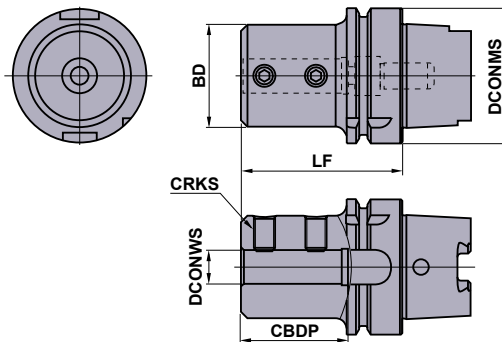

Bestellbezeichnung	Lager	Abmessungen (mm)						* WT (kg)	
		DCONMS	BD	DCONWS	LF	CBDP	CCRKS		Spannschraube
H63TH-B08-65	★	63	28	8	65	40	M8	0.9	HSS08010
H63TH-B10-70	★	63	35	10	70	45	M8	1.0	HSS08012
H63TH-B12-70	★	63	42	12	70	45	M8	1.1	HSS08012
H63TH-B16-75	★	63	48	16	75	50	M10	1.3	HSS10016
H63TH-B20-75	★	63	52	20	75	50	M10	1.4	HSS10016
H63TH-B25-83	★	63	62	25	83	58	M12	1.7	HSS12016
H63TH-B32-87	★	63	62	32	87	62	M12	1.7	HSS12016
H63TH-B40-97	★	63	65	40	97	72	M16	1.8	HSS16012

Hinweis 1) Bitte kürzen Sie Drehhalter oder Bohrstanzen um die Auskrägung zu reduzieren. Die ist auch für Mehrfachhalter erforderlich.

\* WT : Werkzeuggewicht

H

HSK-T WERKZEUGE



# HSK-T SYSTEM

## WERKZEUGHALTER, STECHEN Ausdrehen

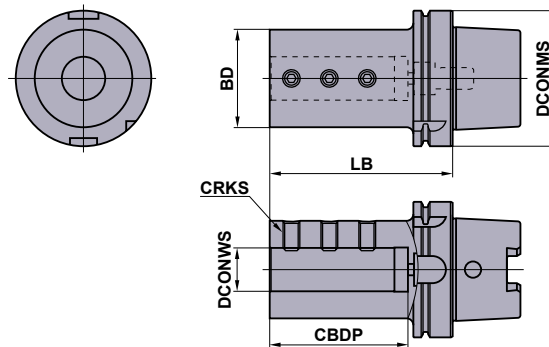



Bestellbezeichnung	Lager	Abmessungen (mm)						* WT (kg)	 Spannschraube
		DCONMS	BD	DCONWS	LB	CBDP	CRKS		
H100TH-B25-120	★	100	62	25	120	88	M12	3.9	HSS12016
H100TH-B32-135	★	100	72	32	135	102	M12	4.8	HSS12018
H100TH-B40-150	★	100	82	40	150	117	M16	5.9	HSS16020
H100TH-B50-180	★	100	92	50	180	147	M16	7.7	HSS16020

Hinweis 1) In Kombination mit Hülsen können auch runde Bohrstäbe verwendet werden.

\* WT : Werkzeuggewicht

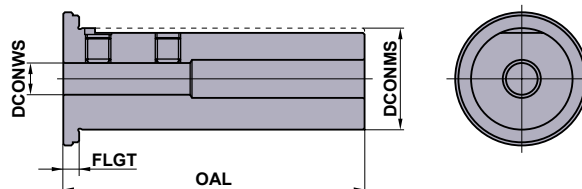
## BOHRSTANGENHÜLSE FÜR H100TH-B32-135



Bestellbezeichnung	Lager	Abmessungen (mm)				* WT (kg)	 Spannschraube
		DCONWS	DCONMS	OAL	FLGT		
SL3208-90	★	8	32	95	5	0.6	HSS06008
SL3210-90	★	10	32	95	5	0.5	HSS08008
SL3212-90	★	12	32	95	5	0.5	HSS08008
SL3216-90	★	16	32	95	5	0.5	HSS08006
SL3220-90	★	20	32	95	5	0.4	HSS08005

Hinweis 1) Diese Hülse sind ausschließlich mit der Aufnahme H100TH-B32-135 kompatibel.

\* WT : Werkzeuggewicht



# Notizen

---

A series of horizontal dashed lines for writing notes, spanning the width of the page.

# ERSATZTEILE

IDENTIFIZIERUNG ..... N002

ERSATZTEILE

- KLEMMSCHRAUBEN ..... N003
- SCHRAUBE ..... N009
- EINSTELLSCHRAUBE / PRÄZISIONS-STELLMUTTER ..... N010
- UNTERLEGPLATTE ..... N011
- BEFESTIGUNGSFEDER UND KNIEHEBEL ..... N014
- KNIEHEBEL ..... N015
- SPANNPRATZE ..... N015
- SPANBRECHER ..... N017
- KUPFERPASTEN ..... N018



# IDENTIFIZIERUNG

## IDENTIFIZIERUNG VON KLEMMSCHRAUBEN (Grobgewinde in Rechtsausführung)

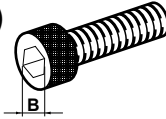

**H SC 060 05**

Länge

Beispiel	
Symbol	L
05	5
10	10
20	20
30	30

Schrauben Durchmesser

Beispiel	
Symbol	d
050	M5
060	M6

### Hexagonale Lochabmessungen

Durchmesser	Gewindesteigung	B Abmessungen			
		HBH	HFC	HSC	HS $\odot$
M2	0.4	—	—	1.5	0.9
M2.5	0.45	—	—	2	1.3
M3	0.5	2	2	2.5	1.5
M4	0.7	2.5	2.5	3	2
M5	0.8	3	3	4	2.5
M6	1	4	4	5	3
M8	1.25	5	5	6	4
M10	1.5	6	6	8	5

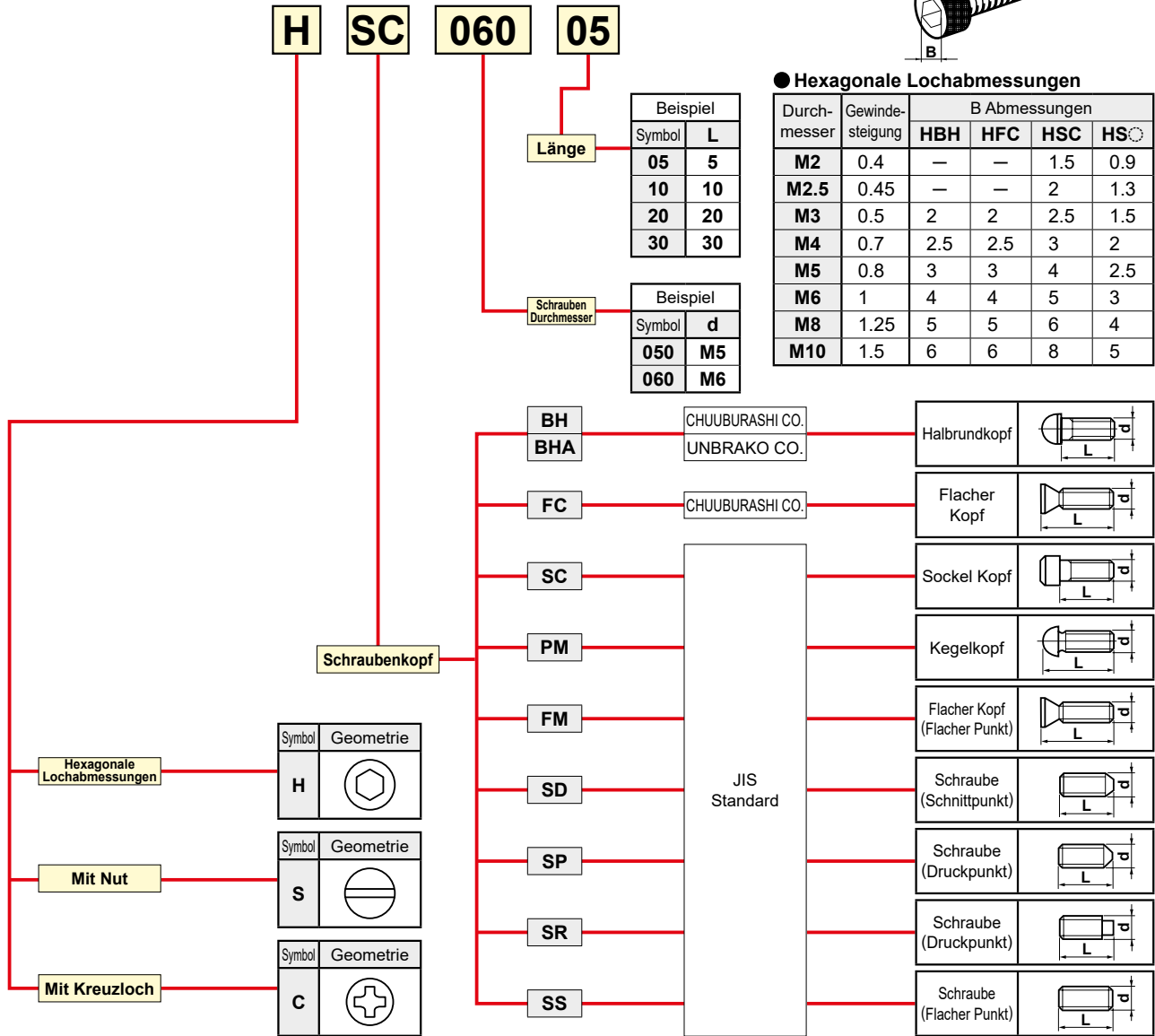

N

ERSATZTEILE

## IDENTIFIZIERUNG VON SCHLÜSSEL

**HKY 15 R**

Symbol	Schlüssel
HKY	Hexagonaler Schlüssel
TKY	Torx Schlüssel
RKY	R Schlüssel
TIP	Torx plus Schlüssel

Hexagonaler Schlüssel	
Symbol	B
15	1.5
20	2
25	2.5
30	3
35	3.5
40	4
50	5
60	6

Torx Schlüssel		
Symbol	B	Größe
06	1.7	T6
08	2.3	T8
10	2.7	T10
15	3.3	T15
20	3.8	T20
25	4.4	T25
27	5.0	T27
30	5.5	T30

Torx plus Schlüssel		
Symbol	B	Größe
06	1.8	6IP
07	2.1	7IP
08	2.4	8IP
10	2.8	10IP
15	3.4	15IP

**IMX 10 - WR**

Symbol	Schlüssel
IMX	Schlüssel für iMX Serie

Hexagonaler Schlüssel	
Symbol	B
10	8
12	10
16	13
20	16
25	20

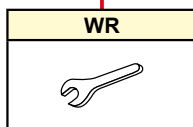

R	Standard L-Schlüssel	
L	L-Schlüssel in langer Ausführung	
T	T-Schlüssel	
F	Flaggen-schlüssel	
FS	Flaggen-schlüssel	
W	Flaggen-schlüssel	
D	Schraubendreher	
DS	Schraubendreher	
S	Schlüssel	

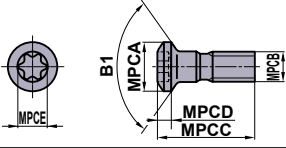
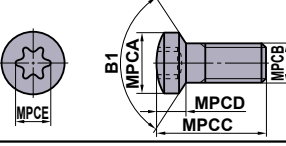
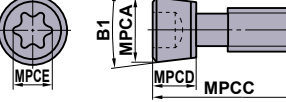
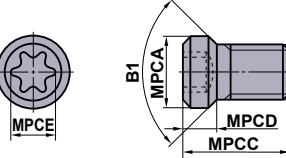
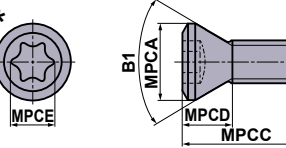
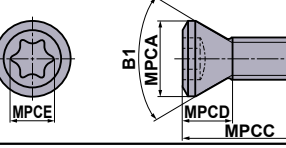
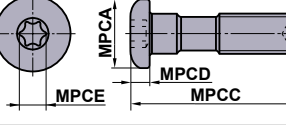
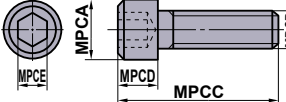

# ERSATZTEILE

## KLEMMSCHRAUBEN

Geometrie	Bestell- bezeichnung	Abmessungen (mm)					Winkel B1	MPCDS	TQ (N·m)	Werkzeughalter
		MPCA	MPCB	MPCC	MPCD	MPCE				
	AJS3010T10	5	M3×0.5	10	1.5	2.8	120°	T10	2.5	Profil Halter (⊕C032) AJX (⊕K180) AJX (⊕K180)
	AJS4012T15	7	M4×0.7	12	2.2	3.4	120°	T15	3.5	
	AJS5014T25	8	M5×0.8	14	2.7	4.5	120°	T25	7.5	
	BRS103	5	M3×0.5	9.9	2.9	3.4	120°	T15	3.5	
	BRS105	8	M5×0.8	13.8	3.8	4.5	120°	T25	7.5	
	CAS51T	7.9	M5×0.8	19	5	4.5	10°	T25	8.5	
 	CS200T	3.2	M2×0.4	5	1.6	1.8	90°	T6	0.6	F Bohrstange (⊕E027)
	CS250T	3.7	M2.5×0.45	6	1.8	2.4	90°	T8	1.0	Fräswerkzeug-Serien (⊕K001)
	* CS250560T	3.9	M2.5×0.45	5.2	2.5	2.4	60°	T8	1.0	BRP (⊕K190)
	CS300590T	4.1	M3×0.5	5.5	2.1	2.4	90°	T8	1.0	DCCC (⊕K200)
	CS300790TS	4.7	M3×0.5	7	2.3	2.8	90°	T10	2.0	
	CS300890T	4.1	M3×0.5	8	2.1	2.4	90°	T8	1.0	
	CS350690T	4.8	M3.5×0.6	6.5	2.4	2.8	90°	T10	2.5	
	* CS350760T	5.5	M3.5×0.6	7	4.0	3.4	60°	T15	3.5	MMTI Bohrstange (⊕G026) BRP (⊕K190) DCCC (⊕K200)
	CS350790T	4.8	M3.5×0.6	7	2.4	2.8	90°	T10	3.5	
	* CS350860T	5.5	M3.5×0.6	8.4	4.0	3.4	60°	T15	3.5	
	CS350990T	4.8	M3.5×0.6	9	2.4	2.8	90°	T10	2.5	
	CS400990T	6.0	M4×0.7	9	2.8	3.4	90°	T15	3.5	AL Halter (⊕C034)
	CS401160T	5.7	M4×0.7	11	4.5	3.4	60°	T15	3.5	
	CS401990T	6.0	M4×0.7	19	3.0	3.9	90°	T20	3.5	
	CS451190T	6.3	M4.5×0.75	11	2.9	3.9	90°	T20	5.0	
	* CS501160T	7.0	M5×0.8	11	3.6	3.9	60°	T20	5.0	AHX640S (⊕K041)
CS501290T	7.0	M5×0.8	11	3.5	4.5	90°	T25	7.5		
* CS5015060T	7.2	M5×0.8	15	2.4	3.9	60°	T20	5.0		
CS502190T	8.5	M5×0.8	21	4.0	5.1	90°	T27	7.5		
CS6016060T	8.5	M6×1.0	16	4.5	4.5	60°	T25	7.5		
	CSF401260T	7.2	M4×0.5	12	5.2	3.9	60°	T20	5.0	PMR (⊕K236)
	DC0520T	8.5	M5×0.8	22.5	2.5	3.4	—	T15	3.5	DOPPELKLEMM Halter (⊕C008)
	DC0621T	10.5	M6×1.0	25	4	3.9	—	T20	5.0	DIMPLE BAR-BOHRSTANGE (⊕E015) HSK System (⊕H001)
	DKS4	5.6	M4×0.7	18	3.5	3	—	—	3.3	
DKS5	7.6	M5×0.8	19	4.5	4	—	—	7.0		

# ERSATZTEILE

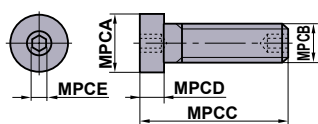
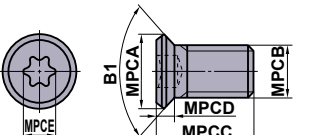
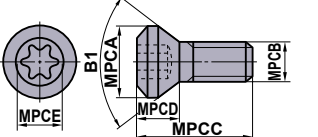
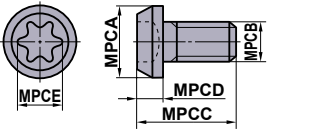
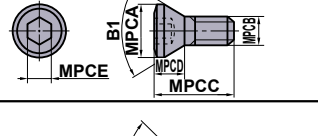
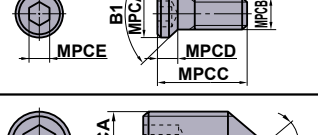
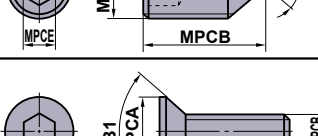
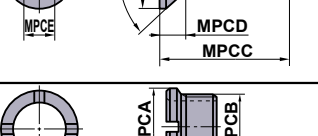
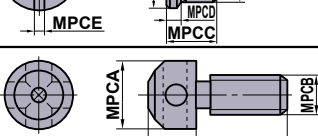
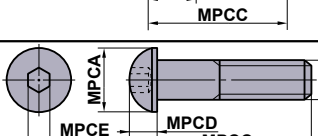
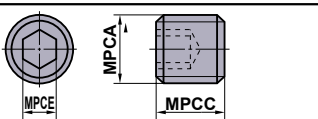
## KLEMMSCHRAUBEN

Geometrie	Bestell- bezeichnung	Abmessungen (mm)					Winkel		TQ (N·m)	Werkzeughalter
		MPCA	MPCB	MPCC	MPCD	MPCE	B1	MPCDS		
	<b>EGS06019</b>	9	M6×1	22.5	3.5	3	—	—	3.3	
	<b>EGS08024</b>	11	M8×1.25	28.5	4.5	4	—	—	7.0	
	<b>FC400890T</b>	5.6	M4×0.7	7.5	1.3	2.8	90°	T10	2.5	AL Halter (☉C035) AL Bohrstange (☉E041)
	<b>GY05016S</b>	8.7	M5×0.8	16	3.5	3.9	90°	T20	5.0	GY Serie (☉F004)
	<b>GY06013M</b>	12	M6×1	18	5	5.6	—	T30	6.0	GY Serie (☉F004)
	<b>HFF06015</b>	10	M6×1	15	6	5	80°	—	8.2	
	<b>HS4L</b>	5.4	M4×0.7	14	2.3	2.5	80°	—	3.8	
	<b>HS5S</b>	6.8	M5×0.8	9	2.8	3	80°	—	3.3	
	<b>HS5L</b>	6.8	M5×0.8	15	2.8	3	80°	—	6.6	
	<b>HSP05008C</b>	M5×0.8	8	—	—	2.5	—	—	2.5	MP Halter (☉C019)
	<b>HY-A1</b>	4.4	M3×0.5	7	2.1	2	82°	—	1.5	
	<b>HY-V1</b>	5.5	M3×0.5	7	2.5	2	82°	—	1.5	
	<b>HY2</b>	5.5	M3×0.5	10	2.5	2	82°	—	1.5	
	<b>HY3</b>	7	M3.5×0.6	12	2.9	2	82°	—	1.5	
	<b>HY4</b>	9.3	M5×0.8	16	3.6	3	82°	—	3.3	
	<b>JSS6</b>	6.9	M6×0.75	4.5	1.5	0.8	—	—	—	
	<b>JSS7</b>	8	M7×0.75	4.4	1.5	1	—	—	—	
	<b>KS1</b>	7	M4×0.7	14	5	—	—	—	—	
	<b>KS2</b>	10	M6×1	18	7	—	—	—	—	
	<b>KS2S</b>	10	M6×1	18	7	—	—	—	—	
	<b>KS12</b>	10	M6×1	26	4	4	—	—	7.0	
	<b>LLR1</b>	M5×0.8	—	3.5	—	2.5	—	—	—	
	<b>LLR2</b>	M6×1	—	5	—	3	—	—	—	

Z

ERSATZTEILE

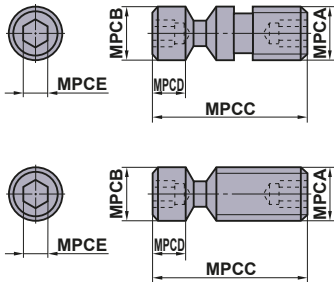
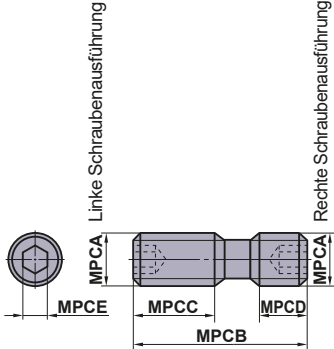
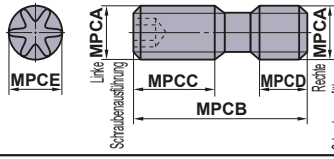
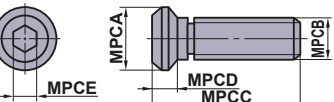

Geometrie	Bestell- bezeichnung	Abmessungen (mm)					Winkel B1	MPCDS	TQ (N·m)	Werkzeughalter
		MPCA	MPCB	MPCC	MPCD	MPCE				
 <p>LLCS103, LLCS105 LLCS112, LLCS125 LLCS205</p> <p>Mit "*" gekennzeichnete Produkte sind am Ende nicht mit der mit MPCB gekennzeichneten Bohrung ausgestattet.</p> <p>Mit "☆" gekennzeichnete Produkte sind am Ende nicht mit der mit MPCA gekennzeichneten Bohrung ausgestattet.</p>	☆ LLCS103	M3×0.5	4	11	4.6	2	—	—	1.5	P Bohrstange (⊕E037) HSK System (⊕H001)
	* LLCS105	M5×0.8	M5×0.8	10	1.5	2	—	—	1.5	
	LLCS106	M6×1	6	16.5	3.5	2.5	—	—	2.2	
	* LLCS106S	M6×1	6	13.4	0.7	2.5	—	—	2.2	
	LLCS108	M8×1.25	8	21	6.5	3	—	—	3.3	
	* LLCS108S	M8×1.25	8	16.5	2	3	—	—	3.3	
	LLCS110	M10×1.5	10	29	8	4	—	—	7.0	
	LLCS112	M12×1	11.9	36.2	9	5	—	—	8.0	
	LLCS125	M5×0.8	M5×0.8	12	2	2	—	—	1.5	
	LLCS205	M5×0.8	M5×0.8	16	4	2	—	—	1.5	
	LLCS206	M6×1	6	26	13	2.5	—	—	2.2	
	LLCS208	M8×1.25	8	24	6.5	3	—	—	3.3	
	LLCS306	M6×1	6	21	4	2.5	—	—	2.2	
	LLCS308	M8×1.25	8	42	27.5	3	—	—	3.3	
	LLCS310	M10×1	10	29	8	4	—	—	7.0	
	LLCS410	M10×1	10	30	6.6	4	—	—	7.0	
	LLCS508	M8×1	8	24	6.5	3	—	—	3.3	
	* LLCS508S	M8×1	8	20.5	3	3	—	—	3.3	
 <p>Linke Schraubenausführung</p> <p>Rechte Schraubenausführung</p> <p>*Ohne Sechskantloch an Schraube in Rechtsausführung</p>	LS1	M6×1	22	8	8	3	—	—	5.0	Fräswerkzeug-Serien (⊕K001)
	LS2	M8×1	29	13	10	4	—	—	8.2	
	LS3	M8×1	32	13	13	4	—	—	8.2	
	* LS4	M6×1	15	8	4	3	—	—	5.0	
	* LS5	M6×1	18	8	5	3	—	—	5.0	
	* LS6	M8×1	24	13	5	4	—	—	8.2	
	* LS7	M8×1	27	13	8	4	—	—	8.2	
	* LS8	M6×0.75	18	7	7	3	—	—	5.0	
	* LS9	M6×0.75	22	8	8	3	—	—	5.0	
	* LS10	M7×0.75	16	6	6	4	—	—	8.2	
	* LS11	M8×1	16	6	6	4	—	—	7.8	
	* LS12	M8×1	24	7	7	4	—	—	7.8	
	* LS13	M8×1	34	12	12	4	—	—	7.8	
	* LS14	M7×0.75	24	10	10	4	—	—	7.8	
	* LS16	M7×0.75	23	11	8	4	—	—	7.8	
* LS18	M7×0.75	14	6	4	4	—	—	7.8		
* LS20	M10×1.5	26	9	9	5	—	—	9.0		
* LS21	M10×1.5	32	12	12	5	—	—	9.0		
 <p>Linke Schraubenausführung</p> <p>Rechte Schraubenausführung</p>	LS10T	M7×0.75	14	6	5	4.5	—	T25	8.0	DOPPELKLEMM Halter (⊕C009)
	LS14T	M7×0.75	24	10	10	4.5	—	T25	8.0	
	LS15T	M7×0.75	18	7	7	4.5	—	T25	8.0	
	LS19T	M6×0.75	11	4	4	3.4	—	T15	5.0	
	LS10TS	M7×0.75	13	6	4	4.5	—	T25	8.5	
	LS0622T	M6×0.75	22	8	8	3.4	—	T15	6.0	
	LS24H	M8×1.25	24	8.5	8.5	4	—	—	8.2	
	MHT1	11	M8×1	18.5	3.5	4	—	—	8.7	

N

ERSATZTEILE

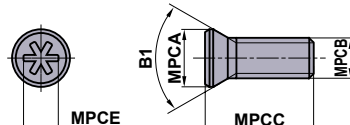
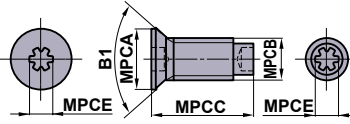
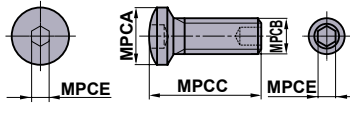
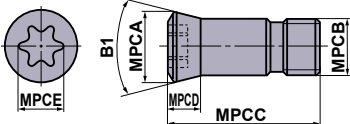
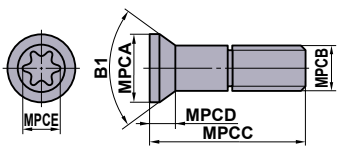
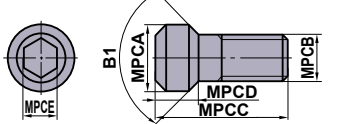
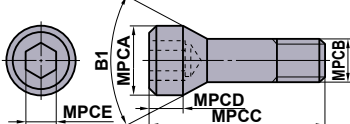
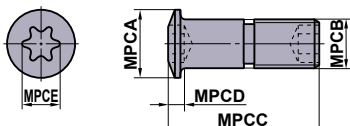
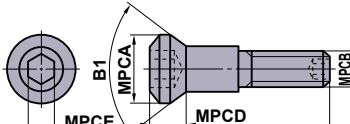
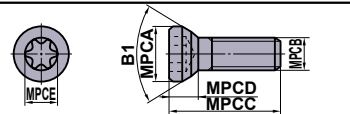
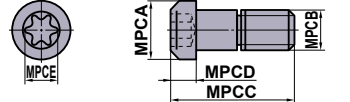
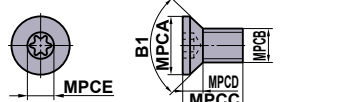

# ERSATZTEILE

## KLEMMSCHRAUBEN

Geometrie	Bestell- bezeichnung	Abmessungen (mm)					Winkel B1	MPCDS	TQ (N·m)	Werkzeughalter
		MPCA	MPCB	MPCC	MPCD	MPCE				
	<b>NS251</b>	3.6	M2.5×0.45	7	—	2.2	60°	—	0.7	<b>BTVH</b> (⊕D016) <b>CSVH</b> (⊕D027) <b>CTAH-S</b> (⊕D020)
	<b>NS401</b>	5.8	M4×0.7	6	—	3.6	60°	—	3.5	
	<b>NS402W</b>	5.85	M4×0.7	10	—	2.2	60°	—	0.7	<b>CTAH</b> (⊕D020) <b>CTBH</b> (⊕D022)
	<b>NS403W</b>	5.85	M4×0.7	12	—	2.2	60°	—	0.7	
	<b>NS404W</b>	5.8	M4×0.7	10	—	2.2	90°	—	0.7	
	<b>NS501W</b>	8	M5×0.8	16	—	2.5	120°	—	2.2	<b>SMALL TOOLS</b> (⊕D001)
	<b>NS502W</b>	8	M5×0.8	20	—	2.5	120°	—	2.2	
	<b>RN-S6</b>	9.5	M6×0.75	20.3	4.6	3.9	61°	T20	5.0	
	<b>RN-S7</b>	11	M7×0.75	24.7	5.2	4.5	61°	T25	7.5	
	<b>RS3008T</b>	4.3	M3×0.35	8.6	2	2.4	61°	T8	1.5	<b>SRF</b> (⊕K212) <b>SUF</b> (⊕K216)
	<b>RS3510T</b>	5	M3.5×0.35	10	2.3	2.8	61°	T10	2.5	
	<b>RS4015T</b>	6	M4×0.5	14	2.7	3.4	61°	T15	3.3	
	<b>RS5020T</b>	8.1	M5×0.5	16.4	3.6	3.9	61°	T20	5.0	
	<b>RS6025T</b>	9.5	M6×0.75	21.5	4.2	4.5	61°	T25	7.5	
	<b>RS8030T</b>	12	M8×0.75	25	5	5.6	61°	T30	10.0	
	<b>S1</b>	3.5	M2×0.4	5.5	2.2	1.5	92°	—	0.6	
	<b>S3</b>	4.5	M3×0.5	7.7	2.4	2	92°	—	1.5	
	<b>S4</b>	5.3	M4×0.7	8	1.8	2.5	62°	—	2.2	
	<b>S5</b>	6.8	M5×0.8	9	2.4	3	62°	—	3.3	
	<b>SD32</b>	12	M8×1.25	28	7.2	6	50°	—	9.5	
	<b>SD40</b>	12	M8×1.25	36	7.2	6	50°	—	9.5	
	<b>SD50</b>	16	M10×1.5	46	8.2	8	50°	—	1.0	
	<b>SD63</b>	16	M10×1.5	61	8.2	8	50°	—	1.0	
	<b>SETS51</b>	6.8	M5×0.8	14.8	1.5	3.4	—	T15	3.5	<b>MMTE</b> Halter (⊕G019) <b>MMTI</b> Bohrstange (⊕G026) <b>HSK System</b> (⊕H001)
	<b>SETS61</b>	8	M6×1	20	1.8	3.9	—	T20	5.0	
	<b>SLCS105</b>	10	M5×0.8	25	6.3	4	90°	—	7.0	<b>WP</b> Halter (⊕C017)
	<b>SLCS106</b>	12	M6×1	32	6.2	4	90°	—	7.0	
	<b>SPS1</b>	8.5	M5×0.8	16	4	4.5	70°	T25	5.0	
	<b>SRS5</b>	6.7	M5×0.8	16	3.5	3.9	—	T20	5.0	
	<b>STS1</b>	6.8	M3×0.5	7	2.2	2.8	90°	T10	2.5	

Z

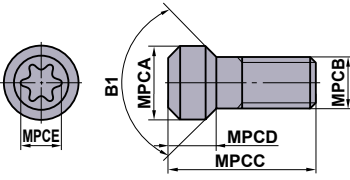
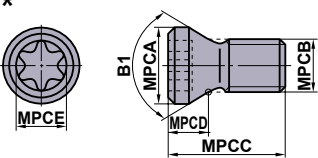
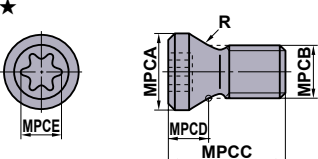
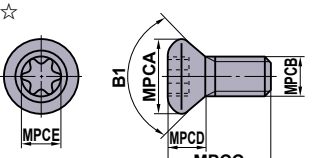
ERSATZTEILE

Geometrie	Bestell- bezeichnung	Abmessungen (mm)					Winkel B1	MPCDS	TQ (N·m)	Werkzeughalter
		MPCA	MPCB	MPCC	MPCD	MPCE				
	* <b>TS16</b>	2.5	M1.6×0.35	3.2	1.6	1.8	60°	T6	0.6	<b>MICRO-DEX</b> (☉E018)
	<b>TS2</b>	2.7	M2×0.4	4.6	1.4	1.8	60°	T6	0.6	
	* <b>TS2A</b>	2.7	M2×0.4	4.5	1.2	1.8	60°	T6	0.6	<b>AQX</b> (☉K172)
	<b>TS2C</b>	2.7	M2×0.4	3.8	1.4	1.8	60°	T6	0.6	
	☆ <b>TS2D</b>	3.8	M2×0.4	5.3	1.9	1.8	82°	T6	0.6	<b>DIMPLE BAR</b> (☉E007)
	<b>TS21</b>	2.7	M2×0.4	3.4	1.4	1.8	60°	T6	0.6	<b>F</b> Bohrstange (☉E029)
	* <b>TS22</b>	3.0	M2.2×0.45	5	1.2	1.8	60°	T6	0.6	<b>S</b> Bohrstange (☉E030)
	* <b>TS25</b>	3.3	M2.5×0.45	5.5	1.7	2.4	60°	T8	1.0	<b>AQX</b> (☉K172) <b>AJX</b> (☉K180)
	☆ <b>TS25D</b>	4.4	M2.5×0.45	6.2	2.2	2.4	82°	T8	1.0	<b>MMTI</b> Bohrstange (☉G026)
	* <b>TS25H</b>	3.6	M2.5×0.45	5.5	2	2.4	60°	T8	1.0	<b>SRM2</b> (☉K220)
	<b>TS202</b>	2.7	M2×0.4	5.5	1.8	1.8	60°	T6	0.6	
	<b>TS253</b>	3.3	M2.5×0.45	4.5	1.7	2.4	60°	T8	1.0	<b>Fräswerkzeug-Serien</b> (☉K001)
	<b>TS254</b>	3.3	M2.5×0.45	7	1.7	2.4	60°	T8	1.0	<b>SMALL TOOLS</b> (☉D001) <b>PMF</b> (☉K234)
	* <b>TS255</b>	3.5	M2.5×0.45	7.5	1.6	2.4	60°	T8	1.0	<b>Profil Halter</b> (☉C032)
	<b>TS3</b>	3.9	M3×0.5	6	2	2.4	60°	T8	1.0	<b>TSMP</b> (☉K232)
	<b>TS304</b>	3.9	M3×0.5	10.5	2.0	2.4	60°	T8	1.5	
	<b>TS3D</b>	5.0	M3×0.5	6	2.3	2.8	82°	T10	2.5	<b>DIMPLE BAR</b> (☉E007)
	* <b>TS3SB</b>	4.4	M3×0.5	8	2	2.4	80°	T8	1.5	<b>AXD4000</b> (☉K155)
	<b>TS3SBS</b>	4.4	M3×0.5	6.5	2	2.4	80°	T8	1.5	<b>AXD4000</b> (☉K155)
	☆ <b>TS31D</b>	4.8	M3×0.5	7.2	2.2	2.8	82°	T10	2.5	<b>DIMPLE BAR</b> (☉E007)
	* <b>TS32</b>	3.9	M3×0.5	7.5	2	2.4	60°	T8	2.0	<b>SRM2</b> (☉K220)
	* <b>TS33</b>	3.9	M3×0.5	6.7	2	2.4	60°	T8	1.5	<b>AQX</b> (☉K172) <b>AJX</b> (☉K180)
	<b>TS35</b>	4.8	M3.5×0.6	6.5	2.4	2.8	60°	T10	2.5	
	* <b>TS35D</b>	5.3	M3.5×0.6	12	2.8	3.4	60°	T15	3.5	<b>HSK System</b> (☉H001)
	★ <b>TS35R</b>	5.7	M3.5×0.6	10	2.1	3.4	—	T15	3.5	<b>AHX440S</b> (☉K034) <b>AHX475S</b> (☉K038)
	<b>TS351</b>	4.8	M3.5×0.6	7.2	2.4	2.8	60°	T10	2.5	<b>AJX</b> (☉K180) <b>SRM2</b> (☉K220)
	<b>TS352</b>	4.8	M3.5×0.6	10	3	2.8	60°	T10	2.5	<b>VFX5</b> (☉K192)
	* <b>TS4S</b>	5.4	M4×0.7	7	2.4	3.4	80°	T15	3.5	
	* <b>TS4SL</b>	5.4	M4×0.7	8	2.4	3.4	80°	T15	4.0	
	* <b>TS4SB</b>	5.8	M4×0.7	9	2.7	3.4	80°	T15	3.5	<b>AXD7000</b> (☉K166)
	* <b>TS4SBL</b>	5.8	M4×0.7	10.5	2.7	3.4	80°	T15	3.5	<b>GY Serie</b> (☉F004) <b>AXD7000</b> (☉K166)
	<b>TS4</b>	5.4	M4×0.7	8	2.6	3.4	60°	T15	3.5	<b>CE/CF/CGSP</b> (☉K230) <b>TSMP</b> (☉K232)
	<b>TS4D</b>	5.6	M4×0.7	7.7	2.5	3.4	82°	T15	3.5	<b>DIMPLE BAR</b> (☉E007)
	<b>TS42</b>	5.4	M4×0.7	6	2.6	3.4	60°	T15	3.5	
	<b>TS43</b>	5.4	M4×0.7	10	2.6	3.4	60°	T15	3.5	<b>AJX</b> (☉K180) <b>BRP</b> (☉K190) <b>SRM2</b> (☉K220)
	<b>TS44</b>	5.4	M4×0.7	12	2.6	3.4	60°	T15	3.5	
	<b>TS406</b>	5.4	M4×0.7	15.5	2.6	3.4	60°	T15	3.5	
	<b>TS407</b>	5.4	M4×0.7	9	2.6	3.4	60°	T15	3.5	<b>AQX</b> (☉K172) <b>AJX</b> (☉K180)
	<b>TS450</b>	5.9	M4.5×0.75	13	3.6	3.9	60°	T20	5.0	<b>VFX6</b> (☉K196)
	<b>TS5S</b>	6.8	M5×0.8	9	2.9	4.5	80°	T25	7.5	
	* <b>TS5SL</b>	6.8	M5×0.8	12	2.9	4.5	80°	T25	7.5	
	<b>TS5</b>	6.8	M5×0.8	9	3.2	4.5	60°	T25	7.5	<b>SP Halter</b> (☉C024) <b>CE/CF/CGSP</b> (☉K230) <b>TSMP</b> (☉K232)
	<b>TS5L</b>	6.8	M5×0.8	15	2.9	4.5	80°	T25	7.5	
	★ <b>TS5R</b>	6.9	M5×0.8	12	3.5	3.9	—	T20	5.0	<b>WWX400</b> (☉K056) <b>WJX</b> (☉K072)
	<b>TS52</b>	6.8	M5×0.8	8	3.2	4.5	60°	T25	7.5	<b>CE/CF/CGSP</b> (☉K230)
	<b>TS53</b>	6.8	M5×0.8	16	3.2	4.5	60°	T25	7.5	
	<b>TS54</b>	6.8	M5×0.8	12	3.2	4.5	60°	T25	7.5	<b>AJX</b> (☉K180)
	<b>TS55</b>	6.8	M5×0.8	10.5	3.2	4.5	60°	T25	7.5	<b>GY Serie</b> (☉F004) <b>AQX</b> (☉K172) <b>SPX</b> (☉K203) <b>SRM2</b> (☉K220)
	* <b>TS6S</b>	8.5	M6×1.0	13	4.4	5.6	60°	T30	10.0	<b>AQX</b> (☉K172) <b>SRM2</b> (☉K220)
	* <b>TS6</b>	8.5	M6×1.0	16	4.4	5.6	60°	T30	10.0	<b>SRM2</b> (☉K220)

N

ERSATZTEILE

# ERSATZTEILE

## KLEMMSCHRAUBEN

Geometrie	Bestell- bezeichnung	Abmessungen (mm)					Winkel B1	MPCDS	TQ (N·m)	Werkzeughalter
		MPCA	MPCB	MPCD	MPCD	MPCD				
	<b>TPS20</b>	2.7	M2×0.4	3.5	1.3	1.8	60°	6IP	0.5	
	<b>TPS20-1</b>	2.65	M2×0.4	4.7	2.4	1.8	60°	6IP	0.6	<b>MVX</b> (⊕M160)
	<b>TPS22</b>	3.0	M2.2×0.45	4.7	1.6	2.1	60°	7IP	0.5	
	<b>TPS22S</b>	3.0	M2.2×0.45	4.2	1.6	2.1	60°	7IP	0.5	
	<b>TPS25</b>	3.3	M2.5×0.45	5.5	1.7	2.1	60°	7IP	1.0	<b>APX3000</b> (⊕K133) <b>MVX</b> (⊕M160)
	<b>TPS25-1</b>	3.3	M2.5×0.45	6.5	1.7	2.1	60°	7IP	1.0	<b>APX3000</b> (⊕K133)
	<b>TPS27F1</b>	3.7	M2.7×0.35	6.5	1.8	2.1	60°	7IP	1.0	<b>VPX200</b> (⊕K086)
	<b>TPS27F2</b>	3.7	M2.7×0.35	8.0	1.8	2.1	60°	7IP	1.0	<b>VPX300</b> (⊕K100)
	<b>TPS3</b>	3.9	M3×0.5	6.7	1.4	2.82	60°	10IP	1.0	<b>MVX</b> (⊕M160)
	<b>* TPS3R</b>	4.6	M3×0.5	8.5	1.4	2.82	—	10IP	2.0	<b>WJX09</b> (⊕K072)
	<b>TPS3SB</b>	4.4	M3×0.5	8	2.0	2.82	80°	10IP	3.0	<b>AXD4000A</b> (⊕K162)
	<b>TPS35</b>	5.3	M3.5×0.6	11.5	2.8	3.4	60°	15IP	3.5	<b>ASX445</b> (⊕K026) <b>ASX400</b> (⊕K068) <b>PMR</b> (⊕K236)
	<b>TPS351</b>	4.8	M3.5×0.6	7.2	1.4	2.82	60°	10IP	2.5	<b>MVX</b> (⊕M160)
	<b>TPS351B</b>	5.1	M3.5×0.6	7.2	1.4	2.82	60°	10IP	2.5	<b>ARP</b> (⊕K238)
	<b>TPS4</b>	5.3	M4×0.7	8	2.6	3.4	60°	15IP	3.5	<b>APX4000</b> (⊕K140) <b>ARP</b> (⊕K238) <b>MVX</b> (⊕M160)
	<b>TPS40F1</b>	5.3	M4×0.5	10.5	2.8	3.4	60°	15IP	3.0	<b>VPX300</b> (⊕K100)
	<b>TPS43</b>	5.3	M4×0.7	10	2.6	3.4	60°	15IP	4.0	<b>APX4000</b> (⊕K140) <b>MVX</b> (⊕M160)
<b>* TPS4R</b>	6.4	M4×0.7	10.6	2.9	3.4	—	15IP	3.5	<b>WSX445</b> (⊕K016)	
<b>TPS54</b>	6.8	M5×0.8	12	3.2	4.5	60°	25IP	7.5	<b>MVX</b> (⊕M160)	
	<b>TSR05008S</b>	3.5	M5×0.8	8	—	2.8	—	T10	—	
	<b>TSR06011S</b>	4	M6×1.0	11	—	3.9	—	T20	—	
	<b>TSS04005</b>	—	M4×0.7	5	—	2.4	—	T8	—	<b>PMF</b> (⊕K234)
	<b>TSS04505S</b>	—	M4.5×0.7	5	—	3.5	—	T10	3.5	<b>FMAX</b> (⊕K051)
	<b>TSS05006</b>	—	M5×0.8	6	—	2.8	—	T10	—	
	<b>TSS06010</b>	—	M6×1	10	—	3.9	—	T20	—	
	<b>WCS503507H</b>	6.3	M5×0.5	7	3.3	3.5	—	—	5.0	<b>ASX445</b> (⊕K026) <b>ASX400</b> (⊕K068) <b>PMR</b> (⊕K236)
	<b>WCS604010H</b>	7.8	M6×0.75	10	4.1	4.0	—	—	7.0	<b>PMR</b> (⊕K236)
	<b>WS203107TPS</b>	3.1	M2×0.25	7.3	1.7	1.8	60°	6IP	1.0	<b>STAW</b> (⊕M141)
	<b>WS203108TPS</b>	3.1	M2×0.25	8.3	1.9	1.8	60°	6IP	1.0	
	<b>WS253909TPS</b>	3.9	M2.5×0.35	9.5	2.4	2.4	60°	8IP	2.0	
	<b>WS304912TPS</b>	4.9	M3×0.35	12	3.25	2.82	60°	10IP	2.5	
	<b>WS254012T</b>	4	M2.5×0.45	11.5	2.2	2.4	80°	T8	2.0	<b>TAW</b> (⊕M150)
	<b>WS254013T</b>	4	M2.5×0.45	12.5	2.2	2.4	80°	T8	2.0	
	<b>WS254014T</b>	4	M2.5×0.45	13.5	2.2	2.4	80°	T8	2.0	
	<b>WS254015T</b>	4	M2.5×0.45	14.5	2.2	2.4	80°	T8	2.0	
	<b>WS254016T</b>	4	M2.5×0.45	15.5	2.2	2.4	80°	T8	2.0	
	<b>WS304517T</b>	4.5	M3×0.5	16.5	3.4	2.8	60°	T10	3.5	
	<b>WS304518T</b>	4.5	M3×0.5	17.5	3.4	2.8	60°	T10	3.5	
	<b>WS355520T</b>	5.5	M3.5×0.6	19.5	3.9	3.4	60°	T15	5.5	
	<b>WS355521T</b>	5.5	M3.5×0.6	20.5	3.9	3.4	60°	T15	5.5	
	<b>WS406023T</b>	6	M4×0.7	22.0	4.4	4.5	60°	T25	8.5	
	<b>WS406024T</b>	6	M4×0.7	23.0	4.4	4.5	60°	T25	8.5	
	<b>WS508026T</b>	8	M5×0.8	25.0	5.2	5.1	60°	T27	12.0	
	<b>WS508027T</b>	8	M5×0.8	26.0	5.2	5.1	60°	T27	12.0	

# SCHRAUBE

Geometrie	Bestell- bezeichnung	Abmessungen (mm)					Winkel B1	MPCDS	TQ (N·m)	Werkzeughalter
		MPCA	MPCB	MPCC	MPCD	MPCE				
	<b>BOES101</b>	15	M10×1.5	45	10	8	60°	—	10.0	
	* <b>HSC08025H</b>	13	M8×1.25	33	8	5	—	—	24	VPX200/300 (⊕K086,K100) ARP (⊕K238)
	<b>HSC05030</b>	8.5	M5×0.8	35	5	4	—	—	10	APX3000/4000 (⊕K133,K140)
	* <b>HSC08030H</b>	13	M8×1.25	38	8	5	—	—	24	WSX445 (⊕K016)
	<b>HSC08045</b>	13	M8×1.25	53	8	5	—	—	24	VPX200/300 (⊕K086,K100)
	<b>HSC08040</b>	13	M8×1.25	48	8	5	—	—	24	WSX445 (⊕K016)
	<b>HSC08050</b>	13	M8×1.25	58	8	5	—	—	24	VPX200/300 (⊕K086,K100)
	* <b>HSC10030H</b>	16	M10×1.5	40	10	6	—	—	40	APX3000/4000 (⊕K133,K140) AJX (⊕K180) WSX445 (⊕K016)
	<b>HSC10035</b>	16	M10×1.5	45	10	6	—	—	44	VFX5 (⊕K192) VFX6 (⊕K196)
	<b>HSC10050</b>	16	M10×1.5	60	10	8	—	—	44	APX3000/4000 (⊕K133,K140) VPX200/300 (⊕K086,K100)
	<b>HSC10055</b>	16	M10×1.5	65	10	8	—	—	44	VFX5 (⊕K192)
	<b>HSC10060</b>	16	M10×1.5	70	10	8	—	—	44	VPX200/300 (⊕K086,K100)
	<b>HSC10070</b>	16	M10×1.5	80	10	8	—	—	44	VPX200/300 (⊕K086,K100) ASPX (⊕K028)
	<b>HSC12035</b>	18	M12×1.75	47	12	10	—	—	80	WSX445 (⊕K016)
	* <b>HSC12035H</b>	18	M12×1.75	47	12	10	—	—	80	APX3000/4000 (⊕K133,K140) AJX (⊕K180)
	<b>HSC12040</b>	18	M12×1.75	52	12	10	—	—	80	
	<b>HSC12045</b>	18	M12×1.75	57	12	10	—	—	80	WSX445 (⊕K016)
	<b>HSC12060</b>	18	M12×1.75	72	12	10	—	—	80	VPX200/300 (⊕K086,K100)
	<b>HSC12070</b>	18	M12×1.75	82	12	10	—	—	80	APX3000/4000 (⊕K133,K140) AJX (⊕K180) WSX445 (⊕K016)
	<b>HSC16040</b>	24	M16×2	56	16	14	—	—	150	WSX445 (⊕K016)
	* <b>HSC16040H</b>	24	M16×2	56	16	14	—	—	150	APX3000/4000 (⊕K133,K140) AJX (⊕K180)
<b>HSC16055</b>	24	M16×2	71	16	14	—	—	150	VPX200/300 (⊕K086,K100)	
<b>HSC16065</b>	24	M16×2	81	16	14	—	—	150	VPX200/300 (⊕K086,K100)	
<b>HSC16080</b>	24	M16×2	96	16	14	—	—	150		
<b>HSC20040</b>	30	M20×2.5	60	20	17	—	—	320		
<b>HSC20090</b>	30	M20×2.5	110	20	17	—	—	320		
	<b>HSCX12030H</b>	24	M12×1.75	37	7	8	—	—	40	FMAX (⊕K051)
	<b>HSCX16035H</b>	30	M16×2	44	9	12	—	—	100	
	<b>HSCX20035H</b>	36	M20×2.5	46	11	14	—	—	180	
	<b>HFF08033H</b>	11	M8×1.25	33	5	5	90°	—	8.2	WJX09 (⊕K072)
	<b>HFF08043H</b>	11	M8×1.25	43	5	5	90°	—	8.2	AXD4000 (⊕K155)
	<b>MBA16033H</b>	40	M16×2	43	10	14	—	—	150	AHX640 (für φ100) (⊕K041) WSX445 (⊕K016)
	<b>MBA20040H</b>	50	M20×2.5	54	14	17	—	—	320	APX4000 (⊕K140) AHX475S (⊕K038) AHX640S (⊕K041) AXD4000 (⊕K155) AXD7000 (⊕K166) AJX (⊕K180)

\* Mit Kühlmittelbohrung

**N**

ERSATZTEILE

Geometrie	Bestell- bezeichnung	Abmessungen (mm)						TQ (N·m)	Werkzeughalter
		MPCA	MPCB	MPCC	MPCD	MPCE	MPCF		
	<b>HDS08030</b>	M8×0.75	M8×1.25	30	13.5	11.5	4	8.2	BRP (⊕K190)
	<b>HDS10031</b>	M10×1.0	M10×1.5	31	14	12	5	9.0	PMF (⊕K234)

# ERSATZTEILE

## Große Einstellschraube

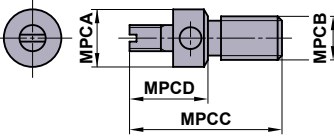
Geometrie	Bestellbezeichnung	Abmessungen (mm)					Winkel	MPCDS	TQ (N·m)	Werkzeughalter
		MPCA	MPCB	MPCC	MPCD	MPCE	B1			
	<b>KSS2</b>	6.6	M5×0.8	17.5	9	—	—	—	<b>FMAX</b> (K051)	

## Präzisions-Stellmutter

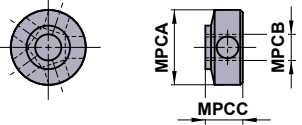
Geometrie	Bestellbezeichnung	Abmessungen (mm)					Winkel	MPCDS	TQ (N·m)	Werkzeughalter
		MPCA	MPCB	MPCC	MPCD	MPCE	B1			
	<b>KSN3</b>	8.6	M3×0.35	4.3	—	—	—	—	<b>FMAX</b> (K051)	



# UNTERLEGPLATTE

Geometrie	Bestell- bezeichnung	Abmessungen (mm)						Werkzeughalter
		MPCA	MPCB	MPCC	MPCD	MPCE	MPCF	
	CS32	9.52	3.18	0.8	0.8	1.2	1.2	
	CS42	12.70	3.18	0.8	0.8	1.2	1.6	
	CS43	12.70	4.76	0.8	0.8	1.2	1.6	
	* PS31	8.28	2.38	0.2	0.2	0.6	0.6	
	* PS42	11.46	3.18	0.2	0.2	0.6	1.0	
	CT22	6.35	3.18	0.4	0.8	1.2	—	F Bohrstange (⊕E028)
	CT32	9.52	3.18	0.4	0.8	1.2	—	
	* PT21	5.11	2.38	0.2	0.2	0.6	—	
	* PT32	8.28	3.18	0.2	0.2	0.6	—	
	* PT42	10.85	3.18	0.3	0.3	0.7	—	
	DCSVN32	9.52	3.18	0.8	1.2	—	—	DOPPELKLEMM Halter (⊕C019) DIMPLE BAR-BOHRSTANGE (⊕E017)
	ESS42	12.70	3.18	0.8	0.8	1.2	1.6	
	EST32	9.52	3.18	0.4	0.8	1.2	—	
	EST43	12.70	4.76	0.4	0.8	1.2	—	
	LLSCN3T3	9.52	3.97	0.4	0.4	0.8	0.8	LL Halter (⊕C008)
	LLSCN33	9.52	4.76	0.4	0.4	0.8	0.8	LL Halter (⊕C008)
	LLSCN42	12.70	3.18	0.8	0.8	1.2	1.2	DIMPLE BAR-BOHRSTANGE (⊕E015)
	LLSCN53	15.87	4.76	1.2	1.2	1.6	1.6	P Bohrstange (⊕E038)
	LLSCN63	19.05	4.76	1.2	1.2	1.6	1.6	HSK System (⊕H001)
	* LLSCP42	12.70	3.18	0.8	0.8	1.2	1.2	DIMPLE BAR-BOHRSTANGE (⊕E015)
	* LLSCP63	19.05	4.76	1.2	1.2	1.6	1.6	P Bohrstange (⊕E038)
								HSK System (⊕H001)
	LLSDN32	9.52	3.18	0.8	1.2	—	—	DOPPELKLEMM Halter (⊕C010)
	LLSDN42	12.70	3.18	0.8	1.2	—	—	LL Halter (⊕C010)
	LLSDN43	12.70	4.76	0.8	1.2	—	—	DIMPLE BAR-BOHRSTANGE (⊕E015)
	LLSDN53	15.87	4.76	1.2	1.6	—	—	P Bohrstange (⊕E038)
* LLSDP42	12.70	3.18	0.8	1.2	—	—	HSK System (⊕H001)	
	LLSRN103	8.3	3.18	—	—	—	—	LL Halter (⊕C026)
	LLSRN123	9.8	3.18	—	—	—	—	HSK System (⊕H001)
	LLSRN164	13.6	4.76	—	—	—	—	
	LLSRN204	17.3	4.76	—	—	—	—	
	LLSRN256	22.0	6.35	—	—	—	—	
	LLSRN326	28.0	6.35	—	—	—	—	
	LLSSN32	9.52	3.18	0.8	0.8	1.2	1.2	DIMPLE BAR-BOHRSTANGE (⊕E016) P Bohrstange (⊕E037)
	LLSSN33	9.52	4.76	0.8	0.8	1.2	1.2	
	LLSSN42	12.70	3.18	0.8	0.8	1.2	1.6	
	LLSSN53	15.87	4.76	1.2	1.2	1.6	1.6	
	LLSSN63	19.05	4.76	1.2	1.2	1.6	2.0	
	* LLSSP42	12.70	3.18	0.8	0.8	1.2	1.6	

N

ERSATZTEILE



# ERSATZTEILE

## UNTERLEGPLATTE

Geometrie	Bestell- bezeichnung	Abmessungen (mm)						Werkzeughalter
		MPCA	MPCB	MPCC	MPCD	MPCE	MPCF	
	LLSTE32	7.6	3.18	0.4	0.4	0.4	—	LL Halter (☉C016) DIMPLE BAR-BOHRSTANGE (☉E016) P Bohrstange (☉E037)
	LLSTN32	9.52	3.18	0.4	0.8	1.2	—	
	LLSTN33	9.52	4.76	0.4	0.8	1.2	—	
	LLSTN42	12.70	3.18	0.4	0.8	1.2	—	
	LLSTN53	15.87	4.76	0.8	1.2	1.6	—	
	* LLSTP32	9.52	3.18	0.4	0.8	1.2	—	
	* LLSTP42	12.70	3.18	0.4	0.8	1.2	—	
	LLSWN32	9.52	3.18	0.4	0.8	1.2	—	LL Halter (☉C022) DOPPELKLEMM Halter (☉C022) DIMPLE BAR-BOHRSTANGE (☉E017)
	LLSWN3T3	9.52	3.97	0.4	0.8	1.2	—	
	LLSWN42	12.70	3.18	0.4	0.8	1.2	—	
	* LLSWP32	9.52	3.18	0.4	0.8	1.2	—	
	* LLSWP42	12.70	3.18	0.4	0.8	1.2	—	
	MHS532R/L	9.4	15.7	4.5	0.8	0.8	—	
	MHS533R/L	9.4	15.7	4.5	1.2	1.2	—	
	MHS534R/L	9.4	15.7	4.5	1.6	1.6	—	
	MHS543R/L	9.4	15.7	6.5	1.2	1.2	—	
<p>Die Position der Bohrung liegt außerhalb der Mitte.</p>	MLCP42	12.58	3.18	1.2	1.2	1.2	1.2	P Bohrstange (☉E038)
<p>Die Position der Bohrung liegt außerhalb der Mitte.</p>	MLDP42	12.56	3.18	1.2	1.2	—	—	P Bohrstange (☉E038)
<p>Die Position der Bohrung liegt außerhalb der Mitte.</p>	MLSP42	12.63	3.18	1.2	1.2	1.2	1.2	P Bohrstange (☉E037)
<p>Die Position der Bohrung liegt außerhalb der Mitte.</p>	MLTP32	9.50	3.18	1.2	1.2	1.2	—	P Bohrstange (☉E037)
	MSCN63	18.8	4.76	1.6	1.6	1.6	1.6	DOPPELKLEMM Halter (☉C009) (für Schwerzerspannung)
	MSSN63	18.8	4.76	1.6	1.6	1.6	1.6	DOPPELKLEMM Halter (☉C012) (für Schwerzerspannung)
	CT32T1	9.525	15.03	3.18	—	—	—	
	* PT32T1R	8.28	13.34	3.18	—	—	—	
	* PT32T2R	8.28	13.19	3.18	—	—	—	

N

ERSATZTEILE

Geometrie	Bestell- bezeichnung	Abmessungen (mm)						Werkzeughalter
		MPCA	MPCB	MPCC	MPCD	MPCE	MPCF	
	<b>PV321</b>	9.52	3.18	0.4	0.4	—	—	<b>MP Halter</b> (C019)
	<b>PV322</b>	9.52	3.18	0.8	0.8	—	—	
	<b>PV323</b>	9.52	3.18	1.2	1.2	—	—	
	<b>SPSVN32</b>	8.06	3.18	0.3	0.3	—	—	<b>SP Halter</b> (C030) <b>HSK System</b> (H001)
	<b>STASX400N</b>	11.00	3.00	0.4	0.4	0.4	0.4	<b>ASX400</b> (K068)
	<b>STASX445N</b>	10.76	3.00	—	—	—	—	<b>ASX445</b> (K026)
	<b>STBS500N</b>	12.7	3.18	0.8	0.8	0.8	0.8	
	<b>WPSTN33</b>	9.3	4.76	0.8	0.4	1.2	—	<b>WP Halter</b> (C017)
	<b>WPSTN43</b>	12.50	4.76	0.8	0.4	1.2	—	
	* <b>WPSWC43</b>	12.50	4.76	0.4	0.8	1.2	—	<b>WP Halter</b> (C023)
	<b>WPSWN43</b>	12.50	4.76	0.4	0.8	1.2	—	
	<b>SPSTDN32</b>	8.687	3.175	—	—	—	—	

**Z**

ERSATZTEILE

# ERSATZTEILE

## BEFESTIGUNGSFEDER UND KNIEHEBEL

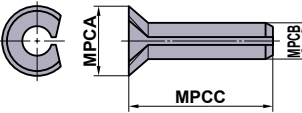
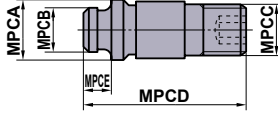
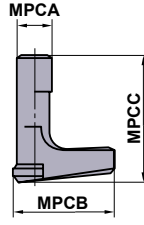
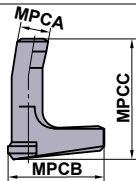
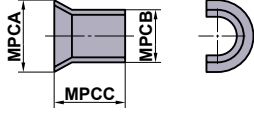
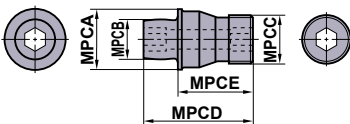
Geometrie	Bestell- bezeichnung	Abmessungen (mm)					Werkzeughalter
		MPCA	MPCB	MPCC	MPCD	MPCE	
	<b>BCP141</b>	3.0	1.4	5.6	—	—	<b>SP Halter</b> (☉C030) <b>F Bohrstange</b> (☉E028) <b>HSK System</b> (☉H013)
	<b>BCP201</b>	4.3	2	7.4	—	—	
	<b>BCP202</b>	4.3	2	6.4	—	—	
	<b>BCP251</b>	4.8	2.5	7.4	—	—	
	<b>BCP252</b>	4.8	2.5	6.4	—	—	
	<b>BCP301</b>	5.3	3	7.4	—	—	
	<b>CCP33</b>	6.5	3.66	M5×0.8	18.5	3	<b>WP Halter</b> (☉C017)
	<b>CCP34</b>	7.5	5.0	M6×1.0	18.5	3	
	<b>CCP44</b>	7.5	5.0	M5×0.8	14.2	3	
	<b>LLCL12S</b>	2.1	9.3	5.6	—	—	<b>LL Halter</b> (☉C016) <b>P Bohrstange</b> (☉E037) <b>HSK System</b> (☉H001)
	<b>LLCL13</b>	3.6	10	12.5	—	—	
	<b>LLCL13S</b>	3.6	10	7.8	—	—	
	<b>LLCL14</b>	4.7	13.4	13.2	—	—	
	<b>LLCL14S</b>	4.7	13.6	12.2	—	—	
	<b>LLCL15</b>	6.0	19	17	—	—	
	<b>LLCL16</b>	7.5	20.8	21	—	—	
	<b>LLCL18</b>	8.6	25.4	25.2	—	—	
	<b>LLCL23</b>	3.6	12.0	11.5	—	—	
	<b>LLCL23S</b>	3.6	11.6	9.5	—	—	
	<b>LLCL24</b>	4.7	16.2	14.8	—	—	
	<b>LLCL25</b>	6.0	17.1	17	—	—	
		<b>LLCL110</b>	3.0	10.7	11.6	—	
<b>LLCL112</b>		3.5	13	13.5	—	—	
<b>LLCL116</b>		4.5	18.5	18	—	—	
<b>LLCL120</b>		5.6	20.3	19	—	—	
<b>LLCL125</b>		6	24	24	—	—	
<b>LLCL132</b>		8	30	27	—	—	
	<b>LLP13</b>	5.55	4.85	5.3	—	—	<b>LL Halter</b> (☉C008) <b>DOPPELKLEMM Halter</b> (☉C008) <b>DIMPLE BAR-BOHRSTANGE</b> (☉E015) <b>P Bohrstange</b> (☉E037) <b>HSK System</b> (☉H001)
	<b>LLP14</b>	7.25	6.55	5.8	—	—	
	<b>LLP15</b>	8.8	8.05	8.6	—	—	
	<b>LLP16</b>	10.85	9.85	11.1	—	—	
	<b>LLP18</b>	15.35	13.05	12.0	—	—	
	<b>LLP23</b>	5.55	4.85	6.8	—	—	
	<b>LLP24</b>	7.25	6.55	9.1	—	—	
	<b>MP6</b>	11.9	7.8	M10×1	22.1	15	<b>DOPPELKLEMM Halter</b> (☉C009) (für Schwerzerspannung)

Z

ERSATZTEILE

## KNIEHEBEL

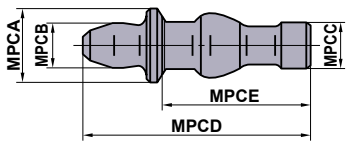
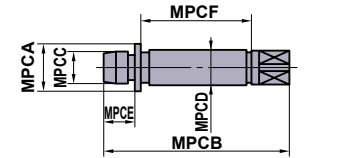
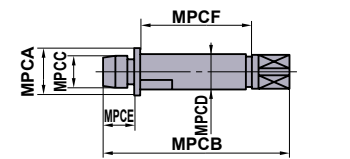
Geometrie	Bestell- bezeichnung	Abmessungen (mm)						Werkzeughalter
		MPCA	MPCB	MPCC	MPCD	MPCE	MPCF	
	<b>P11S</b>	6	3.7	4	17	11.1	—	MP Halter (C019)
	<b>P21S</b>	7.5	4.9	4.5	17.2	11.5	—	
	<b>P221US</b>	4	18	2.11	3.5	3.3	7.7	
	<b>P333WS</b>	5.75	24	3.64	5.0	4.9	11.3	
	<b>P434W</b>	7.75	30	5.03	7.0	4.9	16.8	

## SPANNPRATZE

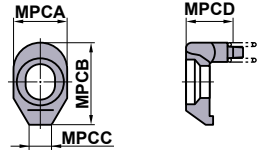
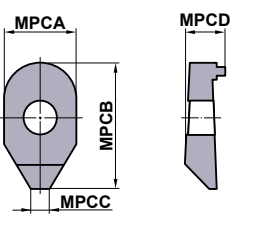
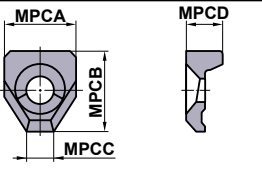
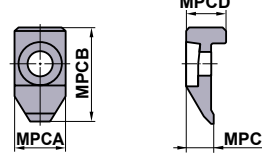
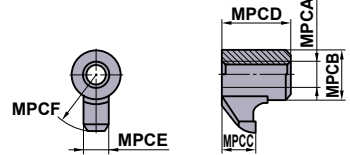
Geometrie	Bestell- bezeichnung	Abmessungen (mm)						Werkzeughalter
		MPCA	MPCB	MPCC	MPCD	MPCE	MPCF	
	<b>AMS3</b>	7	12	3	3.3	—	—	Profil Halter (C032) AJX (K180)
	<b>AMS4</b>	9	13.5	3	3.8	—	—	
	<b>AMS5</b>	10	15	3.5	5	—	—	
	<b>CA142</b>	8	15	4	7	—	—	
	<b>CA150</b>	9	16	4.5	7	—	—	
	<b>CA151</b>	10	17	5	7	—	—	
	<b>CA152</b>	10	19	5	7	—	—	
	<b>CA153</b>	10	24	5	7	—	—	
	<b>CA161</b>	13	20	6	8	—	—	
	<b>CA162</b>	13	24	6	8	—	—	
	<b>CA163</b>	13	27	6	8	—	—	
	<b>CCK13</b>	15	18.5	6	9	—	—	WP Halter (C017)
	<b>CCK14</b>	19	22	8	9.5	—	—	
	<b>CCTC1</b>	13	25	7	10.2	—	—	
	<b>CK231</b>	M6×1	8	4	7.5	4.5	9.5	
	<b>CK232</b>	M6×1	8	4.5	8	4.5	11.5	
	<b>CK341</b>	M8×1	11	5.5	13.5	6	13.5	
	<b>CK342</b>	M8×1	11	6	14	6	16.5	

N

ERSATZTEILE

# ERSATZTEILE

## SPANNPRATZE

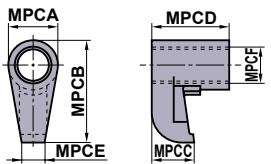
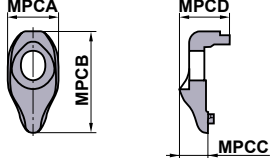
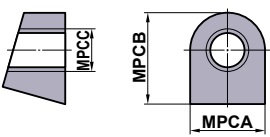
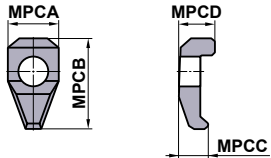
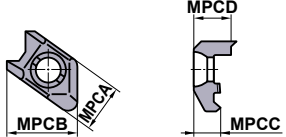
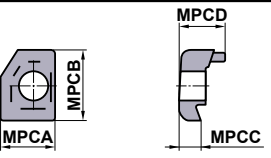
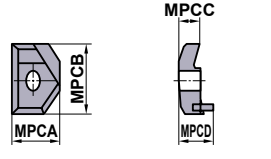
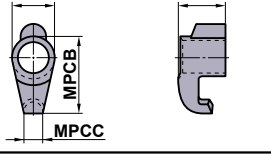
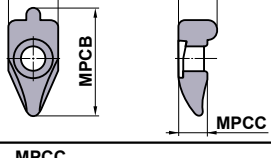
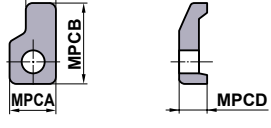
Geometrie	Bestell- bezeichnung	Abmessungen (mm)						Werkzeughalter
		MPCA	MPCB	MPCC	MPCD	MPCE	MPCF	
	<b>CKW6</b>	10.9	22.5	9.2	16.8	5	M8×1	<b>DOPPELKLEMM Halter</b> (⊕C009) (für Schwerzerspannung)
	<b>DCK2211</b> <b>DCK2613</b> <b>DCK3113</b>	11 13 13	22 26.5 31	6.57 7.35 9	11.1 12.9 14.5	— — —	— — —	<b>DOPPELKLEMM Halter</b> (⊕C008) <b>DIMPLE BAR-BOHRSTANGE</b> (⊕E015) <b>HSK System</b> (⊕H001)
	<b>KGC1</b>	12.0	15.0	M7×0.75	—	—	—	
	<b>LK1</b>	8	14.3	4.5	5.9	—	—	
	<b>MHK5NR/L</b>	15.5	23.5	8.1	12.1	—	—	
	<b>MTK1R/L</b>	13	17.5	5	12	—	—	<b>MG Halter</b> (⊕F124) <b>MT Halter</b> (⊕G024) <b>HSK System</b> (⊕H001)
	<b>MTK2R/L</b>	18	28	7	14	—	—	
	<b>SETK51</b> <b>SETK61</b>	6.8 8.9	14.5 18.1	2.9 4.1	8 8.6	— —	— —	<b>MMTE Halter</b> (⊕G019) <b>MMTI Halter</b> (⊕G026) <b>HSK System</b> (⊕H001)
	<b>SRK1R</b>	9.4	21	5.5	7.5	—	—	
	<b>UCR</b>	12	24	8	7	—	—	

## SPANBRECHER

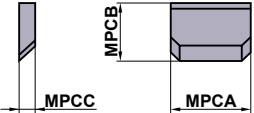
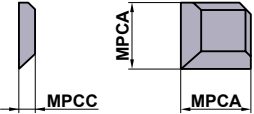
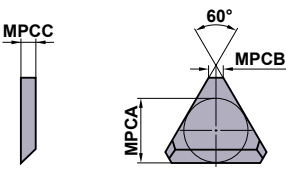
Geometrie	Bestell- bezeichnung	Abmessungen (mm)					Werkzeughalter
		MPCA	MPCB	MPCC	IC	LBB	
	<b>CBS3</b>	9.4	8.0	1.5	9.525	1.5	
	<b>CBS4</b>	12.6	9.2	2.5	12.70	3.5	
	<b>CBS4N</b>	12.6	10.2	2.5	12.70	2.5	
	<b>CBS4F</b>	12.6	11.2	2.5	12.70	1.5	
	<b>CBS6</b>	18.9	14.6	2.5	19.05	4.5	
	<b>CBS6F</b>	18.9	17.6	2.5	19.05	1.5	
	<b>CBS3D</b>	8.0	—	1.5	9.525	1.5	
	<b>CBS4D</b>	10.2	—	2.5	12.70	2.5	
	<b>CBT2N</b>	5.67	1.4	1.5	6.35	1.0	<b>F</b> Bohrstange (⊕E028) *Für positive WSP ist die Spanbrecherbreite 0.5mm größer als in der Liste angegeben.
	<b>CBT3</b>	7.20	1.4	2.5	9.525	3.5	
	<b>CBT3N</b>	7.87	1.4	2.5	9.525	2.5	
	<b>CBT3F</b>	8.53	1.4	2.5	9.525	1.5	
	<b>CBT4N</b>	11.07	1.4	2.5	12.70	2.5	
	<b>CBT4F</b>	11.73	1.4	2.5	12.70	1.5	

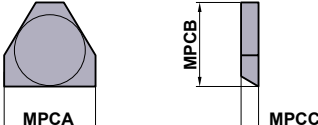
Geometrie	Bestell- bezeichnung	Abmessungen (mm)			MPCD (mm)	Werkzeughalter
		MPCA	MPCB	MPCC		
	<b>CBT3106</b>	11.5	10.6	2.0	2.5—3.0	
	<b>CBT3113</b>	11.5	11.3	2.0	1.5—2.0	
	<b>CBT3120</b>	11.5	12	2.0	0.75—1.25	

**Z**

ERSATZTEILE

# KUPFERPASTEN

## KUPFERPASTEN

Form	Bestellbezeichnung	Lager	Inhalt (g)
	MK1K	★	20
	MK1KS	★	3



# TECHNISCHE DATEN

ÜBEREINSTIMMUNG MIT ISO13399 .....	P002
STÖRUNGSBESEITIGUNG (DREHEN).....	P006
SPANKONTROLLE BEIM DREHEN .....	P008
AUSWIRKUNGEN VON SCHNITTPARAMETERN (DREHEN) .....	P009
FUNKTION DER WERKZEUGEIGENSCHAFTEN (DREHEN).....	P011
KALKULATIONSFORMELN (LEISTUNGS-AUFNAHME).....	P015
FEHLERBEHEBUNG BEI DER GEWINDEBEARBEITUNG.....	P016
GEWINDESCHNEIDMETHODE .....	P017
WERKSTOFFVERGLEICHSTABELLE .....	P020
OBERFLÄCHENRAUHIGKEIT.....	P024
HÄRTEVERGLEICHSTABELLE .....	P025
TOLERANZANGABEN FÜR INNENDURCHMESSER (BOHRUNG).....	P026
ISO-PASSUNGEN EINHEITSWELLE .....	P028
INTERNATIONAL EINHEITLICHES SYSTEM .....	P030
VERSCHLEISSARTEN.....	P031
SCHNEIDSTOFFSORTEN.....	P032
SORTEN ÜBERSICHT.....	P033
SORTEN VERGLEICHSTABELLE.....	P034
SPANBRECHER VERGLEICHSTABELLE .....	P040



# ÜBEREINSTIMMUNG MIT ISO13399

## Liste der Eigenschaften nach ISO13399

Alphabetisch

Quelle: Norm ISO13399

URL : <https://www.iso.org/search/x/query/13399>

ISO13399 Eigenschaften	Inhalte
<b>ADJLX</b>	Einstellgrenze maximal
<b>ADJRG</b>	Einstellbereich
<b>ALF</b>	Freiwinkel radial
<b>ALP</b>	Freiwinkel axial
<b>AN</b>	Hauptfreiwinkel
<b>ANN</b>	Hauptfreiwinkel
<b>APMX</b>	Max. Schnitttiefe
<b>AS</b>	Freiwinkel Wiper-Schneide
<b>ASP</b>	Überstand Justierschraube
<b>AZ</b>	Max. Eintauchtiefe
<b>B</b>	Schaftbreite
<b>BBD</b>	Konstruktiv gewuchtete Ausführung
<b>BCH</b>	Fasenlänge Radius
<b>BD</b>	Körperdurchmesser
<b>BDX</b>	Max. Körperdurchmesser
<b>BHCC</b>	Lochkreiszahl
<b>BHTA</b>	Halber Kegeleinstellwinkel
<b>BMC</b>	Bezeichnung Gehäusewerkstoff
<b>BS</b>	Planschneidenbreite
<b>BSR</b>	Wiper-Schneidkantenradius
<b>CASC</b>	Bezeichnung Einsatzgröße
<b>CB</b>	Anzahl der Spanbrecherflächen
<b>CBDP</b>	Anschluss Bohrungstiefe
<b>CBMD</b>	Spanbrecher Herstellerbezeichnung
<b>CBP</b>	Eigenschaft Spanbrecher
<b>CCMS</b>	Anschlusscode maschinenseitig
<b>CCWS</b>	Anschlusscode werkstückseitig
<b>CCP</b>	Eigenschaft Eckfase
<b>CDI</b>	WSP-Schnittdurchmesser
<b>CDX</b>	Max. Stechtiefe
<b>CEATC</b>	Code Winkeltyp Schneidkante
<b>CECC</b>	Code Schneidkantenzustand
<b>CEDC</b>	Anzahl Schneiden
<b>CF</b>	Punktfase
<b>CHW</b>	Eckfasenbreite
<b>CICT</b>	Anzahl Schneidteile
<b>CNC</b>	Anzahl Ecken
<b>CND</b>	Kühlschmierstoffeintritt, Durchmesser
<b>CNSC</b>	Kühlschmierstoffeintritt
<b>CNT</b>	Kühlschmierstoffeintritt, Gewindegröße
<b>CP</b>	Kühlmitteldruck
<b>CRE</b>	Punktradius
<b>CRKS</b>	Gewindegröße des Anzugsbolzens
<b>CSP</b>	Eigenschaft Kühlmittelzufuhr
<b>CTP</b>	Eigenschaft Beschichtung
<b>CTX</b>	Schnittpunktübertragung X-Richtung
<b>CTY</b>	Schnittpunktübertragung Y-Richtung
<b>CUTDIA</b>	Maximaler Werkstückdurchmesser für das Abstechen
<b>CUB</b>	Anschlusseinheit Basis
<b>CW</b>	Stechbreite
<b>CWX</b>	Max. Stechbreite
<b>CXD</b>	Durchmesser Kühlmittelauslass

ISO13399 Eigenschaften	Inhalte
<b>CXSC</b>	Kühlschmierstoffaustritt
<b>CZC</b>	Aufnahmegröße
<b>D1</b>	Durchmesser Befestigungsbohrung
<b>DAH</b>	Durchmesser Zugangsbohrung
<b>DAXN</b>	Min. axialer Stechdurchmesser
<b>DAXX</b>	Max. axialer Stechdurchmesser
<b>DBC</b>	Durchmesser Lochkreis
<b>DC</b>	Schnittdurchmesser
<b>DCB</b>	Spanndurchmesser, nominal, werkstückseitig
<b>DCBN</b>	Spanndurchmesser, min.
<b>DCBX</b>	Spanndurchmesser, max.
<b>DCC</b>	Design-Konfigurationscode
<b>DCCB</b>	Senkbohrung Durchmesser Anschlussbohrung
<b>DCIN</b>	Schnittdurchmesser intern
<b>DCINN</b>	Schnittdurchmesser intern minimal
<b>DCINX</b>	Schnittdurchmesser intern maximal
<b>DCN</b>	Min. Schneiddurchmesser
<b>DCON</b>	Aufnahmedurchmesser, werkstückseitig
<b>DCONMS</b>	Aufnahmedurchmesser maschinenseitig
<b>DCONWS</b>	Aufnahmedurchmesser werkstückseitig
<b>DCSC</b>	Code Schnittdurchmessergröße
<b>DCSFMS</b>	Durchmesser Plananlage maschinenseitig
<b>DCX</b>	Max. Schneiddurchmesser
<b>DF</b>	Flanschdurchmesser
<b>DHUB</b>	Nabendurchmesser
<b>DMIN</b>	Bohrungsdurchmesser, min.
<b>DMM</b>	Schaftdurchmesser
<b>DN</b>	Durchmesser des Freistichs
<b>DRVA</b>	Antriebswinkel
<b>EPSR</b>	Wendeplatten Winkel
<b>FHA</b>	Drallwinkel
<b>FHCSA</b>	Winkel der Senkung der Befestigungsbohrung
<b>FHCSD</b>	Befestigungsloch Senkdurchmesser
<b>FLGT</b>	Flanschdicke
<b>FMT</b>	Gewindeart
<b>FXHLP</b>	Eigenschaft Befestigungsloch
<b>GAMF</b>	Spanwinkel radial
<b>GAMN</b>	Spanwinkel normal
<b>GAMO</b>	Spanwinkel orthogonal
<b>GAMP</b>	Spanwinkel axial
<b>GAN</b>	Spanwinkel
<b>H</b>	Schafthöhe
<b>HA</b>	Gewindehöhe theoretisch
<b>HAND</b>	Richtung
<b>HBH</b>	Kopf Boden Versatzhöhe
<b>HBKL</b>	Kopf Rückseite Versatzlänge
<b>HBKW</b>	Kopf Rückseite Versatzbreite
<b>HBL</b>	Kopf Boden Versatzlänge
<b>HC</b>	Gewindehöhe tatsächlich
<b>HF</b>	Funktionshöhe
<b>HHUB</b>	Nabenhöhe
<b>HTB</b>	Körperhöhe
<b>IC</b>	Einbeschriebener Kreis
<b>IFS</b>	Code WSP-Montageart
<b>IIC</b>	Code WSP-Schnittstelle
<b>INSL</b>	Schneidkantenlänge
<b>KAPR</b>	Einstellwinkel
<b>KCH</b>	Eckfasenwinkel

# TECHNISCHE DATEN

ISO13399 Eigenschaften	Inhalte
<b>KRINS</b>	Winkel der Hauptschneide
<b>KWW</b>	Keilnutbreite
<b>KYP</b>	Eigenschaft der Mitnehmernut
<b>L</b>	Nutzlänge
<b>LAMS</b>	Neigungswinkel
<b>LB</b>	Körperlänge
<b>LBB</b>	Breite Spanbrecher
<b>LBX</b>	Max. Körperlänge
<b>LCCB</b>	Senkbohrung Tiefe Anschlussbohrung
<b>LCF</b>	Spannutlänge
<b>LDRED</b>	Reduzierte Länge Körperdurchmesser
<b>LE</b>	Effektive Länge Schneidkante
<b>LF</b>	Funktionslänge
<b>LFA</b>	Eine Abmessung der Funktionslänge
<b>LH</b>	Kopflänge
<b>LPR</b>	Überstehende Länge
<b>LS</b>	Schaftlänge
<b>LSC</b>	Einspannlänge
<b>LSCN</b>	Min. Einspannlänge
<b>LSCX</b>	Max. Einspannlänge
<b>LTA</b>	LTA-Länge (Länge von MCS zu CRP)
<b>LU</b>	Nutzlänge
<b>LUX</b>	Max. Nutzlänge
<b>M</b>	M-Maß
<b>M2</b>	Abstand zwischen Innenkreisdurchmesser und der Ecke einer Schneidplatte mit sekundärer Winkelangabe
<b>MHA</b>	Winkel Montagebohrung
<b>MHD</b>	Abstand Montageloch
<b>MHH</b>	Höhe Montageloch
<b>MIID</b>	Bezeichnung Schneidplatte
<b>MTP</b>	Code Auflageart
<b>NCE</b>	Anzahl Schnittenden
<b>NOF</b>	Anzahl Schneiden
<b>NOI</b>	Anzahl WSP-Index
<b>NT</b>	Anzahl Zähne
<b>OAH</b>	Gesamthöhe
<b>OAL</b>	Gesamtlänge
<b>OAW</b>	Gesamtbreite
<b>PDPT</b>	Profiltiefe WSP
<b>PDX</b>	Profilabstand ex
<b>PDY</b>	Profilabstand ey
<b>PFS</b>	Code Profilart
<b>PL</b>	Abstand
<b>PNA</b>	Winkelprofil
<b>PRFRAD</b>	Profilradius
<b>PSIR</b>	Hauptschneidenwinkel
<b>PSIRL</b>	Winkel der Hauptschneide Linksausführung
<b>PSIRR</b>	Winkel der Hauptschneide Rechtsausführung
<b>RAL</b>	Freiwinkel Linksausführung
<b>RAR</b>	Freiwinkel Rechtsausführung
<b>RCP</b>	Eigenschaft abgerundete Ecke
<b>RE</b>	Eckenradius
<b>REL</b>	Eckenradius Linksausführung
<b>RER</b>	Eckenradius Rechtsausführung
<b>RMPX</b>	Max. Eintauchwinkel
<b>RPMX</b>	Max. Drehzahl
<b>S</b>	WSP-Stärke
<b>S1</b>	Schneidplattendicke
<b>SC</b>	Schneidplattendicke gesamt
<b>SDL</b>	Stufenlänge
<b>SIG</b>	Spitzenwinkel

ISO13399 Eigenschaften	Inhalte
<b>SSC</b>	Code Plattensitzgröße
<b>SX</b>	Code Querschnittsform des Schafts
<b>TC</b>	WSP Toleranzklasse
<b>TCE</b>	Code bestückte Schneidkante
<b>TCTR</b>	Gewindetoleranzklasse
<b>TD</b>	Gewindenenddurchmesser, metrisch
<b>THFT</b>	Gewindeart
<b>THL</b>	Länge Gewindedrehen
<b>THLGTH</b>	Gewindelänge
<b>THSC</b>	Code Werkzeughalterform
<b>THUB</b>	Nabendicke
<b>TP</b>	Gewindesteigung
<b>TPI</b>	Gewindegänge je Inch
<b>TPIN</b>	Gewindegänge je Inch min.
<b>TPIX</b>	Gewindegänge je Inch max.
<b>TPN</b>	Min. Gewindesteigung
<b>TPT</b>	Gewindeprofiltyp
<b>TPX</b>	Max. Gewindesteigung
<b>TQ</b>	Drehmoment
<b>TSYC</b>	Code für Werkzeugtyp
<b>TTP</b>	Gewindeform
<b>ULDR</b>	Verhältnis Nutzlänge/Durchmesser
<b>UST</b>	Einheitssystem
<b>W1</b>	Breite der Wendeplatte
<b>WEP</b>	Eigenschaft Wiper-Kante
<b>WF</b>	Funktionsbreite
<b>WF2</b>	Abstand zwischen Schnittpunkt der Schneide und des Plattensitzes am Drehhalter
<b>WFS</b>	Funktionsbreite sekundär
<b>WT</b>	Masse
<b>ZEFF</b>	Anzahl wirksamer Schneiden, stirnseitig
<b>ZEPF</b>	Anzahl wirksamer Schneiden, umfangseitig
<b>ZNC</b>	Anzahl Schneidkantenzentren
<b>ZNF</b>	Anzahl stirnseitig montierte WSP
<b>ZNP</b>	Anzahl peripher montierte WSP

## Liste der Referenzsymbole nach ISO13399

ISO13399 Referenzsymbole	Inhalte
<b>CIP</b>	Koordinatensystem in der Bearbeitung
<b>CRP</b>	Schnittreferenzpunkt
<b>CSW</b>	Koordinatensystem werkstückseitig
<b>MCS</b>	Befestigungskoordinatensystem
<b>PCS</b>	Primäres Koordinatensystem

# STÖRUNGSBESEITIGUNG (DREHEN)

Lösung		WSP-Sortenauswahl				Schnittbedingungen				Art und Design				Maschine Einbau des Werkzeugs								
		Wählen Sie eine härtere Sorte	Wählen Sie eine zähere Sorte	Wählen Sie eine hitzebeständige Sorte	Wählen Sie eine adhäsionsbeständige Sorte	Schnittgeschwindigkeit		Vorschub	Schnitttiefe	Kühlung		Spanbrecherwahl	Freiwinkel	Eckenradius	Anstellwinkel	Fase verstärkt die Schneidkanten	WSP - Toleranz	Verbesserte Werkzeughalter-Stabilität	Werkzeug- und Werkstückspannung erhöhen	Halteauskrantung reduzieren	Leistung und Maschinenspiel verringern	
						Höher ↗	Niedriger ↘			Kein Kühlschmiermittel	Festlegen ob mit oder ohne Kühlschmiermittel											Höher ↗
Störung	Faktoren																					
		Verkürzung der Werkzeugstandzeit	Schneller Verschleiß der Schneidplatte	Ungeeignete Werkzeugsorte	●																	
Ungeeignete Schneidkantengeometrie												●	↗	↗	↗	●	↘					
Ungeeignete Schneidgeschwindigkeit							↘	●	↗			●										
Absplitterung oder Bruch der Schneidkante	Ungeeignete Werkzeugsorte			●																		
	Ungeeignete Schnittbedingungen								↘	↘												
	Zu geringe Schneidkantenstärke											●		↗		↗						
	Wärmebruch				●		↘	●	↘	↘	●	●										
Aufbauschneide				●	↗	●	↗		●	●												
Unzureichende Steifigkeit																	●	●	●	●		
Außerhalb der Toleranz	Abmessungen sind nicht konstant	Unzureichende Präzision der Schneidplatte															●					
		Starker Schnittwiderstand und Freiflächenverschleiß										●	●	↘	↘	↘		●	●	●	●	
Außerhalb der Toleranz	Aufgrund von Übermaß ist eine häufige Justierung erforderlich	Ungeeignete Werkzeugsorte	●																			
		Ungeeignete Schnittbedingungen					↘	●	↗													
Verschlechterung der Oberfläche	Schlechte Oberflächenqualität	Spanverschweißung					↗	●		●	●											
		Ungeeignete Schneidkantengeometrie										●		↗								
		Rattern					↘	●	↘	↘								●	●	●	●	
Hohe Temperaturentwicklung	Werkstücküberhitzung kann Ungenauigkeit und kurze Standzeit hervorrufen	Ungeeignete Schnittbedingungen					↘	●	↘	↘												
		Ungeeignete Schneidkantengeometrie										●	↗			↘						

TECHNISCHE DATEN











P

Lösung		WSP-Sortenauswahl				Schnittbedingungen				Art und Design				Maschine Einbau des Werkzeugs						
		Wählen Sie eine härtere Sorte	Wählen Sie eine zähere Sorte	Wählen Sie eine hitzebeständige Sorte	Wählen Sie eine adhäsionsbeständige Sorte	Schnittgeschwindigkeit	Vorschub	Schnitttiefe	Kühlung	Spanbrecherwahl	Freiwinkel	Eckenradius	Anstellwinkel	Fase verstärkt die Schneidkanten	WSP - Toleranz	Verbesserte Werkzeughalter-Stabilität	Werkzeug- und Werkstückspannung erhöhen	Halterausrückung reduzieren	Leistung und Maschinenspiel verringern	
Störung		Faktoren		Höher ↗	Niedriger ↘	Kein Kühlschmiermittel	Festlegen ob mit oder ohne Kühlschmiermittel	Höher ↗	Niedriger ↘		WSP - Toleranz	Verbesserte Werkzeughalter-Stabilität	Werkzeug- und Werkstückspannung erhöhen	Halterausrückung reduzieren						Leistung und Maschinenspiel verringern
				Gratbildung, Ausbröckeln, usw.	Gratbildung (Stahl, Aluminium)	Kolkverschleiß	●													
Ungeeignete Schnittbedingungen							↙ ●	↗ ●			● Nass									
Ungeeignete Schneidkantengeometrie											●	↗ ●	↙ ●	↘ ●	↙ ●					
Ausbröckeln des Werkstücks (Gußeisen)	Ungeeignete Schnittbedingungen								↙ ●	↘ ●										
	Ungeeignete Schneidkantengeometrie										●	↗ ●	↗ ●	↗ ●	↙ ●					
	Vibrationen															●	●	●	●	
Gratbildung (Baustahl)	Ungeeignete Werkzeugsorte					●														
	Ungeeignete Schnittbedingungen						↗ ●				●	● Nass								
	Ungeeignete Schneidkantengeometrie										●	↗ ●			↙ ●					
	Vibrationen															●	●	●	●	
Schlechter Spanabfluß	Lange Späne	Ungeeignete Schnittbedingungen						↙ ●	↗ ●	↗ ●		● Nass								
		Großer Spankontrollbereich										●								
		Ungeeignete Schneidkantengeometrie											↙ ●	↘ ●						
	Späne sind kurz und verteilt	Ungeeignete Schnittbedingungen						↙ ●	↘ ●		● Trocken									
		Kleiner Spankontrollbereich									●									
		Ungeeignete Schneidkantengeometrie											↗ ●	↗ ●						

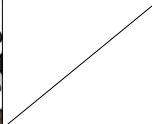

# SPANKONTROLLE BEIM DREHEN

## ■ SPANBRUCHEMPFEHLUNG BEIM DREHEN VON STAHL

Typ	A Typ	B Typ	C Typ	D Typ	E Typ
Kleine Schnitttiefe $d < 7\text{mm}$					
Große Schnitttiefe $d = 7 - 15\text{mm}$					
Spanlänge	Wirrspan	$l \geq 50\text{mm}$	$l \leq 50\text{mm}$ 1–5 Windung	$\cong 1$ Windung	Weniger als eine Windung halbe Windung
Bemerkung	<ul style="list-style-type: none"> <li>Ungewöhnlich glatte Spanausführung.</li> <li>Späne wickeln sich um Werkzeug und Werkstück</li> </ul>	<ul style="list-style-type: none"> <li>Normale glatte, gerollte Spanausführung</li> <li>Lange Späne</li> </ul>	Gut	Gut	<ul style="list-style-type: none"> <li>Späne spritzen umher</li> <li>Rattern</li> <li>Schlechte Oberflächengüte</li> </ul>

## ● Schnittgeschwindigkeit und Spankontrollbereich des Spanbrechers

Allgemein gilt: Wenn die Schnittgeschwindigkeit erhöht wird, verkleinert sich der Spankontrollbereich.

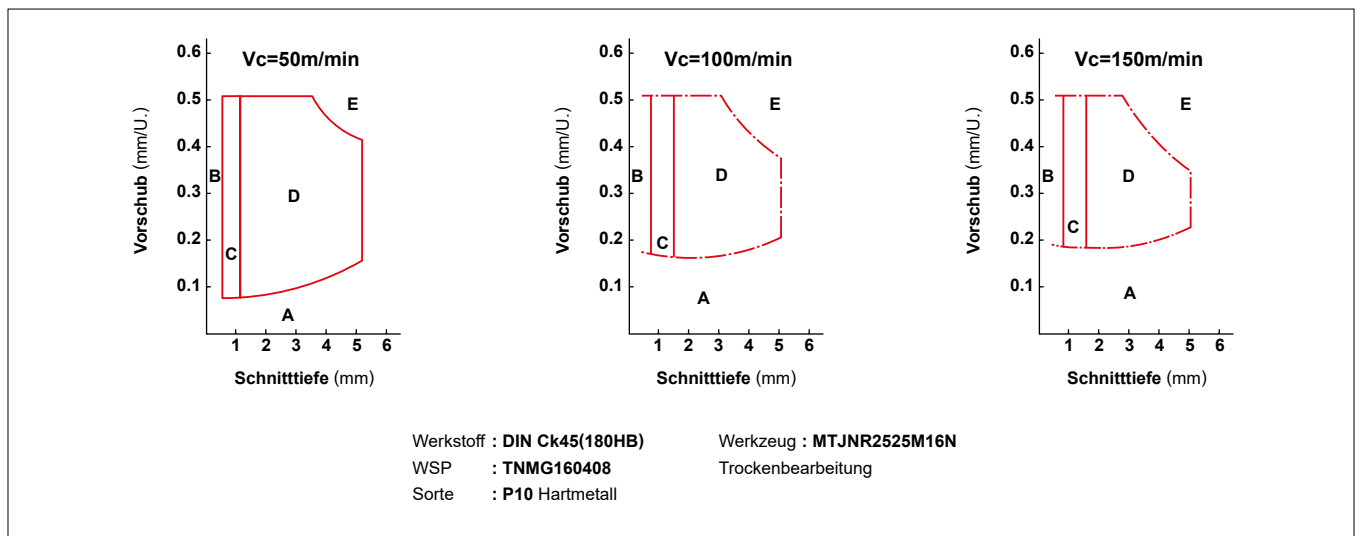

## ● Auswirkungen eines Kühlmittels auf den Spankontrollbereich eines Spanbrechers

Bei gleichbleibender Schnittgeschwindigkeit variiert die Spankontrolle in Abhängigkeit davon, ob Kühlmittel verwendet wird oder nicht.

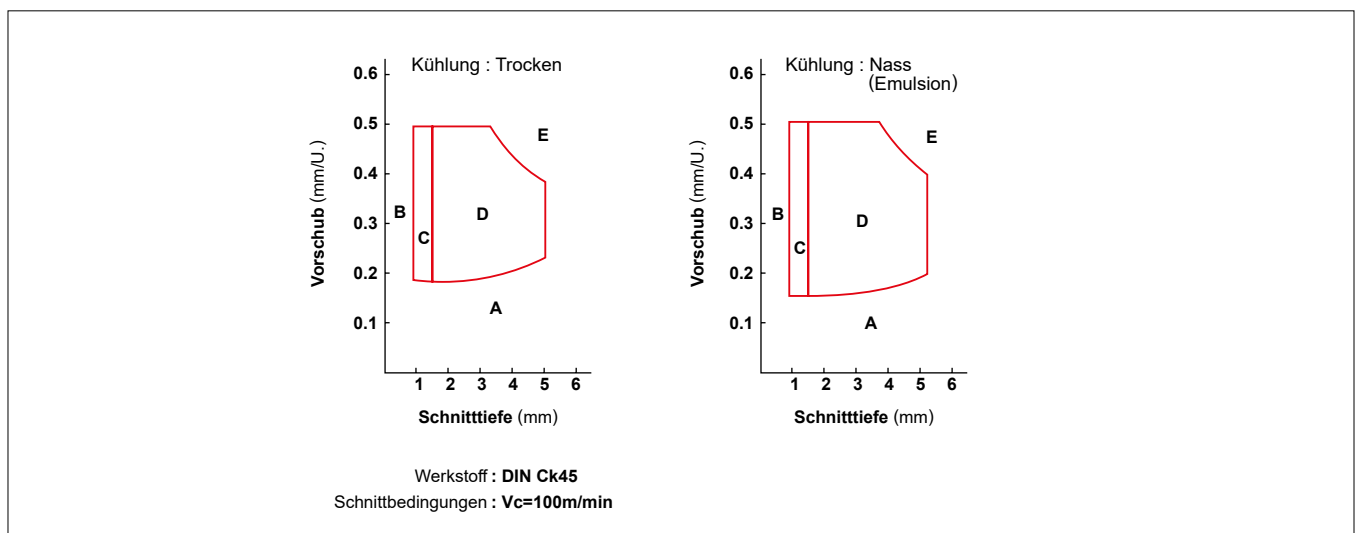

# AUSWIRKUNGEN VON SCHNITTPARAMETERN (DREHEN)

## ■ AUSWIRKUNGEN VON SCHNITTPARAMETERN

Ideale Schnittbedingungen sind kurze Bearbeitungszeit, lange Standzeit und hohe Bearbeitungsgenauigkeit. Um die optimalen Bedingungen zu finden, müssen wirtschaftliche Schnittdaten und Werkzeuge in Abhängigkeit von Werkstoff, Härte, Werkstückform und Maschinenausführung ermittelt werden.

## ■ SCHNITTGESCHWINDIGKEIT

Die Schnittgeschwindigkeit beeinflusst in hohem Maße die Standzeit. Hohe Schnittgeschwindigkeiten mit hohen Schnitttemperaturen verringern die Standzeit. Die Schnittgeschwindigkeit ist abhängig von der Form und der Härte des Werkstückes. Hartmetallsorte und Werkzeug müssen auf die Schnittgeschwindigkeit abgestimmt werden.

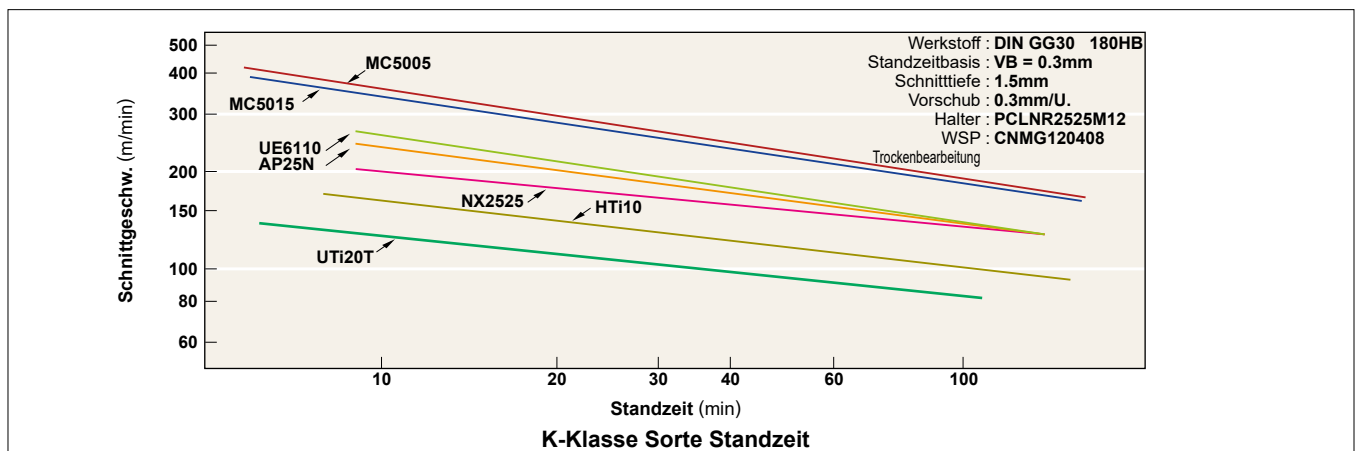
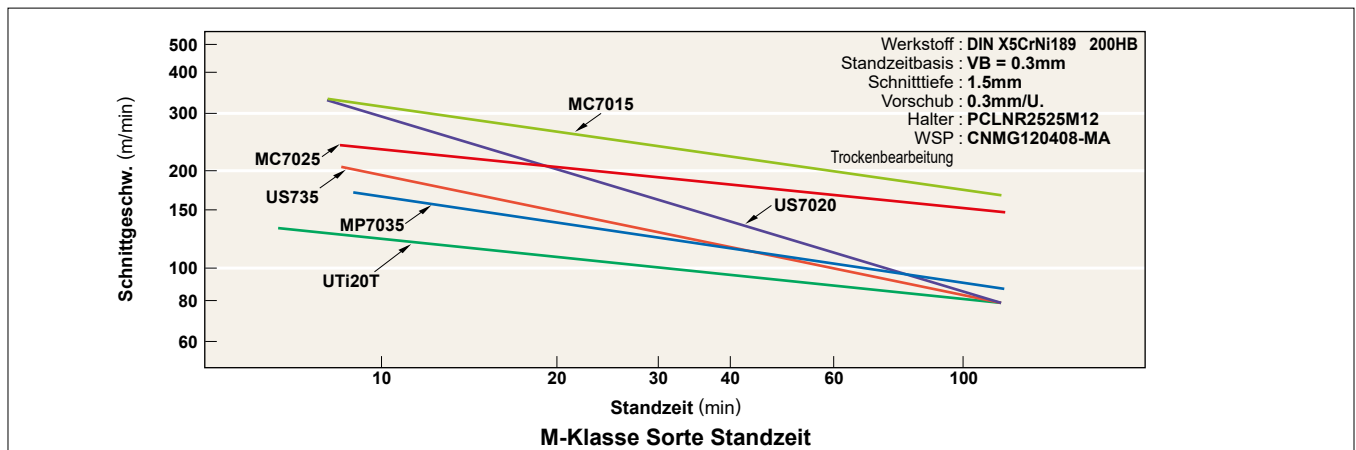
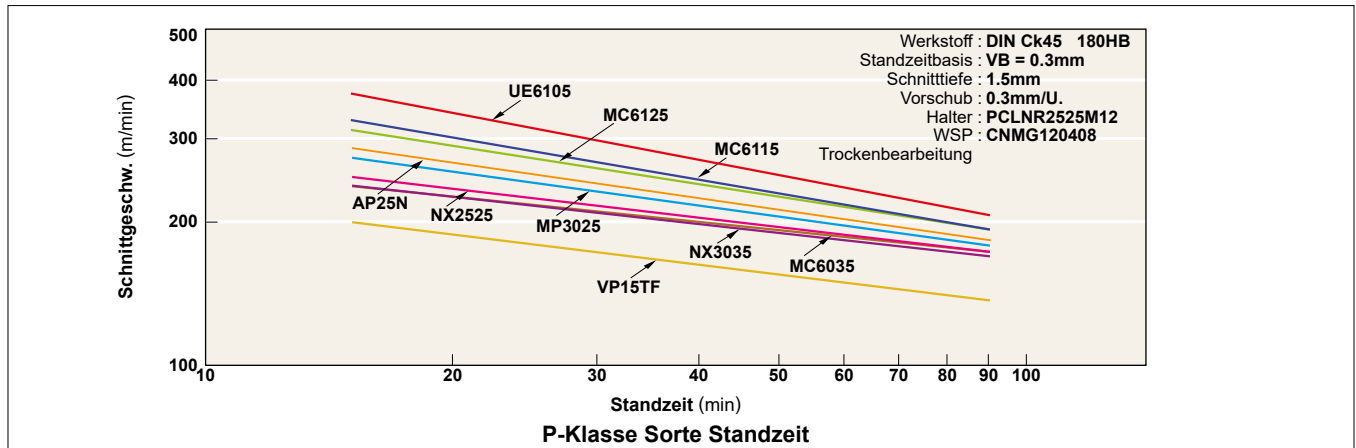

## ● Auswirkungen der Schnittgeschwindigkeit

1. Bei einer Erhöhung der Schnittgeschwindigkeit um 20% verringert sich die Standzeit auf die Hälfte. Bei einer Erhöhung der Schnittgeschwindigkeit um 50% beträgt die Standzeit nur noch 1/5.
2. Geringe Schnittgeschwindigkeit (20–40m/min) kann zu Rattern führen. Daraus resultierend ist eine geringere Lebensdauer.

# AUSWIRKUNGEN VON SCHNITTPARAMETERN (DREHEN)

## ■ VORSCHUB

Bei allg. Drehbearbeitung ist der Vorschub die Strecke, die der Halter bei einer Umdrehung zurücklegt. Bei Fräsbearbeitungen ist der Vorschub die zurückgelegte Strecke des Maschinentisches, bei einer Spindelumdrehung, geteilt durch die Anzahl der Schneidkanten. Dies wird Vorschub pro Zahn genannt. Vorschub in Abhängigkeit zur Oberflächenrauheit.

### ● Auswirkungen des Vorschubes

1. Verminderter Vorschub verursacht Freiflächenverschleiß Temperatur an der Schneide und verkürzt die Standzeit.
2. Erhöhung des Vorschubes erhöht die Schnitttemperatur und den Freiflächenverschleiß. Jedoch sind die Auswirkungen des Vorschubes, verglichen mit den Auswirkungen der Schnittgeschwindigkeit auf die Standzeit, gering.
3. Hohe Vorschübe erhöhen die Maschinenwirtschaftlichkeit.

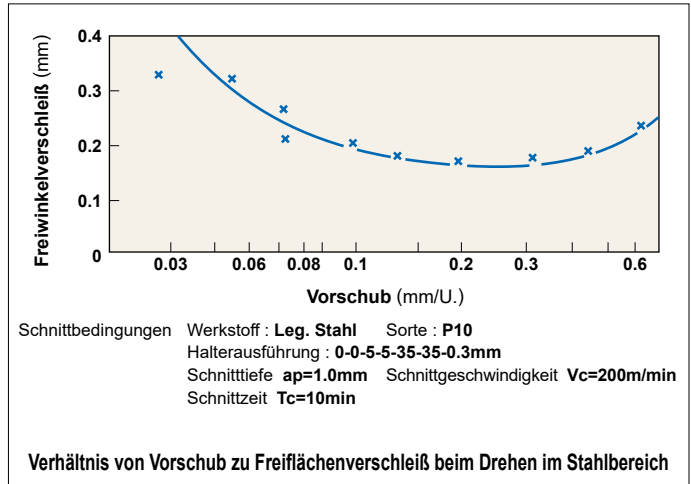

## ■ SCHNITTtiefe

Die Schnitttiefe ist abhängig von der Bearbeitungsart, der Form des Werkstückes, der Maschinenleistung und Stabilität und der Werkzeugsteifigkeit.

### ● Auswirkungen der Schnitttiefe

1. Schnitttiefenwechsel haben kaum Auswirkungen auf die Standzeit.
2. Kleine Schnitttiefen und das Bearbeiten von harten Werkstoffoberflächen bewirkt einen großen Abrieb an der Schneidkante. Dies beeinträchtigt die Standzeit.
3. Beim Bearbeiten von Rohmaterial oder Grauguß sollte die Schnitttiefe soweit erhöht werden, dass der Schneidkantenradius außerhalb der harten Zone ist. Voraussetzung hierfür ist, dass dies die Maschinenleistung zulässt. Dies ermöglicht besseren Spanbruch und keinen unnötigen Standzeitverlust.

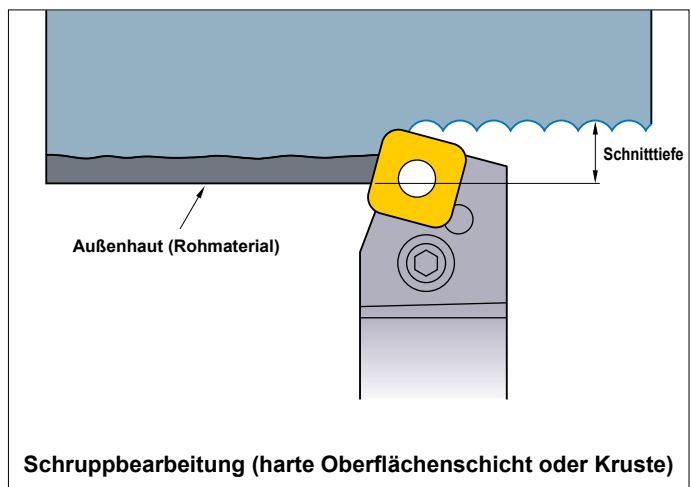
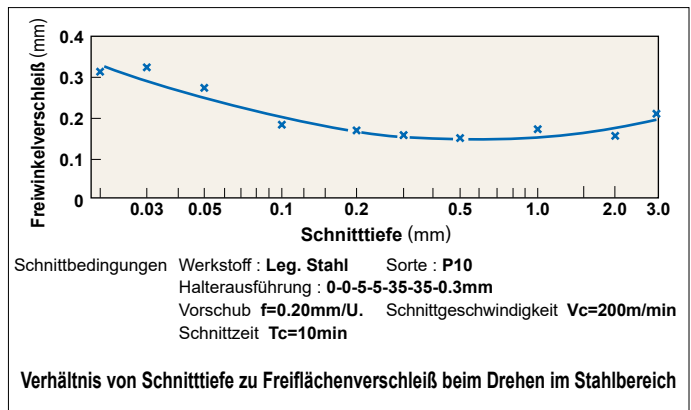

# FUNKTION DER WERKZEUGEIGENSCHAFTEN (DREHEN)

## ■ SPANWINKEL

Der Spanwinkel hat einen starken Einfluss auf Schnittleistung, Spanabfuhr, Schnitttemperatur und Standzeit.

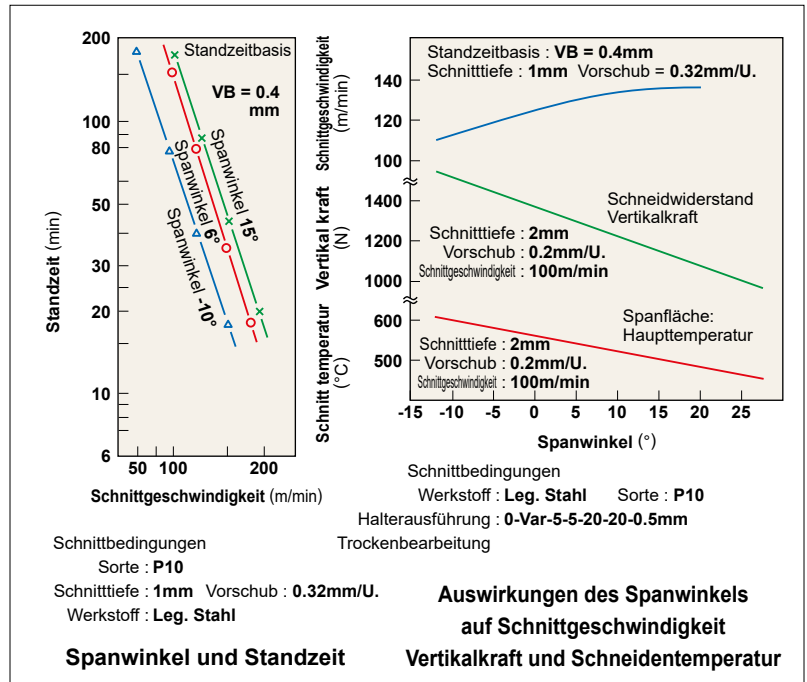
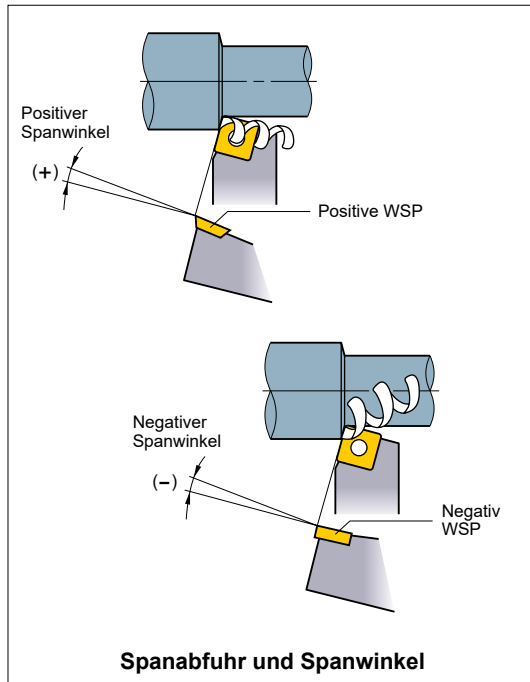

### ● Auswirkungen des Spanwinkels

1. Vergrößern des Spanwinkels in die positive Richtung bewirkt eine größere Schärfe der Schneidkante.
2. Vergrößern des Spanwinkels um  $1^\circ$  in die positive Richtung vermindert die Schnittleistung um 1%.
3. Vergrößern des Spanwinkels in die positive Richtung vermindert die Schnittleistung und in negativer Richtung wird der Schnittwiderstand erhöht.

### Wann wird ein negativer Spanwinkel gebraucht?

- Harte Werkstoffe.
- Wenn eine stabile Schneidkante z.B. für unterbrochenen Schnitt oder Krustendrehen verlangt wird.

### Wann wird ein positiver Spanwinkel gebraucht?

- Weiche Werkstoffe.
- Bei einfach bearbeitbaren Werkstoffen.
- Wenn Werkstück oder Maschine nicht ausreichend stabil sind.

## ■ FREIWINKEL

Der Freiwinkel schützt die Freifläche gegenüber dem Werkstoff gegen Reibung und gewährleistet einen gleichmäßigen Vorschub.

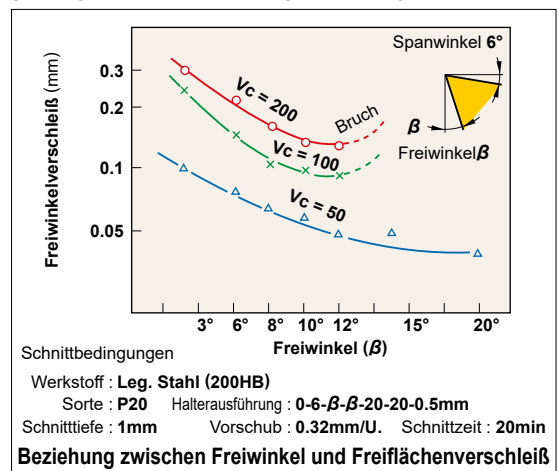
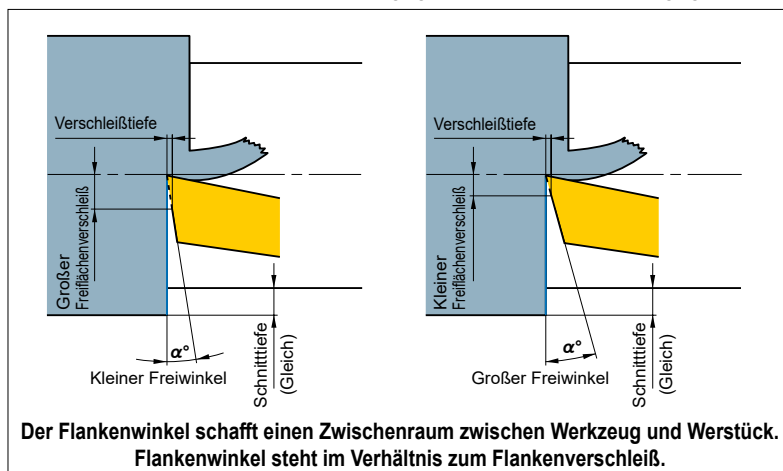

### ● Auswirkungen des Freiwinkels

1. Erhöhung des Freiwinkels senkt den Freiflächenverschleiß.
2. Erhöhung des Freiwinkels senkt die Schneidkantenstärke.

### Wann sollte der Freiwinkel gesenkt werden?

- Harte Werkstücke.
- Wenn eine harte Schneidkante benötigt wird.

### Wann sollte der Freiwinkel erhöht werden?

- Weiche Werkstoffe.
- Werkstoffe, die zur Kaltverfestigung neigen.

# FUNKTION DER WERKZEUGEIGENSCHAFTEN (DREHEN)

## ■ SCHNEIDKANTENWINKEL (EINSTELLWINKEL)

Der Einstell- und Eckenwinkel beeinflusst die Vorschub- und Rückkraft sowie die Spandicke.

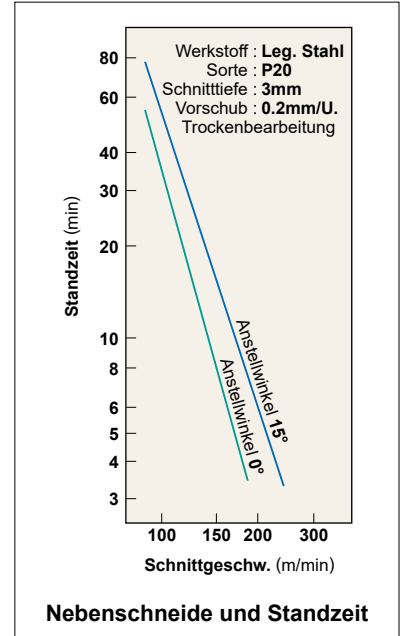
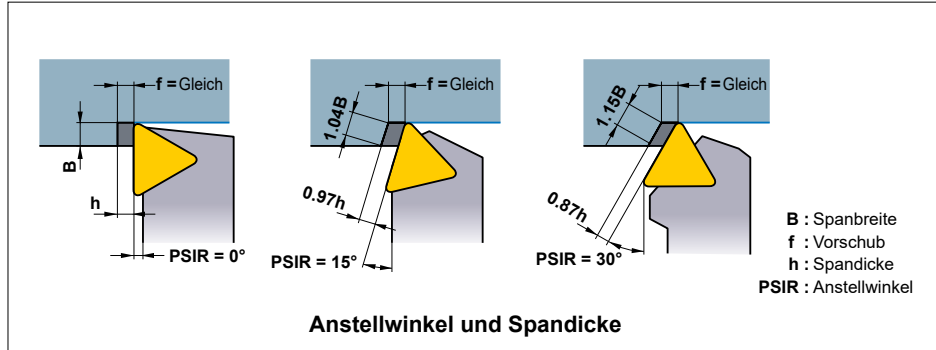

### ● Auswirkungen des Schneidkantenwinkels (Einstellwinkel)

1. Bei gleichbleibendem Vorschub erhöht sich bei steigendem Einstellwinkel die Schneidkantenlänge und die Spandicke nimmt ab. Dies hat zur Folge, dass die Schnittkraft sich auf eine längere Schneidkante verteilt und die Standzeit erhöht wird. (siehe Tabelle.)
2. Wenn der Einstellwinkel erhöht wird, steigt die Schnittkraft  $a'$ . Es kann passieren, dass lange, dünne Werkstücke von dieser Kraft abgedrängt werden.
3. Je größer der Einstellwinkel ist, umso schwieriger wird die Spanbruchkontrolle.
4. Ein größerer Spanwinkel vermindert die Spandicke und erhöht die Spanbreite. Dies erschwert den Spanbruch.

**Der Einstellwinkel wird verkleinert**

- Bei Schlichtbearbeitung mit geringer Schnitttiefe.
- Bei langen, dünnen Werkstücken.
- Bei geringer Maschinenstabilität.

**Der Einstellwinkel wird vergrößert**

- Harte Werkstoffe, die beim Bearbeiten hohe Schnitttemperaturen verursachen.
- Schrumpfen von Werkstücken mit ausreichendem Durchmesser.
- Bei hoher Maschinenstabilität.

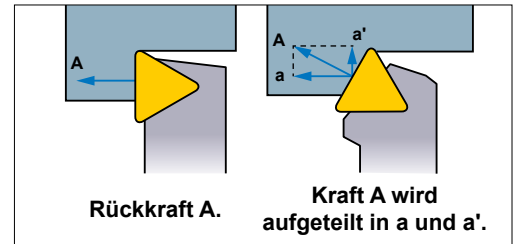

### ■ Winkel der Nebenschneide

Ein großer Nebenschneidenwinkel ( $5^\circ$ - $15^\circ$ ) verhindert, dass es beim Konturdrehen zu einer Berührung der Werkstückoberfläche und der Nebenschneide kommt.

### ● Auswirkungen des Nebenschneidenwinkels

1. Eine Verkleinerung des Nebenschneidenwinkels erhöht die Stabilität der Schneide, führt aber auch zu einer höheren Schnitttemperatur.
2. Eine Verkleinerung des Nebenschneidenwinkels erhöht die Schnittkraft und kann zu Rattermarken und Vibrationen führen.
3. Es wird ein kleiner Nebenschneidenwinkel für das Schrumpfen und ein großer für das Schlichten empfohlen.

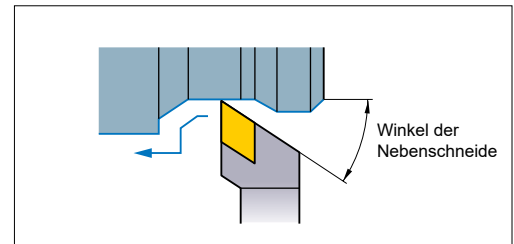

### ■ Neigungswinkel

Der Neigungswinkel liegt zwischen der Hauptschneide und einer waagerechten Bezugsebene. Der Neigungswinkel ist negativ wenn die Hauptschneide von der Schneidenecke nach vorn abfällt. Beim Schrumpfen wird die Schneidkante beim Anschneiden stark beansprucht. Ein Neigungswinkel schützt die Schneide vor Schlagbeanspruchung und verhindert somit einen Schneidenbruch. Empfohlen wird  $-3^\circ$ – $-5^\circ$  für Längsdrehen und  $-10^\circ$ – $-15^\circ$  für Plandrehen.

### ● Auswirkungen des Neigungswinkels

1. Negative Schneidkantenneigung leitet die Spanabfuhr zum Werkstück hin, positive leitet die Spanabfuhr vom Werkstück weg.
2. Negative Schneidkantenneigung erhöht die Stabilität der Schneidkante, aber auch die Gegenkraft des Schneidwiderstandes wird erhöht.

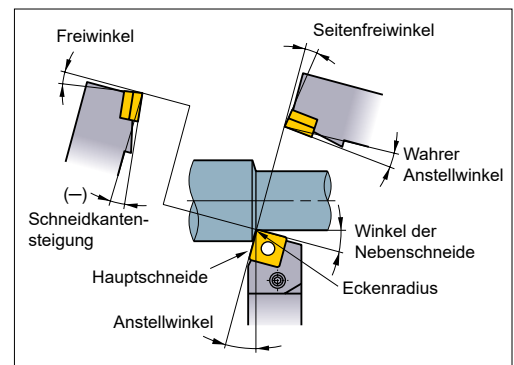

## ■ HONEN UND FASENBREITE

"Honing" und "Land" sind Schneidkantenformen, durch die die Schneidkante verstärkt wird.

Honing kann sowohl als runde als auch als abgeschrägte Fase ausgeführt sein.

Die optimale Fassenbreite beträgt ca. die Hälfte des Vorschubs.

Als Land bezeichnet man die kleine rechteckige Fläche auf der Span- oder Freifläche (0° Primärfase).

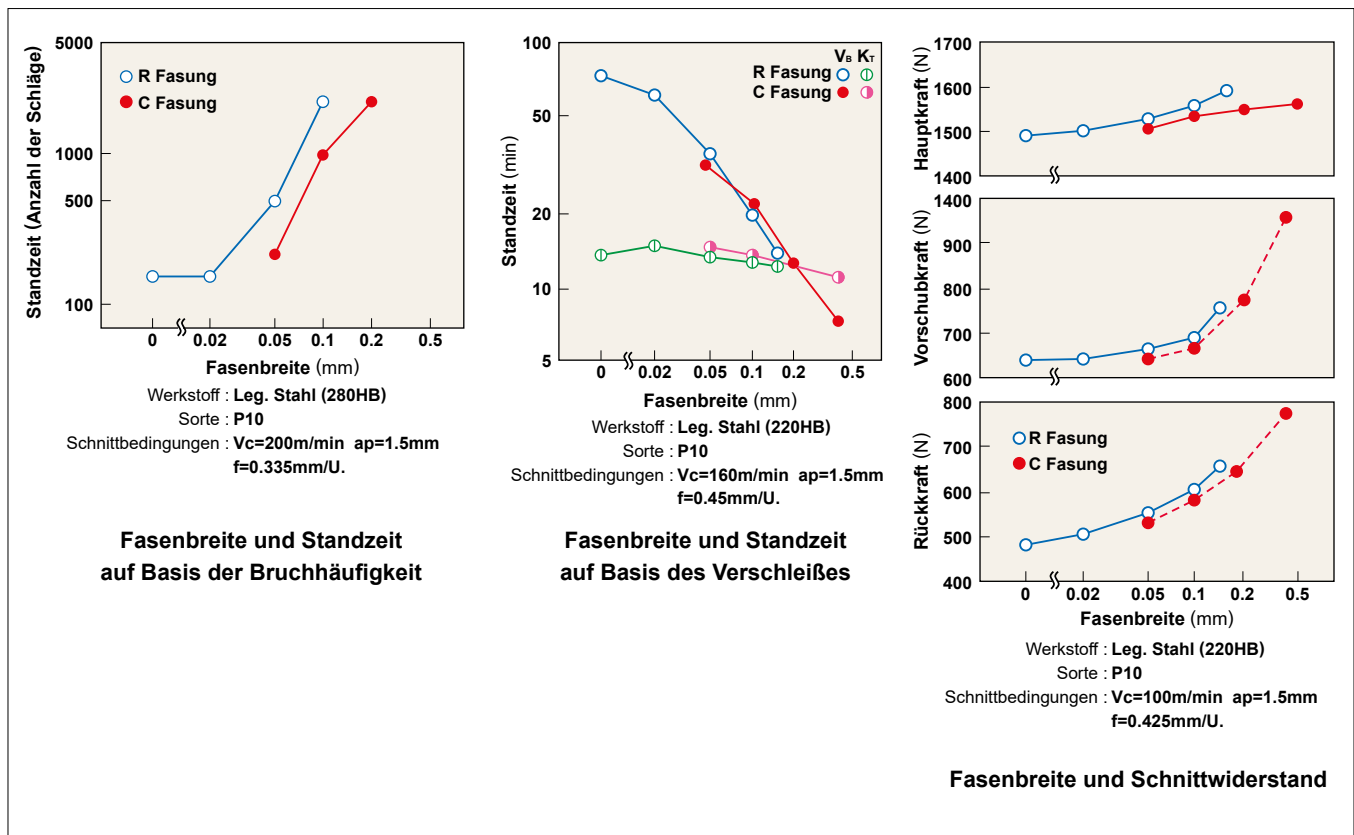
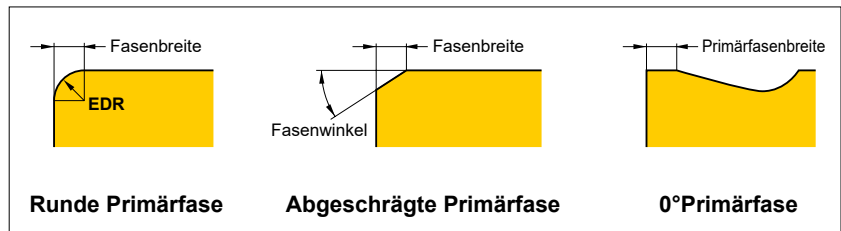

## ● Auswirkungen der Fassungen

1. Vergrößerung der Fassenbreite erhöht die Schneidkantenstärke, die Standzeit und verhindert Brüche.
2. Vergrößerung der Fassenbreite erhöht den Freiflächenverschleiß und verringert die Standzeit. Die Fassenbreite hat keine Auswirkung auf den Kolkverschleiß.
3. Vergrößerung der Fassenbreite erhöht den Schneidwiderstand und die Möglichkeit des Ratterns.

Wann sollte die Fassenbreite verringert werden?
<input type="radio"/> Beim Schlichten mit geringer Schnitttiefe und kleinem Vorschub.
<input type="radio"/> Weiche Werkstoffe.
<input type="radio"/> Bei geringer Stabilität der Maschine und des Werkstücks.

Wann sollte die Fassenbreite vergrößert werden?
<input type="radio"/> Harte Werkstücke.
<input type="radio"/> Wenn Schneidkantenfestigkeit für unbearbeitete Flächen und unterbrochenen Schnitt erforderlich ist.
<input type="radio"/> Bei hoher Maschinenstabilität.

Hinweis 1) Hartmetall, UTi beschichtete Diamant- und Cermet-WSP haben bereits runde Fasen (Standard).

# FUNKTION DER WERKZEUGEIGENSCHAFTEN (DREHEN)

## ■ RADIUS

Der Schneidkantenradius beeinflusst die Schneidkantenstärke. Im Allgemeinen sollte der Vorschub das 2–3-fache des Radius sein.

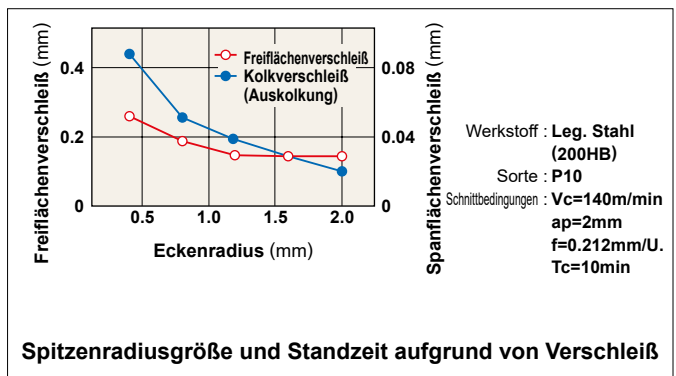
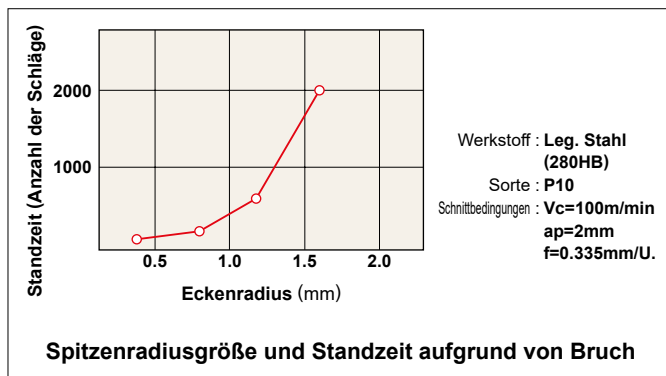
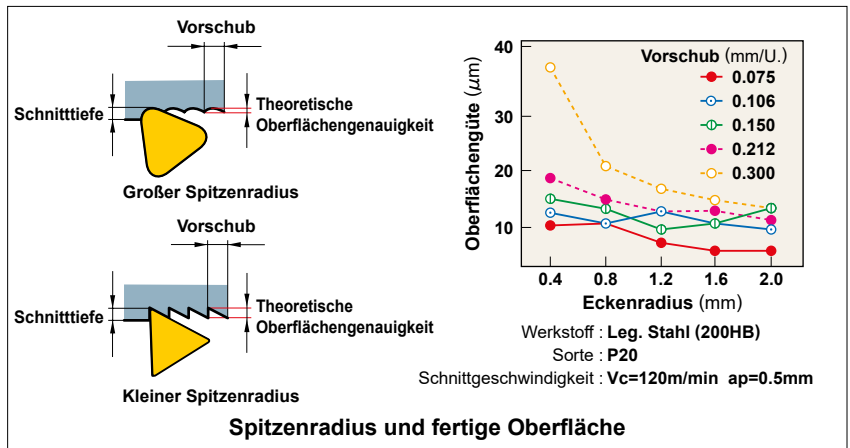

## ● Wirkung des Spitzradius

1. Vergrößern des Spitzradius verbessert die Oberflächenqualität.
2. Vergrößern des Spitzradius verbessert die Schneidkantenstärke.
3. Zu großer Spitzradius erhöht den Schnittwiderstand und verursacht Rattern.
4. Vergrößern des Spitzradius verringert Freiflächen- und Kolkverschleiß.
5. Zu großer Spitzradius ergibt schlechte Spankontrolle.

### Wann sollte der Spitzradius verringert werden?

- Bei Schlichtbearbeitung mit geringer Schnitttiefe.
- Bei langen, dünnen Werkstücken.
- Bei hoher Maschinenstabilität.

### Wann sollte der Spitzradius vergrößert werden?

- Wenn eine hohe Schneidkantenstabilität benötigt wird, wie z. B. bei unbearbeiteten Oberflächen und Schnittunterbrechungen.
- Bei Schruppbearbeitung eines Werkstückes mit großem Durchmesser.
- Bei hoher Maschinenstabilität.

## ● Spitzenradius und Spankontrollbereich

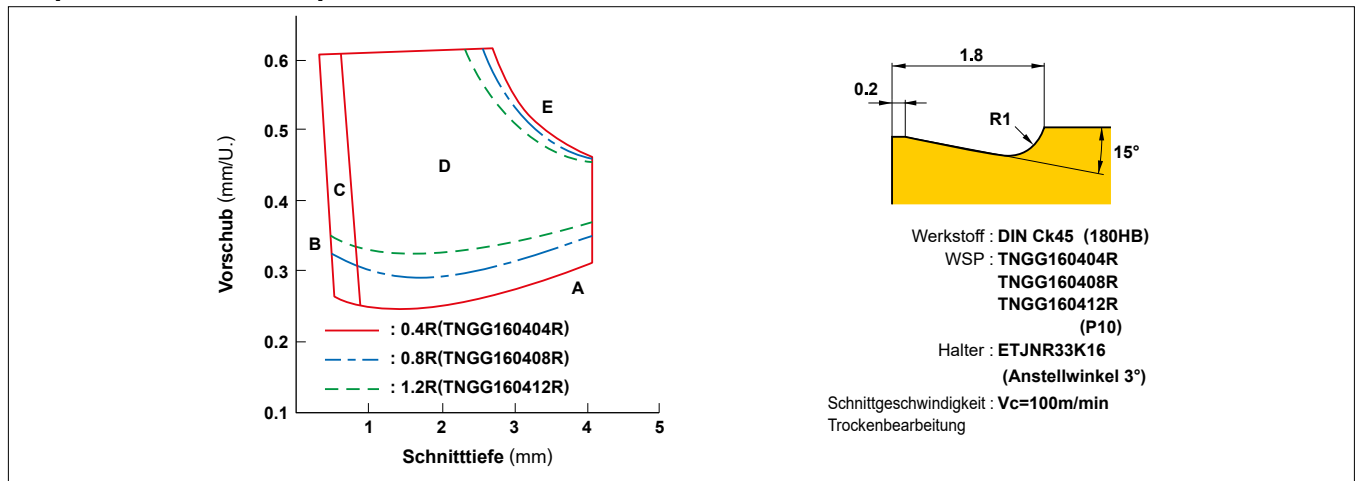

Hinweis 1) Siehe Seite P008 für Spanformen (A, B, C, D, E).



# KALKULATIONSFORMELN (LEISTUNGS-AUFNAHME)

## LEISTUNGS-AUFNAHME DREHEN (Pc)

$$P_c = \frac{a_p \cdot f \cdot V_c \cdot K_c}{60 \times 10^3 \cdot \eta} \quad (\text{kW})$$

**P<sub>c</sub> (kW)** : Leistungsaufnahme  
**f (mm/U.)** : Vorschub pro Umdrehung  
**K<sub>c</sub> (MPa)** : Schnittwiderstand  
**a<sub>p</sub> (mm)** : Schnitttiefe  
**V<sub>c</sub> (m/min)** : Schnittgeschwindigkeit  
**η** : (Wirkungsgrad)

(Beispiel) Ermitteln Sie die benötigte Leistungsaufnahme zur Bearbeitung von Baustahl mit einer Schnittgeschwindigkeit von 120m/min, einer Schnitttiefe 3mm und einem Vorschub 0.2mm/U. Wirkungsgrad 80%.

(Lösung) Ersetzt die Schnittkraft K<sub>c</sub>=3100MPa in der Formel.

$$P_c = \frac{3 \times 0.2 \times 120 \times 3100}{60 \times 10^3 \times 0.8} = 4.65 \text{ (kW)}$$

### K<sub>c</sub>

Werkstoff	Zugfestigkeit (MPa) und Härte	Schnittwiderstand K <sub>c</sub> (MPa)				
		0.1 (mm/U.)	0.2 (mm/U.)	0.3 (mm/U.)	0.4 (mm/U.)	0.6 (mm/U.)
Baustahl	520	3610	3100	2720	2500	2280
Legierter Stahl	620	3080	2700	2570	2450	2300
Gehärteter Stahl	720	4050	3600	3250	2950	2640
Werkzeugstahl	670	3040	2800	2630	2500	2400
Werkzeugstahl	770	3150	2850	2620	2450	2340
Chrom-Mangan Stahl	770	3830	3250	2900	2650	2400
Chrom-Mangan Stahl	630	4510	3900	3240	2900	2630
Chrom-Molybdän Stahl	730	4500	3900	3400	3150	2850
Chrom-Molybdän Stahl	600	3610	3200	2880	2700	2500
Nickel-Chrom-Molybdän Stahl	900	3070	2650	2350	2200	1980
Nickel-Chrom-Molybdän Stahl	352HB	3310	2900	2580	2400	2200
Duktiler Grauguss	46HRC	3190	2800	2600	2450	2270
Guss	360	2300	1930	1730	1600	1450
Grauguss	200HB	2110	1800	1600	1400	1330

## SCHNITTGESCHWINDIGKEIT (Vc)

$$V_c = \frac{\pi \cdot D_m \cdot n}{1000} \quad (\text{m/min})$$

**V<sub>c</sub> (m/min)** : Schnittgeschwindigkeit  
**D<sub>m</sub> (mm)** : Werkstück Durchmesser  
**π (3.14)** : Pi  
**n (U/min)** : Drehzahl

\*Teilen Sie durch 1000 zur Umrechnung von m in mm.

(Beispiel) Ermitteln Sie die Schnittgeschwindigkeit bei einer Spindelumdrehung von 700U/min und einem Werkstückdurchmesser von 50mm.

(Lösung) Setzen Sie π=3.14, D<sub>m</sub>=50, n=700 in die Formel.

$$V_c = \frac{\pi \cdot D_m \cdot n}{1000} = \frac{3.14 \times 50 \times 700}{1000} = 110 \text{ m/min}$$

Die Schnittgeschwindigkeit ist 110m/min.

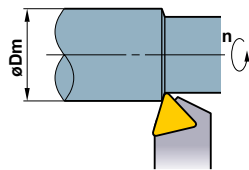

## VORSCHUB (f)

$$f = \frac{l}{n} \quad (\text{mm/U.})$$

**f (mm/U.)** : Vorschub pro Umdrehung  
**l (mm/min)** : Schnittlänge pro Minute  
**n (U/min)** : Drehzahl

(Beispiel) Ermitteln Sie den Vorschub pro Umdrehung bei einer Drehzahl von 500U/min und einem Vorschub von 120mm/min.

(Lösung) Setzen Sie n=500, l=120 in die Formel.

$$f = \frac{l}{n} = \frac{120}{500} = 0.24 \text{ mm/U.}$$

Der Vorschub beträgt 0.24mm/U.

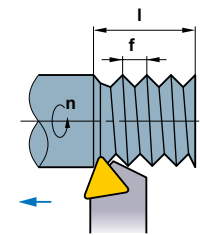

## SCHNITTZEIT (Tc)

$$T_c = \frac{l_m}{l} \quad (\text{min})$$

**T<sub>c</sub> (min)** : Schnittzeit  
**l<sub>m</sub> (mm)** : Werkstücklänge  
**l (mm/min)** : Schnittlänge pro Minute

(Beispiel) Ermitteln Sie die Schnittzeit bei einer Werkstücklänge von 100mm, bei einer Drehzahl von 1000U/min, einem Vorschub von 0.2mm/U.

(Lösung) Berechnen Sie die Schnittlänge aus Vorschub und Drehzahl.

$$l = f \cdot n = 0.2 \times 1000 = 200 \text{ mm/min}$$

Setzen Sie Ihr Ergebnis in die Formel ein.

$$T_c = \frac{l_m}{l} = \frac{100}{200} = 0.5 \text{ min}$$

0.5 x 60=30 (sec.) Das Ergebnis ist 30s.

## THEORETISCHE OBERFLÄCHENGENAUGKEIT(h)

$$h = \frac{f^2}{8RE} \times 1000 \quad (\mu\text{m})$$

**h (μm)** : Oberflächenrauigkeit  
**f (mm/U.)** : Vorschub pro Umdrehung  
**RE (mm)** : WSP Spitzenradius

(Beispiel) Ermitteln Sie die theoretische Oberflächenrauigkeit, wenn der WSP Spitzenradius 0.8mm beträgt und der Vorschub 0.2mm/U. Ist.

(Lösung) Setzen Sie f=0.2mm/U. RE=0.8in die Formel ein.

$$h = \frac{0.2^2}{8 \times 0.8} \times 1000 = 6.25 \mu\text{m}$$

Die theoretische Oberflächenrauigkeit beträgt 6μm.

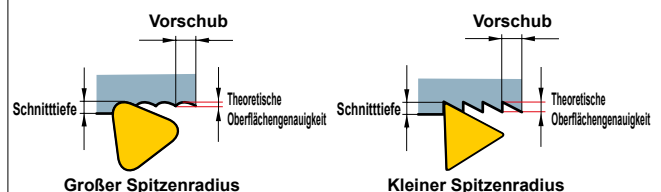

# Fehlerbehebung bei der Gewindebearbeitung

Probleme	Störungen	Gründe	Lösungen	
Nicht in Toleranz	Gewindeabmessungen nicht konstant bzw. abweichend	Inkorrekte Werkzeuginstallation oder geringe Stabilität des Werkstücks oder des Werkzeugs.	Mittenhöhe einstellen.	
			Maschine kontrollieren.	
	Niedriges Gewindeprofil	Inkorrekte Schnitttiefe oder zu hohe Auskraglänge.	Verändern Sie die Schnitttiefe.	
		Verschleiß der WSP.	Siehe Hinweise auf G034.	
Schlechte Oberflächengüte	Beschädigtes Gewinde	Spänestau oder schlechter Spanfluss.	Verwenden Sie eine modifizierte Flankenzustellung.	
			Verwenden Sie eine M-Toleranz WSP mit 3D-Geometrie.	
		Die WSP steht über der Werkstückachse.	Mittenhöhe einstellen.	
	Gratbildung	Aufbauschneidenbildung.	Erhöhen Sie die Schnittparameter. (Sofern Maschinenleistung dies zulässt)	
			Erhöhen Sie Druck und Menge der Kühlmittelzufuhr.	
		Zu hoher Schnittwiderstand.	Reduzieren Sie die Schnitttiefe.	
	Rattermarken	Zu hohe Schnittgeschwindigkeit.	Reduzieren Sie die Schnittgeschwindigkeit.	
		Instabile Werkzeug- oder Werkstückbefestigung.	Kontrollieren Sie die Werkzeug- und Werkstückklemmung.	
		Inkorrekte Werkzeug Installation oder geringe Stabilität des Werkstücks oder des Werkzeugs.	Mittenhöhe einstellen.	
	Geringe Standzeit	Sofortiger Freiflächenverschleiß an der WSP	Zu hohe Schnittgeschwindigkeit.	Reduzieren Sie die Schnittgeschwindigkeit.
Zu viele Durchgänge erhöhen den Verschleiß.			Reduzieren Sie die Anzahl der Durchgänge.	
Probleme bei der Endbearbeitung.			Es empfiehlt sich einen Leerschnitt vorzunehmen.	
Ungleichmäßiger Verschleiß der Schneidkanten		Wendeschneidplatte steht über Werkstückachse.	Überprüfen Sie die Anstellwinkel und wählen Sie eine passende Unterlegplatte aus.	
Schneidenausbruch oder Ausbröckelung		Schnittgeschwindigkeit ist zu niedrig.		Erhöhen Sie die Schnittparameter. (Sofern Maschinenleistung dies zulässt)
			Zu hoher Schnittwiderstand.	Erhöhen Sie die Anzahl der Durchgänge.
		Instabile Werkzeug- oder Werkstückbefestigung.		Überprüfen Sie die Werkstückspannung.
				Reduzieren Sie die Werkzeugauskrägung.
				Kontrollieren Sie die Werkzeug- und Werkstückklemmung.
		Spänestau oder schlechter Spanfluss.		Erhöhen Sie die Kühlmittelzufuhr oder den Druck.
				Verwenden Sie eine M-Toleranz WSP mit 3D-Geometrie.
				Erhöhen Sie die Schnittparameter. (Sofern Maschinenleistung dies zulässt)
		Werkstücke ohne Kantenbruch erzeugen beim Anfang des Durchgangs hohe Schnittkräfte.	Es empfiehlt vor den Gewindeschneiden einen Kantenbruch anzubringen um die Schnittkräfte zu reduzieren.	
Hohe plastische Deformation		Hohe Schnittgeschwindigkeit und Temperaturentwicklung.	Reduzieren Sie die Schnittgeschwindigkeit.	
		Geringe Kühlung.		Überprüfen Sie eine ausreichende Kühlmittelzufuhr.
				Erhöhen Sie Druck und Menge der Kühlmittelzufuhr.
	Zu hoher Schnittwiderstand.	Erhöhen Sie die Anzahl der Durchgänge.		

# GEWINDESCHNEIDMETHODE

## GEWINDESCHNEIDMETHODE

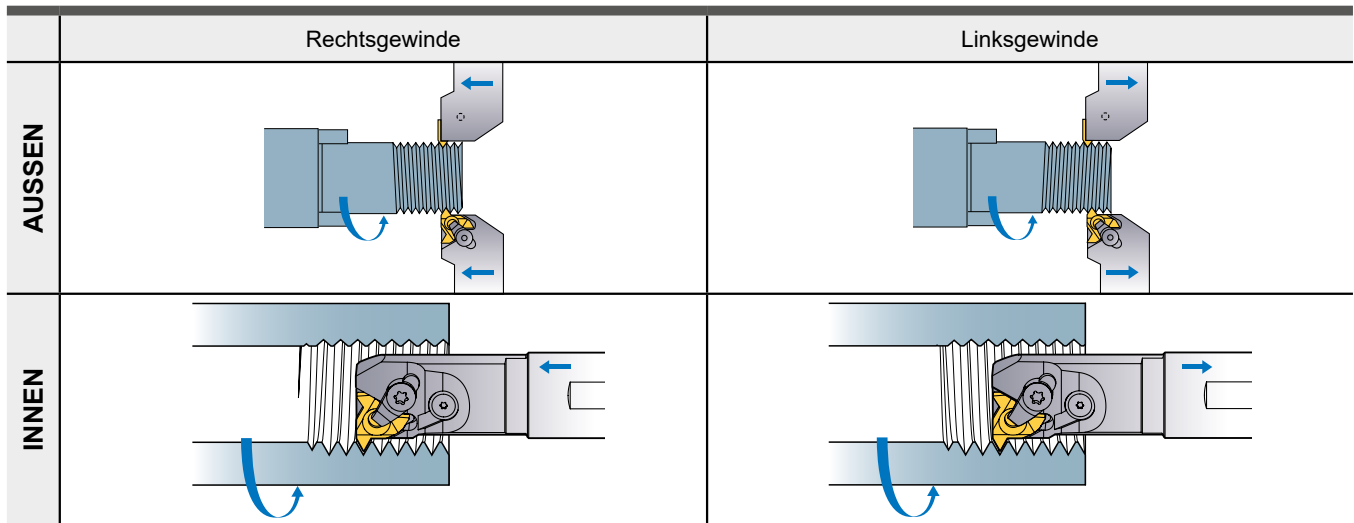

## WENDESCHNEIDPLATTENAUSFÜHRUNGEN

Teilprofil	Vollprofil	Teilprofil (nur für Trapezgewinde)
<ul style="list-style-type: none"> <li>● Die gleiche WSP kann für unterschiedliche Steigungen eingesetzt werden.</li> <li>● Kleiner WSP Radius führt zu kürzeren Standzeiten.</li> <li>● Zusätzliche Bearbeitung für Gewindespitze nötig.</li> </ul>	<ul style="list-style-type: none"> <li>● Kein Entgraten nach den Gewindeschneiden nötig.</li> <li>● Erfordert verschiedene Gewindeschneidplatten.</li> </ul>	<ul style="list-style-type: none"> <li>● Kein Entgraten nach dem Gewindeschneiden nötig.</li> <li>● Erfordert verschiedene Gewindeschneidplatten.</li> <li>● Zusätzliche Bearbeitung für Gewindespitze nötig.</li> </ul>
<p>Gewindespitzenradius (Zusätzliche Bearbeitung für Gewindespitze nötig)</p>	<p>Gewindespitzenradius (Vollprofil)</p>	<p>Gewindespitzenradius (Gewindespitze verrundet, zusätzliche Bearbeitung für Gewindespitze nötig)</p>

## ZUSTELLUNG

	Radiale Zustellung	Flankenzustellung	Modifizierte Flankenzustellung	Zustellungszunahme	
Eigenschaften	Vorteile	<ul style="list-style-type: none"> <li>● Einfach zu handhaben. (Standardbearbeitung für Gewinde.)</li> <li>● Breiter Anwendungsbereich (Einfache Änderung der Schnittdaten.)</li> <li>● Gleicher Verschleiß von linker und rechter Schneidkante.</li> </ul>	<ul style="list-style-type: none"> <li>● Einfach zu handhaben. (Semi-Standard Programm für Gewinde drehen.)</li> <li>● Reduzierte Schnittkräfte.</li> <li>● Geeignet für große Steigungen und bei Fließspanbildung.</li> <li>● Guter Spanabfluß.</li> </ul>	<ul style="list-style-type: none"> <li>● Verhindert Verschleiß der rechten Schneidkante.</li> <li>● Reduzierte Schnittkräfte.</li> <li>● Geeignet für große Steigungen und bei Fließspanbildung.</li> <li>● Guter Spanabfluß.</li> </ul>	<ul style="list-style-type: none"> <li>● Gleicher Verschleiß von linker und rechter Schneidkante.</li> <li>● Reduzierte Schnittkräfte.</li> <li>● Geeignet für große Steigungen und bei Fließspanbildung.</li> </ul>
	Nachteile	<ul style="list-style-type: none"> <li>● Keine Spankontrolle.</li> <li>● Neigt zu Vibration bei großen Schnitttiefen.</li> <li>● Nicht geeignet für große Steigungen.</li> <li>● Hohe Belastungen am Spitzenradius.</li> </ul>	<ul style="list-style-type: none"> <li>● Verschleiß der rechten Schneidkante.</li> </ul>	<ul style="list-style-type: none"> <li>● Komplizierte Programmierung.</li> </ul>	<ul style="list-style-type: none"> <li>● Komplizierte Programmierung.</li> <li>● Schlechte Spankontrolle.</li> </ul>

# GEWINDESCHNEIDMETHODE

## GEWINDETIEFE

		Eigenschaften	
		Vorteile	Nachteile
<p>Schnittbereich</p>	<ul style="list-style-type: none"> <li>● Einfach zu handhaben (Standardbearbeitung für Gewinde)</li> <li>● Einsatz gegen Vibrationen (Konstante Schnittkräfte)</li> </ul>	<ul style="list-style-type: none"> <li>● Lange Späne während des letzten Durchgangs</li> </ul>	
	<p>Schnitttiefe</p>		<ul style="list-style-type: none"> <li>● Geringere Belastung am Spitzenradius während der ersten Durchgänge</li> <li>● Gute Spankontrolle</li> <li>● Gute Spanabfluß</li> </ul>

Hinweis 1) Empfohlene Schnitttiefe für den letzten Durchgang sind 0.05mm—0.025mm.  
Zu große Schnitttiefen führen zu Vibrationen und schlechten Oberflächen.

## ■ DATEN

### ● Daten zur Berechnung der Zustellung bei jedem Durchgang in reduzierten Ausführungen.

$\Delta ap_n = \frac{ap}{\sqrt{n_{ap}-1}} \times \sqrt{b}$	<p>(Beispiel) Aussengewinde drehen (Metrisch ISO) Steigung : 1.0mm ap : 0.6mm n<sub>ap</sub> : 5 Durchgänge</p>
<p> <math>\Delta ap_n</math> : Schnitttiefe  n : Aktuelle Durchgänge  ap : Schnitttiefe  n<sub>ap</sub> : Anzahl der Durchgänge  b : 1. Durchgang 0.3  2. Durchgang 2-1 = 1  3. Durchgang 3-1 = 2  ⋮  n-ter Durchgang </p>	<p>1. Durchgang <math>\Delta ap_1 = \frac{0.60}{\sqrt{5-1}} \times \sqrt{0.3} = 0.16 \rightarrow \mathbf{0.16} (\Delta ap_1)</math></p> <p>2. Durchgang <math>\Delta ap_2 = \frac{0.60}{\sqrt{5-1}} \times \sqrt{2-1} = 0.3 \rightarrow \mathbf{0.14} (\Delta ap_2 - \Delta ap_1)</math></p> <p>3. Durchgang <math>\Delta ap_3 = \frac{0.60}{\sqrt{5-1}} \times \sqrt{3-1} = 0.42 \rightarrow \mathbf{0.12} (\Delta ap_3 - \Delta ap_2)</math></p> <p>4. Durchgang <math>\Delta ap_4 = \frac{0.60}{\sqrt{5-1}} \times \sqrt{4-1} = 0.52 \rightarrow \mathbf{0.1} (\Delta ap_4 - \Delta ap_3)</math></p> <p>5. Durchgang <math>\Delta ap_5 = \frac{0.60}{\sqrt{5-1}} \times \sqrt{5-1} = 0.6 \rightarrow \mathbf{0.08} (\Delta ap_5 - \Delta ap_4)</math></p>

TECHNISCHE DATEN

## ■ NC-PROGRAMM FÜR MODIFIZIERTE FLANKENZUSTELLUNG

### ● (Beispiel) M12×1.0 - 5 modifizierte Durchgänge 5°

Aussengewinde	Innengewinde
G00 Z = 5.0 X = 14.0	G00 Z = 5.0 X = 10.0
G92 U-4.34 Z-13.0 F1.0	G92 U4.34 Z-13.0 F1.0
G00 W-0.07	G00 W-0.07
G92 U-4.64 Z-13.0 F1.0	G92 U4.64 Z-13.0 F1.0
G00 W-0.06	G00 W-0.05
G92 U-4.88 Z-13.0 F1.0	G92 U4.84 Z-13.0 F1.0
G00 W-0.05	G00 W-0.04
G92 U-5.08 Z-13.0 F1.0	G92 U5.02 Z-13.0 F1.0
G00 W-0.03	G00 W-0.03
G92 U-5.20 Z-13.0 F1.0	G92 U5.14 Z-13.0 F1.0
G00	G00

## AUSWAHL DER SCHNITTDATEN

		Priorität					
		Standzeit	Schnittwiderstand	Oberflächengüte	Präzision	Spankontrolle	Bearbeitungszeit
Zustellung	Radialzustellung	○		○	○		○
	Flankenzustellung	(△ : modifiziert)	○	(△ : modifiziert)		○	
Schnitttiefe	Konst. Schnitttiefe					○	
	Schnittbereich	○	○	○	○		○

Hinweis 1) Standzeit und Oberflächengüte können bei Bearbeitung mit modifizierter Flankenzustellung verbessert werden. Die Spankontrolle kann durch eine höhere Schnitttiefe bei den letzten Durchgängen erhöht werden.

## SCHNITTIEFE UND ANZAHL DER DURCHGÄNGE

### ● Auswahl der Schnitttiefe und Anzahl der Durchgänge.

- Für die Gewindebearbeitung werden meistens vorinstallierte Gewindeprogramme genutzt bei welchen man nur noch die Gewindetiefe und die Schnitttiefe des ersten bzw. letzten Durchgangs setzen muss.
- Schnitttiefe und Anzahl der Durchgänge sind bei der radialen Zustellung leicht zu ändern. Somit können die entsprechenden Schnittbedingungen einfach ermittelt werden.

## EIGENSCHAFTEN UND VORTEILE DER MMT-SERIE

- Hohe Effizienz durch High-Speed-Bearbeitung und weniger Durchgänge.



## WEGE ZUR VERBESSERUNG

### ● Erhöhung der Standzeit

- Um Beschädigungen des Spitzenradius zu verhindern-  
*Empfohlene Gewindeschneidmethode - modifizierte Flankenzustellung*
- Um gleichmäßigen Verschleiß an den Schneidkanten zu erhalten-  
*Empfohlene Gewindeschneidmethode - radiale Zustellung*
- Um Kolkverschleiß an der Schneidkante zu verhindern-  
*Empfohlene Gewindeschneidmethode - Flankenzustellung*

### ● Schlechte Spanabfuhr

- Wechseln Sie die Zustellungsmethode. (Flanken- oder modifizierte Flankenzustellung.)
- Bei radialer Zustellung drehen Sie den Halter einfach um.
- Verwenden Sie eine Schnitttiefe von min. 0.2mm, um die Dicke der Späne zu erhöhen.

### ● Produktive Bearbeitung

- Erhöhen Sie die Schnittparameter.  
(Sofern Maschinenleistung dies zulässt)
- Begutachtung der WSP. Eine regelmäßige Kontrolle bietet Informationen, welche bestmögliche Bearbeitungswirtschaftlichkeit in Bezug auf Standzeit, Oberflächengüte und Schnittparameter erreicht werden können.
- Reduzierung der Durchgänge und Erhöhung der Schnitttiefe.

### ● Vibrationen

- Wechseln Sie die Zustellungsmethode. (Flanken- oder modifizierte Flankenzustellung.)
- Bei radialer Zustellung, reduzieren Sie die Schnitttiefe in den letzten Durchgängen.

### ● Oberflächengüte

- Der Schlichtdurchgang sollte (Idealerweise mit Vollprofil WSP) mit gleicher Schnitttiefe wie der letzte Durchgang durchgeführt werden.
- Es empfiehlt sich einen Leerschnitt vorzunehmen.

# WERKSTOFFVERGLEICHSTABELLE

## ■ C-STAHL

Deutschland		U.K.		Frankreich	Italien	Spanien	Schweden	Japan	USA	China
W-nr.	DIN	BS	EN	AFNOR	UNI	UNE	SS	JIS	AISI/SAE	GB
1.0038	RSt.37-2	4360 40 C	–	E 24-2 Ne	–	–	1311	STKM 12A STKM 12C	A570.36	15
1.0401	C15	080M15	–	CC12	C15, C16	F.111	1350	–	1015	15
1.0402	C22	050A20	2C	CC20	C20, C21	F.112	1450	–	1020	20
1.0715	9SMn28	230M07	1A	S250	CF9SMn28	F.2111 11SMn28	1912	SUM22	1213	Y15
1.0718	9SMnPb28	–	–	S250Pb	CF9SMnPb28	11SMnPb28	1914	SUM22L	12L13	–
1.0722	10SPb20	–	–	10PbF2	CF10Pb20	10SPb20	–	–	–	–
1.0736	9SMn36	240M07	1B	S300	CF9SMn36	12SMn35	–	–	1215	Y13
1.0737	9SMnPb36	–	–	S300Pb	CF9SMnPb36	12SMnP35	1926	–	12L14	–
1.1141	Ck15	080M15	32C	XC12	C16	C15K	1370	S15C	1015	15
1.1158	Ck25	–	–	–	–	–	–	S25C	1025	25
1.8900	StE380	4360 55 E	–	–	FeE390KG	–	2145	–	A572-60	–
1.0501	C35	060A35	–	CC35	C35	F.113	1550	–	1035	35
1.0503	C45	080M46	–	CC45	C45	F.114	1650	–	1045	45
1.0726	35S20	212M36	8M	35MF4	–	F210G	1957	–	1140	–
1.1157	40Mn4	150M36	15	35M5	–	–	–	–	1039	40Mn
1.1167	36Mn5	–	–	40M5	–	36Mn5	2120	SMn438(H)	1335	35Mn2
1.1170	28Mn6	150M28	14A	20M5	C28Mn	–	–	SCMn1	1330	30Mn
1.1183	Cf35	060A35	–	XC38TS	C36	–	1572	S35C	1035	35Mn
1.1191	Ck45	080M46	–	XC42	C45	C45K	1672	S45C	1045	Ck45
1.1213	Cf53	060A52	–	XC48TS	C53	–	1674	S50C	1050	50
1.0535	C55	070M55	9	–	C55	–	1655	–	1055	55
1.0601	C60	080A62	43D	CC55	C60	–	–	–	1060	60
1.1203	Ck55	070M55	–	XC55	C50	C55K	–	S55C	1055	55
1.1221	Ck60	080A62	43D	XC60	C60	–	1678	S58C	1060	60Mn
1.1274	Ck101	060A96	–	XC100	–	F.5117	1870	–	1095	–
1.1545	C105W1	BW1A	–	Y105	C36KU	F.5118	1880	SK3	W1	–
1.1545	C105W1	BW2	–	Y120	C120KU	F.515	2900	SUP4	W210	–

## ■ LEG. STAHL

Deutschland		U.K.		Frankreich	Italien	Spanien	Schweden	Japan	USA	China
W-nr.	DIN	BS	EN	AFNOR	UNI	UNE	SS	JIS	AISI/SAE	GB
1.0144	St.44.2	4360 43 C	–	E28-3	–	–	1412	SM400A, SM400B SM400C	A573-81	–
1.0570	St52-3	4360 50 B	–	E36-3	Fe52BFN Fe52CFN	–	2132	SM490A, SM490B SM490C	–	–
1.0841	St52-3	150M19	–	20MC5	Fe52	F.431	2172	–	5120	–
1.0904	55Si7	250A53	45	55S7	55Si8	56Si7	2085	–	9255	55Si2Mn
1.0961	60SiCr7	–	–	60SC7	60SiCr8	60SiCr8	–	–	9262	–
1.3505	100Cr6	534A99	31	100C6	100Cr6	F.131	2258	SUJ2	ASTM 52100	Gr15, 45G
1.5415	15Mo3	1501-240	–	15D3	16Mo3KW	16Mo3	2912	–	ASTM A204Gr.A	–
1.5423	16Mo5	1503-245-420	–	–	16Mo5	16Mo5	–	–	4520	–
1.5622	14Ni6	–	–	16N6	14Ni6	15Ni6	–	–	ASTM A350LF5	–
1.5662	X8Ni9	1501-509-510	–	–	X10Ni9	XBNI09	–	–	ASTM A353	–
1.5710	36NiCr6	640A35	111A	35NC6	–	–	–	SNC236	3135	–
1.5732	14NiCr10	–	–	14NC11	16NiCr11	15NiCr11	–	SNC415(H)	3415	–
1.5752	14NiCr14	655M13	36A	12NC15	–	–	–	SNC815(H)	3415, 3310	–
1.6523	21NiCrMo2	805M20	362	20NCD2	20NiCrMo2	20NiCrMo2	2506	SNCM220(H)	8620	–
1.6546	40NiCrMo22	311-Type 7	–	–	40NiCrMo2(KB)	40NiCrMo2	–	SNCM240	8740	–
1.6587	17CrNiMo6	820A16	–	18NCD6	–	14NiCrMo13	–	–	–	–
1.7015	15Cr3	523M15	–	12C3	–	–	–	SCr415(H)	5015	15Cr

Deutschland		U.K.		Frankreich	Italien	Spanien	Schweden	Japan	USA	China
W-nr.	DIN	BS	EN	AFNOR	UNI	UNE	SS	JIS	AISI/SAE	GB
1.7045	42Cr4	–	–	–	–	42Cr4	2245	SCr440	5140	40Cr
1.7176	55Cr3	527A60	48	55C3	–	–	–	SUP9(A)	5155	20CrMn
1.7262	15CrMo5	–	–	12CD4	–	12CrMo4	2216	SCM415(H)	–	–
1.7335	13CrMo4 4	1501-620Gr27	–	15CD3.5 15CD4.5	14CrMo45	14CrMo45	–	–	ASTM A182 F11, F12	–
1.7380	10CrMo910	1501-622 Gr31, 45	–	12CD9 12CD10	12CrMo9 12CrMo10	TU.H	2218	–	ASTM A182 F.22	–
1.7715	14MoV63	1503-660-440	–	–	–	13MoCrV6	–	–	–	–
1.8523	39CrMoV13 9	897M39	40C	–	36CrMoV12	–	–	–	–	–
1.6511	36CrNiMo4	816M40	110	40NCD3	38NiCrMo4(KB)	35NiCrMo4	–	–	9840	–
1.6582	34CrNiMo6	817M40	24	35NCD6	35NiCrMo6(KB)	–	2541	–	4340	40CrNiMoA
1.7033	34Cr4	530A32	18B	32C4	34Cr4(KB)	35Cr4	–	SCr430(H)	5132	35Cr
1.7035	41Cr4	530M40	18	42C4	41Cr4	42Cr4	–	SCr440(H)	5140	40Cr
1.7131	16MnCr5	(527M20)	–	16MC5	16MnCr5	16MnCr5	2511	–	5115	18CrMn
1.7218	25CrMo4	1717CDS110 708M20	–	25CD4	25CrMo4(KB)	55Cr3	2225	SCM420 SCM430	4130	30CrMn
1.7220	34CrMo4	708A37	19B	35CD4	35CrMo4	34CrMo4	2234	SCM432 SCCRM3	4137 4135	35CrMo
1.7223	41CrMo4	708M40	19A	42CD4TS	41CrMo4	42CrMo4	2244	SCM 440	4140 4142	40CrMoA
1.7225	42CrMo4	708M40	19A	42CD4	42CrMo4	42CrMo4	2244	SCM440(H)	4140	42CrMo 42CrMnMo
1.7361	32CrMo12	722M24	40B	30CD12	32CrMo12	F.124.A	2240	–	–	–
1.8159	50CrV4	735A50	47	50CV4	50CrV4	51CrV4	2230	SUP10	6150	50CrVA
1.8509	41CrAlMo7	905M39	41B	40CAD6 40CAD2	41CrAlMo7	41CrAlMo7	2940	–	–	–
1.2067	100Cr6	BL3	–	Y100C6	–	100Cr6	–	–	L3	CrV, 9SiCr
1.2419	105WCr6	–	–	105WC13	100WCr6 107WCr5KU	105WCr5	2140	SKS31 SKS2, SKS3	–	CrWMo
1.2713	55NiCrMoV6	BH224/5	–	55NCDV7	–	F.520.S	–	SKT4	L6	5CrNiMo
1.5662	X8Ni9	1501-509	–	–	X10Ni9	XBNI09	–	–	ASTM A353	–
1.5680	12Ni19	–	–	Z18N5	–	–	–	–	2515	–
1.6657	14NiCrMo134	832M13	36C	–	15NiCrMo13	14NiCrMo131	–	–	–	–
1.2080	X210Cr12	BD3	–	Z200C12	X210Cr13KU X250Cr12KU	X210Cr12	–	SKD1	D3 ASTM D3	Cr12
1.2601	X153CrMoV12	BD2	–	–	X160CrMoV12	–	–	SKD11	D2	Cr12MoV
1.2363	X100CrMoV5	BA2	–	Z100CDV5	X100CrMoV5	F.5227	2260	SKD12	A2	Cr5Mo1V
1.2344	X40CrMoV51 X40CrMoV51	BH13	–	Z40CDV5	X35CrMoV05KU X40CrMoV51KU	X40CrMoV5	2242	SKD61	H13 ASTM H13	40CrMoV5
1.2436	X210CrW12	–	–	–	X215CrW121KU	X210CrW12	2312	SKD2	–	–
1.2542	45WCrV7	BS1	–	–	45WCrV8KU	45WCrSi8	2710	–	S1	–
1.2581	X30WCrV93	BH21	–	Z30WCV9	X28W09KU	X30WCrV9	–	SKD5	H21	30WCrV9
1.2601	X165CrMoV12	–	–	–	X165CrMoV12KU	X160CrMoV12	2310	–	–	–
1.2833	100V1	BW2	–	Y1105V	–	–	–	SKS43	W210	V
1.3255	S 18-1-2-5	BT4	–	Z80WKCV	X78WCo1805KU	HS18-1-1-5	–	SKH3	T4	W18Cr4VCo5
1.3355	S 18-0-1	BT1	–	Z80WCV	X75W18KU	HS18-0-1	–	SKH2	T1	–
1.3401	G-X120Mn12	Z120M12	–	Z120M12	XG120Mn12	X120MN12	–	SCMnH/1	–	–
1.4718	X45CrSi93	401S45	52	Z45CS9	X45CrSi8	F.322	–	SUH1	HW3	X45CrSi93
1.3343	S6-5-2	4959BA2	–	Z40CSD10	15NiCrMo13	–	2715	SUH3	D3	–
1.3343	S6/5/2	BM2	–	Z85WDCV	HS6-5-2-2	F.5603	2722	SKH9, SKH51	M2	–
1.3348	S 2-9-2	–	–	–	HS2-9-2	HS2-9-2	2782	–	M7	–
1.3243	S6/5/2/5	BM35	–	6-5-2-5	HS6-5-2-5	F.5613	2723	SKH55	M35	–



# WERKSTOFFVERGLEICHSTABELLE

## ■ ROSTFREIER STAHL (FERRITISCH, MARTENSITISCH)

Deutschland		U.K.		Frankreich	Italien	Spanien	Schweden	Japan	USA	China
W-nr.	DIN	BS	EN	AFNOR	UNI	UNE	SS	JIS	AISI/SAE	GB
1.4000	X7Cr13	403S17	–	Z6C13	X6Cr13	F.3110	2301	SUS403	403	OCr13 1Cr12
1.4001	X7Cr14	–	–	–	–	F.8401	–	–	–	–
1.4005	X12CrS13	416S21	–	Z11CF13	X12CrS13	F.3411	2380	SUS416	416	–
1.4006	X10Cr13	410S21	56A	Z10C14	X12Cr13	F.3401	2302	SUS410	410	1Cr13
1.4016	X8Cr17	430S15	60	Z8C17	X8Cr17	F.3113	2320	SUS430	430	1Cr17
1.4027	G-X20Cr14	420C29	56B	Z20C13M	–	–	–	SCS2	–	–
1.4034	X46Cr13	420S45	56D	Z40CM Z38C13M	X40Cr14	F.3405	2304	SUS420J2	–	4Cr13
1.4003	–	405S17	–	Z8CA12	X6CrAl13	–	–	–	405	–
1.4021	–	420S37	–	Z8CA12	X20Cr13	–	2303	–	420	–
1.4057	X22CrNi17	431S29	57	Z15CNi6.02	X16CrNi16	F.3427	2321	SUS431	431	1Cr17Ni2
1.4104	X12CrMoS17	–	–	Z10CF17	X10CrS17	F.3117	2383	SUS430F	430F	Y1Cr17
1.4113	X6CrMo17	434S17	–	Z8CD17.01	X8CrMo17	–	2325	SUS434	434	1Cr17Mo
1.4313	X5CrNi134	425C11	–	Z4CND13.4M	(G)X6CrNi304	–	2385	SCS5	CA6-NM	–
1.4724	X10CrA113	403S17	–	Z10C13	X10CrA112	F.311	–	SUS405	405	OCr13Al
1.4742	X10CrA118	430S15	60	Z10CAS18	X8Cr17	F.3113	–	SUS430	430	Cr17
1.4747	X80CrNiSi20	443S65	59	Z80CSN20.02	X80CrSiNi20	F.320B	–	SUH4	HNV6	–
1.4762	X10CrA124	–	–	Z10CAS24	X16Cr26	–	2322	SUH446	446	2Cr25N
1.4871	X53CrMnNiN219	349S54	–	Z52CMN21.09	X53CrMnNiN219	–	–	SUH35	EV8	5Cr2Mn9Ni4N
1.4521	X1CrMoTi182	–	–	–	–	–	2326	–	S44400	–
1.4922	X20CrMoV12-1	–	–	–	X20CrMoNi1201	–	2317	–	–	–
1.4542	–	–	–	Z7CNU17-04	–	–	–	–	630	–

## ■ ROSTFREIER STAHL (AUSTENITISCH)

Deutschland		U.K.		Frankreich	Italien	Spanien	Schweden	Japan	USA	China
W-nr.	DIN	BS	EN	AFNOR	UNI	UNE	SS	JIS	AISI/SAE	GB
1.4306	X2CrNi1911	304S11	–	Z2CN18.10	X2CrNi18.11	–	2352	SUS304L	304L	OCr19Ni10
1.4350	X5CrNi189	304S11	58E	Z6CN18.09	X5CrNi1810	F.3551 F.3541 F.3504	2332	SUS304	304	OCr18Ni9
1.4305	X12CrNiS188	303S21	58M	Z10CNF18.09	X10CrNiS18.09	F.3508	2346	SUS303	303	1Cr18Ni9MoZr
–	–	304C12	–	Z3CN19.10	–	–	2333	SUS304L	–	–
1.4306	X2CrNi189	304S12	–	Z2CrNi1810	X2CrNi18.11	F.3503	2352	SCS19	304L	–
1.4310	X12CrNi177	–	–	Z12CN17.07	X12CrNi1707	F.3517	2331	SUS301	301	Cr17Ni7
1.4311	X2CrNiN1810	304S62	–	Z2CN18.10	–	–	2371	SUS304LN	304LN	–
1.4401	X5CrNiMo1810	316S16	58J	Z6CND17.11	X5CrNiMo1712	F.3543	2347	SUS316	316	OCr17Ni11Mo2
1.4308	G-X6CrNi189	304C15	–	Z6CN18.10M	–	–	–	SCS13	–	–
1.4408	G-X6CrNiMo1810	316C16	–	–	–	F.8414	–	SCS14	–	–
1.4581	G-X5CrNiMoNb1810	318C17	–	Z4CNDNb1812M	XG8CrNiMo1811	–	–	SCS22	–	–
1.4429	X2CrNiMoN1813	–	–	Z2CND17.13	–	–	2375	SUS316LN	316LN	OCr17Ni13Mo
1.4404	–	316S13	–	Z2CND17.12	X2CrNiMo1712	–	2348	–	316L	–
1.4435	X2CrNiMo1812	316S13	–	Z2CND17.12	X2CrNiMo1712	–	2353	SCS16 SUS316L	316L	OCr27Ni12Mo3
1.4436	–	316S13	–	Z6CND18-12-03	X8CrNiMo1713	–	2343, 2347	–	316	–
1.4438	X2CrNiMo1816	317S12	–	Z2CND19.15	X2CrNiMo1816	–	2367	SUS317L	317L	OCr19Ni13Mo
1.4539	X1NiCrMo	–	–	Z6CNT18.10	–	–	2562	–	UNS V 0890A	–
1.4541	X10CrNiTi189	321S12	58B	Z6CNT18.10	X6CrNiTi1811	F.3553 F.3523	2337	SUS321	321	1Cr18Ni9Ti
1.4550	X10CrNiNb189	347S17	58F	Z6CNNb18.10	X6CrNiNb1811	F.3552 F.3524	2338	SUS347	347	1Cr18Ni11Nb
1.4571	X10CrNiMoTi1810	320S17	58J	Z6CNDT17.12	X6CrNiMoTi1712	F.3535	2350	–	316Ti	Cr18Ni12Mo2T
1.4583	X10CrNiMoNb1812	–	–	Z6CNDNb1713B	X6CrNiMoNb1713	–	–	–	318	Cr17Ni12Mo3Mb

Deutschland		U.K.		Frankreich	Italien	Spanien	Schweden	Japan	USA	China
W-nr.	DIN	BS	EN	AFNOR	UNI	UNE	SS	JIS	AISI/SAE	GB
1.4828	X15CrNiSi2012	309S24	–	Z15CNS20.12	X6CrNi2520	–	–	SUH309	309	1Cr23Ni13
1.4845	X12CrNi2521	310S24	–	Z12CN2520	X6CrNi2520	F.331	2361	SUH310	310S	OCr25Ni20
1.4406	X10CrNi18.08	–	58C	Z1NCDU25.20	–	F.8414	2370	SCS17	308	–
1.4418	X4CrNiMo165	–	–	Z6CND16-04-01	–	–	–	–	–	–
1.4568	–	316S111	–	Z8CNA17-07	X2CrNiMo1712	–	–	–	17-7PH	–
1.4504	–	–	–	–	–	–	–	–	–	–
1.4563	–	–	–	Z1NCDU31-27-03 Z1CNDU20-18-06AZ	–	–	2584 2378	–	NO8028 S31254	–
1.4878	X12CrNiTi189	321S32	58B, 58C	Z6CNT18.12B	X6CrNiTi18.11	F.3523	–	SUS321	321	1Cr18Ni9Ti

## ■ HITZEBESTÄNDIGE STÄHLE

Deutschland		U.K.		Frankreich	Italien	Spanien	Schweden	Japan	USA	China
W-nr.	DIN	BS	EN	AFNOR	UNI	UNE	SS	JIS	AISI/SAE	GB
1.4864	X12NiCrSi3616	–	–	Z12NCS35.16	–	–	–	SUH330	330	–
1.4865	G-X40NiCrSi3818	330C11	–	–	XG50NiCr3919	–	–	SCH15	HT, HT 50	–

## ■ GRAUGUSS

Deutschland		U.K.		Frankreich	Italien	Spanien	Schweden	Japan	USA	China
W-nr.	DIN	BS	EN	AFNOR	UNI	UNE	SS	JIS	AISI/SAE	GB
–	–	–	–	–	–	–	0100	–	–	–
–	GG 10	–	–	Ft 10 D	–	–	0110	FC100	No 20 B	–
0.6015	GG 15	Grade 150	–	Ft 15 D	G15	FG15	0115	FC150	No 25 B	HT150
0.6020	GG 20	Grade 220	–	Ft 20 D	G20	–	0120	FC200	No 30 B	HT200
0.6025	GG 25	Grade 260	–	Ft 25 D	G25	FG25	0125	FC250	No 35 B	HT250
–	–	–	–	–	–	–	–	–	No 40 B	–
0.6030	GG 30	Grade 300	–	Ft 30 D	G30	FG30	0130	FC300	No 45 B	HT300
0.6035	GG 35	Grade 350	–	Ft 35 D	G35	FG35	0135	FC350	No 50 B	HT350
0.6040	GG 40	Grade 400	–	Ft 40 D	–	–	0140	–	No 55 B	HT400
0.6660	GGL NiCr202	L-NiCuCr202	–	L-NC 202	–	–	0523	–	A436 Type 2	–

## ■ DUKTILER GUSS

Deutschland		U.K.		Frankreich	Italien	Spanien	Schweden	Japan	USA	China
W-nr.	DIN	BS	EN	AFNOR	UNI	UNE	SS	JIS	AISI/SAE	GB
0.7040	GGG 40	SNG 420/12	–	FCS 400-12	GS 370-17	FGE 38-17	07 17-02	FCD400	60-40-18	QT400-18
–	GGG 40.3	SNG 370/17	–	FGS 370-17	–	–	07 17-12	–	–	–
0.7033	GGG 35.3	–	–	–	–	–	07 17-15	–	–	–
0.7050	GGG 50	SNG 500/7	–	FGS 500-7	GS 500	FGE 50-7	07 27-02	FCD500	80-55-06	QT500-7
0.7660	GGG NiCr202	Grade S6	–	S-NC202	–	–	07 76	–	A43D2	–
–	GGG NiMn137	L-NiMn 137	–	L-MN 137	–	–	07 72	–	–	–
–	GGG 60	SNG 600/3	–	FGS 600-3	–	–	07 32-03	FCD600	–	QT600-3
0.7070	GGG 70	SNG 700/2	–	FGS 700-2	GS 700-2	FGS 70-2	07 37-01	FCD700	100-70-03	QT700-18

## ■ TEMPERGUSS

Deutschland		U.K.		Frankreich	Italien	Spanien	Schweden	Japan	USA	China
W-nr.	DIN	BS	EN	AFNOR	UNI	UNE	SS	JIS	AISI/SAE	GB
–	–	8 290/6	–	MN 32-8	–	–	08 14	FCMB310	–	–
–	GTS-35	B 340/12	–	MN 35-10	–	–	08 15	FCMW330	32510	–
0.8145	GTS-45	P 440/7	–	Mn 450	GMN45	–	08 52	FCMW370	40010	–
0.8155	GTS-55	P 510/4	–	MP 50-5	GMN55	–	08 54	FCMP490	50005	–
–	GTS-65	P 570/3	–	MP 60-3	–	–	08 58	FCMP540	70003	–
0.8165	GTS-65-02	P 570/3	–	Mn 650-3	GMN 65	–	08 56	FCMP590	A220-70003	–
–	GTS-70-02	P 690/2	–	Mn 700-2	GMN 70	–	08 62	FCMP690	A220-80002	–

# OBERFLÄCHENRAUHIGKEIT

## OBERFLÄCHENRAUHIGKEIT

(von JIS B 0601-1994)

Typ	Symbol	Berechnungsmethode	Meßaufnahme (Abbildung)
Mittlere Rauhtiefe	Ra	<p>Der Mittelrauhwert Ra ist der arithmetische Mittelwert der absoluten Beträge der Abstände y des Rauheitsprofils von der Mittellinie innerhalb der Messtrecke. Dies ist gleichbedeutend mit der Höhe des Rechtecks, dessen Länge gleich der Gesamtstrecke l ist und das flächengleich mit der Summe der zwischen dem Rauheitsprofil und der Mittellinie eingeschlossenen Fläche ist <math>y=f</math></p> $Ra = \frac{1}{l} \int_0^l  f(x)  dx$	
Maximale Rauhtiefe	Rz	<p>Die maximale Rauhtiefe Ry ist die größte der auf der Gesamtmeßstrecke l vorkommenden Einzelrauhtiefen. Ry wird auch in (µm) Mikrometer angegeben. Hinweis: Um Rz herauszufinden, wird ein Anteil ohne außergewöhnliche Höhen und Tiefen als Stichprobenlänge ausgewählt und als Schwachstelle betrachtet.</p> $Rz = Rp + Rv$	
Gemittelte Rauhtiefe	RzJIS	<p>Die gemittelte Rauhtiefe Rz ist das arithmetische Mittel aus den Einzelrauhtiefen fünf aufeinander grenzender Einzelmessstrecken gleicher Länge. Rz wird ebenfalls in (µm) angegeben.</p> $Rz_{JIS} = \frac{(Yp1+Yp2+Yp3+Yp4+Yp5) + (Yv1+Yv2+Yv3+Yv4+Yv5)}{5}$	<p><i>Yp1, Yp2, Yp3, Yp4, Yp5</i> : Die 5 tiefsten Meßpunkte einer ausgewählten Strecke entsprechend der Länge l. <i>Yv1, Yv2, Yv3, Yv4, Yv5</i> : Die 5 tiefsten Meßpunkte einer ausgewählten Strecke entsprechend der Länge l.</p>

### ZUORDNUNG DER GEMITTELTEN WERTE (Ra) ZU DEN OBERFLÄCHENANGABEN

Mittlere Rauhtiefe Ra		Maximale Rauhtiefe Rz	Gemittelte Rauhtiefe RzJIS	Prüflänge für Rz • RzJIS l (mm)	Oberflächenzeichen
Standard	Richtwerte λc (mm)	Standard			
0.012 a	0.08	0.05 s	0.05 z	0.08	▽▽▽▽
0.025 a		0.1 s	0.1 z		
0.05 a	0.25	0.2 s	0.2 z	0.25	
0.1 a		0.4 s	0.4 z		
0.2 a		0.8 s	0.8 z		
0.4 a	0.8	1.6 s	1.6 z	0.8	▽▽▽
0.8 a		3.2 s	3.2 z		
1.6 a		6.3 s	6.3 z		
3.2 a		12.5 s	12.5 z		
6.3 a	2.5	25 s	25 z	2.5	▽▽
12.5 a		50 s	50 z		
25 a	8	100 s	100 z	8	▽
50 a		200 s	200 z		
100 a		400 s	400 z		

Hinweis 1) Die Zuordnung dieser 3 Darstellungen ist zweckdienlich und nicht exakt.

Hinweis 2) Ra: Die Bewertungslänge von Rz und RzJIS ist der Abschaltwert und die Stichprobenlänge multipliziert x 5.

# HÄRTEVERGLEICHSTABELLE

## VERGLEICHSTABELLEN HÄRTE VON STAHL

Brinell Härte (HB) 10mm Kugel, Last: 3000kgf		Vickers Härte	Rockwell Härte				Shore Härte	Streckgrenze (ca.) MPa	Brinell Härte (HB) 10mm Kugel, Last: 3000kgf		Vickers Härte	Rockwell Härte				Shore Härte	Streckgrenze (ca.) MPa
Standard Kugel	Hartmetallkugel		A Skala, Last: 60kgf Diamantkegel	B Skala, Last: 100kgf 1/16" Kugel	C Skala, Last: 150kgf Diamantkegel	D Skala, Last: 100kgf Diamantkegel			Standard Kugel	Hartmetallkugel		A Skala, Last: 60kgf Diamantkegel	B Skala, Last: 100kgf 1/16" Kugel	C Skala, Last: 150kgf Diamantkegel	D Skala, Last: 100kgf Diamantkegel		
		(HV)	(HRA)	(HRB)	(HRC)	(HRD)	(HS)			(HV)	(HRA)	(HRB)	(HRC)	(HRD)	(HS)		
—	—	940	85.6	—	68.0	76.9	97	—	429	429	455	73.4	—	45.7	59.7	61	1510
—	—	920	85.3	—	67.5	76.5	96	—	415	415	440	72.8	—	44.5	58.8	59	1460
—	—	900	85.0	—	67.0	76.1	95	—	401	401	425	72.0	—	43.1	57.8	58	1390
—	(767)	880	84.7	—	66.4	75.7	93	—	388	388	410	71.4	—	41.8	56.8	56	1330
—	(757)	860	84.4	—	65.9	75.3	92	—	375	375	396	70.6	—	40.4	55.7	54	1270
—	(745)	840	84.1	—	65.3	74.8	91	—	363	363	383	70.0	—	39.1	54.6	52	1220
—	(733)	820	83.8	—	64.7	74.3	90	—	352	352	372	69.3	(110.0)	37.9	53.8	51	1180
—	(722)	800	83.4	—	64.0	73.8	88	—	341	341	360	68.7	(109.0)	36.6	52.8	50	1130
—	(712)	—	—	—	—	—	—	—	331	331	350	68.1	(108.5)	35.5	51.9	48	1095
—	(710)	780	83.0	—	63.3	73.3	87	—	321	321	339	67.5	(108.0)	34.3	51.0	47	1060
—	(698)	760	82.6	—	62.5	72.6	86	—	—	—	—	—	—	—	—	—	—
—	(684)	740	82.2	—	61.8	72.1	—	—	311	311	328	66.9	(107.5)	33.1	50.0	46	1025
—	(682)	737	82.2	—	61.7	72.0	84	—	302	302	319	66.3	(107.0)	32.1	49.3	45	1005
—	(670)	720	81.8	—	61.0	71.5	83	—	293	293	309	65.7	(106.0)	30.9	48.3	43	970
—	(656)	700	81.3	—	60.1	70.8	—	—	285	285	301	65.3	(105.5)	29.9	47.6	—	950
—	(653)	697	81.2	—	60.0	70.7	81	—	277	277	292	64.6	(104.5)	28.8	46.7	41	925
—	(647)	690	81.1	—	59.7	70.5	—	—	269	269	284	64.1	(104.0)	27.6	45.9	40	895
—	(638)	680	80.8	—	59.2	70.1	80	—	262	262	276	63.6	(103.0)	26.6	45.0	39	875
—	630	670	80.6	—	58.8	69.8	—	—	255	255	269	63.0	(102.0)	25.4	44.2	38	850
—	627	667	80.5	—	58.7	69.7	79	—	248	248	261	62.5	(101.0)	24.2	43.2	37	825
—	—	677	80.7	—	59.1	70.0	—	—	241	241	253	61.8	100	22.8	42.0	36	800
—	601	640	79.8	—	57.3	68.7	77	—	235	235	247	61.4	99.0	21.7	41.4	35	785
—	—	640	79.8	—	57.3	68.7	—	—	229	229	241	60.8	98.2	20.5	40.5	34	765
—	578	615	79.1	—	56.0	67.7	75	—	223	223	234	—	97.3	(18.8)	—	—	—
—	—	607	78.8	—	55.6	67.4	—	—	217	217	228	—	96.4	(17.5)	—	33	725
—	555	591	78.4	—	54.7	66.7	73	2055	212	212	222	—	95.5	(16.0)	—	—	705
—	—	579	78.0	—	54.0	66.1	—	2015	207	207	218	—	94.6	(15.2)	—	32	690
—	534	569	77.8	—	53.5	65.8	71	1985	201	201	212	—	93.8	(13.8)	—	31	675
—	—	533	77.1	—	52.5	65.0	—	1915	197	197	207	—	92.8	(12.7)	—	30	655
—	514	547	76.9	—	52.1	64.7	70	1890	192	192	202	—	91.9	(11.5)	—	29	640
(495)	—	539	76.7	—	51.6	64.3	—	1855	187	187	196	—	90.7	(10.0)	—	—	620
—	495	528	76.3	—	51.0	63.8	68	1820	183	183	192	—	90.0	(9.0)	—	28	615
(477)	—	516	75.9	—	50.3	63.2	—	1780	179	179	188	—	89.0	(8.0)	—	27	600
—	—	508	75.6	—	49.6	62.7	—	1740	174	174	182	—	87.8	(6.4)	—	—	585
—	477	508	75.6	—	49.6	62.7	66	1740	170	170	178	—	86.8	(5.4)	—	26	570
(461)	—	495	75.1	—	48.8	61.9	—	1680	167	167	175	—	86.0	(4.4)	—	—	560
—	—	491	74.9	—	48.5	61.7	—	1670	163	163	171	—	85.0	(3.3)	—	25	545
—	461	491	74.9	—	48.5	61.7	65	1670	156	156	163	—	82.9	(0.9)	—	—	525
—	—	474	74.3	—	47.2	61.0	—	1595	149	149	156	—	80.8	—	—	23	505
—	—	472	74.2	—	47.1	60.8	—	1585	143	143	150	—	78.7	—	—	22	490
—	444	472	74.2	—	47.1	60.8	63	1585	137	137	143	—	76.4	—	—	21	460
—	—	474	74.3	—	47.2	61.0	—	1595	131	131	137	—	74.0	—	—	—	450
—	—	472	74.2	—	47.1	60.8	—	1585	126	126	132	—	72.0	—	—	20	435
—	444	472	74.2	—	47.1	60.8	63	1585	121	121	127	—	69.8	—	—	19	415
—	—	472	74.2	—	47.1	60.8	—	1585	116	116	122	—	67.6	—	—	18	400
—	—	472	74.2	—	47.1	60.8	63	1585	111	111	117	—	65.7	—	—	15	385

Hinweis 1) Die obige Tabelle ist vergleichbar mit den Angaben aus dem AMS Metallhandbuch mit genäherten Werten für Streckgrenze und Brinellhärte über einer empfohlenen Strecke.

Hinweis 2) 1MPa=1N/mm<sup>2</sup>

Hinweis 3) Werte in Klammern werden selten benutzt und stehen nur als Ergänzung in der Tabelle.  
Diese Tabelle ist aus dem JIS Handbuch für Stahl entnommen.

# TOLERANZANGABEN FÜR INNENDURCHMESSER (BOHRUNG)

Klassifizierung der Standard Abmessungen (mm)		Baureihe des geometrischen Toleranzbereichs der Löcher															
>	≤	B10	C9	C10	D8	D9	D10	E7	E8	E9	F6	F7	F8	G6	G7	H6	H7
—	3	+180	+85	+100	+34	+45	+60	+24	+28	+39	+12	+16	+20	+8	+12	+6	+10
		+140	+60	+60	+20	+20	+20	+14	+14	+14	+6	+6	+6	+2	+2	0	0
3	6	+188	+100	+118	+48	+60	+78	+32	+38	+50	+18	+22	+28	+12	+16	+8	+12
		+140	+70	+70	+30	+30	+30	+20	+20	+20	+10	+10	+10	+4	+4	0	0
6	10	+208	+116	+138	+62	+76	+98	+40	+47	+61	+22	+28	+35	+14	+20	+9	+15
		+150	+80	+80	+40	+40	+40	+25	+25	+25	+13	+13	+13	+5	+5	0	0
10	14	+220	+138	+165	+77	+93	+120	+50	+59	+75	+27	+34	+43	+17	+24	+11	+18
		+150	+95	+95	+50	+50	+50	+32	+32	+32	+16	+16	+16	+6	+6	0	0
14	18	+244	+162	+194	+98	+117	+149	+61	+73	+92	+33	+41	+53	+20	+28	+13	+21
		+160	+110	+110	+65	+65	+65	+40	+40	+40	+20	+20	+20	+7	+7	0	0
18	24	+270	+182	+220	+119	+142	+180	+75	+89	+112	+41	+50	+64	+25	+34	+16	+25
		+170	+120	+120	+80	+80	+80	+50	+50	+50	+25	+25	+25	+9	+9	0	0
30	40	+280	+192	+230	+146	+174	+220	+90	+106	+134	+49	+60	+76	+29	+40	+19	+30
		+180	+130	+130	+100	+100	+100	+60	+60	+60	+30	+30	+30	+10	+10	0	0
40	50	+310	+214	+260	+174	+207	+260	+107	+126	+159	+58	+71	+90	+34	+47	+22	+35
		+190	+140	+140	+120	+120	+120	+72	+72	+72	+36	+36	+36	+12	+12	0	0
50	65	+320	+224	+270	+208	+245	+305	+125	+148	+185	+68	+83	+106	+39	+54	+25	+40
		+200	+150	+150	+145	+145	+145	+85	+85	+85	+43	+43	+43	+14	+14	0	0
65	80	+360	+257	+310	+242	+285	+355	+146	+172	+215	+79	+96	+122	+44	+61	+29	+46
		+220	+170	+170	+170	+170	+170	+100	+100	+100	+50	+50	+50	+15	+15	0	0
80	100	+380	+267	+320	+271	+320	+400	+162	+191	+240	+88	+108	+137	+49	+69	+32	+52
		+240	+180	+180	+190	+190	+190	+110	+110	+110	+56	+56	+56	+17	+17	0	0
100	120	+420	+300	+360	+299	+350	+440	+182	+214	+265	+98	+119	+151	+54	+75	+36	+57
		+260	+200	+200	+210	+210	+210	+125	+125	+125	+62	+62	+62	+18	+18	0	0
120	140	+440	+310	+370	+327	+385	+480	+198	+232	+290	+108	+131	+165	+60	+83	+40	+63
		+280	+210	+210	+230	+230	+230	+135	+135	+135	+68	+68	+68	+20	+20	0	0
140	160	+470	+330	+390	+355	+425	+327	+385	+480	+198	+232	+290	+108	+131	+165	+60	+83
		+310	+230	+230	+240	+240	+240	+242	+285	+355	+146	+172	+215	+79	+96	+122	+44
160	180	+525	+355	+425	+242	+285	+355	+146	+172	+215	+79	+96	+122	+44	+61	+29	+46
		+340	+240	+240	+170	+170	+170	+100	+100	+100	+50	+50	+50	+15	+15	0	0
180	200	+565	+375	+445	+271	+320	+400	+162	+191	+240	+88	+108	+137	+49	+69	+32	+52
		+380	+260	+260	+190	+190	+190	+110	+110	+110	+56	+56	+56	+17	+17	0	0
200	225	+605	+395	+465	+299	+350	+440	+182	+214	+265	+98	+119	+151	+54	+75	+36	+57
		+420	+280	+280	+210	+210	+210	+125	+125	+125	+62	+62	+62	+18	+18	0	0
225	250	+690	+430	+510	+327	+385	+480	+198	+232	+290	+108	+131	+165	+60	+83	+40	+63
		+480	+300	+300	+230	+230	+230	+135	+135	+135	+68	+68	+68	+20	+20	0	0
250	280	+750	+460	+540	+355	+425	+327	+385	+480	+198	+232	+290	+108	+131	+165	+60	+83
		+540	+330	+330	+242	+285	+355	+146	+172	+215	+79	+96	+122	+44	+61	+29	+46
280	315	+830	+500	+590	+242	+285	+355	+146	+172	+215	+79	+96	+122	+44	+61	+29	+46
		+600	+360	+360	+170	+170	+170	+100	+100	+100	+50	+50	+50	+15	+15	0	0
315	355	+910	+540	+630	+299	+350	+440	+182	+214	+265	+98	+119	+151	+54	+75	+36	+57
		+680	+400	+400	+210	+210	+210	+125	+125	+125	+62	+62	+62	+18	+18	0	0
355	400	+1010	+595	+690	+327	+385	+480	+198	+232	+290	+108	+131	+165	+60	+83	+40	+63
		+760	+440	+440	+230	+230	+230	+135	+135	+135	+68	+68	+68	+20	+20	0	0
400	450	+1090	+635	+730	+355	+425	+327	+385	+480	+198	+232	+290	+108	+131	+165	+60	+83
		+840	+480	+480	+242	+285	+355	+146	+172	+215	+79	+96	+122	+44	+61	+29	+46

Hinweis 1) Aufgezeigte Werte im oberen Teil der jeweiligen Linien weisen überdimensionale Toleranzen auf, während die Werte in dem unteren Teil niedrige Toleranzangaben aufweisen.

Baureihe des geometrischen Toleranzbereichs der Löcher

H8	H9	H10	JS6	JS7	K6	K7	M6	M7	N6	N7	P6	P7	R7	S7	T7	U7	X7
+14 0	+25 0	+40 0	$\pm 3$	$\pm 5$	0 -6	0 -10	-2 -8	-2 -12	-4 -10	-4 -14	-6 -12	-6 -16	-10 -20	-14 -24	-	-18 -28	-20 -30
+18 0	+30 0	+48 0	$\pm 4$	$\pm 6$	+2 -6	+3 -9	-1 -9	0 -12	-5 -13	-4 -16	-9 -17	-8 -20	-11 -23	-15 -27	-	-19 -31	-24 -36
+22 0	+36 0	+58 0	$\pm 4.5$	$\pm 7$	+2 -7	+5 -10	-3 -12	0 -15	-7 -16	-4 -19	-12 -21	-9 -24	-13 -28	-17 -32	-	-22 -37	-28 -43
+27 0	+43 0	+70 0	$\pm 5.5$	$\pm 9$	+2 -9	+6 -12	-4 -15	0 -18	-9 -20	-5 -23	-15 -26	-11 -29	-16 -34	-21 -39	-	-26 -44	-33 -51 -56
+33 0	+52 0	+84 0	$\pm 6.5$	$\pm 10$	+2 -11	+6 -15	-4 -17	0 -21	-11 -24	-7 -28	-18 -31	-14 -35	-20 -41	-27 -48	-	-33 -54	-46 -67 -77
+39 0	+62 0	+100 0	$\pm 8$	$\pm 12$	+3 -13	+7 -18	-4 -20	0 -25	-12 -28	-8 -33	-21 -37	-17 -42	-25 -50	-34 -59	-39 -64 -70	-51 -76 -86	-
+46 0	+74 0	+120 0	$\pm 9.5$	$\pm 15$	+4 -15	+9 -21	-5 -24	0 -30	-14 -33	-9 -39	-26 -45	-21 -51	-30 -60 -62	-42 -72 -78	-55 -85 -94	-76 -106 -121	-
+54 0	+87 0	+140 0	$\pm 11$	$\pm 17$	+4 -18	+10 -25	-6 -28	0 -35	-16 -38	-10 -45	-30 -52	-24 -59	-38 -73 -81	-58 -93 -101	-78 -113 -126	-111 -146 -166	-
+63 0	+100 0	+160 0	$\pm 12.5$	$\pm 20$	+4 -21	+12 -28	-8 -33	0 -40	-20 -45	-12 -52	-36 -61	-28 -68	-48 -88 -90 -93	-77 -117 -125 -133	-107 -147 -159 -171	-	-
+72 0	+115 0	+185 0	$\pm 14.5$	$\pm 23$	+5 -24	+13 -33	-8 -37	0 -46	-22 -51	-14 -60	-41 -70	-33 -79	-60 -106 -109 -113	-105 -151 -159 -169	-	-	-
+81 0	+130 0	+210 0	$\pm 16$	$\pm 26$	+5 -27	+16 -36	-9 -41	0 -52	-25 -57	-14 -66	-47 -79	-36 -88	-74 -126 -78 -130	-	-	-	-
+89 0	+140 0	+230 0	$\pm 18$	$\pm 28$	+7 -29	+17 -40	-10 -46	0 -57	-26 -62	-16 -73	-51 -87	-41 -98	-87 -144 -93 -150	-	-	-	-
+97 0	+155 0	+250 0	$\pm 20$	$\pm 31$	+8 -32	+18 -45	-10 -50	0 -63	-27 -67	-17 -80	-55 -95	-45 -108	-103 -166 -109 -172	-	-	-	-

# ISO-PASSUNGEN EINHEITSWELLE

Klassifizierung der Standard Abmessungen (mm)		Baureihe des geometrischen Toleranzbereichs der Schäfte														
>	≤	b9	c9	d8	d9	e7	e8	e9	f6	f7	f8	g5	g6	h5	h6	h7
-	3	-140	-60	-20	-20	-14	-14	-14	-6	-6	-6	-2	-2	0	0	0
		-165	-85	-34	-45	-24	-28	-39	-12	-16	-20	-6	-8	-4	-6	-10
3	6	-140	-70	-30	-30	-20	-20	-20	-10	-10	-10	-4	-4	0	0	0
		-170	-100	-48	-60	-32	-38	-50	-18	-22	-28	-9	-12	-5	-8	-12
6	10	-150	-80	-40	-40	-25	-25	-25	-13	-13	-13	-5	-5	0	0	0
		-186	-116	-62	-76	-40	-47	-61	-22	-28	-35	-11	-14	-6	-9	-15
10	14	-150	-95	-50	-50	-32	-32	-32	-16	-16	-16	-6	-6	0	0	0
		-193	-138	-77	-93	-50	-59	-75	-27	-34	-43	-14	-17	-8	-11	-18
14	18	-150	-95	-50	-50	-32	-32	-32	-16	-16	-16	-6	-6	0	0	0
		-193	-138	-77	-93	-50	-59	-75	-27	-34	-43	-14	-17	-8	-11	-18
18	24	-160	-110	-65	-65	-40	-40	-40	-20	-20	-20	-7	-7	0	0	0
		-212	-162	-98	-117	-61	-73	-92	-33	-41	-53	-16	-20	-9	-13	-21
24	30	-160	-110	-65	-65	-40	-40	-40	-20	-20	-20	-7	-7	0	0	0
		-212	-162	-98	-117	-61	-73	-92	-33	-41	-53	-16	-20	-9	-13	-21
30	40	-170	-120	-80	-80	-50	-50	-50	-25	-25	-25	-9	-9	0	0	0
		-232	-182	-119	-142	-75	-89	-112	-41	-50	-64	-20	-25	-11	-16	-25
40	50	-180	-130	-119	-142	-75	-89	-112	-41	-50	-64	-20	-25	-11	-16	-25
		-242	-192	-146	-174	-90	-106	-134	-49	-60	-76	-23	-29	-13	-19	-30
50	65	-190	-140	-100	-100	-60	-60	-60	-30	-30	-30	-10	-10	0	0	0
		-264	-214	-146	-174	-90	-106	-134	-49	-60	-76	-23	-29	-13	-19	-30
65	80	-200	-150	-146	-174	-90	-106	-134	-49	-60	-76	-23	-29	-13	-19	-30
		-274	-224	-170	-207	-107	-126	-159	-58	-71	-90	-27	-34	-15	-22	-35
80	100	-220	-170	-120	-120	-72	-72	-72	-36	-36	-36	-12	-12	0	0	0
		-307	-257	-174	-207	-107	-126	-159	-58	-71	-90	-27	-34	-15	-22	-35
100	120	-240	-180	-174	-207	-107	-126	-159	-58	-71	-90	-27	-34	-15	-22	-35
		-327	-267	-145	-145	-85	-85	-85	-43	-43	-43	-14	-14	0	0	0
120	140	-260	-200	-145	-145	-85	-85	-85	-43	-43	-43	-14	-14	0	0	0
		-360	-300	-208	-245	-125	-148	-185	-68	-83	-106	-32	-39	-18	-25	-40
140	160	-280	-210	-208	-245	-125	-148	-185	-68	-83	-106	-32	-39	-18	-25	-40
		-380	-310	-310	-330	-170	-170	-100	-100	-100	-50	-50	-50	-15	-15	0
160	180	-310	-230	-170	-170	-100	-100	-100	-50	-50	-50	-15	-15	0	0	0
		-410	-330	-242	-285	-146	-172	-215	-79	-96	-122	-35	-44	-20	-29	-46
180	200	-340	-240	-242	-285	-146	-172	-215	-79	-96	-122	-35	-44	-20	-29	-46
		-455	-355	-190	-190	-110	-110	-110	-56	-56	-56	-17	-17	0	0	0
200	225	-380	-260	-190	-190	-110	-110	-110	-56	-56	-56	-17	-17	0	0	0
		-495	-375	-271	-320	-162	-191	-240	-88	-108	-137	-40	-49	-23	-32	-52
225	250	-420	-280	-271	-320	-162	-191	-240	-88	-108	-137	-40	-49	-23	-32	-52
		-535	-395	-210	-210	-125	-125	-125	-62	-62	-62	-18	-18	0	0	0
250	280	-480	-300	-210	-210	-125	-125	-125	-62	-62	-62	-18	-18	0	0	0
		-610	-430	-299	-350	-182	-214	-265	-98	-119	-151	-43	-54	-25	-36	-57
280	315	-680	-400	-299	-350	-182	-214	-265	-98	-119	-151	-43	-54	-25	-36	-57
		-820	-540	-230	-230	-135	-135	-135	-68	-68	-68	-20	-20	0	0	0
315	355	-760	-440	-230	-230	-135	-135	-135	-68	-68	-68	-20	-20	0	0	0
		-915	-595	-327	-385	-198	-232	-290	-108	-131	-165	-47	-60	-27	-40	-63
355	400	-840	-480	-327	-385	-198	-232	-290	-108	-131	-165	-47	-60	-27	-40	-63
		-995	-635													

Hinweis 1) Aufgezeigte Werte im oberen Teil der jeweiligen Linien weisen überdimensionale Toleranzen auf, während die Werte in dem unteren Teil niedrige Toleranzangaben aufweisen.

P

TECHNISCHE DATEN



## Baureihe des geometrischen Toleranzbereichs der Schäfte

h8	h9	js5	js6	js7	k5	k6	m5	m6	n6	p6	r6	s6	t6	u6	x6
0 -14	0 -25	$\pm 2$	$\pm 3$	$\pm 5$	+4 0	+6 0	+6 +2	+8 +2	+10 +4	+12 +6	+16 +10	+20 +14	—	+24 +18	+26 +20
0 -18	0 -30	$\pm 2.5$	$\pm 4$	$\pm 6$	+6 +1	+9 +1	+9 +4	+12 +4	+16 +8	+20 +12	+23 +15	+27 +19	—	+31 +23	+36 +28
0 -22	0 -36	$\pm 3$	$\pm 4.5$	$\pm 7$	+7 +1	+10 +1	+12 +6	+15 +6	+19 +10	+24 +15	+28 +19	+32 +23	—	+37 +28	+43 +34
0 -27	0 -43	$\pm 4$	$\pm 5.5$	$\pm 9$	+9 +1	+12 +1	+15 +7	+18 +7	+23 +12	+29 +18	+34 +23	+39 +28	—	+44 +33	+51 +40 +56 +45
0 -33	0 -52	$\pm 4.5$	$\pm 6.5$	$\pm 10$	+11 +2	+15 +2	+17 +8	+21 +8	+28 +15	+35 +22	+41 +28	+48 +35	—	+54 +41	+67 +54 +77 +64
0 -39	0 -62	$\pm 5.5$	$\pm 8$	$\pm 12$	+13 +2	+18 +2	+20 +9	+25 +9	+33 +17	+42 +26	+50 +34	+59 +43	+64 +48 +70 +54	+76 +60 +86 +70	—
0 -46	0 -74	$\pm 6.5$	$\pm 9.5$	$\pm 15$	+15 +2	+21 +2	+24 +11	+30 +11	+39 +20	+51 +32	+60 +41 +62 +43	+72 +53 +78 +59	+85 +66 +94 +75	+106 +87 +121 +102	—
0 -54	0 -87	$\pm 7.5$	$\pm 11$	$\pm 17$	+18 +3	+25 +3	+28 +13	+35 +13	+45 +23	+59 +37	+73 +51 +76 +54	+93 +71 +101 +79	+113 +91 +126 +104	+146 +124 +166 +144	—
0 -63	0 -100	$\pm 9$	$\pm 12.5$	$\pm 20$	+21 +3	+28 +3	+33 +15	+40 +15	+52 +27	+68 +43	+88 +63 +90 +65 +93 +68	+117 +92 +125 +100 +133 +108	+147 +122 +159 +134 +171 +146	—	—
0 -72	0 -115	$\pm 10$	$\pm 14.5$	$\pm 23$	+24 +4	+33 +4	+37 +17	+46 +17	+60 +31	+79 +50	+106 +77 +109 +80 +113 +84	+151 +122 +159 +130 +169 +140	—	—	—
0 -81	0 -130	$\pm 11.5$	$\pm 16$	$\pm 26$	+27 +4	+36 +4	+43 +20	+52 +20	+66 +34	+88 +56	+126 +94 +130 +98	—	—	—	—
0 -89	0 -140	$\pm 12.5$	$\pm 18$	$\pm 28$	+29 +4	+40 +4	+46 +21	+57 +21	+73 +37	+98 +62	+144 +108 +150 +114	—	—	—	—
0 -97	0 -155	$\pm 13.5$	$\pm 20$	$\pm 31$	+32 +5	+45 +5	+50 +23	+63 +23	+80 +40	+108 +68	+166 +126 +172 +132	—	—	—	—

# INTERNATIONAL EINHEITLICHES SYSTEM

**■ EINHEITLICHE UMRECHNUNGSTABELLE ZUR VEREINFACHUNG DER WANDLUNG IN SI - EINHEITEN (Fettschrift zeigt die SI-Einheiten)**

● **Druck**

Pa	kPa	MPa	bar	kgf/cm <sup>2</sup>	atm	mmH <sub>2</sub> O	mmHg / Torr
1	1×10 <sup>-3</sup>	1×10 <sup>-6</sup>	1×10 <sup>-5</sup>	1.01972×10 <sup>-5</sup>	9.86923×10 <sup>-6</sup>	1.01972×10 <sup>-1</sup>	7.50062×10 <sup>-3</sup>
1×10 <sup>3</sup>	1	1×10 <sup>-3</sup>	1×10 <sup>-2</sup>	1.01972×10 <sup>-2</sup>	9.86923×10 <sup>-3</sup>	1.01972×10 <sup>2</sup>	7.50062
1×10 <sup>6</sup>	1×10 <sup>3</sup>	1	1×10	1.01972×10	9.86923	1.01972×10 <sup>5</sup>	7.50062×10 <sup>3</sup>
1×10 <sup>5</sup>	1×10 <sup>2</sup>	1×10 <sup>-1</sup>	1	1.01972	9.86923×10 <sup>-1</sup>	1.01972×10 <sup>4</sup>	7.50062×10 <sup>2</sup>
9.80665×10 <sup>4</sup>	9.80665×10	9.80665×10 <sup>-2</sup>	9.80665×10 <sup>-1</sup>	1	9.67841×10 <sup>-1</sup>	1×10 <sup>4</sup>	7.35559×10 <sup>2</sup>
1.01325×10 <sup>5</sup>	1.01325×10 <sup>2</sup>	1.01325×10 <sup>-1</sup>	1.01325	1.03323	1	1.03323×10 <sup>4</sup>	7.60000×10 <sup>2</sup>
9.80665	9.80665×10 <sup>-3</sup>	9.80665×10 <sup>-6</sup>	9.80665×10 <sup>-5</sup>	1×10 <sup>-4</sup>	9.67841×10 <sup>-5</sup>	1	7.35559×10 <sup>-2</sup>
1.33322×10 <sup>2</sup>	1.33322×10 <sup>-1</sup>	1.33322×10 <sup>-4</sup>	1.33322×10 <sup>-3</sup>	1.35951×10 <sup>-3</sup>	1.31579×10 <sup>-3</sup>	1.35951×10	1

Hinweis: 1Pa=1N/m<sup>2</sup>

● **Kraft**

N	dyn	kgf
1	1×10 <sup>5</sup>	1.01972×10 <sup>-1</sup>
1×10 <sup>-5</sup>	1	1.01972×10 <sup>-6</sup>
9.80665	9.80665×10 <sup>5</sup>	1

● **Beanspruchung**

Pa	MPa oder N/mm <sup>2</sup>	kgf/mm <sup>2</sup>	kgf/cm <sup>2</sup>
1	1×10 <sup>-6</sup>	1.01972×10 <sup>-7</sup>	1.01972×10 <sup>-5</sup>
1×10 <sup>6</sup>	1	1.01972×10 <sup>-1</sup>	1.01972×10
9.80665×10 <sup>6</sup>	9.80665	1	1×10 <sup>2</sup>
9.80665×10 <sup>4</sup>	9.80665×10 <sup>-2</sup>	1×10 <sup>-2</sup>	1

Hinweis: 1Pa=1N/m<sup>2</sup>

● **Arbeit / Energie / Hitzeleistung**

J	kW·h	kgf·m	kcal
1	2.77778×10 <sup>-7</sup>	1.01972×10 <sup>-1</sup>	2.38889×10 <sup>-4</sup>
3.600 ×10 <sup>6</sup>	1	3.67098×10 <sup>5</sup>	8.6000 ×10 <sup>2</sup>
9.80665	2.72407×10 <sup>-6</sup>	1	2.34270×10 <sup>-3</sup>
4.18605×10 <sup>3</sup>	1.16279×10 <sup>-3</sup>	4.26858×10 <sup>2</sup>	1

Hinweis: 1J=1W·s, 1J=1N·m  
1cal=4.18605J  
(Nach geltendem Recht über Gewichte und Maße)

● **Produktionsanteil / Antriebskraft / Hitzedurchflussverhältnis**

W	kgf·m/s	PS	kcal/h
1	1.01972×10 <sup>-1</sup>	1.35962×10 <sup>-3</sup>	8.6000 ×10 <sup>-1</sup>
9.80665	1	1.33333×10 <sup>-2</sup>	8.43371
7.355 ×10 <sup>2</sup>	7.5 ×10	1	6.32529×10 <sup>2</sup>
1.16279	1.18572×10 <sup>-1</sup>	1.58095×10 <sup>-3</sup>	1

Hinweis: 1W=1J/s, PS:Pferdestärke  
1PS=0.7355kW  
1cal=4.18605J  
(Nach geltendem Recht über Gewichte und Maße)

# VERSCHLEISSARTEN

## URSACHE UND GEGENMASSNAHME

Verschleißart	Ursache	Gegenmaßnahme
<b>Freiwinkelverschleiß</b> 	<ul style="list-style-type: none"> <li>• Hartmetallsorte ist zu weich.</li> <li>• Schnittgeschwindigkeit ist zu hoch.</li> <li>• Anstellwinkel ist zu klein.</li> <li>• Vorschub ist extrem gering.</li> </ul>	<ul style="list-style-type: none"> <li>• Hartmetallsorte mit hoher Verschleißfestigkeit.</li> <li>• Schnittgeschwindigkeit verringern.</li> <li>• Anstellwinkel vergrößern.</li> <li>• Vorschub erhöhen.</li> </ul>
<b>Kolkverschleiß</b> 	<ul style="list-style-type: none"> <li>• Hartmetallsorte ist zu weich.</li> <li>• Schnittgeschwindigkeit ist zu hoch.</li> <li>• Vorschub ist zu hoch.</li> </ul>	<ul style="list-style-type: none"> <li>• Hartmetallsorte mit hoher Verschleißfestigkeit.</li> <li>• Schnittgeschwindigkeit verringern.</li> <li>• Vorschub verringern.</li> </ul>
<b>Ausbröckeln</b> 	<ul style="list-style-type: none"> <li>• Hartmetallsorte ist zu hart.</li> <li>• Vorschub ist zu hoch.</li> <li>• Zu geringe Schneidkantenstärke.</li> <li>• Zu geringe Werkzeugstabilität.</li> </ul>	<ul style="list-style-type: none"> <li>• Hartmetallsorte mit hoher Zähigkeit.</li> <li>• Vorschub verringern.</li> <li>• Größere Verfasung. (Verrundungen müssen verfast werden.)</li> <li>• Einsatz von größeren Schaftquerschnitt.</li> </ul>
<b>Bruch</b> 	<ul style="list-style-type: none"> <li>• Hartmetallsorte ist zu hart.</li> <li>• Vorschub ist zu hoch.</li> <li>• Zu geringe Schneidkantenstärke.</li> <li>• Zu geringe Werkzeugstabilität.</li> </ul>	<ul style="list-style-type: none"> <li>• Hartmetallsorte mit hoher Zähigkeit.</li> <li>• Vorschub verringern.</li> <li>• Größere Verfasung. (Verrundungen müssen verfast werden.)</li> <li>• Einsatz von größeren Schaftquerschnitt.</li> </ul>
<b>Plastische Deformation</b> 	<ul style="list-style-type: none"> <li>• Hartmetallsorte ist zu weich.</li> <li>• Schnittgeschwindigkeit ist zu hoch.</li> <li>• Schnitttiefe und Vorschub ist zu groß.</li> <li>• Schnitttemperatur ist zu hoch.</li> </ul>	<ul style="list-style-type: none"> <li>• Hartmetallsorte mit hoher Verschleißfestigkeit.</li> <li>• Schnittgeschwindigkeit verringern.</li> <li>• Schnitttiefe und Vorschub verringern.</li> <li>• Hartmetallsorte mit hoher Wärmebeständigkeit.</li> </ul>
<b>Aufbauschneide</b> 	<ul style="list-style-type: none"> <li>• Schnittgeschwindigkeit ist zu gering.</li> <li>• Geringe Schärfe.</li> <li>• Falsche Sorte.</li> </ul>	<ul style="list-style-type: none"> <li>• Schnittgeschwindigkeit erhöhen. (Für DIN Ck45, Schnittgeschwindigkeit 80m/min.)</li> <li>• Spanwinkel vergrößern.</li> <li>• Hartmetall mit geringer Affinität. (Hartmetall beschichtet, CERMET)</li> </ul>
<b>Thermischer Verschleiß</b> 	<ul style="list-style-type: none"> <li>• Wechselnde Temperaturbedingungen an der Schneidkante.</li> <li>• Hartmetallsorte ist zu weich.</li> <li>• *Hauptsächlich Fräsen.</li> </ul>	<ul style="list-style-type: none"> <li>• Trockenbearbeitung. (Bei Nassbearbeitung gleichmäßige Kühlung aller Schneidkanten)</li> <li>• Hartmetallsorte mit hoher Zähigkeit.</li> </ul>
<b>Kerbverschleiß</b> 	<ul style="list-style-type: none"> <li>• Harte oder rohe Oberfläche verursachen Kerbbildung auf der Schneidkantenoberfläche.</li> <li>• Reibung verursacht Kerben bei der Spanbildung. (Ursache: leichte Vibrationen)</li> </ul>	<ul style="list-style-type: none"> <li>• Hartmetallsorte mit hoher Verschleißfestigkeit.</li> <li>• Spanwinkel vergrößern, um Schärfe zu verbessern.</li> </ul>
<b>Abplatzen von Beschichtung und Hartmetall</b> 	<ul style="list-style-type: none"> <li>• Schneidkante verklebt und bricht aus.</li> <li>• Schlechte Spanabfuhr.</li> </ul>	<ul style="list-style-type: none"> <li>• Spanwinkel vergrößern, um Schärfe zu verbessern.</li> <li>• Spankammer vergrößern.</li> </ul>
<b>Freiflächenverschleiß Bruch</b>  <p>*Beschädigung bei PKD und PCBN</p>	<ul style="list-style-type: none"> <li>• Verschleiß aufgrund fehlender Schneidkantenstabilität. (Gebogene Schneidkantenführung)</li> </ul>	<ul style="list-style-type: none"> <li>• Größere Verfasung.</li> <li>• Hartmetallsorte mit hoher Zähigkeit.</li> </ul>
<b>Kolkverschleiß Bruch</b>  <p>*Beschädigung bei PKD und PCBN</p>	<ul style="list-style-type: none"> <li>• Hartmetallsorte ist zu weich.</li> <li>• Hohe Schnittkraft verursacht hohe Temperaturen an der Schneidkante.</li> </ul>	<ul style="list-style-type: none"> <li>• Kleinere Verfasung.</li> <li>• Hartmetallsorte mit hoher Verschleißfestigkeit.</li> </ul>

TECHNISCHE DATEN

# SCHNEIDSTOFFSORTEN

Hartmetall WC-Co wurde 1923 entwickelt und später durch Zugabe von TiC und TaC verbessert. Im Jahre 1969 wurde die CVD Beschichtungstechnologie entwickelt und besch. Hartmetall fand eine weite Anwendung. Auf TiC-TiN basierendes Cermet wurde 1974 entwickelt. Heute ist die Kombination "Beschichtetes Hartmetall zur Vorbearbeitung und Cermet für die Fertigbearbeitung" ein sehr gut etablierter Trend.

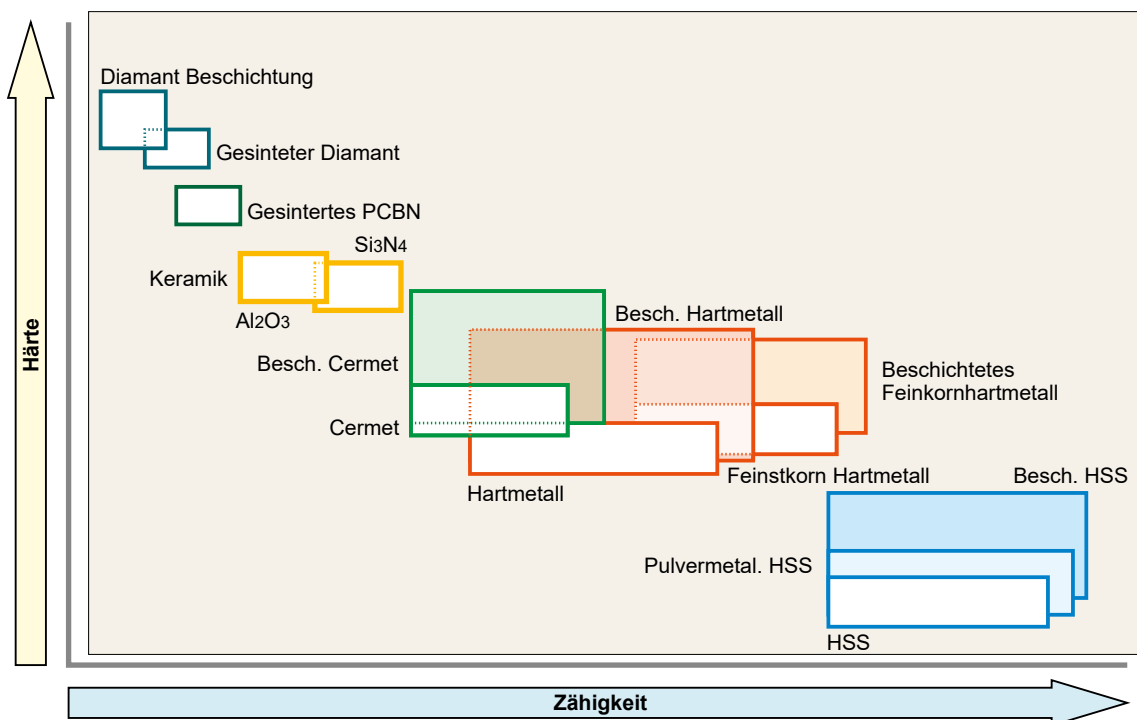

P

## SORTENEIGENSCHAFTEN

Hartstoffe	Härte (HV)	Freie Energie (kcal/g·atom)	Löslichkeit in Eisen (%.1250°C)	Therm. Leitfähigkeit (W/m·k)	Therm. * Ausdehnung (x 10 <sup>-6</sup> /k)	Schneidstoff
Diamant	>9000	–	Hoch löslich	2100	3.1	Gesinteter Diamant
PCBN	>4500	–	–	1300	4.7	Gesintertes PCBN
Si <sub>3</sub> N <sub>4</sub>	1600	–	–	100	3.4	Keramik
Al <sub>2</sub> O <sub>3</sub>	2100	-100	≐0	29	7.8	Keramik Hartmetall
TiC	3200	-35	< 0.5	21	7.4	Cermet Besch. Hartmetall
TiN	2500	-50	–	29	9.4	Cermet Besch. Hartmetall
TaC	1800	-40	0.5	21	6.3	Hartmetall
WC	2100	-10	7	121	5.2	Hartmetall

\*1W/m·K=2.39×10<sup>-3</sup>cal/cm·sec·°C

TECHNISCHE DATEN

# SORTEN-ÜBERSICHT

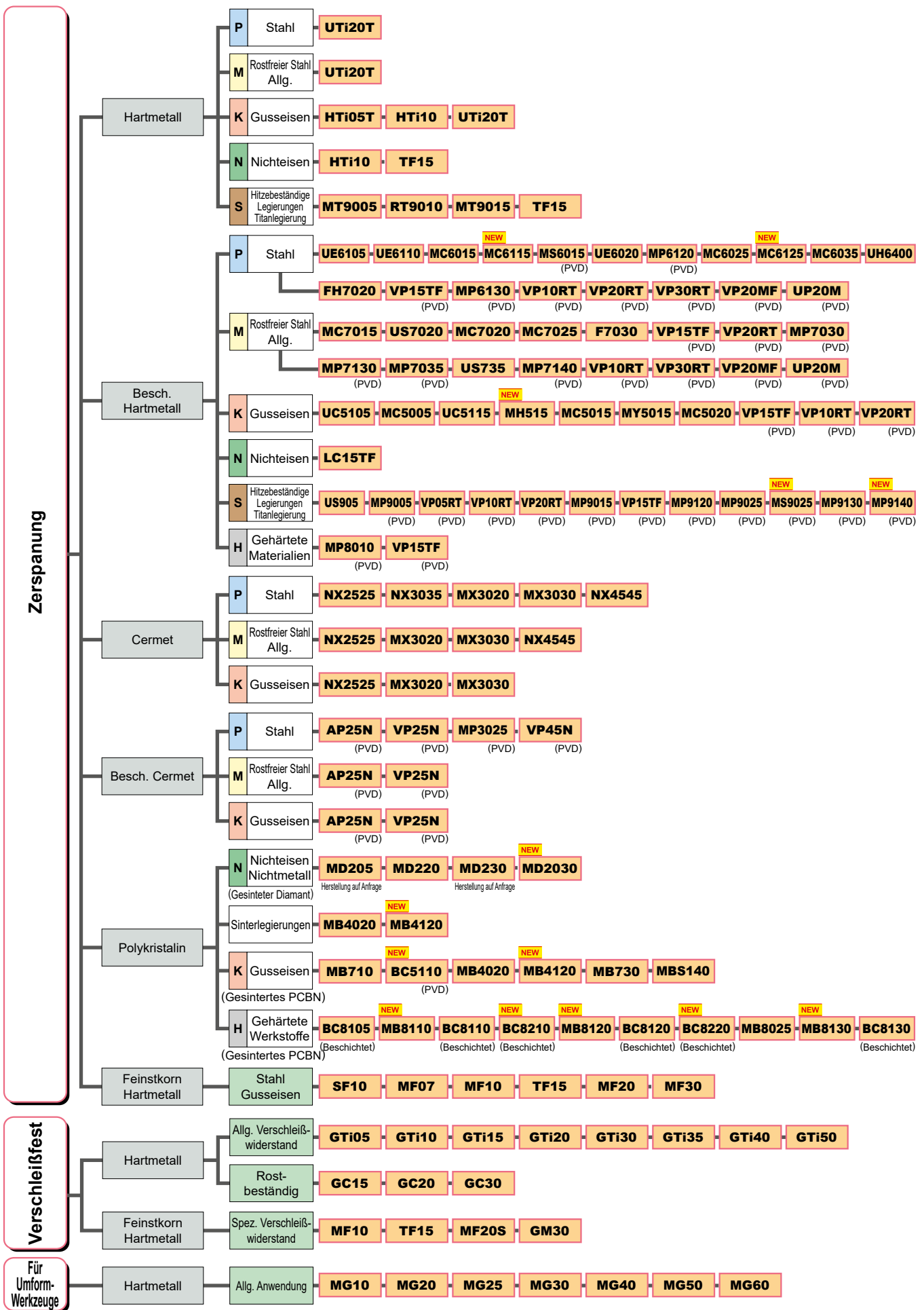

TECHNISCHE DATEN

# SORTEN-VERGLEICHSTABELLE

## HARTMETALL

	ISO		Mitsubishi Materials	Sandvik	Kennametal	Seco Tools	Iscar	Sumitomo Electric	Tungaloy	Kyocera	Dijet	MOLDINO	
	Klasse	Abkürzung											
Drehen	P	P01											
		P10					IC70	ST10P	TH10			WS10	
		P20	UTi20T					IC70 IC50M	ST20E	KS20			EX35
		P30	UTi20T					IC50M IC54	A30 A30N	UX30 KS15F			EX35
		P40						IC54	ST40E	TX40			EX35
	M	M10				KU10 K313 K68	890	IC07	EH510	TH10			WA10B
		M20	UTi20T			KU10 K313 K68	HX 883	IC07 IC08 IC20	EH520	KS20			EX35
		M30	UTi20T					IC08 IC20 IC28	A30 A30N	UX30			EX35
		M40						IC28		TU40			
	K	K01	HTi05T			KU10 K313 K68			H1 H2	KS05F			WH01 WH05
		K10	HTi10			KU10 K313 K68	890	IC20	EH510	TH10	KW10 GW15	KT9	WH10
		K20	UTi20T	H13A		KU10 K313 K68	HX	IC20	G10E H10E EH520	KS15F KS20	GW25	KT9	WH20
		K30	UTi20T				883		G10E H10E				
	N	N01		H10					H1 H2	KS05F	GW05 KW10		
		N10	HTi10	H10 HBA		KU10 K313 K68	890	IC08 IC20	EH510	TH10	KW10 GW15	KT9	WH10
		N20		H10 HBA		KU10 K313 K68	HX KX	IC08 IC20	G10E EH520	KS15F		KT9	WH20
		N30					883						
	S	S01	MT9005								SW05		
		S10	MT9005 RT9010 MT9015	H10A H10F H13A		KU10 K313 K68	HX 883	IC07 IC08	EH510	KS05F TH10	SW10		WH13S
		S20	RT9010 TF15			KU10 K313 K68	883	IC07 IC08	EH520	KS15F KS20	SW25		
S30		TF15											
Fräsen	P	P10											
		P20	UTi20T			K125M		IC50M IC28	A30N			EX35	
		P30	UTi20T	SM30	GX			IC50M IC28	A30N	UX30			EX35
		P40						IC28					EX35
	M	M10											
		M20	UTi20T						IC08 IC20	A30N			EX35
		M30	UTi20T	SM30					IC08 IC28	A30N			EX35
		M40							IC28				
	K	K01	HTi05T			K115M,K313							
		K10	HTi10			K115M K313			IC20	G10E	TH10	KW10 GW25	KT9 WH10
		K20	UTi20T	H13A			HX	IC20	G10E		GW25	FZ15	WH20
		K30	UTi20T										

Hinweis 1) Die Schneidstoffsorten anderer Hersteller wurden der Fachliteratur entnommen und können von Herstellerangaben abweichen.

P

TECHNISCHE DATEN

## FEINSTKORN HARTMETALLE

	ISO		Mitsubishi Materials	Sandvik	Kennametal	Seco Tools	Sumitomo Electric	Tungaloy	Kyocera	Dijet	MOLDINO
	Klasse	Abkürzung									
Werkzeugherstellung	Z	Z01	SF10 MF07 MF10	PN90 6UF,H3F 8UF,H6F			F0	F MD05F MD1508		FZ05 FB05 FB10	NM08
		Z10	HTi10 MF20	H10F		890	XF1 F1 AFU	MD10 MD0508 MD07F	FW30	FZ10 FZ15 FB15	NM10 NM12 NM15
		Z20	TF15 MF30	H15F		890 883	AF0 SF2 AF1	EM10 MD20 G1F		FZ15 FB15 FB20	BRM20 EF20N
		Z30				883	A1 CC			FZ20 FB20	NM25 NM40

## CERMET

	ISO		Mitsubishi Materials	Sandvik	Kennametal	Seco Tools	Iscar	Sumitomo Electric	Tungaloy	Kyocera	Dijet	MOLDINO	
	Klasse	Abkürzung											
Drehen	P	P01	AP25N* VP25N*				IC20N IC520N*	T1000A	NS520 GT720*	CCX* TN610 PV710* PV30*			
		P10	NX2525 AP25N* VP25N*	CT5015 GC1525*	KT315 KT125	TP1020 TP1030* CM CMP*	IC20N IC520N* IC530N*	T1500A T1500Z*	NS520 NS9530 GT9530* AT9530*	CCX* TN60 TN610 PV710* TN620 PV720*	CX75	CZ25*	
		P20	NX2525 AP25N* VP25N* NX3035 MP3025*	GC1525*	KT325 KT1120 KT5020*	TP1020 TP1030*	IC20N IC520N* IC30N IC530N* IC75T	T1500A T1500Z* T2500A T2500Z* T3000Z*	NS9530 GT9530* AT9530*	TN60 TN620 PV720* TN6020	CX75 PX90*	CH550	
		P30	MP3025* VP45N*				IC75T	T3000Z*		PV730* PV90*	PX90*		
	M	M10	NX2525 AP25N* VP25N*	GC1525*	KT125	TP1020 TP1030* CM CMP*		T1000A T1500Z*		TN60 TN620 PV720* TN6020			CZ25*
		M20	NX2525 AP25N* VP25N*					T1500A T1500Z*		TN90 TN6020 TN620 PV720* PV90*			CH550
		M30								PV730*			
	K	K01	NX2525 AP25N*					T1000A	NS520 GT720*	CCX* PV7005*			
		K10	NX2525 AP25N*	CT5015	KT325 KT125				NS520 NS9530 GT9530*	CCX* PV7005* TN60			CZ25*
		K20	NX2525 AP25N*										CH550
Fräsen	P	P10	NX2525			C15M	IC30N			TN620M TN60	CX75	MZ1000*	
		P20	MX3020 NX2525	CT530	KT530M HT7 KT605M	C15M MP1020	IC30N	T250A T2500A		TN100M TN620M TN60	CX75 CX90	CH550 CH7030 MZ1000*	
		P30	MX3030 NX4545				IC30N	T4500A	NS740		CX90	CH7035	
	M	M10	NX2525					IC30N			TN60		
		M20	MX3020 NX2525	CT530	KT530M HT7 KT605M	C15M	IC30N	T250A T2500A			TN100M	CX75	
		M30	MX3030 NX4545					T4500A					
	K	K01											
		K10	NX2525								TN60	CX75	
		K20	NX2525		KT530M HT7							CX75	

\*Besch. Cermet

Hinweis 1) Die Schneidstoffsorten anderer Hersteller wurden der Fachliteratur entnommen und können von Herstellerangaben abweichen.

P

TECHNISCHE DATEN



# SORTEN-VERGLEICHSTABELLE

## CVD-BESCHICHTETE SORTEN

	ISO		Mitsubishi Materials	Sandvik	Kennametal	Seco Tools	Iscar	Sumitomo Electric	Tungaloy	Kyocera	Dijet	MOLDINO		
	Klasse	Abkürzung												
<b>Drehen</b>	<b>P</b>	<b>P01</b>	MC6115 UE6105	GC4305 GC4205 GC4415	KCP05B KCP05 KC9105	TP0501 TP0500 TP1501 TP1500	IC9150 IC8150 IC428	AC810P AC700G	T9105 T9025	CA510 CA5505	JC110V	HG8010		
		<b>P10</b>	MC6115 UE6105 MC6015 UE6110 MY5015	GC4315 GC4215 GC4325 GC4415	KCP10B KCP10 KCP25 KC9110	TP1501 TP1500 TP2501 TP2500	IC9150 IC8150 IC8250	AC810P AC700G AC820P AC2000 AC8015P	T9105 T9115 T9215	CA510 CA5505 CA515 CA5515	JC110V JC215V	HG8010 HG8025 GM8020		
		<b>P20</b>	MC6115 MC6015 UE6110 MC6125 MC6025 UE6020 MY5015	GC4315 GC4215 GC4325 GC4425	KCP25B KCP30B KCP25 KC9125	TP2501 TP2500	IC8250 IC9250 IC8350	AC820P AC2000 AC8025P AC830P	T9115 T9125 T9215 T9225	CA025P CA515 CA5515 CA525 CA5525 CR9025	JC110V JC215V	HG8025 GM8020 GM25		
		<b>P30</b>	MC6125 MC6025 UE6020 MC6035 UH6400	GC4325 GC4335 GC4225 GC4235 GC4425	KCP30B KCP30	TP3501 TP3500 TP3000	IC8350 IC9250 IC9350	AC8035P AC830P AC630M	T9125 T9135 T9225 T9235	CA025P CA525 CA5525 CA530 CA5535 CR9025	JC215V JC325V	GM25 GM8035		
		<b>P40</b>	MC6035 UH6400	GC4235 GC4335	KCP40 KCP40B KC9140 KC9240	TP3501 TP3500 TP3000	IC9350	AC8035P AC630M	T9135 T9035 T9235	CA530 CA5535	JC325V	GM8035 GX30		
	<b>M</b>	<b>M10</b>	MC7015 US7020	GC2015 GC2220	KCM15B KCM15	TM1501 TM2000	IC6015 IC8250	AC610M AC6020M	T6120 T9215	CA6515	JX605X JC110V			
		<b>M20</b>	MC7015 US7020 MC7025	GC2015 GC2220	KCM15 KCM25B KCP40B	TM2000 TM2501	IC6015	AC6020M AC610M AC6030M AC630M	T6120 T9215	CA6515 CA6525	JC110V	HG8025 GM25		
		<b>M30</b>	MC7025 US735	GC2025	KCM25 KCM35B KCP40	TM4000 TM3501	IC6025	AC6030M AC630M	T6130	CA6525	JX525X	GM8035 GX30		
		<b>M40</b>	US735	GC2025	KCM35B KCM35	TM4000 TM3501	IC6025	AC6030M AC630M			JX525X	GX30		
	<b>K</b>	<b>K01</b>	MC5005 UC5105	GC3205 GC3210	KCK05B KCK05	TK0501 TH1500	IC5005	AC405K AC410K AC4010K	T505 T515 T5105	CA4505 CA4010 CA310	JC050W JC105V	HX3505		
		<b>K10</b>	MC5015 MH515 UC5115 MY5015	GC3205 GC3210	KCK15B KCK15 KCK20 KC9315 KCK20B	TK0501 TK1501	IC5005 IC5010 IC428	AC405K AC4010K AC410K AC4015K AC415K	T515 T5115	CA315 CA4515 CA4010 CA4115	JC108W JC050W JC105V JC110V	HX3515 HG8010		
		<b>K20</b>	MC5015 MH515 UC5115 UE6110 MY5015	GC3225	KCK20B KCK20 KCPK05	TK1501	IC5010 IC8150	AC4015K AC415K AC420K AC8025P	T5115 T5125	CA320 CA4515 CA4115 CA4120	JC108W JC110V JC215V	HG8025 GM8020		
		<b>K30</b>	UE6110	GC3225	KCPK05			AC8025P	T5125		JC215	HG8025 GM8020		
	<b>Fräsen</b>	<b>P</b>	<b>P10</b>				MP1501	IC5400	ACP2000 XCU2500 ACP100			JC730U		
			<b>P20</b>	F7030 MC7020	GC4220		MP1501 MP2501 T25M	IC5500	ACP2000 ACP3000 XCU2500 ACP100	T3130 T3225		JC730U JC835S	GX2140 GF30	
			<b>P30</b>	F7030 MC7020	GC4330 GC4230	KCPK30 KC930M	MP1501 MP2501 TM25 T350	IC5500	ACP3000 XCU2500 ACP100	T3130 T3225		JC835S JC730U	GX2140 GX2160 GF30	
			<b>P40</b>		GC4340 GC4240	KC935M KC530M	MM4500 T350M						GX2030 GX2160	
		<b>M</b>	<b>M10</b>							XCU2500			JC730U	
			<b>M20</b>	US735 MC7020		KC925M	MP2501 MS2500 T25M T350M		ACP100 ACM200 XCU2500	T3130 T3225	CA6535	JC730U JC835S	AX2040 GX2140	
			<b>M30</b>	US735 FC7020 MC7020	GC2040	KC930M	MP2501 T25M T350M		ACP100 XCU2500 ACM200	T3130 T3225	CA6535	JC730U JC835S	AX2040 GX2140 GX2160 GX30	
<b>M40</b>					KC930M KC935M	MM4500 T350M						GX2160		
<b>K</b>		<b>K01</b>												
		<b>K10</b>	MC5020					XCK2000 ACK200	T1215 T1115	CA420M	JC605W	GX2120		
		<b>K20</b>	MC5020	GC3220 GC3330 K20W	KC915M	MP1501	IC5100	ACK200 XCK2500 XCK2000 ACK200	T1115		JC610 JC605W JC608X	GX2120		
		<b>K30</b>		GC3330 GC3040	KC920M KC925M KCPK30 KC930M KC935M	MP1501	IC5100 DT7150				JC610			

TECHNISCHE DATEN

P

Hinweis 1) Die Schneidstoffsorten anderer Hersteller wurden der Fachliteratur entnommen und können von Herstellerangaben abweichen.

# PVD-BESCHICHTETE SORTEN

	ISO		Mitsubishi Materials	Sandvik	Kennametal	Seco Tools	Iscar	Sumitomo Electric	Tungaloy	Kyocera	Dijet	MOLDINO	
	Klasse	Abkürzung											
Drehen	P	P01								PR1005			
		P10	VP10MF MS6015	GC1125	KCU10 KC5010 KC5510 KU10T	CP200 TS2000	IC250 IC507 IC570 IC807 IC907 IC908		AH710 SH725	PR1005 PR1705 PR930 PR1025 PR1115 PR1225 PR1425 PR1725			
		P20	VP10RT VP20RT VP15TF VP20MF MS6015	GC1125 GC15	KCU10 KC5025 KC5525 KU25T	TS2500	IC1007 IC250 IC308 IC507 IC807 IC808 IC907 IC908 IC1008 IC1028 IC3028	AC520U	AH710 AH725 AH120 SH730 GH730 GH130 SH725	PR930 PR1025 PR1725 PR1115 PR1225 PR1425 PR1535		IP2000	
		P30	VP10RT VP20RT VP15TF VP20MF	GC1125	KCU25 KC5525 KU25T	CP500	IC228 IC250 IC328 IC330 IC354 IC528 IC1008 IC1028 IC3028	AC1030U AC530U	AH725 AH120 SH730 GH730 GH130 AH740 J740 SH725 AH7025	PR1025 PR1725 PR1225 PR1425 PR1535 PR1625		IP3000	
		P40				CP500 CP600	IC228 IC328 IC528 IC928 IC1008 IC1028 IC3028		AH740 J740	PR1535			
	M	M01											
		M10	VP10MF MS6015	GC1115 GC15 GC1105	KCU10 KC5010 KC5510	CP200 TS2000	IC354 IC507 IC520 IC807 IC907 IC1007 IC5080T		AC8005 AH710 SH725	PR1025 PR1225 PR1425 PR1725	JC5003 JC8015	IP050S	
		M20	VP10RT VP20RT VP15TF VP20MF MS9025	GC1115 GC15 GC1125	KCU10 KC5010 KC5510	TS2500 CP500	IC354 IC808 IC908 IC1008 IC1028 IC3028 IC5080T	AC520U AC5015S	AH710 AH725 AH120 SH730 GH730 GH130 GH330 AH630 SH725 AH8015 AH7025	PR1025 PR1125 PR1225 PR1425 PR915 PR930 PR1535 PR1725	JC5003 JC5015 JC8015 JC5118	IP100S	
		M30	VP10RT VP20RT VP15TF VP20MF MP7035	GC1125 GC2035	KCU25 KC5525	CP500 CP600 TTP2050	IC228 IC250 IC328 IC330 IC1008 IC1028 IC9080T	AC520U AC530U AC1030U AC6040M AC5025S	GH330 AH725 AH120 SH730 GH730 GH130 J740 AH645 SH725	PR1125 PR1725 PR1425 PR1535	JC5015 JC8015 JC5118		
		M40	MP7035	GC2035			IC328 IC928 IC1008 IC1028 IC3028 IC9080T	AC530U AC6040M	J740	PR1535	JC5118		
	K	K01											
		K10		GC15	KCU10 KC5010 KC5510	CP200 TS2000	IC350 IC910 IC1008	AC510U	GH110 AH110 AH710				
		K20	VP10RT VP20RT VP15TF		KCU15 KCU25	CP200 TS2000 TS2500	IC228 IC350 IC808 IC830 IC908 IC1007 IC1008		GH110 AH7025 AH110 AH710 AH725 AH120 GH730 GH130				
		K30	VP10RT VP20RT VP15TF		KCU25 KC5525	CP500	IC228 IC350 IC808 IC830 IC908 IC928 IC1007 IC1008		AH725 AH120 GH730 GH130				
	S	S01	MP9005 VP05RT			TH1000	IC507 IC804 IC807 IC907 IC5080T	AC5005S	AH905 AH8005	PR005S PR1305	JC5003 JC8015	JP9105	
		S10	MP9005 MP9015 VP10RT	GC1105 GC15	KCU10 KC5010 KC5410 KC5510	CP200 CP250 TS2000 TS2050 TS2500 TH1000	IC507 IC806 IC807 IC903 IC5080T	AC510U AC5015S	AH905 SH730 AH110 AH8005 AH120	PR005S PR015S PR1310	JC5003 JC5015 JC8015	JP9115	
		S20	MP9015 MT9015	GC1125	KCU10 KCU25 KC5025 KC5525	TS2500 CP500	IC228 IC300 IC328 IC808 IC908 IC928 IC3028 IC806 IC9080T	AC510U AC520U AC5025S	AH120 AH725 AH8015	PR015S PR1125 PR1325	JC5015 JC8015 JC5118		
		S30	MS9025 MP9025 VP15TF VP20RT	GC1125	KC5525	CP600	IC928 IC830	AC1030U	AH725 AH7025	PR1125 PR1535	JC5118		
	Fräsen	P	P01					IC903				JC8003	ATH80D ATH08M TH308 PN208 JP4105 PN15M
			P10		GC1010 GC1130	KC505M KC715M KC510M KC515M		IC250 IC350 IC808 IC810 IC900 IC903 IC908 IC910 IC950	ACU2500 ACP200	PR830 PR1225	JC8003 JC8015 JC5015 JC5118	PN15M PN215 PCA12M JP4115	
P20			MP6120 VP15TF	GC1010 GC1030 GC1130 GC2030	KC522M KC525M KC527M KC610M KC620M KC635M KC715M KC720M KC730M KTPK20	F25M MP3000	IC250 IC300 IC328 IC330 IC350 IC808 IC810 IC830 IC900 IC908 IC910 IC928 IC950 IC1008	ACU2500 ACP200	AH3225 AH725 AH120 GH330 AH330 AH9130 AH6030	PR830 PR1225 PR1230 PR1525	JC5015 JC5040 JC6235 JC8015 JC5118 JC6235 JC7560P JC8118P	CY9020 JP4120 CY150	

Hinweis 1) Die Schneidstoffsorten anderer Hersteller wurden der Fachliteratur entnommen und können von Herstellerangaben abweichen.

P

TECHNISCHE DATEN

# SORTEN-VERGLEICHSTABELLE

## PVD-BESCHICHTETE SORTEN

	ISO		Mitsubishi Materials	Sandvik	Kennametal	Seco Tools	Iscar	Sumitomo Electric	Tungaloy	Kyocera	Dijet	MOLDINO	
	Klasse	Abkürzung											
Fräsen	P	P30	MP6120 VP15TF MP6130 VP30RT	GC1010 GC1030 GC2030 GC1130	KC735M KC725M KC530M KC537M KCPM40	F25M MP3000 F30M MP2050	IC250 IC300 IC328 IC330 IC350 IC830 IC845 IC900 IC928 IC950 IC1008	ACU2500 ACP200 ACP300	AH725 AH120 AH130 AH140 GH130 AH730 AH3035 AH6030 AH3225 AH9130	PR1230 PR1525	JC6235 JC7560 JC8050 JC7560P JC5015 JC8118 JC5040 JC8118P JC8015 JC5118	JS4045 CY250 CY250V CY25 HC844	
			P40	VP30RT	GC2030 GC1030 GC1130	KC735M KC537M KCPM40	F40M T60M	IC300 IC328 IC330 IC830 IC928 IC1008	ACP300	AH140 AH3035	PR1525	JC6235 JC7560 JC8050 JC7560P JC5040 JC8118 JC5118 JC8118P JC5118	JS4060 PTH30E PTH40H JX1060 JS4060
	M	M01						IC907					PN08M PN208
		M10		GC1025 GC1030 GC1010 GC1130	KC715M KC515M			IC903	ACU2500 ACM100		PR1225		PN15M PN215
		M20	VP15TF MP7130 MP7030 VP20RT	GC1025 GC1030 GC1040 GC2030 S30T	KC610M KC635M KC730M KC720M KC522M KC525M KCPM40 KTPK20	F25M MP3000	IC250 IC300 IC808 IC830 IC900 IC908 IC928 IC1008	ACU2500 ACP200	AH725 AH120 GH330 AH330 GH110 AH6030 AH9130	PR1025 PR1225	JC5015 JC5118 JC8015	JP4120	
		M30	VP15TF MP7130 MP7030 VP20RT MP7140 VP30RT	S30T GC1040 GC2030	KC537M KC725M KC735M KCPM40 KC530M	F30M F40M MP3000 MP2050	IC250 IC300 IC328 IC330 IC380 IC830 IC882 IC928 IC1008	ACP200 ACP300 ACM300	AH120 AH725 AH130 AH140 GH130 AH730 GH340 AH9130 AH3135 AH4035	PR830 PR1225 PR1525 PR1535	JC5015 JC7560 JC8015 JC7560P JC8050 JC8118 JC5118 JC8118P	JS4045 CY250 HC844	
		M40	MP7140 VP30RT			F40M MP2050	IC250 IC300 IC328 IC330 IC882 IC1008	ACP300 ACM300	AH140 AH3135 AH4035	PR1525 PR1535	JC5015 JC7560 JC5118 JC7560P JC8050 JC8118 JC8118P	PTH30E PTH40H JM4160	
	K	K01	MP8010							AH110 GH110 AH330		JC8003	ATH80D ATH08M TH308
		K10	MP8010	GC1010	KC514M KC515M KC527M KC635M	MK2050	IC350 IC810 IC830 IC900 IC910 IC928 IC950 IC380 IC1008	ACU2500 ACK3000	AH110 GH110 AH725 AH120 GH130 AH330	PR1210 PR1510	JC8015	ATH10E TH315 CY100H	
		K20	VP15TF VP20RT	GC1010 GC1020	KTPK20 KC514M KC610M KC520M KC620M KC524M	MK2000 MK2050	IC350 IC808 IC810 IC830 IC900 IC908 IC910 IC928 IC950 IC1008	ACU2500 ACK300 ACK3000	GH130 AH9130 AH9030	PR1210 PR1510	JC5015 JC8015 JC6235	CY150 JP4120 CY9020 PTH13S	
		K30	VP15TF VP20RT	GC1020	KC522M KC725M KC524M KC735M KC537M	MK2050	IC350 IC808 IC830 IC908 IC928 IC950 IC1008	ACK300 ACK3000				JC6235 JC5015 JC8015 JC8118 JC8118P	CY250 JS4045
	S	S01						IC907 IC908 IC808 IC903		AH110 AH710	PR1210	JC8003 JC8015 JC5118	PN08M PN208
		S10	MP9120 VP15TF	GC1130 GC1010 GC1030 GC2030	KC510M	MS2050	IC903 IC907 IC908 IC840 IC910 IC808	EH520Z EH20Z ACM100	AH120 AH725	PR1210	JC8003 JC5015 JC8015 JC5118	JS1025 JP4120	
		S20	MP9120 VP15TF MP9130 MP9030	S30T GC2030 GC1030 GC1130	KC522M KC525M KCSM30 KCPM40	MS2050 MP2050	IC300 IC908 IC808 IC900 IC830 IC928 IC328 IC330 IC840 IC882 IC380	EH520Z EH20Z ACK300 ACP300	AH725 AH6030 AH130	PR1535	JC8015 JC5015 JC8050 JC5118	PTH30H	
		S30		GC2030 GC1040	KC725M KCPM40	MS2050 F40M KCSM40	IC830 IC882 IC928	ACP300 ACM300	AH3135	PR1535	JC8050 JC7560 JC5118	JM4160	
	H	H01	MP8010 VP05HT					IC903				JC8003 DH103 JC8008 DH102	
		H10	VP15TF VP10H	GC1130 GC1010 GC1030	KC505M KC510M	MH1000 F15M	IC900 IC808 IC907 IC905					JC8003 JC8008 JC8015 JC5118 JC8118P	JP4105 TH303 TH308 PTH08M ATH08M ATH80D
		H20	VP15TF	GC1030 GC1130			F15M	IC900 IC808 IC908 IC380 IC1008		AH3135		JC8015 JC5118 JC8118P	JP4115 TH315
		H30					MP3000 F30M	IC380 IC900 IC1008		AH3135			JP4120

Hinweis 1) Die Schneidstoffsorten anderer Hersteller wurden der Fachliteratur entnommen und können von Herstellerangaben abweichen.

## PCBN

	ISO		Mitsubishi Materials	Sandvik	Seco Tools	Sumitomo Electric	Tungaloy	Kyocera	Dijet
	Klasse	Abkürzung							
Drehen	H	H01	BC8105 BC8110 MB8110	CB7105	CBN060K	BNC100 BNX10 BN1000 BNC2010	BXM10 BX310	KBN05M KBN10M KBN510	
		H10	BC8110 MBC020 BC8120 BC8220 MB8025 MB8110 MB8120	CB7115 CB7015	CBN010	BNC160 BNX20 BN2000 BNC2020	BXM10 BX330 BX530	KBN05M KBN25M KBN525	JBN300
		H20	MBC020 BC8120 BC8220 MB8025 MB8120	CB7125 CB7025 CB20	CBN150 CBN160C	BNC200 BNX25 BN250 BNC2020	BXM20 BXA20 BX360	KBN525 KBN05M KBN25M	JBN245
		H30	BC8130 MB8130	CB7135 CB7525	CBN150 CBN160C	BNC300 BN350	BXC50 BX380	KBN35M	
	S	S01	MB730 MB8025		CBN170	BN700 BN7000	M714B		
		S10				BNS8125	BX470, BX480		
		S20							
		S30							
	K	K01	MB710 BC5110 MB5015			BN500 BNC500	BX870 BX930 BX910		
		K10	MB730 MB4020 MB4120	CB7525		BN700 BN7500 BN7000	BX470 BX480	KBN60M	JBN795
		K20	MB730 MB4020 MB4120		CBN200	BN700 BN7000	BX480	KBN60M	JBN500
		K30	BC5030	CB7925	CBN300 CBN400C CBN500	BNS800 BNC8115, BNC8125	BX90S BXC90	KBN900	
	Sinterlegierungen		MB4020 MB4120		CBN200	BN7500 BN7000 BNC7115	BX470 BX480	KBN570 KBN70M	

## PKD

	ISO		Mitsubishi Materials	Sandvik	Seco Tools	Sumitomo Electric	Tungaloy	Kyocera	Dijet
	Klasse	Abkürzung							
Drehen	N	N01	MD205	CD05	PCD05	DA90	DX180 DX160	KPD001	JDA30 JDA735
		N10	MD220	CD10	PCD10	DA150	DX140	KPD010	
		N20	MD220		PCD20	DA2200	DX120		JDA715
		N30	MD230 MD2030		PCD30 PCD30M	DA1000	DX110	KPD230	JDA10

Hinweis 1) Die Schneidstoffsorten anderer Hersteller wurden der Fachliteratur entnommen und können von Herstellerangaben abweichen.

# SPANBRECHER VERGLEICHSTABELLE

## NEGATIVE WSP

ISO	Bearbeitungsmethode	Mitsubishi Materials	Sandvik	Kennametal	Seco Tools	Sumitomo Electric	Tungaloy	Kyocera	Dijet	MOLDINO	Walter	TaeguTec
<b>P</b>	<b>Schlichten</b>	FH, FP FY, FS	LC	FF	FF1, FF2	FA, FB FL	01* TF, 11 ZF	GP, PP, VF XP, XP-T, XF		FE	FP5	FA FX
	<b>Leicht</b>	LP SA, SH	XF PF MF	K LF, FN	MF2	SU LU, FE SX, SE	PS NS, 27 TSF, AS, TQ	PQ HQ, CQ	PF UR, UA, UT	BE B, BH, CE	MP3, FV5	FM FG
	<b>Leicht (Baustahl)</b>	SY					17	XQ, XS				FC
	<b>Leicht (WIPER)</b>	SW	WL, WF	FW	W-FF2 W-MF2	LUW, SEW	FW, SW AFW, ASW	WF WP, WQ			FW5, NF	WS
	<b>Mittel</b>	MP MA MH	PM QM, XM XMR	MP, P MN	MF3 MF5, M3 M5	GU UG GE, UX	PM, NM, ZM TA, TM, AM, 28 DM, 33, 37, 38	PG, CJ, GS PS, HS PT	PG UB	CT, AB AH, AR AY, AE	MP5, MV5 MU5	PC, MP, FT MT
	<b>Mittel (WIPER)</b>	MW	WMX, WM WR	MW, RW	W-M6, W-M3 W-MF5	GUW		WE			MW5, NM	WT
	<b>Schruppen</b>	RP GH Std.	PR, HM Std.	RN, RP	M6, MR6, MR7	MU, MX, ME UZ	TH, THS Std.	PH GT Std.	UD GG	RE Y	RP5, RP7 RV5	RT Std.
	<b>Schwerzersetzung</b>	HZ HL, HM, HX HV	QR, PR HR, MR	MR, RP RM RH	R4, R5 R57, RR6, R7 R68, RR9	MP HG, HP HU, HW, HF	TRS, 57 TU TUS, 65	PX	UC	HX HE, H	NRF HU5 NRR	RX, RH HD, HY, HT HZ, EH
<b>M</b>	<b>Schlichten Leicht</b>	SH, LM	XF, MF	FF, FP LF*	FF1, FF2 MF1	SU, EF	SS	MQ, SK*		MP, AB, BH	FM5	SF
	<b>Mittel</b>	MS, GM MM, MA ES	MM QM, XM K	MS, MP UP	MF3 MF4 MF5, M3	EX, EG, UP GU HM	SA, SF SM S	MS, MU TK ST	SF, SZ SG	PV, DE, SE AH	MM5, RM5 MU5	ML EM, MM VF
	<b>Schwerzersetzung</b>	GH, RM HL, HZ	MR MR	MR, RP	M5, M6, R6 R56, RR6, R7 R8, PR9	EM, MU MP	TH, SH		AE		HU5	
<b>K</b>	<b>Schlichten Leicht</b>	LK, MA	KF	FN	MF2 M3, M4		CF	KQ		VA, AH	MK5	FG
	<b>Mittel</b>	MK, GK Std.	KM	RP, UN	M5	UZ, GZ, UX	CM Std.	KG, Std., C	PG	V, AE	RK5, MV7	MC
	<b>Schruppen</b>	RK	KR, KRR		MR7			KH, GC, PH	GG	RE	RK7 RV7	KT
	<b>Schwerzersetzung</b>	Glatt		Glatt	MR9 Glatt	Glatt	CH, Glatt	ZS, Glatt	Glatt	Glatt	Glatt	
<b>S</b>	<b>Schlichten</b>	FJ*	SF	FS*, FF	MF1	EF		MQ, SK*			FM5	FA
	<b>Leicht</b>	LS, MJ, MJ*	SGF*	LF*, MS, FN	MF3	SU*	HRF				NFT MS3	EA, SF
	<b>Mittel</b>	MS MA	NGP*, SM QM	UP, P, NGP*	M1 M3	EG, EX, UP	HRM, 28 SA, HMM	SQ MS, MU, TK		VI	NMS, NMT MU5	
	<b>Schwerzersetzung</b>	RS, GJ	SR, SMR	RP	MR3 MR4	MU		SG, SX			NRS, NRT HU5	ET

\*Geschliffene WSP (G-Toleranz)

Hinweis 1) Die Informationen anderer Hersteller wurden der Fachliteratur entnommen und können Abweichen.

## 7° POSITIVE WSP

ISO	Bearbeitungs methode	Mitsubishi Materials	Sandvik	Kennametal	Seco Tools	Sumitomo Electric	Tungaloy	Kyocera	Dijet	MOLDINO	Walter	TaeguTec
P	Schichten	SMG*	UM*	LF*		FC*, SC*	JS*, 01*	CF*, CK* GQ*, GF* SKS*, SK*			FP2*	SA*
	Schichten Leicht	FP, FV LP, SV	PF, UF	UF, 11 LF, FP	FF1 F1, MF2	FB, FP, LU LB, SU	PF, PSF PS, PSS, TSF	GP, PP, VF XP		JQ	PF4, FP4	FA, FX FG
	Leicht (WIPER)	SW	WF	FW	W-F1	LUW, SDW		WP			PF	
	Mittel	MV MP, Std.	PM, UM PR, UR	MF, MP	M3 F2, M5	GU MU	TM, 23 PM, 24	HQ, MF* XQ, GK	FT	JE	FP6, MP4 RP4	PC MT
	Mittel (WIPER)	MW	WM	MW	W-MF2 W-M3		SW				PM	WT
M	Schichten Leicht	FM LM	MF, UF	LF, UF FP	F1, F2 MF2	FC*, SI* LU LB, SU	PF, PSF PS, PSS	CF*, CK* GQ*, GF* MQ*, SK*		MP	FM2* FM4	FA FG
	Mittel	MM, Std.	MM, UM MR, UR	MP	M3 M5	GU, MU	PM	HQ, GK			FM6 MM4, RM4	PC MT
K	Mittel	MK, Std. Glatt	KF, KM, UM, KR	Glatt	F1, M3, M5	MU, Glatt*	Glatt, CM	Glatt*			FK6, MK4 RK4, RK6	MT
N	Mittel	AZ*	AL*	HP*	AL*	AG* AW*	AL*	AP* AH*	ASF*, ALU* ACB*		FN2*, PM2* MN2*	FL*
S	Schichten Leicht	FS*, LS* FS-P*, LS-P* FJ* LS, MS	UM* UF, MF UM, MM	LF* HP*		SI* GU	Std.	CF*, CK* GQ*, GF* SK*, MQ			FM2* FM4, FM6 MM4, RM4	SA*, FA, FG PC, MT

\*Geschliffene WSP (G-Toleranz)

Hinweis 1) Die Informationen anderer Hersteller wurden der Fachliteratur entnommen und können Abweichen.

## 11° POSITIVE WSP

ISO	Bearbeitungs methode	Mitsubishi Materials	Sandvik	Kennametal	Seco Tools	Sumitomo Electric	Tungaloy	Kyocera	Dijet	MOLDINO	Walter	TaeguTec
P	Schichten Leicht	FV, SMG* SV	PF	UF, FP FW, LF		SI, FK, FB LU, LUW, LB SU, SF	01* PF, PSF PS, PSS, TSF	PP, GP, GF* SKS*, CF*, CK* PF*, XP		JQ	FP4	FG PC
	Mittel	MV	PM, UM	MF MP, MW		GU, MU, US	PM TM, 23 24	HQ XQ	BM	JE	MP4	
M	Schichten Leicht	SMG* SV	MF	HP* LF		SU	SS* PF, PS	GF*, CK* PF*, GP, CF* SKS*		MP	FM4	PC
	Mittel	MV	MM			GU, MU, US	PM, Std.	HQ			MM4	

\*Geschliffene WSP (G-Toleranz)

Hinweis 1) Die Informationen anderer Hersteller wurden der Fachliteratur entnommen und können Abweichen.

P

TECHNISCHE DATEN

# Notizen

---

A series of horizontal dashed lines for taking notes, spanning the width of the page.



# INHALTSVERZEICHNIS

## INHALTSVERZEICHNIS FÜR WERKZEUGBEZEICHNUNG

A.....	2
B.....	2
C.....	2
D.....	4
E.....	4
F.....	4
G.....	5
H.....	5
J.....	6
K.....	6
L.....	6
M.....	6
N.....	7
P.....	7
R.....	7
S.....	8
T.....	9
U.....	10
V.....	10
W.....	10
X.....	11

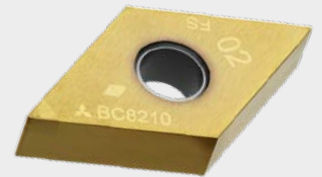
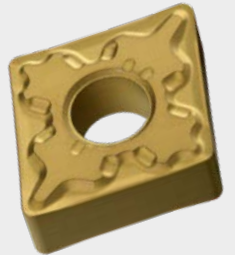

# INHALTSVERZEICHNIS FÜR WERKZEUGBEZEICHNUNG

Bestellbezeichnung	PRODUKTNAME	Seite	Bestellbezeichnung	PRODUKTNAME	Seite
<b>A</b>			<b>CB00RS-B</b> .....	MICRO-MINI TWIN.....	E021
<b>A000-DCLNR/L12</b> .....	DIMPLE BAR-Bohrstange.....	E015	<b>CB00RS-00B</b> .....	MICRO-MINI TWIN.....	E021
<b>A000-DDUNR/L15</b> .....	DIMPLE BAR-Bohrstange.....	E015	<b>CBS0</b> .....	Spanbrecher.....	N017
<b>A000-DSKNR/L12</b> .....	DIMPLE BAR-Bohrstange.....	E016	<b>CBS00</b> .....	Spanbrecher.....	N017
<b>A000-DTFNR/L16</b> .....	DIMPLE BAR-Bohrstange.....	E016	<b>CBT0</b> .....	Spanbrecher.....	N017
<b>A000-DVUNR/L16</b> .....	DIMPLE BAR-Bohrstange.....	E017	<b>CBT00</b> .....	Spanbrecher.....	N017
<b>A000-DWLNRL/00</b> .....	DIMPLE BAR-Bohrstange.....	E017	<b>CBT0000</b> .....	Spanbrecher.....	N017
<b>AJS0000T00</b> .....	Spannschraube.....	N003	<b>CCET000000R/L-SN</b> .....	WSP (E Toleranz).....	A145
<b>AMS0</b> .....	Spannpratze.....	N015	<b>CCET000000R/L-SR</b> .....	WSP (E Toleranz).....	A143, A144
<b>A000PCLNR/L00</b> .....	P Bohrstange.....	E038	<b>CCET000000R/LW-SN</b> .....	WSP (E Toleranz).....	A145
<b>A000PDQNR/L15</b> .....	P Bohrstange.....	E039	<b>CCGH000000MR/L-F</b> .....	WSP (G Toleranz).....	A141
<b>A000PDUNR/L00</b> .....	P Bohrstange.....	E038	<b>CCGH000000R/L-F</b> .....	WSP (G Toleranz).....	A140
<b>A000PDZNR/L15</b> .....	P Bohrstange.....	E040	<b>CCGT000000-AZ</b> .....	WSP (G Toleranz).....	A140
<b>A000PSKNR/L00</b> .....	P Bohrstange.....	E037	<b>CCGT000000-FJ</b> .....	WSP (G Toleranz).....	A139
<b>A000PTFNR/L00</b> .....	P Bohrstange.....	E037	<b>CCGT000000-LF</b> .....	WSP (G Toleranz).....	A140
<b>A000PWLNR/L06</b> .....	P Bohrstange.....	E039	<b>CCGT000000-LS</b> .....	WSP (G Toleranz).....	A141
<b>ASS0</b> .....	Feder (Für AJAX/BRE/CV Fräser).....	C032	<b>CCGT000000M-FS</b> .....	WSP (G Toleranz).....	A139
<b>B</b>			<b>CCGT000000M-FS-P</b> .....	WSP (G Toleranz).....	A139
<b>BCP000</b> .....	Befestigungsfeder.....	N014	<b>CCGT000000M-LS</b> .....	WSP (G Toleranz).....	A141
<b>BF-CCGT000000002</b> .....	WSP (G Toleranz).....	B052	<b>CCGT000000M-LS-P</b> .....	WSP (G Toleranz).....	A141
<b>BF-CNGM00000000WS2</b> .....	WSP (G Toleranz).....	B038	<b>CCGT000000MR/L-F</b> .....	WSP (G Toleranz).....	A141
<b>BF-CNGM000000002</b> .....	WSP (G Toleranz).....	B038	<b>CCGT000000MR/L-SN</b> .....	WSP (G Toleranz).....	A144
<b>BF-DCGT000000002</b> .....	WSP (G Toleranz).....	B055	<b>CCGT000000MR/L-SS</b> .....	WSP (G Toleranz).....	A142
<b>BF-DNGM000000002</b> .....	WSP (G Toleranz).....	B042	<b>CCGT000000R/L-SN</b> .....	WSP (G Toleranz).....	A144
<b>BF-DNGM00000000WS2</b> .....	WSP (G Toleranz).....	B042	<b>CCGT000000R/L-SS</b> .....	WSP (G Toleranz).....	A142
<b>BM-CCGT000000002</b> .....	WSP (G Toleranz).....	B052	<b>CCGT000000-SMG</b> .....	WSP (G Toleranz).....	A145
<b>BM-CNGM000000002</b> .....	WSP (G Toleranz).....	B038	<b>CCGW000000</b> .....	WSP (G Toleranz).....	A145
<b>BM-DCGT000000002</b> .....	WSP (G Toleranz).....	B055	<b>CCK00</b> .....	Spannpratze.....	N015
<b>BM-DNGM000000002</b> .....	WSP (G Toleranz).....	B042	<b>CCMH000000-MV</b> .....	WSP (M Toleranz).....	A143
<b>BM-TNGM000000003</b> .....	WSP (G Toleranz).....	B045	<b>CCMH000000-SV</b> .....	WSP (M Toleranz).....	A141
<b>BOES101</b> .....	Schrauben.....	N009	<b>CCMT000000</b> .....	WSP (M Toleranz).....	A143
<b>BPT322</b> .....	Unterlegplatte.....	N011	<b>CCMT000000-FM</b> .....	WSP (M Toleranz).....	A139
<b>BRS000</b> .....	Spannschraube.....	N003	<b>CCMT000000-FP</b> .....	WSP (M Toleranz).....	A139
<b>BTahr/L0000-50</b> .....	Small Tools Halter (Aussen Längsdrehen, Rückwärtsdrehen).....	D014	<b>CCMT000000-FV</b> .....	WSP (M Toleranz).....	A139
<b>BTAT000000R/L-B</b> .....	WSP für Small Tools Halter.....	D014	<b>CCMT000000-LM</b> .....	WSP (M Toleranz).....	A141
<b>BTAT605000RX</b> .....	WSP für Small Tools Halter.....	D014	<b>CCMT000000-LP</b> .....	WSP (M Toleranz).....	A141
<b>BTBT000000R/L-B</b> .....	WSP für Small Tools Halter.....	D015	<b>CCMT000000-LS</b> .....	WSP (M Toleranz).....	A141
<b>BTBT606000R/L</b> .....	WSP für Small Tools Halter.....	D015	<b>CCMT000000-MK</b> .....	WSP (M Toleranz).....	A143
<b>BTVHR00000-750</b> .....	Small Tools Halter (Aussen Längsdrehen, Rückwärtsdrehen).....	D016	<b>CCMT000000-MM</b> .....	WSP (M Toleranz).....	A142
<b>BTVT000000R-B</b> .....	WSP für Small Tools Halter.....	D016	<b>CCMT000000-MP</b> .....	WSP (M Toleranz).....	A142
<b>C</b>			<b>CCMT000000-MS</b> .....	WSP (M Toleranz).....	A143
<b>CA000</b> .....	Spannpratze.....	N015	<b>CCMT000000-MW</b> .....	WSP (M Toleranz).....	A143
<b>CAS51T</b> .....	Schrauben.....	N003	<b>CCMT000000-SW</b> .....	WSP (M Toleranz).....	A141
<b>CB00RS</b> .....	MICRO-MINI TWIN.....	E021	<b>CCMW000000</b> .....	WSP (M Toleranz).....	A145, B068
<b>CB00RS-00</b> .....	MICRO-MINI TWIN.....	E021	<b>CCP00</b> .....	Befestigungsfeder.....	N014
			<b>CCTC1</b> .....	Spannpratze.....	N015
			<b>C00FR-BLS</b> .....	MICRO-MINI Bohrstange (Vollhartmetall).....	E024, F126
			<b>CG00RS-000</b> .....	MICRO-MINI TWIN.....	F127
			<b>CG0000RS-000</b> .....	MICRO-MINI TWIN.....	F127

Bestellbezeichnung	PRODUKTNAME	Seite	Bestellbezeichnung	PRODUKTNAME	Seite
C <sup>0</sup> -GYHER/LM00-M25R/L	GY PSC Aufnahmen	F090	CPMH <sup>0000000000</sup> -FV	WSP (M Toleranz)	A146
C <sup>0</sup> -GYHER/LM50-M25R/L	GY PSC Aufnahmen	F094	CPMH <sup>0000000000</sup> -MV	WSP (M Toleranz)	A146
C <sup>0</sup> -GYHER/LM90-M25R/L	GY PSC Aufnahmen	F092	CPMH <sup>0000000000</sup> R/L-F	WSP (M Toleranz)	A146
C <sup>00</sup> HR-BLS	MICRO-MINI Bohrstange (Vollhartmetall)	E024, F126	CPMH <sup>0000000000</sup> -SV	WSP (M Toleranz)	A146
CK <sup>0000</sup>	Spannpratze	N015	CPMX <sup>0000000000</sup>	WSP (M Toleranz)	A146
CKW6	Spannpratze	N016	CPT <sup>000</sup>	Seitl. Anlegeplatte	C016—C018, C023
CNGA <sup>0000000000</sup>	WSP (G Toleranz)	B038	CR <sup>0</sup>	Sprengring	G012, G013, H016
CNGG <sup>0000000000</sup> -FJ	WSP (G Toleranz)	A098	CR <sup>000</sup> RS- <sup>000</sup>	MICRO-MINI TWIN	E022
CNGG <sup>0000000000</sup> -MJ	WSP (G Toleranz)	A099	CR <sup>000</sup> RS- <sup>000</sup> B	MICRO-MINI TWIN	E022
CNGN <sup>0000000000</sup>	WSP (G Toleranz)	B049	CS <sup>000</sup>	Unterlegplatte	N011
CNMA <sup>0000000000</sup>	WSP (M Toleranz)	A104, B064	CS1/8- <sup>0000000000</sup>	Kühlmittelschlauch-Kit	F121
CNMG <sup>0000000000</sup>	WSP (M Toleranz)	A102	C <sup>0000</sup> SCLCR <sup>000</sup>	MICRO-DEX Bohrstange, S Bohrstange (Hartmetallschaft)	E018, E032
CNMG <sup>0000000000</sup> -FH	WSP (M Toleranz)	A098	C <sup>0000</sup> SDQCR <sup>000</sup>	S Bohrstange (Hartmetallschaft)	E033
CNMG <sup>0000000000</sup> -FP	WSP (M Toleranz)	A098	C <sup>0000</sup> SDUCR <sup>000</sup>	S Bohrstange (Hartmetallschaft)	E031
CNMG <sup>0000000000</sup> -FS	WSP (M Toleranz)	A098	CSF401260T	Spannschraube	N003
CNMG <sup>0000000000</sup> -FY	WSP (M Toleranz)	A098	CS <sup>0000</sup> T	Spannschraube	N003
CNMG <sup>0000000000</sup> -GH	WSP (M Toleranz)	A103	CS <sup>0000000000</sup> T	Spannschraube	N003
CNMG <sup>0000000000</sup> -GJ	WSP (M Toleranz)	A103	CS <sup>0000000000</sup> T	Spannschraube	N003
CNMG <sup>0000000000</sup> -GK	WSP (M Toleranz)	A101	C <sup>0000</sup> STFCR <sup>000</sup>	S Bohrstange (Hartmetallschaft)	E030
CNMG <sup>0000000000</sup> -GM	WSP (M Toleranz)	A101	CS <sup>0000000000</sup> TS	Spannschraube	N003
CNMG <sup>0000000000</sup> -LK	WSP (M Toleranz)	A099	C <sup>0000</sup> STUCR06	MICRO-DEX Bohrstange (Hartmetallschaft)	E019
CNMG <sup>0000000000</sup> -LM	WSP (M Toleranz)	A098	CSVHR/L <sup>0000000000</sup>	Small Tools Halter (Für Längsdrehautomaten)	D027
CNMG <sup>0000000000</sup> -LP	WSP (M Toleranz)	A098	C <sup>0000</sup> SVQCR <sup>000</sup>	S Bohrstange (Hartmetallschaft)	E034
CNMG <sup>0000000000</sup> -LS	WSP (M Toleranz)	A099	CSVTB <sup>0000000000</sup> R-B	WSP für Small Tools Halter	D028
CNMG <sup>0000000000</sup> -MA	WSP (M Toleranz)	A101	CSVTB <sup>0000000000</sup> R/L	WSP für Small Tools Halter	D028
CNMG <sup>0000000000</sup> -MH	WSP (M Toleranz)	A101	CSVTBXL	WSP für Aussen Rückwärtsdrehen, Kopieren	D028
CNMG <sup>0000000000</sup> -MJ	WSP (M Toleranz)	A099	CSVTC <sup>0000000000</sup> R-B	WSP für Aussen Abstechen	D028
CNMG <sup>0000000000</sup> -MK	WSP (M Toleranz)	A100	CSVTC <sup>0000000000</sup> R/L	WSP für Aussen Abstechen	D028
CNMG <sup>0000000000</sup> -MM	WSP (M Toleranz)	A100	CSVTF <sup>0000000000</sup> R/L	WSP für Aussen Längsdrehen	D027
CNMG <sup>0000000000</sup> -MP	WSP (M Toleranz)	A100	CSVTF <sup>0000000000</sup> R/L-B	WSP für Aussen Längsdrehen	D027
CNMG <sup>0000000000</sup> -MS	WSP (M Toleranz)	A100, A101	CSVTFXL	WSP für Aussen Längsdrehen, Kopieren	D027
CNMG <sup>0000000000</sup> -MW	WSP (M Toleranz)	A102	CSVTG <sup>0000000000</sup> R/L	WSP für Einstechen	D029
CNMG <sup>0000000000</sup> -RK	WSP (M Toleranz)	A103	CSVTT60050RR/L	WSP für Gewindedrehen	D029
CNMG <sup>0000000000</sup> -RM	WSP (M Toleranz)	A102	C <sup>0000</sup> SWUBR <sup>000</sup>	MICRO-DEX Bohrstange (Hartmetallschaft)	E018
CNMG <sup>0000000000</sup> -RP	WSP (M Toleranz)	A102	CT <sup>000</sup>	Unterlegplatte	N011
CNMG <sup>0000000000</sup> -RS	WSP (M Toleranz)	A103	CTAHR/L <sup>0000000000</sup> -120	Small Tools Halter (Aussen Abstechen)	D020
CNMG <sup>0000000000</sup> -SA	WSP (M Toleranz)	A099	CTAHR1010-120S	Small Tools Halter (Aussen Abstechen)	D020
CNMG <sup>0000000000</sup> -SH	WSP (M Toleranz)	A099	CTAT <sup>0000000000000000</sup> -B	WSP (Abstechen)	D021
CNMG <sup>0000000000</sup> -SW	WSP (M Toleranz)	A099	CTAT <sup>0000000000000000</sup> -BX	WSP (Abstechen)	D021
CNMG <sup>0000000000</sup> -SY	WSP (M Toleranz)	A099	CTAT <sup>0000000000000000</sup> LL/RR	WSP (Abstechen)	D021
CNMM <sup>0000000000</sup> -HL	WSP (M Toleranz)	A103	CTBHR/L <sup>0000000000</sup> -160	Small Tools Halter (Aussen Rückwärtsdrehen, Abstechen)	D015, D022
CNMM <sup>0000000000</sup> -HM	WSP (M Toleranz)	A104	CTBT <sup>0000000000000000</sup> -B	WSP (Abstechen)	D022
CNMM <sup>0000000000</sup> -HR	WSP (M Toleranz)	A104	CTE <sup>0000</sup> TN/P <sup>000</sup>	Unterlegplatte (Für MMTE-Halter)	G019
CNMM <sup>0000000000</sup> -HV	WSP (M Toleranz)	A104	CTI <sup>0000</sup> TN/P <sup>000</sup>	Unterlegplatte (Für MMTI-Halter)	G026
CNMM <sup>0000000000</sup> -HX	WSP (M Toleranz)	A103			
CNMM <sup>0000000000</sup> -HZ	WSP (M Toleranz)	A104			
CNMN <sup>0000000000</sup>	WSP (M Toleranz)	A136			
CPGT <sup>0000000000</sup>	WSP (G Toleranz)	A146, B067			
CPGT <sup>0000000000</sup> R/L-F	WSP (G Toleranz)	A146			

# INHALTSVERZEICHNIS FÜR WERKZEUGBEZEICHNUNG

Bestellbezeichnung	PRODUKTNAME	Seite	Bestellbezeichnung	PRODUKTNAME	Seite
CT00RS-M00	MICRO-MINI TWIN	G031	DNGN000000	WSP (G Toleranz)	B049
CT32T1	Unterlegplatte	N012	DNMA000000	WSP (M Toleranz)	A111
<b>D</b>					
DCET000000R/L-SN	WSP (E Toleranz)	A151, A152	DNMG000000	WSP (M Toleranz)	A109
DCET000000R/L-SR	WSP (E Toleranz)	A150, A151	DNMG000000-FH	WSP (M Toleranz)	A105
DCET000000R/LW-SN	WSP (E Toleranz)	A152	DNMG000000-FP	WSP (M Toleranz)	A105
DCGT000000-AZ	WSP (G Toleranz)	A147	DNMG000000-FS	WSP (M Toleranz)	A105
DCGT000000M-FS	WSP (G Toleranz)	A147	DNMG000000-FY	WSP (M Toleranz)	A105
DCGT000000M-FS-P	WSP (G Toleranz)	A147	DNMG000000-GH	WSP (M Toleranz)	A110
DCGT000000M-LS	WSP (G Toleranz)	A148	DNMG000000-GJ	WSP (M Toleranz)	A110
DCGT000000M-LS-P	WSP (G Toleranz)	A149	DNMG000000-GK	WSP (M Toleranz)	A108
DCGT000000MR/L-SN	WSP (G Toleranz)	A151	DNMG000000-GM	WSP (M Toleranz)	A108
DCGT000000MR/L-SS	WSP (G Toleranz)	A149	DNMG000000-LK	WSP (M Toleranz)	A106
DCGT000000MR-SRF	WSP (G Toleranz)	A141	DNMG000000-LM	WSP (M Toleranz)	A106
DCGT000000R/L-F	WSP (G Toleranz)	A148	DNMG000000-LP	WSP (M Toleranz)	A106
DCGT000000R/L-SN	WSP (G Toleranz)	A151	DNMG000000-LS	WSP (M Toleranz)	A106
DCGT000000R/L-SS	WSP (G Toleranz)	A149	DNMG000000-MA	WSP (M Toleranz)	A109
DCGT000000SMG	WSP (G Toleranz)	A152	DNMG000000-MH	WSP (M Toleranz)	A109
DCGW000000	WSP (G Toleranz)	A152	DNMG000000-MJ	WSP (M Toleranz)	A107
DCK00000	Spannpratze	N016	DNMG000000-MK	WSP (M Toleranz)	A108
DCLNR/L0000000	Doppelklemm-Halter	C008	DNMG000000-MM	WSP (M Toleranz)	A107
DCLNR/L00000000-T	Doppelklemm-Halter	C008	DNMG000000-MP	WSP (M Toleranz)	A107
DCMT000000	WSP (M Toleranz)	A150	DNMG000000-MS	WSP (M Toleranz)	A108
DCMT000000-FM	WSP (M Toleranz)	A147	DNMG000000-RK	WSP (M Toleranz)	A110
DCMT000000-FP	WSP (M Toleranz)	A147	DNMG000000-RM	WSP (M Toleranz)	A110
DCMT000000-FV	WSP (M Toleranz)	A147	DNMG000000-RP	WSP (M Toleranz)	A109
DCMT000000-LM	WSP (M Toleranz)	A148	DNMG000000-RS	WSP (M Toleranz)	A110
DCMT000000-LP	WSP (M Toleranz)	A148	DNMG000000-SA	WSP (M Toleranz)	A107
DCMT000000-LS	WSP (M Toleranz)	A148	DNMG000000-SH	WSP (M Toleranz)	A106
DCMT000000-MK	WSP (M Toleranz)	A150	DNMG000000-SY	WSP (M Toleranz)	A107
DCMT000000-MM	WSP (M Toleranz)	A149	DNMM000000-HL	WSP (M Toleranz)	A110
DCMT000000-MP	WSP (M Toleranz)	A149	DNMM000000-HZ	WSP (M Toleranz)	A111
DCMT000000-MS	WSP (M Toleranz)	A150	DNMX000000-MW	WSP (M Toleranz)	A109
DCMT000000-MV	WSP (M Toleranz)	A150	DNMX000000-SW	WSP (M Toleranz)	A107
DCMT000000-SV	WSP (M Toleranz)	A149	DTGNR/L00000016	Doppelklemm-Halter	C016
DCMW000000	WSP (M Toleranz)	A152, B068	DTGNR/L00000016-T	Doppelklemm-Halter	C016
DCS0	Feder	C008, C010, C017, C019–C022 E015–E017, H006–H011	DVJNR/L00000016	Doppelklemm-Halter	C019
DCSVN32	Unterlegplatte	N011	DVPNR/L00000016	Doppelklemm-Halter	C021
DC00000T	Spannschraube	N003	DVVNN00000016	Doppelklemm-Halter	C020
DDJNR/L00000000	Doppelklemm-Halter	C010	DWLNR/L00000000	Doppelklemm-Halter	C022
DDJNR/L00000015-T	Doppelklemm-Halter	C010	DWLNR/L00000006-T	Doppelklemm-Halter	C022
DEGX000000R/L	WSP (Für AL-Halter)	A153	<b>E</b>		
DEGX000000R/L-F	WSP (Für AL-Halter)	A153, B073	E00	Anschlagring	C019–C021
DKS0	Spannschraube	N003	EGS000000	Spannschraube	N004
DNGA000000	WSP (G Toleranz)	A111, B064	ESS42	Unterlegplatte	N011
DNGG000000-FJ	WSP (G Toleranz)	A105	EST00	Unterlegplatte	N011
DNGG000000R/L	WSP (G Toleranz)	A109	<b>F</b>		
DNGM000000-MJ	WSP (G Toleranz)	A107	FCTU0000R/L	FCTU Bohrstange	E028
			FC400890T	Spannschraube	N004

Bestellbezeichnung	PRODUKTNAME	Seite	Bestellbezeichnung	PRODUKTNAME	Seite
FSCLC1008R/L-06A	DIMPLE BAR	E007	GYHR/L0000000090-M00R/L	GY Halter	F032–F036, F072–F080
FSCLC1008R/L-06E	DIMPLE BAR (Hartmetallschaft)	E008	GYM00R/LC-0005	Modulares Schwert	F038, F095
FSCLC1008R-06E-0/0	DIMPLE BAR (Hartmetallschaft)	E008	GYM00R/L0-D00	Modulares Schwert	F018, F032, F082, F090–F093, F095
FSCLP00000R-00E-0/0	DIMPLE BAR (Hartmetallschaft)	E008	GYM00R/L0-D00-000	Modulares Schwert	F040–F044, F072
FSCLP00000R/L-00A	DIMPLE BAR	E007	GYM00R/L0-E00	Modulares Schwert	F020, F032, F084, F090–F093
FSCLP00000R/L-00E	DIMPLE BAR (Hartmetallschaft)	E008	GYM00R/L0-E00-000	Modulares Schwert	F044–F046, F072
FSDQC00000R/L-00A	DIMPLE BAR	E011	GYM00R/L0-F00	Modulares Schwert	F022, F034, F086, F090–F093
FSDQC00000R/L-00E	DIMPLE BAR (Hartmetallschaft)	E011	GYM00R/L0-F00-000	Modulares Schwert	F048–F054, F074
FSDUC00000R/L-00A	DIMPLE BAR	E010	GYM00R/L0-G00	Modulares Schwert	F024, F034, F086, F090–F093
FSDUC00000R/L-00E	DIMPLE BAR (Hartmetallschaft)	E010	GYM00R/L0-G00-000	Modulares Schwert	F056–F060, F076
FSTUP00000R-00E-0/0	DIMPLE BAR (Hartmetallschaft)	E009	GYM00R/L0-H00	Modulares Schwert	F026, F036, F088, F090–F093
FSTUP00000R/L-00A	DIMPLE BAR	E009	GYM00R/L0-H00-000	Modulares Schwert	F062–F066, F078
FSTUP00000R/L-00E	DIMPLE BAR (Hartmetallschaft)	E009	GYM00R/L0-J00	Modulares Schwert	F028, F036, F088, F090–F093
FSTU0000R/L	FSTU Bohrstange	E027	GYM00R/L0-J00-000	Modulares Schwert	F068–F070, F080
FSVJB00000R/L-11S	DIMPLE BAR	E014	GYPR/L00000000-K00	GY Halter	F030
FSVJC00000R/L-08S	DIMPLE BAR	E014	GYQR/L00000000-D00	GY Halter	F018
FSVPB00000R/L-00A	DIMPLE BAR	E013	GYQR/L00000000-F00	GY Halter	F022
FSVPC00000R/L-08A	DIMPLE BAR	E013	GYQR/L00000000-G00	GY Halter	F024
FSVUB00000R/L-00A	DIMPLE BAR	E013	GYQR/L00000000-H00	GY Halter	F026
FSVUC00000R/L-08A	DIMPLE BAR	E013	GYQR/L00000000-J00	GY Halter	F028
FSWL0000R/L0	FSWL Bohrstange	E029	GY05016S	Spannschraube	N004
FSWUB00000R/L-L3A	DIMPLE BAR	E012	GY06013M	Spannschraube	N004
FSWUB00000R/L-L3E	DIMPLE BAR (Hartmetallschaft)	E012	GY1B000000000N	WSP (Für GY Halter)	F015
FSWUB00000R-L3E-0/0	DIMPLE BAR (Hartmetallschaft)	E012	GY1G000000000-GFGS	WSP (Für GY Halter)	B063, F013
FSWUP00000R-00E-0/0	DIMPLE BAR (Hartmetallschaft)	E012	GY1M000000000N-GM	WSP (Für GY Halter)	F012
FSWUP00000R/L-00A	DIMPLE BAR	E012	GY1M000000000R/L05-GM	WSP (Für GY Halter)	F012
FSWUP00000R/L-00E	DIMPLE BAR (Hartmetallschaft)	E012	GY2B000000000N	WSP (Für GY Halter)	F015
<b>G</b>			GY2G000000000N-MF	WSP (Für GY Halter)	F014
GT0HR/L000000000	Small Tools Halter (Aussen Einstechen)	D018	GY2G000000000005N-GL	WSP (Für GY Halter)	F013
GT0TR/L	WSP (Rohling)	D019	GY2M000000000N-BM	WSP (Für GY Halter)	F015
GT0T000000000R/L-E	WSP (Aussen Einstechen)	D019	GY2M000000000N-GM	WSP (Für GY Halter)	F012
GT0T000000000R/L-U	WSP (Aussen Einstechen)	D018	GY2M000000000N-GS	WSP (Für GY Halter)	F012
GT0T000000000R-VT	WSP (Aussen Einstechen)	D019	GY2M000000000N-GU	WSP (Für GY Halter)	F012
GWB00NA2-000	GW Halter	F118	GY2M000000000N-MM	WSP (Für GY Halter)	F014
GWB00NA2-000-C	GW Halter	F118	GY2M000000000N-MS	WSP (Für GY Halter)	F014
GWTBN200000-B00	Block (Für GW Halter)	F119	GY2M000000000R/L05-GM	WSP (Für GY Halter)	F013
GWTBN200000-B00-C	Block (Für GW Halter)	F119	<b>H</b>		
GW1B00000020N	WSP (Für GW Halter)	F120	HBH000000	Spannschraube	N002
GW1M000000000N-00	WSP (Für GW Halter)	F120	HBHA000000	Spannschraube	N002
GW1M000000000R-00-GS	WSP (Für GW Halter)	F120	HDS000000	Spannschraube	N009
GW1M000000000R/L05-GM	WSP (Für GW Halter)	F120	HFF06015	Spannschraube	N004
GYAR/L0000090-D00	GY Bohrstange	F082	HFF08000H	Spannschraube	N009
GYAR/L0000090-E00	GY Bohrstange	F084	HGM-PT0/0	Stopfen	E037–E040
GYAR/L0000090-F00	GY Bohrstange	F086	H007, H010, H012, H013, H016, H019		
GYAR/L0000090-G00	GY Bohrstange	F086			
GYAR/L0000090-H00	GY Bohrstange	F088			
GYDR/L0000090-M00R/L	GY Halter	F082–F088			
GYHR/L0000000-M00R/L	GY Halter	F018–F028, F040–F070			
GYHR/L000000050-M00R/L	GY Halter	F038			



# INHALTSVERZEICHNIS FÜR WERKZEUGBEZEICHNUNG

Bestellbezeichnung	PRODUKTNAME	Seite	Bestellbezeichnung	PRODUKTNAME	Seite
HKY○○D	Schlüssel	N002	KS○○	Schrauben	N004
HKY○○F	Schlüssel	N002	KSN○	Spannschraube	N010
HKY○○L	L-Schlüssel	N002	KSN3	Mini-Einstellmutter	N010
HKY○○R	L-Schlüssel	N002	KS○S	Schrauben	N004
HKY○○T	T-Schlüssel	N002	KSS○	Spannschraube	N010
HKY○○W	Schlüssel	N002	KSS2	Große Einstellmutter	N010
HP○○	Excenter	E037–E040	<b>L</b>		
HS○○	Spannschraube	N004	LLK1	Spannpratze	N016
HSC○○○○○	Spannschraube	N002, N009	LLCL○○○	Kniehebel	N014
HSC○○○○○H	Schrauben	N009	LLCL○○S	Kniehebel	N014
HSCX○○○○○H	Schrauben	N009	LLCS○○○	Spannschraube	N005
HSP05008C	Verriegelungsschraube	N004	LLCS○○○S	Spannschraube	N005
HSS○○○○○	Spannschraube	N002	LLP○○	Befestigungsfeder	N014
HY○	Schraube	N004	LLR○	Radial Schraube	N004
HY-A1	Schraube	N004	LLSCN○○	Unterlegplatte	N011
HY-V1	Schraube	N004	LLSCN○T○	Unterlegplatte	N011
H100TH-B○○○○○	HSK Halter (Bohrstangen)	H022	LLSCP○○	Unterlegplatte	N011
H100TH-EN3232R/L-130	HSK Halter Drehen Aussen	H020	LLSDN○○	Unterlegplatte	N011
H100TH-EV3232R/L-180	HSK Halter Drehen Aussen	H019	LLSDP42	Unterlegplatte	N011
H63TH-A○○○DCLNR/L12	HSK DCLN Halter	H008	LLSRN○○○	Unterlegplatte	N011
H63TH-B○○○○○	HSK Halter (Bohrstangen)	H021	LLSSN○○	Unterlegplatte	N011
H63TH-DCLNL-L12-3	HSK DCLN Halter	H008	LLSSP42	Unterlegplatte	N011
H63TH-DCLNR/L-DX12	HSK DCLN Halter	H006	LLSTE32	Unterlegplatte	N012
H63TH-DCMNN-H/L12	HSK DCMN Halter	H007	LLSTN○○	Unterlegplatte	N012
H63TH-DDJNL-L15-3	HSK DDJN Halter	H011	LLSTP○○	Unterlegplatte	N012
H63TH-DDJNR/L-DX15	HSK DDJN Halter	H009	LLSWN○○○	Unterlegplatte	N012
H63TH-DDNNN-H/L15	HSK DDNN Halter	H010	LLSWN○T○	Unterlegplatte	N012
H63TH-EN2525R/L-115	HSK Halter Drehen Aussen	H020	LLSWP○○	Unterlegplatte	N012
H63TH-EV2020R/L-105-3	HSK Halter Drehen Aussen	H021	LS○	Spannschraube	N005
H63TH-EV2525R/L-112	HSK Halter Drehen Aussen	H019	LS○○	Spannschraube	N005
H63TH-MGHR/L-DX○○○○	HSK MG Halter	H014	LS○○T	Spannschraube	N005
H63TH-MMTENR-H/L16	HSK MMT Halter	H016	LS○○○T	Spannschraube	N005
H63TH-MMTER-DX16	HSK MMT Halter	H016	LS10TS	Spannschraube	N005
H63TH-MTHR/L-DX43	HSK MT Halter	H017	LS24H	Spannschraube	N005
H63TH-PCLNR/L-DX12	HSK PCLN Halter	H006	<b>M</b>		
H63TH-PCMNN-H/L12	HSK PCMN Halter	H007	MBA○○○○○H	Spannschraube	N009
H63TH-PDJNR/L-DX15	HSK PDJN Halter	H009	MCLNR○○○○○19	Doppelklemm-Halter	C009
H63TH-PDNNN-H/L15	HSK PDNN Halter	H010	MES○	Feder	C016–C018, C023, F120, G022, H014, H017
H63TH-PRDCN-H/L12	HSK PRDC Halter	H012	MGHR/L○○○○○○○○○○	MG Halter	F124
H63TH-PRGCR/L-DX12	HSK PRGC Halter	H012	MGS6	Spannschraube	N005
H63TH-SVPBR/L-DX16	HSK SVPB Halter	H013	MGTR/L○○○○○	WSP (Für MG Halter)	F125, F133
H63TH-SVVBH-H/L16	HSK SVVB Halter	H013	MHK5NR/L	Spannpratze	N016
<b>J</b>			MHS○○○R/L	Unterlegplatte	N012
JSS○	Schraube	N004	MHT1	Spannschraube	N005
<b>K</b>			MK1K	Kupferpasten	N018
KGC1	Spannpratze	N016	MK1KS	Kupferpasten	N018
KNUX○○○○○○○R/L-M○	WSP (U Toleranz)	A135	MLCP42	Unterlegplatte	N012
KS○	Axial Schraube	N004			





# INHALTSVERZEICHNIS FÜR WERKZEUGBEZEICHNUNG

Bestellbezeichnung	PRODUKTNAME	Seite	Bestellbezeichnung	PRODUKTNAME	Seite
RCMT0000M0	WSP (M Toleranz)	A154	SNMG000000-FS	WSP (M Toleranz)	A113
RCMX0000M0	WSP (M Toleranz)	A154	SNMG000000-GH	WSP (M Toleranz)	A117
RCMX0000M0-RR	WSP (M Toleranz)	A154	SNMG000000-GK	WSP (M Toleranz)	A115
RKY00S	Schlüssel	N002	SNMG000000-GM	WSP (M Toleranz)	A115
RNGN000000	WSP (G Toleranz)	B049	SNMG000000-LK	WSP (M Toleranz)	A113
RNMG000000	WSP (M Toleranz)	A112	SNMG000000-LM	WSP (M Toleranz)	A113
RN-S0	Spannschraube	N006	SNMG000000-LP	WSP (M Toleranz)	A113
RS0000T	Spannschraube	N006	SNMG000000-MA	WSP (M Toleranz)	A115
RTG00A	WSP (Für TL Halter)	A176, C037	SNMG000000-MH	WSP (M Toleranz)	A115
<b>S</b>			SNMG000000-MK	WSP (M Toleranz)	A114
S0	Spannschraube	N006	SNMG000000-MM	WSP (M Toleranz)	A114
SBAHR0000	Halter Bohrstange	D030	SNMG000000-MP	WSP (M Toleranz)	A114
SBAT000000L	WSP (Für SBAHR Halter)	D030	SNMG000000-MS	WSP (M Toleranz)	A114, A115
SBAT000000L-B	WSP (Für SBAHR Halter)	D030	SNMG000000-RK	WSP (M Toleranz)	A116
SBH0000R	Halter (Für MICRO-DEX/MICRO-MINI Bohrstangen)	E026, F126, G029	SNMG000000-RM	WSP (M Toleranz)	A116
SCACR/L00000000-SM	Small Tools Halter (Aussen Längsdrehen)	D010	SNMG000000-RP	WSP (M Toleranz)	A116
SCLCR/L00000000	SP Halter	C024	SNMG000000-RS	WSP (M Toleranz)	A116
SCLCR/L00000000-SM	Small Tools Halter (Aussen Längsdrehen)	D010	SNMG000000-SA	WSP (M Toleranz)	A114
SCMT000000	WSP (M Toleranz)	A156	SNMG000000-SH	WSP (M Toleranz)	A113
SCMT000000-FM	WSP (M Toleranz)	A155	SNMG120408-SY	WSP (M Toleranz)	A114
SCMT000000-FP	WSP (M Toleranz)	A155	SNMM000000-HL	WSP (M Toleranz)	A117
SCMT000000-FV	WSP (M Toleranz)	A155	SNMM000000-HM	WSP (M Toleranz)	A117
SCMT000000-LM	WSP (M Toleranz)	A155	SNMM000000-HR	WSP (M Toleranz)	A117
SCMT000000-LP	WSP (M Toleranz)	A155	SNMM000000-HV	WSP (M Toleranz)	A117
SCMT000000-MK	WSP (M Toleranz)	A156	SNMM000000-HX	WSP (M Toleranz)	A117
SCMT000000-MM	WSP (M Toleranz)	A155	SNMM000000-HZ	WSP (M Toleranz)	A117
SCMT000000-MP	WSP (M Toleranz)	A155	SNMM250724-HXD	WSP (M Toleranz)	A118
SCMT000000-MS	WSP (M Toleranz)	A156	SNMN000000	WSP (M Toleranz)	A137, K035
SCMW000000	WSP (M Toleranz)	A156	SPGN000000	WSP (G Toleranz)	A178, B061, B075, K037
SD00	Schrauben	N006	SPGR090304R	WSP (G Toleranz)	A177
SDJCR/L00000000	SP Halter	C025	SPGX000000	WSP (G Toleranz)	A157, B068
SDJCR/L00000000-SM	Small Tools Halter (Aussen Längsdrehen)	D011	SPMN000000	WSP (M Toleranz)	A177, K037
SDJER/L00000015	AL Halter	C034	SPMN120304T	WSP (M Toleranz)	A177, K037
SDNCN000000	SP Halter	C025	SPMR000000	WSP (M Toleranz)	A177
SDNCR/L00000000-SM	Small Tools Halter (Aussen Längsdrehen)	D011	SPMR120308-80	WSP (M Toleranz)	A177
SDNEN00000015	AL Halter	C034	SPMT000000	WSP (M Toleranz)	A157
SETK00	Spannpratze	N016	SPMW000000	WSP (M Toleranz)	A157, J171, K038
SETS00	Spannschraube	N006	SPSVN32	Unterlegplatte	N013
SH000-FSDUCL00	SH Halter	D026	SPS1	Lokatorschraube	N006
SLCS0000	Spannschraube	N006	SRDCN00000000	SP Halter	C027
SL3200-90	Bohrstangenhülse	H022	SRGCR/L00000000	SP Halter	C027
SNGA000000	WSP (G Toleranz)	A118, B043	SRK1R	Spannpratze	N016
SNGG000000R/L	WSP (G Toleranz)	A116	SRS5	Spannschraube	N006
SNGN000000	WSP (G Toleranz)	A137, B050	S000SCLCR/L00	S Bohrstange (Stahlschaft)	E032
SNMA000000	WSP (M Toleranz)	A118	S000SCZCR/L00	S Bohrstange (Stahlschaft)	E036
SNMG000000	WSP (M Toleranz)	A115	S000SDQCR/L00	S Bohrstange (Stahlschaft)	E033
SNMG000000-FH	WSP (M Toleranz)	A113	S000SDUCR/L00	S Bohrstange (Stahlschaft)	E031
SNMG000000-FP	WSP (M Toleranz)	A113	SSSCR/L00000000	SP Halter	C028
			S000SSKCR/L00	S Bohrstange (Stahlschaft)	E035
			S000STFCR/L00	S Bohrstange (Stahlschaft)	E030

Bestellbezeichnung	PRODUKTNAME	Seite	Bestellbezeichnung	PRODUKTNAME	Seite
S <sup>0000</sup> STFER/L16	AL Bohrstange (Stahlschaft)	E041	TNGG <sup>00000000</sup> R/L	WSP (G Toleranz)	A123
S <sup>0000</sup> SVQCR/L <sup>00</sup>	S Bohrstange (Stahlschaft)	E034	TNGG <sup>00000000</sup> R/L-F	WSP (G Toleranz)	A119
S <sup>0000</sup> SVUCR/L <sup>00</sup>	S Bohrstange (Stahlschaft)	E035	TNGG <sup>00000000</sup> R/L-FS	WSP (G Toleranz)	A119
STASX <sup>0000</sup> N	Unterlegplatte	N013	TNGG <sup>00000000</sup> R/L-K	WSP (G Toleranz)	A121
STBS500N	Unterlegplatte	N013	TNGN <sup>00000000</sup>	WSP (G Toleranz)	A138, B050
STFER/L <sup>00000000</sup> 16	AL Halter	C035	TNMA <sup>00000000</sup>	WSP (M Toleranz)	A125
STGCR/L <sup>00000000</sup>	SP Halter	C029	TNMG <sup>00000000</sup>	WSP (M Toleranz)	A122
STGER/L <sup>00000000</sup> 16	AL Halter	C035	TNMG <sup>00000000</sup> -FH	WSP (M Toleranz)	A119
STS1	Schraube	N006	TNMG <sup>00000000</sup> -FP	WSP (M Toleranz)	A119
SVJBR/L <sup>00000000</sup> -SM	Small Tools Halter (Aussen Längsdrehen)	D012	TNMG <sup>00000000</sup> -FS	WSP (M Toleranz)	A119
SVJCR/L <sup>00000000</sup>	SP Halter	C030	TNMG <sup>00000000</sup> -FY	WSP (M Toleranz)	A119
SVJCR/L <sup>00000000</sup> -SM	Small Tools Halter (Aussen Längsdrehen)	D013	TNMG <sup>00000000</sup> -GH	WSP (M Toleranz)	A124
SVJDR/L <sup>00000000</sup> 16	AL Halter	C036	TNMG <sup>00000000</sup> -GK	WSP (M Toleranz)	A121
SVLPR/L <sup>00000000</sup> -SM	Small Tools Halter (Aussen Längsdrehen)	D012	TNMG <sup>00000000</sup> -GM	WSP (M Toleranz)	A122
SVPCR/L <sup>00000000</sup> 16	SP Halter	C031	TNMG <sup>00000000</sup> -LK	WSP (M Toleranz)	A120
SVPPR/L <sup>00000000</sup> -SM	Small Tools Halter (Aussen Längsdrehen)	D013	TNMG <sup>00000000</sup> -LM	WSP (M Toleranz)	A120
SVVBR/L <sup>00000000</sup> -SM	Small Tools Halter (Aussen Längsdrehen)	D013	TNMG <sup>00000000</sup> -LP	WSP (M Toleranz)	A120
SVVCN <sup>00000000</sup> 16	SP Halter	C030	TNMG <sup>00000000</sup> -LS	WSP (M Toleranz)	A120
SXZCR/L <sup>00000000</sup> 15	Profilhalter	C032	TNMG <sup>00000000</sup> -MA	WSP (M Toleranz)	A122
<b>T</b>			TNMG <sup>00000000</sup> -MH	WSP (M Toleranz)	A122
TBGN <sup>00000000</sup>	WSP (G Toleranz)	B062	TNMG <sup>00000000</sup> -MJ	WSP (M Toleranz)	A121
TCGN <sup>00000000</sup>	WSP (G Toleranz)	A179	TNMG <sup>00000000</sup> -MK	WSP (M Toleranz)	A121
TCGT <sup>00000000</sup> -AZ	WSP (G Toleranz)	A158	TNMG <sup>00000000</sup> -MM	WSP (M Toleranz)	A121
TCGT <sup>00000000</sup> MR/L-F	WSP (G Toleranz)	A141	TNMG <sup>00000000</sup> -MP	WSP (M Toleranz)	A121
TCGT <sup>00000000</sup> R/L-F	WSP (G Toleranz)	A158	TNMG <sup>00000000</sup> -MS	WSP (M Toleranz)	A121
TCGW <sup>00000000</sup>	WSP (G Toleranz)	B069	TNMG <sup>00000000</sup> -RK	WSP (M Toleranz)	A124
TCMT <sup>00000000</sup>	WSP (M Toleranz)	A160	TNMG <sup>00000000</sup> R/L-ES	WSP (M Toleranz)	A123
TCMT <sup>00000000</sup> -FM	WSP (M Toleranz)	A158	TNMG <sup>00000000</sup> R/L-2G	WSP (M Toleranz)	A123
TCMT <sup>00000000</sup> -FP	WSP (M Toleranz)	A158	TNMG <sup>00000000</sup> -RM	WSP (M Toleranz)	A123
TCMT <sup>00000000</sup> -FV	WSP (M Toleranz)	A158	TNMG <sup>00000000</sup> -RP	WSP (M Toleranz)	A123
TCMT <sup>00000000</sup> -LM	WSP (M Toleranz)	A159	TNMG <sup>00000000</sup> -RS	WSP (M Toleranz)	A124
TCMT <sup>00000000</sup> -LP	WSP (M Toleranz)	A159	TNMG <sup>00000000</sup> -SA	WSP (M Toleranz)	A120
TCMT <sup>00000000</sup> -LS	WSP (M Toleranz)	A159	TNMG <sup>00000000</sup> -SH	WSP (M Toleranz)	A120
TCMT <sup>00000000</sup> -MK	WSP (M Toleranz)	A159	TNMG <sup>00000000</sup> -SY	WSP (M Toleranz)	A121
TCMT <sup>00000000</sup> -MM	WSP (M Toleranz)	A159	TNMM <sup>00000000</sup> -HL	WSP (M Toleranz)	A124
TCMT <sup>00000000</sup> -MP	WSP (M Toleranz)	A159	TNMM <sup>00000000</sup> -HZ	WSP (M Toleranz)	A124
TCMT <sup>00000000</sup> -MS	WSP (M Toleranz)	A159	TNMN <sup>00000000</sup>	WSP (M Toleranz)	A138
TCMW <sup>00000000</sup>	WSP (M Toleranz)	A160, B069	TNMX <sup>00000000</sup> -MW	WSP (M Toleranz)	A123
TEGX <sup>00000000</sup>	WSP (Für AL Halter)	B060	TNMX <sup>00000000</sup> -SW	WSP (M Toleranz)	A120
TEGX <sup>00000000</sup> R/L	WSP (Für AL Halter)	A161, B073	TPGH <sup>00000000</sup> R/L-FS	WSP (G Toleranz)	A162
TIP <sup>0000</sup>	Schlüssel	N002	TPGN <sup>00000000</sup>	WSP (G Toleranz)	A181, B062, B075
TKY <sup>000</sup> D	Schlüssel	N002	TPGR <sup>00000000</sup> R/L	WSP (G Toleranz)	A180
TKY <sup>000</sup> F	Schlüssel	N002	TPGX <sup>00000000</sup>	WSP (G Toleranz)	A163, B070, K042
TKY <sup>000</sup> L	Schlüssel (lang)	N002	TPGX <sup>00000000</sup> R/L	WSP (G Toleranz)	A162, A163
TKY <sup>000</sup> R	L-Schlüssel	N002	TPMH <sup>00000000</sup> -FV	WSP (M Toleranz)	A162
TKY <sup>000</sup> T	T-Schlüssel	N002	TPMH <sup>00000000</sup> -MV	WSP (M Toleranz)	A163
TKY <sup>000</sup> W	Schlüssel	N002	TPMH <sup>00000000</sup> -SV	WSP (M Toleranz)	A163
TLHR <sup>00000000</sup>	TL Halter	C037	TPMN <sup>00000000</sup>	WSP (M Toleranz)	A180, K042
TNGA <sup>00000000</sup>	WSP (G Toleranz)	A125, B045, B065	TPMN220408T	WSP (M Toleranz)	A180, K042
			TPMR <sup>00000000</sup>	WSP (M Toleranz)	A180

# INHALTSVERZEICHNIS FÜR WERKZEUGBEZEICHNUNG

Bestellbezeichnung	PRODUKTNAME	Seite	Bestellbezeichnung	PRODUKTNAME	Seite
TPMR○○○○○○○-80	WSP (M Toleranz)	A180	VCMT○○○○○○○-LM	WSP (M Toleranz)	A167
TPMX○○○○○○○	WSP (M Toleranz)	A163	VCMT○○○○○○○-LP	WSP (M Toleranz)	A167
TPMX○○○○○○○L	WSP (M Toleranz)	A163	VCMT○○○○○○○-LS	WSP (M Toleranz)	A168
TPS○	Spannschraube	N008	VCMT○○○○○○○-MK	WSP (M Toleranz)	A169
TPS○○	Spannschraube	N008	VCMT○○○○○○○-MM	WSP (M Toleranz)	A168
TPS○○○	Spannschraube	N008	VCMT○○○○○○○-MP	WSP (M Toleranz)	A168
TPS○○○○	Spannschraube	N008	VCMT○○○○○○○-MS	WSP (M Toleranz)	A169
TPS○○○-1	Spannschraube	N008	VCMT○○○○○○○-MV	WSP (M Toleranz)	A169
TS○	Spannschraube	N007	VCMT○○○○○○○-SV	WSP (M Toleranz)	A168
TS○○	Spannschraube	N007	VCMW○○○○○○○	WSP (M Toleranz)	A169
TS○○○	Spannschraube	N007	VDGX○○○○○○○R-F	WSP (G Toleranz)	B074
TS○○○○	Spannschraube	N007	VDGX○○○○○○○R/L	WSP (G Toleranz)	A170
TSR○○○○○S	Spannschraube	N008	VNGA○○○○○○○	WSP (G Toleranz)	A129, B056
TSS○○○○○	Radialschraube	N008	VNGG○○○○○○○-FJ	WSP (G Toleranz)	A126
TSS○○○○○S	Spannschraube	N008	VNGG○○○○○○○R/L	WSP (G Toleranz)	A129
TTAHR/L○○○○○	Small Tools Halter		VNGG○○○○○○○R/L-F	WSP (G Toleranz)	A126
	(Aussengewinde Drehen)	D024	VNGM○○○○○○○-MJ	WSP (G Toleranz)	A127
TTAT○○○○○○○○○-B	WSP (Aussengewinde Drehen)	D024	VNMA○○○○○○○	WSP (M Toleranz)	A129
<b>U</b>			VNMG○○○○○○○	WSP (M Toleranz)	A128
UCR	Spannpratze	N016	VNMG○○○○○○○-FH	WSP (M Toleranz)	A126
<b>V</b>			VNMG○○○○○○○-FP	WSP (M Toleranz)	A126
VBET○○○○○○○R/L-SN	WSP (E Toleranz)	A166	VNMG○○○○○○○-FS	WSP (M Toleranz)	A126
VBET○○○○○○○R/L-SR	WSP (E Toleranz)	A166	VNMG○○○○○○○-GK	WSP (M Toleranz)	A128
VBET○○○○○○○R/LW-SN	WSP (E Toleranz)	A166	VNMG○○○○○○○-GM	WSP (M Toleranz)	A128
VBGT○○○○○○○R/L-F	WSP (G Toleranz)	A164	VNMG○○○○○○○-LK	WSP (M Toleranz)	A127
VBMT○○○○○○○	WSP (M Toleranz)	A165	VNMG○○○○○○○-LM	WSP (M Toleranz)	A126
VBMT○○○○○○○-FM	WSP (M Toleranz)	A164	VNMG○○○○○○○-LP	WSP (M Toleranz)	A126
VBMT○○○○○○○-FP	WSP (M Toleranz)	A164	VNMG○○○○○○○-LS	WSP (M Toleranz)	A127
VBMT○○○○○○○-FV	WSP (M Toleranz)	A164	VNMG○○○○○○○-MA	WSP (M Toleranz)	A128
VBMT○○○○○○○-LM	WSP (M Toleranz)	A164	VNMG○○○○○○○-MH	WSP (M Toleranz)	A128
VBMT○○○○○○○-LP	WSP (M Toleranz)	A164	VNMG○○○○○○○-MJ	WSP (M Toleranz)	A127
VBMT○○○○○○○-LS	WSP (M Toleranz)	A165	VNMG○○○○○○○-MK	WSP (M Toleranz)	A127
VBMT○○○○○○○-MK	WSP (M Toleranz)	A165	VNMG○○○○○○○-MP	WSP (M Toleranz)	A127
VBMT○○○○○○○-MM	WSP (M Toleranz)	A165	VNMG○○○○○○○-MS	WSP (M Toleranz)	A128
VBMT○○○○○○○-MP	WSP (M Toleranz)	A165	VNMG○○○○○○○-SA	WSP (M Toleranz)	A127
VBMT○○○○○○○-MS	WSP (M Toleranz)	A165	VNMG○○○○○○○-SH	WSP (M Toleranz)	A127
VBMT○○○○○○○-MV	WSP (M Toleranz)	A165	VNMG160408-MM	WSP (M Toleranz)	A127
VBMT○○○○○○○-SV	WSP (M Toleranz)	A165	VPET○○○○○○○-SRF	WSP (E Toleranz)	A171
VBMW160408	WSP (M Toleranz)	A166	VPGT○○○○○○○M-SMG	WSP (G Toleranz)	A171
VCGT○○○○○○○-AZ	WSP (G Toleranz)	A167	<b>W</b>		
VCGT○○○○○○○M-LS	WSP (G Toleranz)	A168	WBGTT○○○○○○○R/L-F	WSP (G Toleranz)	A172
VCGT○○○○○○○M-LS-P	WSP (G Toleranz)	A168	WBMT○○○○○○○R/L-MV	WSP (M Toleranz)	A172
VCGT○○○○○○○R/L-F	WSP (G Toleranz)	A167	WCGT○○○○○○○R/L	WSP (G Toleranz)	A173
VCGW1103○○	WSP (G Toleranz)	B071	WCMT○○○○○○○	WSP (M Toleranz)	A173
VCMT○○○○○○○	WSP (M Toleranz)	A169	WCMW06T304	WSP (M Toleranz)	B072
VCMT○○○○○○○-FM	WSP (M Toleranz)	A167	WCS○○○○○○○H	Schraube	N008
VCMT○○○○○○○-FP	WSP (M Toleranz)	A167	WNMA○○○○○○○	WSP (M Toleranz)	A134
VCMT○○○○○○○-FV	WSP (M Toleranz)	A167	WNMG○○○○○○○	WSP (M Toleranz)	A133
			WNMG○○○○○○○-FH	WSP (M Toleranz)	A130

Bestellbezeichnung	PRODUKTNAME	Seite	Bestellbezeichnung	PRODUKTNAME	Seite
WNUMG○○○○○○○-FP	WSP (M Toleranz)	A130			
WNUMG○○○○○○○-FS	WSP (M Toleranz)	A130			
WNUMG○○○○○○○-FY	WSP (M Toleranz)	A130			
WNUMG○○○○○○○-GH	WSP (M Toleranz)	A134			
WNUMG○○○○○○○-GJ	WSP (M Toleranz)	A134			
WNUMG○○○○○○○-GK	WSP (M Toleranz)	A133			
WNUMG○○○○○○○-GM	WSP (M Toleranz)	A133			
WNUMG○○○○○○○-LK	WSP (M Toleranz)	A131			
WNUMG○○○○○○○-LM	WSP (M Toleranz)	A130			
WNUMG○○○○○○○-LP	WSP (M Toleranz)	A130			
WNUMG○○○○○○○-LS	WSP (M Toleranz)	A131			
WNUMG○○○○○○○-MA	WSP (M Toleranz)	A133			
WNUMG○○○○○○○-MH	WSP (M Toleranz)	A133			
WNUMG○○○○○○○-MJ	WSP (M Toleranz)	A131			
WNUMG○○○○○○○-MK	WSP (M Toleranz)	A132			
WNUMG○○○○○○○-MM	WSP (M Toleranz)	A132			
WNUMG○○○○○○○-MP	WSP (M Toleranz)	A132			
WNUMG○○○○○○○-MS	WSP (M Toleranz)	A132			
WNUMG○○○○○○○-MW	WSP (M Toleranz)	A133			
WNUMG○○○○○○○-RK	WSP (M Toleranz)	A134			
WNUMG○○○○○○○-RM	WSP (M Toleranz)	A133			
WNUMG○○○○○○○-RP	WSP (M Toleranz)	A133			
WNUMG○○○○○○○-RS	WSP (M Toleranz)	A134			
WNUMG○○○○○○○-SA	WSP (M Toleranz)	A131			
WNUMG○○○○○○○-SH	WSP (M Toleranz)	A131			
WNUMG○○○○○○○-SW	WSP (M Toleranz)	A131			
WNUMG○○○○○○○-SY	WSP (M Toleranz)	A131			
WPGT○○○○○○○	WSP (G Toleranz)	B072			
WPGT○○○○○○○R/L-FS	WSP (G Toleranz)	A174			
WPMT○○○○○○○-MV	WSP (M Toleranz)	A174			
WPSTN○○○	Unterlegplatte	N013			
WPSWC43	Unterlegplatte	N013			
WPSWN43	Unterlegplatte	N013			
WS○○○○○○○T	Spannschraube	N008			
WS○○○○○○○TPS	Spannschraube	N008			
<b>X</b>					
XCMT○○○○○○○-SVX	WSP (M Toleranz)	A175			





# WELTWEIT

## **MITSUBISHI MATERIALS CORPORATION - METALWORKING SOLUTIONS COMPANY GEMEINSAM ZUM ERFOLG**

Der Geschäftsbereich Metalworking Solutions des Mitsubishi Materials Konzerns widmet sich der Herstellung und Bearbeitung von Metallen, Schneidstoffen, Beschichtungen und Präzisionswerkzeugen. Mit fundiertem Know-how und langjähriger Erfahrung in der Fertigungstechnik gehört Mitsubishi Materials zu den führenden Anbietern in diesem Marktsegment.

Die globale Marktpräsenz des Unternehmens mit Hauptgeschäftsstellen und Vertriebsgesellschaften in Japan, Europa, Indien, Brasilien, China, Thailand, Mexiko und den USA sowie mit einem breiten Netzwerk von internationalen Handelspartnern sorgt für einen flächendeckenden, zielgerichteten Service.

Informationsaustausch und Technologietransfer, offene Kommunikation und wachsende Synergien über Grenzen hinweg garantieren maximale Leistung und einen dauerhaften Kundenerfolg.

# METALWORKING SOLUTIONS COMPANY

---







**GERMANY**

MMC HARTMETALL GMBH  
Comeniusstr. 2 . 40670 Meerbusch  
Phone +49 2159 91890 . Fax +49 2159 918966  
Email admin@mmchg.de

**U.K.**

MMC HARDMETAL U.K. LTD.  
Mitsubishi House . Galena Close . Tamworth . Staffs. B77 4AS  
Phone +44 1827 312312 . Fax +44 1827 312314  
Email sales@mitsubishicarbide.co.uk

**SPAIN**

MITSUBISHI MATERIALS ESPAÑA, S.A.  
Calle Emperador 2 . 46136 Museros/Valencia  
Phone +34 96 1441711 . Fax +34 96 1443786  
Email comercial@mmevalencia.es

**FRANCE**

MMC METAL FRANCE S.A.R.L.  
6, Rue Jacques Monod . 91400 Orsay  
Phone +33 1 69 35 53 53 . Fax +33 1 69 35 53 50  
Email mmfsales@mmc-metal-france.fr

**POLAND**

MMC HARDMETAL POLAND SP. Z O.O  
Al. Armii Krajowej 61 . 50 - 541 Wrocław  
Phone +48 71335 1620 . Fax +48 71335 1621  
Email sales@mitsubishicarbide.com.pl

**ITALY**

MMC ITALIA S.R.L.  
Viale Certosa 144 . 20156 Milano  
Phone +39 0293 77031 . Fax +39 0293 589093  
Email info@mmc-italia.it

**TURKEY**

MMC HARTMETALL GMBH ALMANYA - İZMİR MERKEZ ŞUBESİ  
Adalet Mahallesi Anadolu Caddesi No: 41-1 . 15001 35530 Bayraklı/İzmir  
Phone +90 232 5015000 . Fax +90 232 5015007  
Email info@mmchg.com.tr